

BAHAMA[®]

Event



Bahama

Founded in 1950 today Bahama designs and manufactures a great variety of high-quality large-size parasols and sun sails. National and International customers alike trust in our industrial technology and accurate workmanship. The premium products from Bahama characteristically stand for technical attributes like compactness, durability and wind stability but also for aesthetical features like beautiful designs and materials.

»Made in Germany« – our full range production facility manufactures nearly all parts in house. Bahama further processes sustainable and environmentally friendly materials according to the OEKO-TEX 100 standard, Class 1. The combination of high-quality materials and the structural features allows Bahama to guarantee wind stability for its products, depending on the model, of up to 130 km/h.

And most importantly: we love customer service – from consulting to installation, from cleaning to winter storage and maintenance.

Discover the possibilities of an extended outdoor season. No matter what the weather. Just get to know us!

The Heart of it All

Event can be found in our product range between »small« like Easy and »large« like Jumbrella. It was designed for our customers, who prefer a large-size parasol at a fair price but don't need the variety of features or combination possibilities offered with Jumbrella. Event is our entry-level model with our maintenance-free servo mechanism for opening and closing. Due to its steeper angle, in comparison to other models, this parasol is suited perfectly for advertising purposes. The printing on the parasol's membrane is clearly visible from every angle, thereby ensuring optimal advertising presence.

- * 9 different standard sizes of the textile membranes from 6,25 m² to 19 m²
- * Round and square models
- * Elegant lightweight
- * Low price despite professional features
- * Maintenance-free servo mechanism for trouble-free opening and closing
- * Energy efficient handling with the servo-mechanism
- * Optimal fabric tension due to handle with spring buckle
- * Telescopic opening and closing for increased ground clearance
- * No loose functional parts like ropes, cranks or connectors
- * Standard frame in traffic white | RAL 9016, glossy finish
- * High-quality textile fabric
- * Large, contemporary selection of colors
- * Absolutely waterproof
- * Excellent UV-protection UPF 50+
- * Numerous possibilities for printing on the textile membranes and/or valances
- * Short delivery times, fast spare parts delivery, lifelong spare parts supply
- * Optional impact protection

Waterproof...

BAHAMA®



Product Information

1 Textile Membranes

No matter your choice of fabric, the resulting textile membranes combine all the attributes of a durable and sustainable product. These include next to the high-quality appearance numerous technical functions.

1.1. Brand Name: betex®05 | Fabric exclusively crafted for Bahama

100% Polyester fabric with top transparent coating

Grammage of approx. 200 g/m²

Excellent UV-protection UPF 50+ protects against UV radiation (exception: snow 9577)

High degree of fabric lightfastness (i.e. fading) (DIN EN ISO 105-B02 Class ≥ 6-7)

High waterproofness, pressure resistance (DIN EN 20811, ISO 811 | Water column ≥ 100 mbar, 1.000 mm)

Low moisture absorption, dries quickly

High temperature resistance (DIN 53361 from -30°/+90°C)

Excellent friction resistance (DIN EN ISO 105-x12 | Class ≥ 4-5)

High tear resistance due to high thread count

Durable, tailor-made and dimensionally stable with perfect membrane tension

Sustainable and environmentally friendly fabrics with the OEKO-TEX 100 Standard, Class 1

Exchangeable and washable, one-piece membranes

25 contemporary colors according to the color chart



2 Umbrella Frame

The difference may not be obvious at first sight: but it is easier to stand on two legs. For this reason, the large-size parasols from Bahama have an inner and an outer pole that optically come together to form one. Better sturdiness also means better stability and the corresponding safety.

Center Pole with Outer and Inner Pole

Octagonal, welded hollow aluminum profile

Pole diameter approx. 67 mm

Wall thickness approx. 1.5 mm

Rounded-off corners (fabric friendly, no fraying)

Standard frame color in traffic white | RAL 9016, glossy finish

PES powder-coated center pole, post-baked

Spring buckle and tension rod made of V2A stainless steel

Easy and quick opening and closing

Spokes, Support Spokes, Bearings and Hinges

The quality of a parasol can only be as good as its supporting and connecting parts.

Aluminum rectangular profiles with rounded corners 24/18, 29/18 or 36/18 mm*

Aluminum profiles made of alloy F30/32

V2A-reinforced steel axis joints

Individually exchangeable spare parts

*depending on model



Product Information



3 Installation Options

There is a choice of mobile or permanent installation options. Mobile installation is characterized by a greater degree of flexibility in choosing the location and surface. When installing an in-ground option, building measures must be carried out that have to be taken into consideration during the planning phase. They consist of above-ground and in-ground pieces to be set in concrete.

3.1. Mobile Installation Options

I. Portable Stand

Hot-dip galvanized steel frame

Including 8 standard flagstones

Height adjustability in all 4 corners; standard

Weight: approx. 155 - 235 kg, depending on size

II. Cross-Frame

Hot-dip galvanized steel frame

Suitable for 8 standard flagstones
400 × 400 × 50 mm, 500 × 500 × 50 mm respectively
(not included in the price)

Height adjustability in all 4 corners (picture II)

Size of cross-frame: approx. 890 × 890 mm,
approx. 1090 × 1090 mm

Weight of cross-frame:
890 × 890 mm, approx. 19.5 kg
1090 × 1090 mm, approx. 24.2 kg



Sizes of the portable stands/cross-frames

for ø 3 m ø 3,5 m ø 4 m 2.5 × 2.5 m 3 × 3 m 3.5 × 3.5 m	890 × 890 mm, approx. 19.5 kg
for ø 4.5 m ø 5 m 4 × 4 m	1090 × 1090 mm, approx. 24.2 kg

III. Steel Plate Base with 4 or 8 Steel Plates | 2 Layers

Flat construction with only 15 mm installation height;
no tripping hazard

Hot-dip galvanized plates

Screw-on receiving column (rigid)

Plate size: 490 × 490 × 15 mm (ea. 28 kg) | 2 layers

For above-ground use 8 steel plates are needed;
weight approx. 237 kg

OPTIONAL

Powder-coating in traffic white | RAL 9016, glossy
finish

Spacer height min. 89 mm - max. 350 mm or starting
at a height of 351 mm e.g. for terrace substructures
(picture III.1)

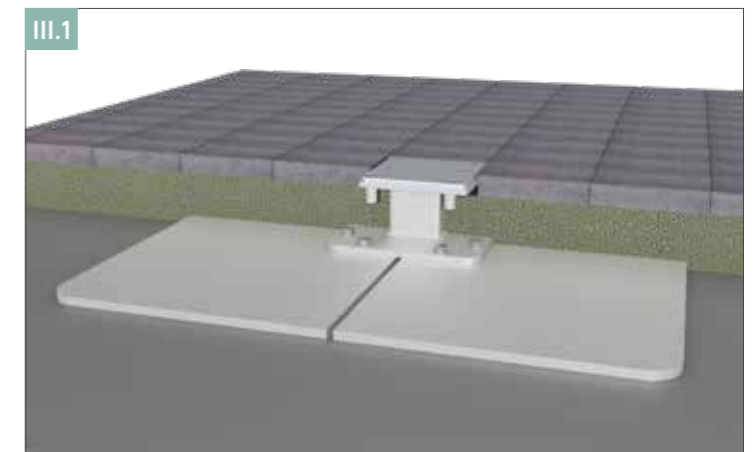

Product Information



3.2. Permanent Installation Options

I. In-Ground Sleeve

Sleeve to be set in concrete

Above-ground connecting components

Hot-dip galvanized, welded steel

Weight: approx. 7.1 kg

OPTIONAL

In-ground installation extension for bridging a gap e.g. an installation in a kindergarten sandbox; height order-based starting at a min. 89 mm to 400 mm (picture I.1)

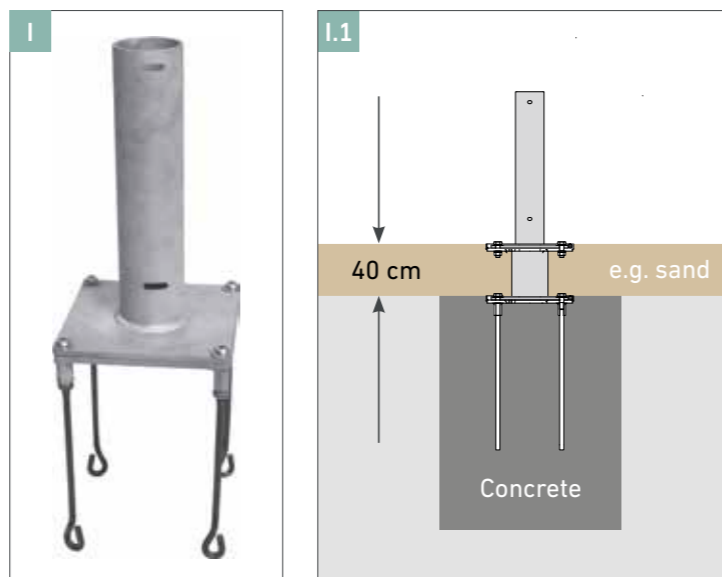

II. Octagonal Surface Mount with Counter-Bores

Hot-dip galvanized and powder-coated steel

Powder-coated receiving column is welded on to surface mount

Weight: approx. 18 kg

Suited for bolting onto massive concrete ground or bolting onto massive timber planks

OPTIONAL

»fischer« heavy-duty anchoring bolts (1 set =8 pcs.); type #FH II 15/15 SK A4; M10 thread; incl. concrete drill type #SDS Plus II, drill depth 105 mm and Allen wrench SW 6



III. Connecting Plate for »Krinner« Ground Screw

Suitable for »Krinner« KSF F 140x2100-M no setting in concrete, screw-in foundation

Rigid, galvanized; weight approx. 6.5 kg

Screw-on receiving column

Especially suited for loose surfaces, e.g. kindergarten sandboxes

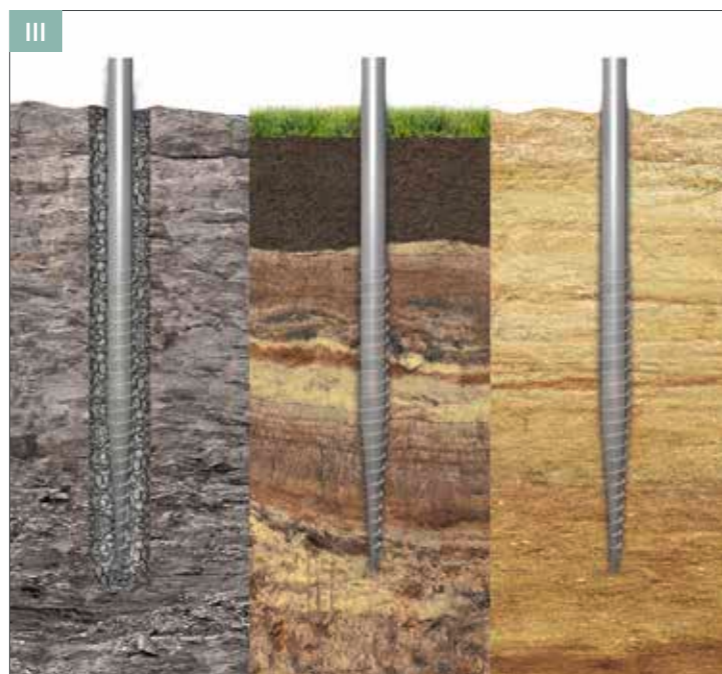

Additional Features

1 Valance

The valance is hemmed, dyed in the matching color and the edgelines are thermally processed. No ruffles here.

Valance height approx. 30 cm

Additional advertising space



2 Printing

The Bahama UV printer uses 9 color channels. Even pure white. Only lightfast and highest quality inks are used to ensure color accurate fonts, logos and emblems are positioned with millimeter precision.

No fading due to highly UV-resistant colors

Optimal advertising impact



References: Mc Donalds, Starbucks, Heineken, Carlsberg, Bitburger, Gaffel, Café & Bar Celona, Café Extrablatt, Hilton, Kempinski et al.

3 Protective Cover

Not only does it keep everything together, it also keeps it clean. Film packaging is often not enough protection. To this end there are – especially for winter or long-term storage – robust protective covers in different versions.

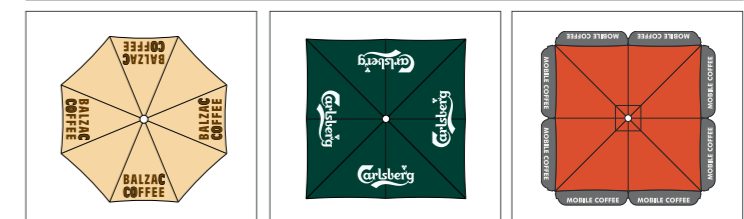

Protective Cover basic

Light weather protection cover (picture 3.1)

Tent fabric | Nicotarp with lacing

Protective Cover comfort

Robust weather protection cover (picture 3.2)

»betex®05« | Polyester | 9801 – concrete

With zipper for telescopic rod

Protective Cover comfort with Telescopic Rod

Equipped with telescopic rod. When ordering more than one cover, only one telescopic rod is necessary.

Easy to put over the parasol



Additional Features



4 Impact Protection

Metal or soft padding? Some questions answer themselves, when it comes to eliminating a potential source of injury (e.g. kindergartens or retirement homes).

Colorful soft foam safeguard; available in 10 colors

Cuff with soft foam on the inside

Outer material made of polyester fabric with PVC coating

With Velcro fasteners



5 Theft Protection and Authorized Use

You wouldn't park your high-end bicycle without locking it up first, right? Protect your parasol from theft with a lock that is incorporated in the installation option. Further, a cylindrical lock in the handle prevents unauthorized use (opening and closing) of the parasol.

Lock in Handle (included with delivery)

1 Cylindrical lock inside the handle (picture 5.1)

Prevention of unauthorized opening and closing

Easy to use

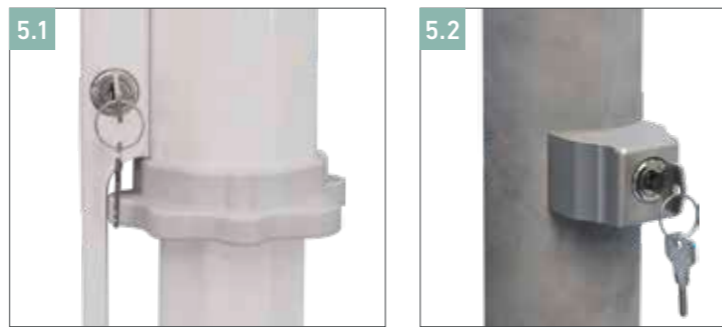

Additional Lock (optional)

Theft protection (picture 5.2)

Incorporated in the installation option



6 Transport Packaging (included with delivery)

The parasols leave our production facility in perfect condition. To ensure they arrive in perfect condition they are delivered in a hard-cardboard cylinder tube.

Outer diameter approx. 67 mm*

Cylinder length approx. 3,850 bis 4,180 mm*

Weight excluding parasol up to 16 kg*

*depending on model

Handling

Opening, tensioning and closing is quick and easy.

OPENING

- Take off the safety strap. Lift the ends of the spokes until the parasol opens by itself.
- Latch in the spring buckle and press the handle down. (picture 1).

CLOSING

- Lift handle up and unlatch the spring buckle.
- After completely closing the parasol (final position) press handle down onto the pole. (passive position).
- Pull the tips of the fabric to the outside of closed parasol and spirally wrap them around the center pole (Picture 2).
- Wrap the safety strap around the parasol (picture 3).

The excellent appearance and the technical features of the textile membrane can be maintained by adhering to the following closing procedures:

Always pull the tips of the fabric to the outside of a closed parasol

Do not store the parasol with any fabric stuck in between the spokes and support spokes



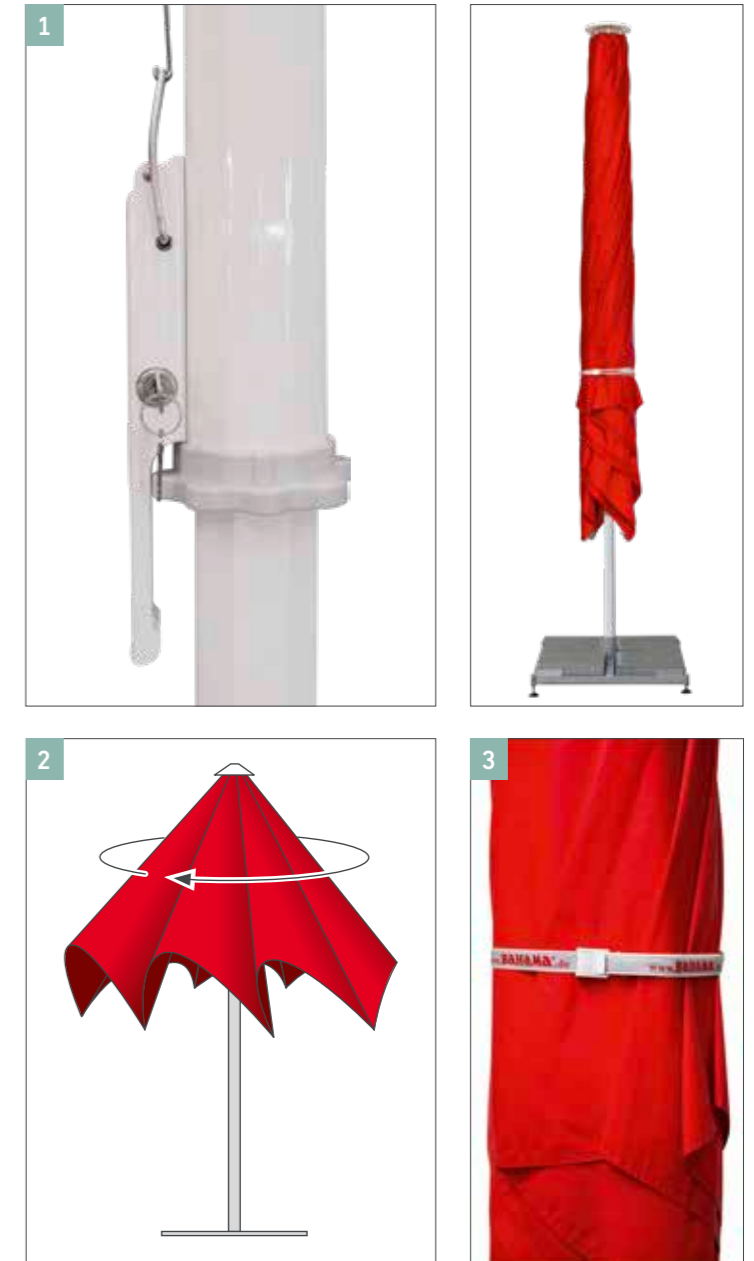

Spirally wrap the fabric around the center pole and spokes (picture 2)



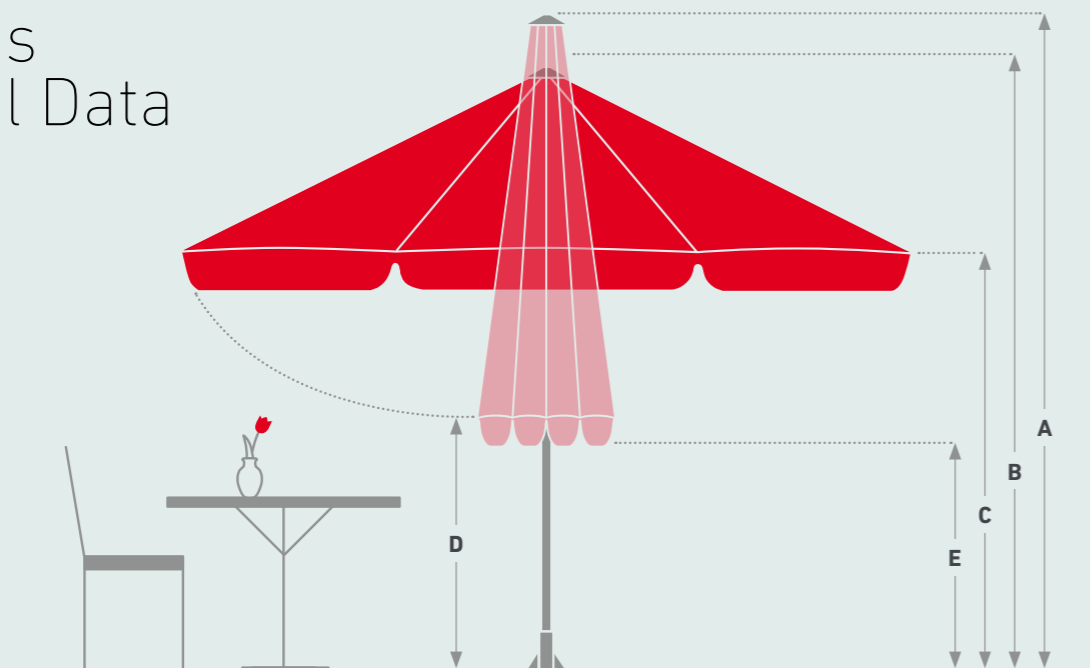

Wrap the safety strap around the parasol to secure the fabric (picture 3)



Dimensions & Technical Data



All measurements are approximate.	 Ø 3.0 m 8 Spokes	 Ø 3.5 m 8 Spokes	 Ø 4.0 m 8 Spokes	 Ø 4.5 m 8 Spokes	 Ø 5.0 m 8 Spokes
Area in m ²	7	9	12	15	19
Parasol weight in kg	23	26	31	35	40
Transport weight incl. packaging, in kg	35	39	42	46	51
A Height closed* in cm	357	367	377	387	397
B Height opened* in cm	312	322	332	342	352
C Passage height* in cm	228	227	226	227	224
D Ground clearance* in cm	183	166	149	132	115
E Ground clearance* in cm when using a valance	153	136	119	102	85
Max. permitted wind velocities fully opened parasol, km/h Permanent/Mobile	85/64	80/60	74/56	65/49	60/45

All measurements are approximate.	 2.5 × 2.5 m 8 Spokes	 3.0 × 3.0 m 8 Spokes	 3.5 × 3.5 m 8 Spokes	 4.0 × 4.0 m 8 Spokes
Area in m ²	6,25	9	12	16
Parasol weight in kg	21	26	31	36
Transport weight incl. packaging, in kg	33	38	40	49
A Height closed* in cm	343	357	367	377
B Height opened* in cm	302	312	322	332
C Passage height* in cm	228	228	227	226
D Ground clearance* in cm	149	126	102	73
E Ground clearance* in cm when using a valance	119	96	72	43
Max. permitted wind velocities fully opened parasol, km/h Permanent/Mobile	95/71	70/53	65/49	60/45

* All measurements refer to the use with a permanent installation option (in-ground sleeve).

Good to know

Sustainability and Environmental Compatibility

The »betex®05« fabric, exclusively crafted for Bahama, and the resulting textile membrane are certified exclusively according to the OEKO-TEX 100 standard, Class 1 which is awarded by independent institutions. Class 1 meets the demands of baby clothing with skin contact.

The OEKO-TEX pollutant test corresponds to the respective intended use of the textiles and materials. In Germany there are clear and reliable criteria for environmental compatibility and sustainability. Bahama demands of its products that every defect or damaged part can be replaced.

Made in Germany

Bahama's customers always refer back to the great importance of our German production facilities. »Made in Germany« is still a unique selling point and a reason to buy. Bahama's full range production facility is located in Germany.

The combination of the highest quality materials and structural features allows Bahama to guarantee the wind stability of its products, depending on the model, up to 130 km/h. In addition to the technical details of the parasol structure, it is the decisiveness of the textile membranes' color to light-fastness, waterproof material, weight and water column that make each Bahama parasol the highest quality in its class. Trust is placed in Bahama by luxury hotels such as the Burj Al Arab in Dubai, the Hotel Sacher in Vienna and the Dalí Museum in St. Petersburg, USA.

Service

Service greatly influences the life span of a parasol. The exchangeable textile membrane of a Bahama parasol can – after being exposed to all sorts of weather conditions for years – be cleaned or replaced. Our service makes a full technical and general overhaul of the product such that they not only look attractive, but can defy the strongest of winds.

No matter where you need Bahama's service, the Bahama team or one of our expert partners will be glad to help - worldwide.

Careful and individual planning

Installation of new parasols

Fitting of new textile membranes

Complete service i.e. assembling and disassembling the large-size parasols, washing, cleaning and maintenance of the frame and textile membranes

Membrane service, i.e. fitting and removing the textile membrane, cleaning and repairing

Storage of the returned and serviced large-size parasols and/or textile membranes.

Technical trainings

UV-Protection

Analogous to the sun protection factor/SPF all textiles are labeled with the ultraviolet protection factor/UPF. Built into the fabric it protects against hazardous UV radiation. Bahama uses the fabric brand betex®05 for the production of its parasol textile membranes. This material fulfills the requirements for UPF 50+, which indicates an »excellent« dermatological UV protection factor and allows less than one fiftieth (<2%) of the UV radiation through the textile membrane onto the skin.



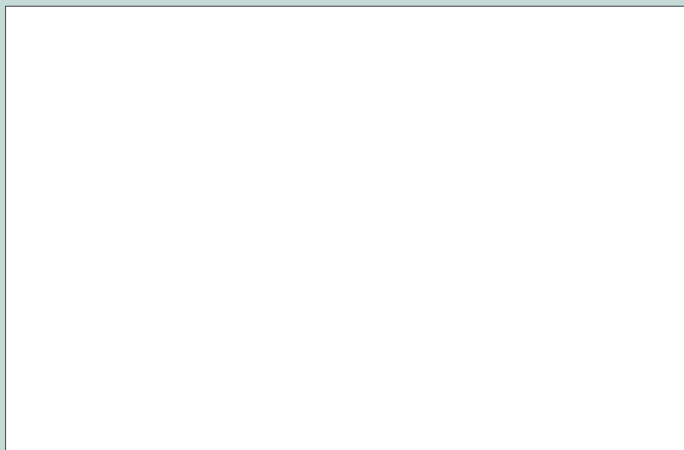

01/2021

BAHAMA®