

outdoor 2019 / 2020

tecnopolimeri - alluminio - acciaio



since 1957

1957-2017

60 ANNI DI MADE IN ITALY

Nel 2017 SCAB ha festeggiato i suoi primi 60 anni di attività e di successi nel mondo del design, un traguardo importante, per un'azienda che è diventata un punto di riferimento nell'arredo in ambito nazionale e internazionale. Dalla prima sedia completamente stampata in materiale termoplastico, all'ultimo modello lanciato, emergono i valori di SCAB - trasversalità della gamma prodotti, qualità, design democratico, prezzi competitivi e costante entusiasmo per la ricerca e l'innovazione - che il suo team di architetti, designer, ingegneri e consulenti interpretano ogni giorno. SCAB ha una storia fatta di creatività e di passione che rende onore al Made in Italy in tutte le sue espressioni, culminata del conferimento del Cavaliato al Merito della Repubblica Italiana al suo Patron, Francesco Battaglia.

60 YEARS OF MADE IN ITALY

In 2017 SCAB has celebrated its first 60 years of activity and successes in the world of design, an important milestone for a company that has become a landmark in furnishings at both a national and international level. From the first chair completely made of thermoplastic material right up to the last model launched, emerge the values of SCAB - the transversal nature of the product range, quality, democratic design, competitive prices and constant enthusiasm for research and innovation - which our team of architects, designers, engineers and consultants interpret every day. SCAB's history is made of creativity and passion that honors the Made in Italy brand in all its expressions, culminating in the award of Knighthood of the Order of Merit of the Italian Republic given to its Patron, Francesco Battaglia.



Cavalier Francesco Battaglia

Patron e Amministratore delegato della società SCAB dal 1957
Since 1957 chief and Managing Director



SCAB sede/headquarters - Coccaglio (BS) Italy



SCAB 3 - Coccaglio (BS) Italy



SCAB Rudiano (BS) Italy

85.000 m²

DI PRODUZIONE MADE IN ITALY

La produzione SCAB
è da sempre completamente italiana, grazie a 3 unità produttive
di proprietà, dislocate in tutto il Nord Italia,
che ricoprono 85.000 m²
Tutti i prodotti in tecnopolimero sono
realizzati con 30 presse robotizzate
da operatori esperti, coniugando le più moderne tecnologie
con l'amore e la cura per il dettaglio di un'antica
tradizione artigianale.

*85,000 sq. m.
OF MADE IN ITALY PRODUCTION*

*SCAB's production has always been completely Italian, thanks
to its 3 owned production sites, located in northern Italy, covering
85,000 Sq m. All the technopolymer
products are made using 30 robotic presses run by expert
operators, combining the latest technology with the love and
attention to detail
of an ancient artisan tradition.*



UTILIZZIAMO IL MEGLIO PER DARVI IL MEGLIO

Non puoi dire qualità senza usare queste lettere: S C A B.
Progettiamo e produciamo tutti i nostri prodotti in Italia.
Una garanzia per il cliente di materiali superiori e di una
lavorazione allo stato dell'arte.

TECNOPOLIMERO: DALLA NATURA E DALLA
RICERCA SCAB
IL MATERIALE D'AVANGUARDIA PER IL COMFORT
ALL'APERTO.

Il tecnopolimero è un composto costituito da materiali pla-
stici di origine organica e da materiali minerali.
Riceve dai primi la caratteristica di poter essere modellato
sotto l'azione
del calore, ed una eccezionale resistenza agli agenti
atmosferici.

Dai materiali minerali riceve la stabilità, la rigidità,
la notevole robustezza.

La plasticità ha consentito alle avanzate tecniche
di stampaggio Scab di unire alle linee di un design
d'autore tutto il comfort derivato da precisi studi
ergonomici.

Stabilità e consistenza sono espressi in un rapporto ideale
tra peso e robustezza.

L'aggiunta di anti-U.V.A., coloranti e trattamenti
antistatici, garantisce l'aspetto estetico
e l'inalterabilità agli agenti atmosferici
(compresi muffe, smog, polvere).

Infine il coefficiente di conducibilità particolarmente basso
consente ai prodotti Scab di restare a lungo
al sole senza assorbire calore.

Per ridare loro splendore, dopo una stagione
all'aperto, basta un colpo di spugna con acqua e sapone
liquido neutro, evitando i prodotti abrasivi
e a base di cloro ed i solventi.

Il tecnopolimero, grazie alla sua origine naturale,
è un materiale ecologico, riciclabile al 100%.

Tutta la produzione Scab è realizzata solo con
tecnopolimeri di prima qualità.

WE USE THE BEST TO GIVE YOU THE BEST

*You really can't say quality without those letters: S C A B.
We design and produce all our products in Italy.
A guarantee for the customer of first grade materials and state
of the art manufacture.*

*TECNOPOLYMER: A HIGHLY ADVANCED MATERIAL
PROVIDED BY NATURE AND SCAB RESEARCH FOR
OUTDOOR COMFORT.*

*The technopolymer is a compound consisting of plastic
materials of organic origin and materials
deriving from minerals. As a result of the first of the two
materials mentioned above,
the technopolymer can be molded under heat and it is
extremely resistant to atmospheric agents.*

*The materials of mineral origin give the technopolymer its
outstanding characteristics of stability, strength and its
remarkable sturdiness. Due to the plasticity of the material
and the advanced moulding techniques used at Scab, it has
become possible to combine stylish design with all the
comfort deriving from careful ergonomic studies.*

*Stability and durability are expressed in an ideal ratio between
weight and sturdiness.*

*The technopolymer is U.V.A. stabilized and with the addition
of colourants and anty-static treatments, its appearance is
guaranteed to remain unaltered, while it is also resistant to
atmospheric agents (including mould, smog and dust).
Lastly, the particularly low coefficient of conductivity means
that Scab products can be left under the sun for long periods
without absorbing heat. To restore the brightness of the
furniture after a season in the open, just wipe with a sponge
using water and neutral liquid soap.*

*Avoid the use of abrasive products and those containing
chlorine, or solvents.*

*Thanks to its natural origin, technopolymer is an ecological
material. It can be completely recycled.*

*The whole Scab production range is made from the finest
quality technopolymer.*



INDICE

OUTDOOR
TECNOPOLIMERI E ALLUMINIO

pag. 7

IMBOTTITI,
ALLUMINIO E ACCIAIO

pag. 51

OUTDOOR

TECNOPOLIMERI E ALLUMINIO

PRODOTTI FABBRICATI IN ITALIA
PRODUCT MADE IN ITALY



VELA

DESIGN GIANLUCA PASOTTI

EU registered design

Vela è il lettino da sole impilabile che reinventa le regole del relax. Elegante e funzionale ha un design essenziale che lo rende un arredo perfetto per i contesti outdoor, come spiagge e bordo piscina. Ha un telaio in tecnopolimero di ultima generazione arricchito con fibra di vetro e stampato con tecnica air moulding, schienale regolabile, telo reversibile e facilmente ricambiabile, ed è dotato di ruote integrate.

Vela is a stackable sun bed that reinvents the rules for relaxation. Elegant and functional, it has an understated design which means it fits seamlessly into outdoor areas, adorning beaches and pool sides. It has a frame made with the latest generation of technopolymer enriched with glass fibre, with injection moulded using "Air moulding" technology, adjustable back, reversible and quick-change cover, and equipped with wheels.



Art. 2044-2 10 T10
bianco - telo bianco
white - white cover



Art. 2044-2 10 T60
bianco - telo blu
white - blue cover



Art. 2044-2 10 T15
bianco - telo tortora
white - dove grey cover

ruote integrate
equipped with wheels



Art. 2044-2 15 T10
tortora - telo bianco
dove grey - white cover



Art. 2044-2 15 T15
tortora - telo tortora
dove grey - dove grey cover



Art. 2044-2 81 T81
antracite - telo antracite
anthracite grey - anthracite grey cover



T10
bianco / white

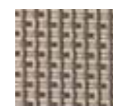

T15
tortora / dove grey



T60
blu / blue



T81
antracite / anthracite grey

Il telo facilmente ricambiabile è in tessuto sintetico, traspirante, idrorepellente, indeformabile, resistente ai raggi UV, termosaldato, facile da pulire, lavabile con acqua e sapone.

The quick-change fabric cover is synthetic, breathable, water-repellent, non-deformable, UV-resistant, thermally welded, easy to clean, washable with soap and water.



impilabile - stackable



Conforme EN 581-2:2015
Compliant with EN581-2:2015



2044-2 15 T15
tortora - telo tortora
dove grey - dove grey cover

TAHITI

DESIGN CENTRO STILE SCAB
EU registered design

ELEGANZA - SEMPLICITA' - FUNZIONALITA'

Letino Tahiti è l'ultima generazione del lettino da sole di design. La struttura è ergonomica, confortevole, maneggevole e resistente, grazie alla tecnologia di stampaggio con iniezione a gas e al tecnopolimero di ultima generazione arricchito con fibra di vetro.

*ELEGANCE - SIMPLICITY - FUNCTIONALITY
Letino Tahiti is the latest generation of the design sun lounger. The structure is ergonomic, comfortable, easy to handle, and sturdy, thanks to the gas injection moulding technology and the latest generation of technopolymer enriched with glass fibre.*

2043-2 15 T15
tortora - telo tortora
dove grey - dove grey cover

2043-2 15 T10
tortora - telo bianco
dove grey - white cover

2043-2 81 T81
antracite - telo antracite
anthracite grey - anthracite grey cover

CATAS Conforme EN 581-2:2015
Compliant with EN581-2:2015



schienale regolabile in 5 posizioni
backrest adjustable in 5 positions



facile da spostare grazie alle ruote integrate
easy to move thanks to the integrated wheels



impilabile
stackable



la sostituzione del telo è facile e veloce
the fabric replacement is simple and fast

2043-2 10 T60
bianco - telo blu
white - blue cover

2043-2 10 T15
bianco - telo tortora
white - dove grey cover

2043-2 10 T10
bianco - telo bianco
white - white cover



T10
bianco / white

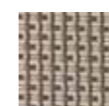

T15
tortora / dove grey



T60
blu / blue



T81
antracite / anthracite grey

Il telo è in tessuto sintetico, traspirante, idrorepellente, indeformabile, resistente ai raggi UV, termosaldato, facile da pulire, lavabile con acqua e sapone.

The fabric is synthetic, breathable, water-repellent, non-deformable, UV-resistant, thermally welded, easy to clean, washable with soap and water.

GINEVRA

DESIGN CENTRO STILE SCAB F. B.

Ginevra, con o senza braccioli integrati, regala un comfort d'eccellenza. La struttura in tecnopolimero ne permette l'utilizzo sia in spazi d'incontro e pubblici che nel giardino di casa. Tutti i modelli Ginevra sono impilabili.

Ginevra with or without armrests represents exceptional comfort. The technopolymer frame means it can be used both in public meeting places and in the garden at home. All the Ginevra models can be stacked.



Art. 2333 15
tortora - dove grey

Art. 2334 73
terracotta
terracotta

Art. 2333 11
lino - linen

Art. 2334 51
verde pistacchio
light green

Art. 2333 81
antracite
anthracite grey

Art. 2334 22
senape
yellow mustard

Art. 2333 62
azzurro - light blue

Art. 2334 42
rosso geranio
geranium red

SUNSET

DESIGN LUISA BATTAGLIA

Poltrona impilabile ampia e confortevole.

Classica ed elegante nella sua silhouette a doghe, è un abbinamento ideale per i nuovi tavoli Scab.

Struttura in tecnopolimero rinforzato fibra di vetro.

A roomy and comfortable stackable armchair.

With its classic and elegant slatted design, it is a perfect match for all Scab new tables.

Technopolymer structure, reinforced with glass fibre.



2329 11
lino - linen

2329 15
tortora - dove grey

2329 81
antracite - anthracite grey

2329 42
rosso geranio - geranium red

2329 86
grafite - graphite

2329 62
azzurro - light blue



poltrona / armchair
SUNSET
2329 11

PER 3
1893 AV 11

PER 3

ALLUNGABILE DA 170 A 220 CM.

DESIGN CENTRO STILE SCAB

Per3, con piano in tecnopolimero a effetto doghe e gambe in alluminio verniciato, si estende in lunghezza da 170 a 220 cm. con 2 prolunghe per una convivialità da vivere all'aria aperta.

Grazie a volumi equilibrati e forme nette, arreda con moderna eleganza gli ambienti outdoor.

Le prolunghe lo rendono complemento ideale e versatile per tutte le occasioni, formali e informali.

Per3, with a technopolymer slatted top and coated aluminium legs, can be extended in length from 170 to 220 cm. with 2 extensions for dining in the open air.

The balanced size and clean lines of this table bring a touch of modern elegance to outdoor settings.

The extensions makes it very versatile, ideal for all formal and informal occasions.





poltrona / armchair
SUNSET
2329 15

ERCOLE 170x100
2145 15

ERCOLE

DESIGN CENTRO STILE SCAB

ERCOLE

Dalla forma elegante, robusta ed essenziale è un richiamo alla storia e al valore delle cose realizzate con qualità.

È un tavolo per esterni realizzato completamente in tecnopolimero con piano a effetto doghe, che arreda ogni ambiente con raffinatezza e sobrietà.

Resistente agli agenti atmosferici è facile da mantenere e da pulire.

Trova in giardini, dehors e bordo piscina la location perfetta per ospitare cene di famiglia o tra amici.

ERCOLE

With an elegant, robust, and essential form, it is a reminder of history and the value of things made with quality.

It is an outdoor table made completely of technopolymer with a parquet-effect tabletop, which furnishes every space with elegance and simplicity.

It is weatherproof and easy to maintain and clean. Found in gardens, terraces, and poolside, it is the perfect location to host family dinners or with friends.

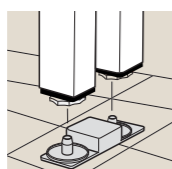

Kit staffe di aggancio
Linking device kit
2942 001

TAVOLO ERCOLE
MISURA 170X100 CM
AFFIANCABILE ALL'INFINITO (DA 170 A 340 CM E SUCCESSIVI MULTIPLI)
E' la componibilità il suo punto di forza.
E' possibile allineare perfettamente più tavoli senza sprechi di spazio o penalizzazione dei posti a sedere.

ERCOLE TABLE
SIZE: 170X100 CM
ALIGN IT AD INFINITUM (FROM 170 CM, 340, AND MULTIPLE ONES...)
Modularity is its advantage.
Several tables can be aligned perfectly without wasting space or sacrificing seating.

LUCREZIA

DESIGN CENTRO STILE SCAB



Poltroncina impilabile in polipropilene effetto intrecciato. Rinforzato con fibra di vetro. Disponibile con o senza braccioli. Adatta a tutte le situazioni outdoor.

Stackable armchair in polypropylene, woven effect. Reinforced with fiberglass. Available with or without armrests. Suitable for all outdoor settings.

poltrona / armchair
LUCREZIA
2322 15 SF

sedia / chair
LUCREZIA
2323 15 SF

tavolo / table
ORAZIO
2189 15



OLIMPO SOFA & OLIMPIA TREND

DESIGN CENTRO STILE SCAB



OLLY

74 x 56 H.44

CATAS

Conforme EN 15373:2007
Compliant with EN 15373:2007

OLIMPIA TREND
2279 15 SF

OLLY
2195 15

OLIMPO SOFA
1252-99 15

Divano, poltrona e tavolino intrecciati in tecnopolimero, gambe in alluminio con cover intrecciata in tecnopolimero.

A settee an armchair and a side table with a woven pattern body in technopolymer, and aluminium legs covered in woven pattern technopolymer.

ESMERALDA LUX

DESIGN CENTRO STILE SCAB



ESMERALDA LUX
2067 81 T16

ESMERALDA LUX
2067 81 T15

Poltrona chiudibile con struttura in tecnopolimero e seduta e schienale in tessuto traspirante idrorepellente. Schienale regolabile in 5 posizioni

This folding armchair has a technopolymer frame and a seat and back in breathable waterproof fabric. The backrest can be adjusted to 5 different positions.



OLIMPIA & DODO OLIMPO

DESIGN CENTRO STILE SCAB



DODO OLIMPO 70x70
1898 AA 11

OLIMPIA
2277 AA 11 SF

CATAS

Conforme EN 15373:2007
Compliant with EN 15373:2007

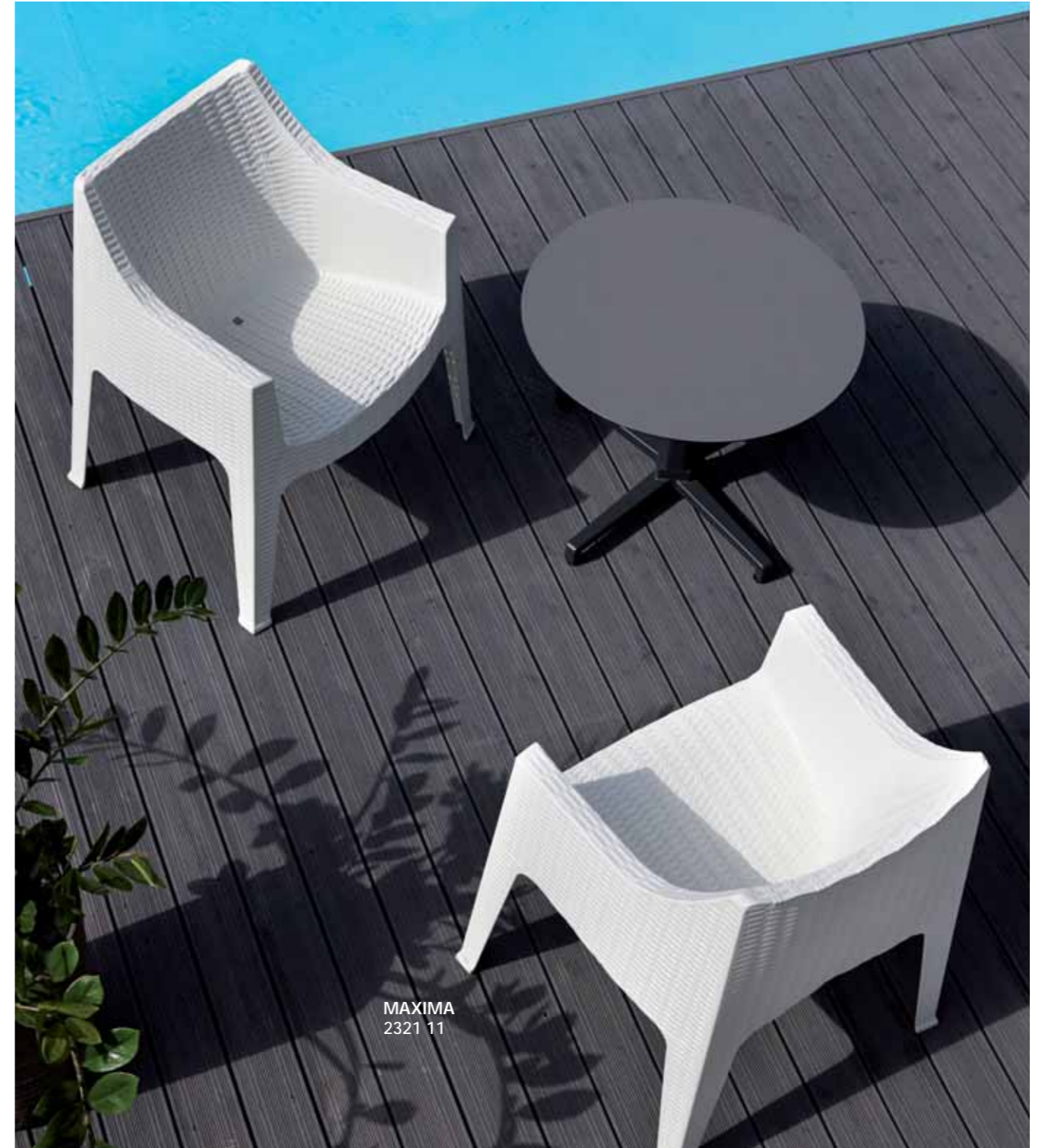

MAXIMA
2321 11

CATAS

Conforme EN 15373:2007
Compliant with EN 15373:2007

POLTRONA INTRECCIATA



tavolo / table
INTRECCIATO 140x80
1047

poltrona / armchair
INTRECCIATA
1170 SF

TAVOLO INTRECCIATO



tavolo / table
INTRECCIATO 80x80
1023

poltrona / armchair
INTRECCIATA
1172 SF



particolare della superficie del piano
detail of the table top

STELLA DI MARE®

DESIGN MARK ROBSON



QUADROMAX
CONTRACT 80x80
1012

STELLA DI MARE®
1186

TIUANA



TIUANA
1123

DADDY CONTRACT 70x70
977

SCIROCCO 2000

Dondolo 3 posti
in tecnopolimero - smontabile
con portabibite - tettino tessuto acrilico

3-seater swing hammock
in technopolymer - can be disassembled
with drink holder - acrylic fabric canopy

Viterie in
ACCIAIO INOX

Screws in
STAINLESS STEEL



SCIROCCO 2000
1246

Una piccola scatola
per un grande dondolo!

A little box for a great
swing hammock!

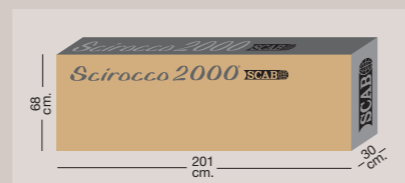

JASPER

Dondolo 3 posti
in tecnopolimero - smontabile
con portabibite - tettino tessuto acrilico

3-seater swing hammock
in technopolymer - can be disassembled
with drink holder - acrylic fabric canopy

Parti metalliche in
alluminio

Viterie in
ACCIAIO INOX

Metal components made of
ALUMINIUM
Screws in
STAINLESS STEEL



JASPER
1251

MAXI BOX

CONTENITORE MULTIUSO

Per il giardino e la casa si presta ad una infinità di usi. Ideale per l'esterno, può contenere i cuscini delle sdraio e dei lettini. Con fori di aerazione e due comode maniglie.

Munito ad una estremità di ruote per facilitarne gli spostamenti.

Ha una capienza veramente notevole.

CUSHION BOX

Maxi box is suitable for infinite uses.

It is ideal for outside, it may contain the cushions of your deckchairs and of your sun-beds.

Equipped with airing holes and two comfortable handles.

On one side wheels will make shifting easier.

It has a very remarkable capacity!

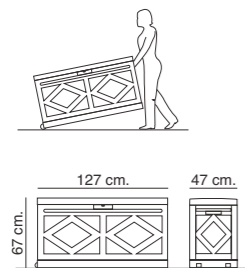

MAXI BOX
2111



MAXI BOX
2114



MAXI BOX
2110

Misure e fantasie dei tessuti sono indicative. La SCAB si riserva il diritto di apportare modifiche o varianti senza preavviso. Tutti i modelli SCAB sono depositati. The sizes and fabric patterns are given as way of an example. SCAB reserves the right to make any changes or alterations without prior notice. All the models are registered.

PERLAGE

CARRELLO PORTABIBITE CHIUDIBILE

FOLDABLE DRINK TROLLEY



PERLAGE
1264



PERLAGE
1261

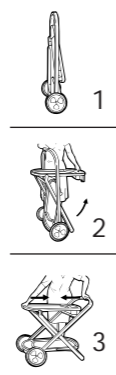

MADE IN ITALY

PRODOTTI FABBRICATI IN ITALIA
PRODUCT MADE IN ITALY



ESPRESSIONE CHE QUALIFICA IL SISTEMA
MANIFATTURIERO ITALIANO
SECONDO ECCELLENZA, ALTA
SPECIALIZZAZIONE DELLE TECNICHE
DI PRODUZIONE, CONTESTO DI SVILUPPO
E REALIZZAZIONE DEI PRODOTTI SPESSO
DI CARATTERE DISTRETTUALE.

EXPRESSION THAT QUALIFIES THE ITALIAN
MANUFACTURING SYSTEM
ACCORDING TO EXCELLENCE, HIGH
SPECIALIZATION OF PRODUCTION
TECHNIQUES, CONTEXT OF DEVELOPMENT,
AND CREATION OF PRODUCTS OFTEN OF
DISTRICT CHARACTER.

TAVOLI SMONTABILI tables - can be disassembled

PER 3 TAVOLO ALLUNGABILE
DA CM.170 A 220 CON 2 PROLUNGHE

Piano in tecnopolimero.
Gambe quadrate in alluminio verniciato da mm. 70x70.

EXTENDIBLE TABLE FROM 170 TO 220 CM WITH 2 EXTENSIONS
Top in technopolymer.
Square 70x70 mm coated aluminium legs.



Art. 1893 AV 11
lino - linen



Art. 1893 AV 15
tortora - dove grey



Art. 1893 AV 81
antracite - anthracite grey



particolare della superficie del piano
detail of the table top

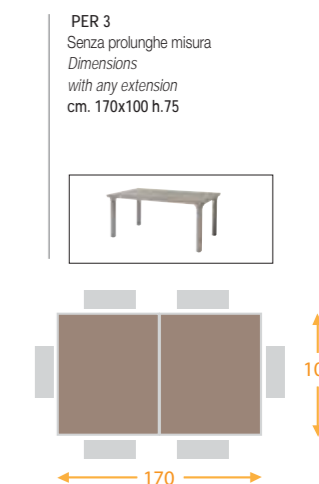
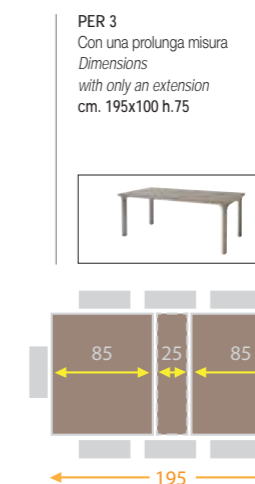
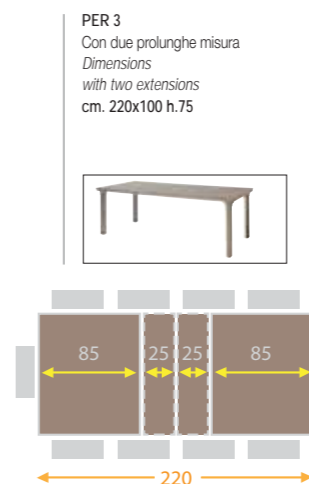
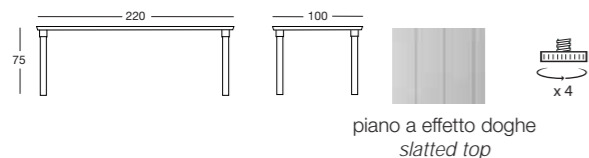

Le prolunghe quando non utilizzate,
si ripongono sotto al piano, fissate agli appositi ganci.
*The extensions, when not in use, are folded under the surface,
fixed to the special hooks.*

ERCOLE 170x100

Piano e gambe in tecnopolimero, con rinforzi sottopiano in acciaio zincato. Gambe quadrate.
Top and legs in technopolymer, with galvanized steel underlay reinforcements. Square legs.



Art. 2145 11
lino - linen



Art. 2145 15
tortora - dove grey



Art. 2145 81
antracite - anthracite grey



particolare della superficie del piano
detail of the table top

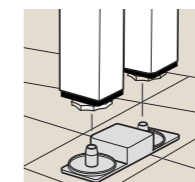

Kit staffe di aggancio
Linking device kit
Art. 2942 001

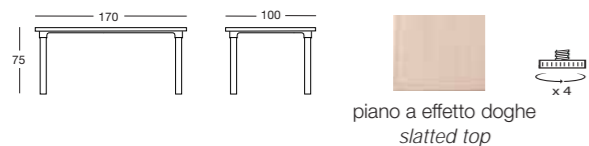

PRESIDENT TRIS 1700-1950-2200

ALLUNGABILE / extendible



Art. 971
bianco - white



Art. 976
tortora - dove grey



Art. 972
verde bosco - forest green

PRESIDENT TRIS
Con due prolunghe misura
Dimensions
with two extensions
cm. 220x95 h.73

PRESIDENT TRIS
Con una prolunga misura
Dimensions
with only an extension
cm. 195x95 h.73

PRESIDENT TRIS
Senza prolunghe misura
Dimensions
with any extension
cm. 170x95 h.73



PRESIDENT 1800



Art. 957
bianco - white



Art. 958
verde bosco - forest green



TAVOLI CHIUDIBILI *foldable tables*

RIBALTO 160x90 Contract
piano ribaltabile - *inclining table top*



Art. 1853
bianco - *white*

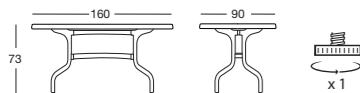

Art. 1854
verde bosco - *forest green*

RIBALTO 140x80 Contract
piano ribaltabile - *inclining table top*



Art. 1859
bianco - *white*

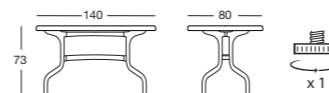

Art. 1860
verde bosco - *forest green*

RIBALTO ø 95 Contract
piano ribaltabile - *inclining table top*



Art. 1823
bianco - *white*

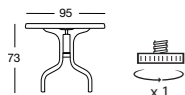

RIBALTO 80x80 Contract
piano ribaltabile - *inclining table top*



Art. 1829
bianco - *white*

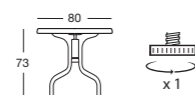

Art. 1831
antracite - *anthracite grey*



Art. 1830
verde bosco - *forest green*

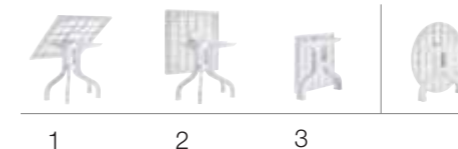

Ribalto, con facilità si apre e si chiude.

Ribalto si apre e si chiude con pochi semplici movimenti, così può essere quotidianamente ripiegato e riposto occupando il minimo ingombro. Versatile: ideale per bar, ristoranti, balconi, terrazze e giardini.

Ribalto, open and closes with ease.

With just a few simple moves, this table opens and closes so that it can be folded and tucked away on a daily basis thus being of minimum encumbrance. Versatile: ideal for bars, restaurants, balconies, terraces and gardens.

TAVOLI SMONTABILI *tables - can be disassembled*

BOSS ø 95 Contract



Art. 1040
bianco - *white*

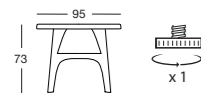

RETTANGO Contract



Art. 1067
bianco - *white*

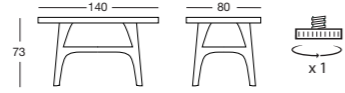

Art. 1061
verde bosco - *forest green*

QUADROMAX Contract



Art. 1015
bianco - *white*

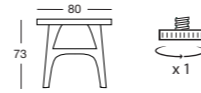

Art. 1012
tortora - *dove grey*



Art. 1066
verde bosco - *forest green*

DADDY Contract 70x70



Art. 963
bianco - *white*

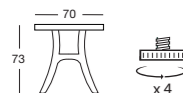

Art. 977
tortora - *dove grey*



Art. 962
antracite - *anthracite grey*



Art. 964
verde bosco - *forest green*

DADDY Contract 60x60



Art. 946
bianco - *white*

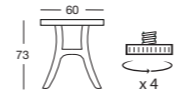

Art. 948
verde bosco - *forest green*

POL ø 80 Contract



Art. 967
bianco - *white*



Art. 968
verde bosco - *forest green*

POL ø 70 Contract



Art. 951
bianco - *white*

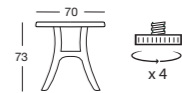

Art. 953
verde bosco - *forest green*

TAVOLI SMONTABILI tables - can be disassembled

ELLE 80x80

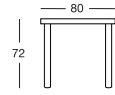

Art. 1033
bianco - white



Art. 1036
tortora - dove grey



Art. 1025
verde bosco - forest green

TAVOLINI SMONTABILI small tables - can be disassembled

TIP h. 38



Art. 1022
bianco - white



Art. 1024
tortora - dove grey



Art. 1030
verde bosco - forest green

DONDOLI swing hammocks

SCIROCCO 2000

dondolo 3 posti
in tecnopolimero - smontabile
con portabibite - tettino tessuto acrilico

3-seater swing hammock
in technopolymer - can be disassembled
with drink holder - acrylic fabric canopy

Viterie in

ACCIAIO INOX

Screws in

STAINLESS STEEL

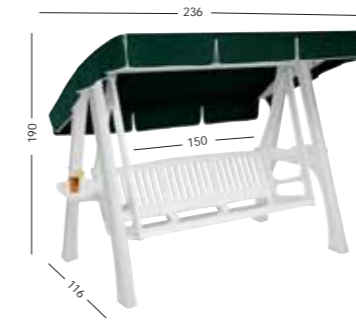

Art. 1246
bianco / tettino verde
white / green canopy

JASPER

dondolo 3 posti
in tecnopolimero - smontabile
con portabibite - tettino tessuto acrilico

3-seater swing hammock
in technopolymer - can be disassembled
with drink holder - acrylic fabric canopy

Parti metalliche in

alluminio

Viterie in

ACCIAIO INOX

Metal components made of

ALUMINIUM

Screws in

STAINLESS STEEL

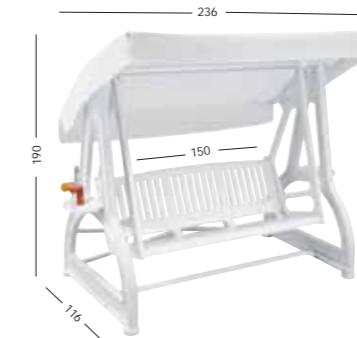

Art. 1251
bianco - white

**CUSCINO UNICO PER DONDOLI TECNOPOLIMERO
single cushion for technopolymer swing hammocks**



cotone
cotton



Art. 1542

105
drill



imbottitura mm. 30
padding 30 mm.

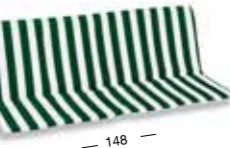

Art. 1531

350



imbottitura mm. 30
padding 30 mm.

- colori freschi, luminosi, brillanti
- bello, pratico ed elegante
- è naturale, è cotone

- fresh, luminous and bright colours
- nice, comfortable and elegant
- naturally, it is cotton

ORAZIO 70x70



piano e gambe in tecnopolimero effetto intrecciato
woven patterned technopolymer top and legs



Art. 2189 11
lino - *linen*



Art. 2189 15
tortora - *dove grey*



Art. 2189 70
bronzo - *bronze*



Art. 2189 81
antracite - *anthracite grey*

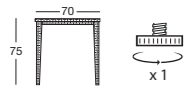

OLIMPO 80x80

piano ribaltabile in tecnopolimero - gambe in alluminio
inclining technopolymer table top - aluminium legs



piano effetto intrecciato
woven patterned top



Art. 2197 70
bronzo - gambe verniciate
bronze - coated legs



Art. 2197 81
antracite - gambe verniciate
anthracite grey - coated legs

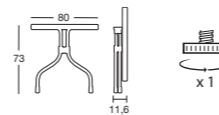

TAVOLO INTRECCIATO 140x80



piano e gambe in tecnopolimero effetto intrecciato
woven patterned technopolymer top and legs



Art. 1046
lino - *linen*



Art. 1047
tortora - *dove grey*



Art. 1048
bronzo - *bronze*



Art. 1049
antracite - *anthracite grey*

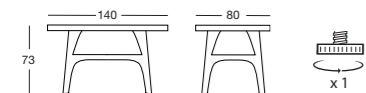

TAVOLO INTRECCIATO 80x80



piano e gambe in tecnopolimero effetto intrecciato
woven patterned technopolymer top and legs



Art. 1018
lino - *linen*



Art. 1019
tortora - *dove grey*



Art. 1021
bronzo - *bronze*



Art. 1023
antracite - *anthracite grey*

OLLY h.44



piano e gambe effetto intrecciato
woven patterned top and legs



Art. 2195 11
lino - *linen*



Art. 2195 15
tortora - *dove grey*



Art. 2195 81
antracite - *anthracite grey*



TAVOLO DODO OLIMPO 70x70

piano in tecnopolimero con parabola sottopiano - colonna in alluminio anodizzato - base a quattro piedi in polipropilene e ghisa
technopolymer top with under arch - anodised aluminum column - four feet base in polypropylene and cast iron



piano effetto intrecciato
woven patterned top



Art. 1898 AA 11
lino - *linen*



Art. 1898 AA 15
tortora - *dove grey*



Art. 1898 AA 70
bronzo - *bronze*



Art. 1898 AA 81
antracite - *anthracite grey*

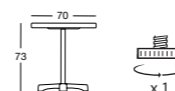

LETTINI DA SOLE *sun beds*

VELA

lettino da sole impilabile con ruote - struttura in tecnopolimero e fibra di vetro - viterie in acciaio inox - regolabile in 5 posizioni
stackable sun bed with wheels - technopolymer and glass fibre frame - stainless steel screws - 5 position adjustable back

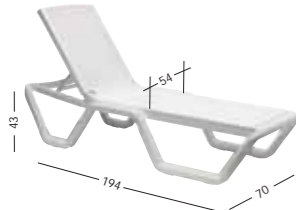

Art. 2044-2 10 T10
 bianco - telo bianco
white - white cover



Art. 2044-2 10 T60
 bianco - telo blu
white - blue cover



Art. 2044-2 10 T15
 bianco - telo tortora
white - dove grey cover



Art. 2044-2 15 T10
 tortora - telo bianco
dove grey - white cover



Art. 2044-2 15 T15
 tortora - telo tortora
dove grey - dove grey cover



Art. 2044-2 81 T81
 antracite - telo antracite
anthracite grey - anthracite grey cover



Conforme EN 581-2:2015
 Compliant with EN581-2:2015

TELI DI RICAMBIO LETTINI TAHITI E VELA
REPLACEMENT COVER FOR TAHITI AND VELA SUN BEDS
 Reversibile e ricambiabile con facilità
Reversible, simple and quick to change



Art. 1521 T10
 bianco - *white*



Art. 1521 T60
 blu - *blue*



Art. 1521 T15
 tortora - *dove grey*



Art. 1521 T81
 antracite - *anthracite grey*

TAHITI

lettino da sole impilabile con ruote - struttura in tecnopolimero e fibra di vetro - viterie in acciaio inox - regolabile in 5 posizioni
stackable sun bed with wheels - technopolymer and glass fibre frame - stainless steel screws - 5 position adjustable back

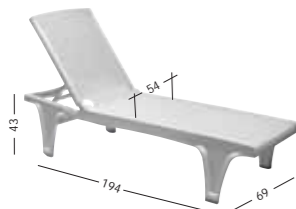

Art. 2043-2 10 T10
 bianco - telo bianco
white - white cover



Art. 2043-2 10 T60
 bianco - telo blu
white - blue cover



Art. 2043-2 10 T15
 bianco - telo tortora
white - dove grey cover



Art. 2043-2 15 T10
 tortora - telo bianco
dove grey - white cover



Art. 2043-2 15 T15
 tortora - telo tortora
dove grey - dove grey cover



Art. 2043-2 81 T81
 antracite - telo antracite
anthracite grey - anthracite grey cover



Conforme EN 581-2:2015
 Compliant with EN581-2:2015

TESSUTO TRASPIRANTE IDROREPELLENTE

Il Tessuto Traspirante Idrorepellente è realizzato con filato di poliestere rivestito da PVC e termosaldato. Questo tessuto offre un'eccezionale resistenza agli agenti atmosferici, è particolarmente adatto all'utilizzo esterno ed è lavabile con acqua e sapone.

WATER-REPELLENT BREATHABLE FABRIC

The water-repellent, breathable fabric has been created using polyester yarn coated in PVC and heat sealed. This fabric offers excellent resistance to atmospheric agents, is particularly suitable for outdoor use and can be washed using soap and water.

SMERALDO TEX

lettino da sole con ruote - regolabile in 5 posizioni - chiudibile
sun bed with wheels - 5 position adjustable back - foldable



Art. 2034
 bianco - telo grigio perla
white - pearl grey cover



Art. 2019
 tortora - telo bianco
dove grey - white cover



Art. 1244
 bianco - *white*



Art. 1245
 verde bosco - *forest green*

STELLA DI MARE®

lettino da sole con ruote - regolabile in 5 posizioni - chiudibile
sun bed with wheels - 5 position adjustable back - foldable

STELLA DI MARE® Contract

impilabile / *stackable*
 lettino da sole con ruote - regolabile in 5 posizioni
sun bed with wheels - 5 position adjustable back



Art. 1243
 bianco - *white*

CASABLANCA

impilabile / *stackable*
 lettino da sole con ruote - regolabile in 5 posizioni
sun bed with wheels - 5 position adjustable back



Art. 1255-16
 bianco - *white*

CALIFORNIA

lettino da sole con ruote - regolabile in 5 posizioni - chiudibile
sun bed with wheels - 5 position adjustable back - foldable



Art. 1257
 bianco - *white*



Art. 1263
 tortora - *dove grey*



Art. 1258
 verde bosco - *forest green*

SPLENDIDO

lettino da sole con ruote - regolabile in 5 posizioni - chiudibile
sun bed with wheels - 5 position adjustable back - foldable



Art. 2025
 bianco - *white*



Art. 2026
 verde bosco - *forest green*

PIEGHEVOLI *folding, chairs and armchairs*

ESMERALDA LUX 5 posizioni
poltrona 5 posizioni - chiudibile
5 position armchair - foldable



Art. 2067 81 T15
antracite - telo tortora
anthracite grey - dove grey cover



Art. 2067 81 T16
antracite - telo miele
anthracite grey - honey cover



Art. 2067 10 T10
bianco - telo bianco
white - white cover



CLEOPATRA CON PROLUNGA
poltrona con prolunga - regolabile in 5 posizioni - chiudibile
armchair with extension - 5 position adjustable back - foldable



Art. 1124
bianco - *white*

QUINTILLA CON PROLUNGA
poltrona con prolunga - regolabile in 5 posizioni - chiudibile
armchair with extension - 5 position adjustable back - foldable



Art. 1138
bianco - *white*



Art. 1139
verde bosco - *forest green*

CLEOPATRA 5 posizioni
poltrona 5 posizioni - chiudibile
5 position armchair - foldable



Art. 1125
bianco - *white*



Art. 1154
verde bosco - *forest green*

QUINTILLA 5 posizioni
poltrona 5 posizioni - chiudibile
5 position armchair - foldable

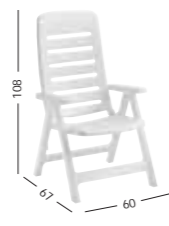

Art. 1135
bianco - *white*



Art. 1132
verde bosco - *forest green*

SPLENDIDA 5 POSIZIONI
poltrona 5 posizioni - chiudibile
5 position armchair - foldable



Art. 1990
bianco - *white*

PERLAGE
carrello portabibite - chiudibile
drink trolley - foldable



Art. 1264
bianco - *white*



Art. 1261
verde bosco - *forest green*

ESMERALDA TEX 5 posizioni
poltrona 5 posizioni - chiudibile
5 position armchair - foldable

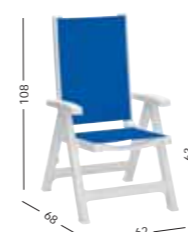

Art. 2073
bianco - telo blu
white - blue cover



Art. 2070
bianco - telo bianco
white - white cover



TESSUTO TRASPIRANTE IDROREPELLENTE

Il Tessuto Traspirante Idrorepellente è realizzato con filato di poliestere rivestito da PVC e termosaldato. Questo tessuto offre un'eccezionale resistenza agli agenti atmosferici, è particolarmente adatto all'utilizzo esterno ed è lavabile con acqua e sapone.

WATER-REPELLENT BREATHABLE FABRIC

The water-repellent, breathable fabric has been created using polyester yarn coated in PVC and heat sealed. This fabric offers excellent resistance to atmospheric agents, is particularly suitable for outdoor use and can be washed using soap and water.

CALIFORNIA 5 posizioni
poltrona 5 posizioni - chiudibile
5 position armchair - foldable



Art. 1129
bianco - *white*



Art. 1130
verde bosco - *forest green*

ELEGANT 5 posizioni
poltrona 5 posizioni - chiudibile
5 position armchair - foldable



Art. 1100
bianco - *white*



Art. 1103
tortora - *dove grey*



Art. 1101
verde bosco - *forest green*

CLEOPATRA 5 posizioni
poltrona 5 posizioni - chiudibile
5 position armchair - foldable



Art. 1125
bianco - *white*



Art. 1154
verde bosco - *forest green*

QUINTILLA 5 posizioni
poltrona 5 posizioni - chiudibile
5 position armchair - foldable

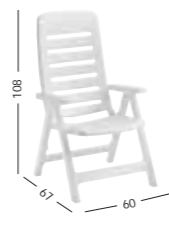

Art. 1135
bianco - *white*



Art. 1132
verde bosco - *forest green*

SPLENDIDA 5 POSIZIONI
poltrona 5 posizioni - chiudibile
5 position armchair - foldable



Art. 1990
bianco - *white*

QUEEN
sedia - chiudibile
chair - foldable



Art. 1218
bianco - *white*

Spiaggina **SPLENDIDA**
chiudibile - *folding beach chair*



Art. 2100
bianco - *white*



Art. 2101
giallo - *yellow*



Art. 2102
azzurro - *azure*

CONTENITORE MULTIUSO *cushion box*

MAXI BOX



Art. 2111
bianco - *white*



Art. 2110
verde / avorio
green / ivory



Art. 2114
grigio / antracite
grey / anthracite grey

MONOBLOCCO IMPILABILI *stackable monoblocs*

GINEVRA

poltrona impilabile in tecnopolimero rinforzato fibra di vetro - in air moulding
stacking armchair in fibreglass reinforced technopolymer - air moulding technology

CATAS Conforme EN 16139:2013
Compliant with EN 16139:2013



Art. 2333 11 lino - *linen* Art. 2333 15 tortora - *dove grey* Art. 2333 22 senape - *yellow mustard* Art. 2333 42 rosso geranio - *geranium red* Art. 2333 51 verde pistacchio - *light green* Art. 2333 62 azzurro - *light blue* Art. 2333 73 terracotta - *terracotta* Art. 2333 81 antracite - *anthracite grey*

SUNSET

poltrona impilabile in tecnopolimero rinforzato fibra di vetro - in air moulding
stacking armchair in fibreglass reinforced technopolymer - air moulding technology

CATAS Conforme EN 16139:2013
Compliant with EN 16139:2013



Art. 2329 11 lino - *linen* Art. 2329 15 tortora - *dove grey* Art. 2329 42 rosso geranio - *geranium red* Art. 2329 62 azzurro - *light blue* Art. 2329 86 grafite - *graphite* Art. 2329 81 antracite - *anthracite grey*

TOP

gambe tubolari - *tubular legs*

CALIFORNIA VIP

ANTIGRAFFIO *SCRATCHPROOF*

SUPER ELEGANT

ANTIGRAFFIO *SCRATCHPROOF*

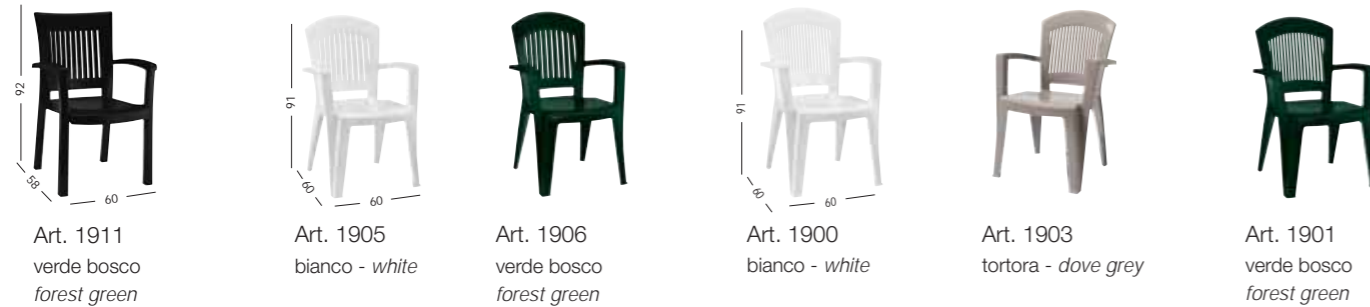

Art. 1911 verde bosco - *forest green* Art. 1905 bianco - *white* Art. 1906 verde bosco - *forest green* Art. 1900 bianco - *white* Art. 1903 tortora - *dove grey* Art. 1901 verde bosco - *forest green*

PENELOPE

schienale medio - *medium-sized back*

CALIFORNIA

schienale medio - *medium-sized back*

NUOVA CIRCE

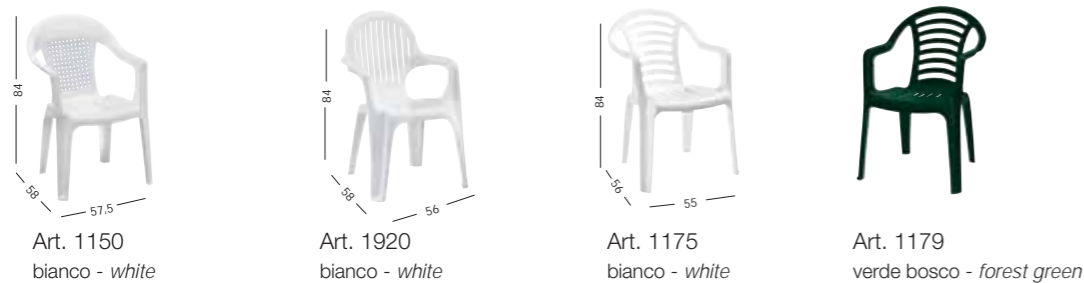

Art. 1150 bianco - *white* Art. 1920 bianco - *white* Art. 1175 bianco - *white* Art. 1179 verde bosco - *forest green*

CALIFORNIA ③

ANTIGRAFFIO - schienale alto - *SCRATCHPROOF - high-sized back*

ELEGANT ③

ANTIGRAFFIO - schienale alto - *SCRATCHPROOF - high-sized back*



Art. 1960 bianco - *white* Art. 1961 verde bosco - *forest green* Art. 1955 bianco - *white* Art. 1959 tortora - *dove grey* Art. 1956 verde bosco - *forest green*

GINEVRA

sedia impilabile in tecnopolimero rinforzato fibra di vetro - in air moulding
stacking chair in fibreglass reinforced technopolymer - air moulding technology

CATAS Conforme EN 16139:2013
Compliant with EN 16139:2013



Art. 2334 11 lino - *linen* Art. 2334 15 tortora - *dove grey* Art. 2334 22 senape - *yellow mustard* Art. 2334 42 rosso geranio - *geranium red* Art. 2334 51 verde pistacchio - *light green* Art. 2334 62 azzurro - *light blue* Art. 2334 73 terracotta - *terracotta* Art. 2334 81 antracite - *anthracite grey*

STELLA DI MARE®

schienale medio - *medium-sized back*

SEDIA STELLA DI MARE®

Chair



Art. 1190 bianco - *white* Art. 1193 verde bosco - *forest green* Art. 1185 bianco - *white* Art. 1186 tortora - *dove grey* Art. 1189 verde bosco - *forest green*

L 28

SUPER GIADA

GIADA



Art. 1112 bianco - *white* Art. 1108 verde bosco - *forest green* Art. 1235 bianco - *white* Art. 1236 verde bosco - *forest green* Art. 1111 bianco - *white* Art. 1114 verde bosco - *forest green*

TIJANA



Art. 1120 bianco - *white* Art. 1123 tortora - *dove grey* Art. 1121 verde bosco - *forest green* Art. 1122 nero - *black*

SEDUTE *linea intrecciati - woven patterned seats*

OLIMPO SOFA

Scocca intrecciata in tecnopolimero riciclabile rinforzato fibra di vetro.
Gambe in alluminio con cover intrecciata in tecnopolimero.
Impilabile.

*Woven patterned recyclable technopolymer main body reinforced with fibreglass.
Aluminium legs with woven pattern technopolymer cover.
Stackable.*

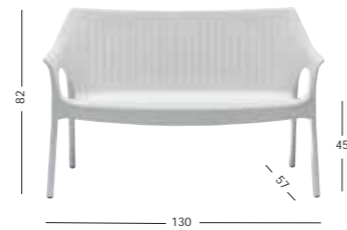

Cuscino per divano Olimpo Sofa
Cushion for Olimpo Sofa



Art. 1507 105
fantasia 105 cotone drill
pattern 105 cotton drill

imballo su pallet a 10 pz
packaging on pallet 10 pcs

Art. 1252-99 11
lino - linen

Art. 1252-99 15
tortora - dove grey

Art. 1252-99 70
bronzo - bronze

Art. 1252-99 81
antracite - anthracite grey

imballo in scatola da 2 pz con cuscini omaggio
packing in box 2 pcs with free cushions

Art. 1252 11
lino - linen

Art. 1252 15
tortora - dove grey

Art. 1252 70
bronzo - bronze

Art. 1252 81
antracite - anthracite grey

OLIMPIA TREND



Conforme EN 15373:2007
Compliant with EN 15373:2007



Art. 2279 11 SF
lino - linen



Art. 2279 15 SF
tortora - dove grey



Art. 2279 70 SF
bronzo - bronze



Art. 2279 81 SF
antracite - anthracite grey

OLIMPIA



Conforme EN 15373:2007
Compliant with EN 15373:2007



Art. 2277 AA 11 SF
lino - linen
gambe anodizzate
anodised legs



Art. 2277 AV 15 SF
tortora - dove grey
gambe verniciate in poliestere
polyester coated legs



Art. 2277 AV 70 SF
bronzo - bronze
gambe verniciate in poliestere
polyester coated legs



Art. 2277 AV 81 SF
antracite - anthracite grey
gambe verniciate in poliestere
polyester coated legs

MAXIMA



Conforme EN 15373:2007
Compliant with EN 15373:2007



Art. 2321 11
lino - linen



Art. 2321 70
bronzo - bronze



Art. 2321 81
antracite - anthracite grey

LUCREZIA POLTRONA



Art. 2322 11 SF
lino - linen



Art. 2322 15 SF
tortora - dove grey



Conforme EN 15373:2007
Compliant with EN 15373:2007

LUCREZIA



Conforme EN 15373:2007
Compliant with EN 15373:2007



Art. 2322 70 SF
bronzo - bronze



Art. 2322 81 SF
antracite - anthracite grey



Art. 2323 11 SF
lino - linen



Art. 2323 15 SF
tortora - dove grey



Art. 2323 70 SF
bronzo - bronze



Art. 2323 81 SF
antracite - anthracite grey

POLTRONA INTRECCIATA



Art. 1169 SF
lino - linen



Art. 1170 SF
tortora - dove grey



Art. 1171 SF
bronzo - bronze



Art. 1172 SF
antracite - anthracite grey

La ricerca SCAB non si ferma mai. Forte della sua esperienza, per chi ama lo stile classico e senza tempo, SCAB ha ampliato la sua offerta con la linea per giardino in alluminio e acciaio, che unisce robustezza ed elevata resistenza agli agenti atmosferici a uno stile sobrio e curato nei più piccoli dettagli. Forti nei materiali e gentili nelle forme, i prodotti della linea in alluminio e acciaio sono il modo più comodo per godersi la vita all'aria aperta.

Qualità SCAB

I mobili SCAB sono strutturati per durare nel tempo.

Vengono fabbricati nei nostri stabilimenti in Italia e sono soggetti a costanti collaudi ed a verifiche di idoneità qualitativa.

L'alluminio è un metallo che unisce leggerezza e grande robustezza.

La SCAB dedica la massima attenzione ai "Newton di resistenza meccanica" e all'alta qualità degli acciai impiegati nella costruzione del prodotto. Gli speciali trattamenti di zincatura e di verniciatura in poliesteri, conferiscono ai nostri prodotti una alta resistenza alla ruggine ed agli agenti esterni, a garanzia di una lunga durata in condizioni perfette.

Ogni modello originale SCAB è protetto da brevetti di forma e da diritti di esclusiva.

SCAB commitment to research never stops. Building on its experience, SCAB has now widened its range with a new line of aluminium and steel garden products, destined to those who prefer a timeless classic design. Here sturdiness and high resistance to weather conditions combine together with a simple design, in which attention to detail is of the utmost importance. Strong materials and gentle shapes make the aluminium and steel range the best way to enjoy life in the great outdoors.

SCAB Quality

SCAB products are built to last.

Produced in our Italian plants, they are constantly checked for suitability and quality.

Aluminium is a metal that combines lightness and great strength.

Only the highest quality steels are used and a strict control on mechanical resistance values is applied throughout the whole manufacturing process. The sophisticated galvanizing treatments and the painting process using polyester give our products a high level of protection against corrosion and weather conditions, ensuring that they remain rust free for years to come.

Each original SCAB model is protected by shape patents and exclusive rights.

IMBOTTITI, ALLUMINIO E ACCIAIO

PRODOTTI FABBRICATI IN ITALIA
PRODUCT MADE IN ITALY





Tettino / Canopy
COTONE / COTTON

MASTER PIÙ

4 posti / 4 seats

trasformabile a letto automaticamente - brevettato
cuscini imbottitura mm. 100
in lastra di resina espansa

*converts into a bed automatically - patented
slab padding cushions 100 mm.*

1410

struttura antracite
tettino e cuscini tessuto cotone drill
FANTASIA 85

*anthracite frame
cotton drill fabric canopy and cushions
PATTERN 85*

LORD

4 posti / 4 seats



cuscini imbottitura mm. 100
in lastra di resina espansa
con portabilite
slab padding cushions 100 mm.
with drink holder

1281

struttura verde
cuscini tessuto acrilico
FANTASIA 60
green frame
acrylic fabric cushion
PATTERN 60

MASTER PIU'

4 Posti
4 seats

trasformabile a letto
automaticamente - brevettato
cuscini imbottitura
mm.100
in lastra di resina espansa
converts into a bed
automatically - patented
slab padding cushions
100 mm.



Art.	1400	TELAIO frame	●
FANTASIA pattern	60 Acrilico / Acrylic		
TETTINO canopy	Acrilico / Acrylic		



Art.	1310	TELAIO frame	●
FANTASIA pattern	350 Cotone / Cotton		
TETTINO canopy	Acrilico / Acrylic		



Art.	1401	TELAIO frame	●
FANTASIA pattern	44 Cotone / Cotton		
TETTINO canopy	Cotone / Cotton		



Art.	1302	TELAIO frame	●
FANTASIA pattern	110 Cotone / Cotton		
TETTINO canopy	Cotone / Cotton		



Art.	1410	TELAIO frame	●
FANTASIA pattern	85 Cotone Drill / Cotton Drill		
TETTINO canopy	Cotone Drill / Cotton Drill		



Art.	1411	TELAIO frame	●
FANTASIA pattern	111 Cotone / Cotton		
TETTINO canopy	Cotone Drill / Cotton Drill		



Art.	1313	TELAIO frame	○
FANTASIA pattern	70 Acrilico / Acrylic		
TETTINO canopy	Acrilico / Acrylic		

DUCA

4 Posti
4 seats

cuscini imbottitura
mm.60
in lastra di resina
espansa
con portabilite
slab padding cushions
60 mm.
with drink holder



DUCA
Art. 1452 044
struttura verde
tettino e cuscini tessuto cotone
FANTASIA 44
green frame
cotton fabric canopy and cushions
PATTERN 44



Art.	1452 350	TELAIO frame	●
FANTASIA pattern	350 Cotone / Cotton		
TETTINO canopy	Cotone / Cotton		



Art.	1453 111	TELAIO frame	●
FANTASIA pattern	111 Cotone / Cotton		
TETTINO canopy	Cotone Drill / Cotton Drill		

LORD 4 Posti 4 seats

cuscini imbottitura
mm.100
in lastra di resina espansa
con portabibite

slab padding cushions
100 mm.
with drink holder



Tettino / Canopy
Acrilico / Acrylic

Art.	1281	TELAIO frame	
FANTASIA pattern	60 Acrilico / Acrylic		
TETTINO canopy	Acrilico / Acrylic		



Tettino / Canopy
Acrilico / Acrylic

Art.	1274	TELAIO frame	
FANTASIA pattern	350 Cotone / Cotton		
TETTINO canopy	Acrilico / Acrylic		



Tettino / Canopy
COTONE / COTTON

Art.	1275	TELAIO frame	
FANTASIA pattern	44 Cotone / Cotton		
TETTINO canopy	Cotone / Cotton		



Tettino / Canopy
COTONE / COTTON

Art.	1268	TELAIO frame	
FANTASIA pattern	110 Cotone / Cotton		
TETTINO canopy	Cotone / Cotton		



Tettino / Canopy
COTONE / COTTON

Art.	1343	TELAIO frame	
FANTASIA pattern	85 Cotone Drill / Cotton Drill		
TETTINO canopy	Cotone Drill / Cotton Drill		



Tettino / Canopy
Acrilico / Acrylic

Art.	1272	TELAIO frame	
FANTASIA pattern	70 Acrilico / Acrylic		
TETTINO canopy	Acrilico / Acrylic		

PRIMAVERA

cuscini confezionati
sottovuoto
flock padding cushions



Tettino / Canopy
COTONE / COTTON

Art.	1371	TELAIO frame	
FANTASIA pattern	44 Cotone / Cotton		
TETTINO canopy	Cotone / Cotton		



Tettino / Canopy
COTONE / COTTON

PRIMAVERA
Art. 1374
struttura verde
tettino e cuscini tessuto cotone
FANTASIA 350
green frame
cotton fabric canopy and cushions
PATTERN 350

FANTASIE patterns

ACRILICO Acrylic



fantasia 70 ACRILICO
pattern 70 Acrylic



fantasia 60 ACRILICO
pattern 60 Acrylic



Vantaggi che convincono:
solidi alla luce e resistenti alle intemperie - resistenti all'uso e indeformabili
permeabili all'aria - di facile manutenzione - resistenti alle muffe

Outstanding advantages:
lightfast and weatherproof - resistant to use and indeformable
air-permeable - easy upkeep - mildew resistant

COTONE Cotton



fantasia 350 COTONE
pattern 350 Cotton

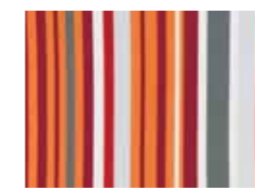

fantasia 111 COTONE
pattern 111 Cotton



colori freschi, luminosi, brillanti - bello, pratico ed elegante
- è naturale, è cotone

fresh, luminous and bright colours - nice, comfortable and elegant
- naturally, it is cotton



fantasia 44 COTONE
pattern 44 Cotton



fantasia 110 COTONE
pattern 110 Cotton

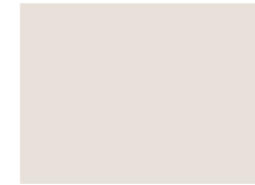

fantasia 85 COTONE DRILL
pattern 85 Cotton Drill



fantasia 105 COTONE DRILL
pattern 105 Cotton Drill

MISURE dimensions

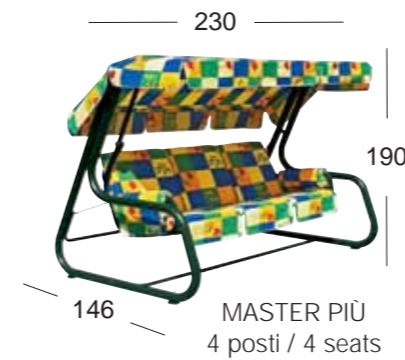

LULA
POLTRONA



LULA
2090

PIEGHEVOLE
TAVOLO

2736
PIEGHEVOLE
tavolo 80x80x h.75 cm.
acciaio zincato
e verniciato in poliestere
antracite
table 80x80x h.75 cm.
anodised and polyester
coated steel
anthracite grey



PIEGHEVOLE 80x80
tavolo chiudibile / folding table



Art. 2736
antracite
anthracite grey

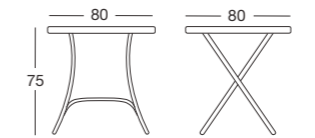

RAFFAELLO
tavolo / table



Art. 2729
lino
linen

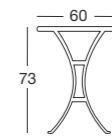

Art. 2726
antracite
anthracite grey

LULA
poltrona impilabile
struttura alluminio
verniciato in poliestere
sedile e schienale
tecnopolimero riciclabile
stackable armchair
polyester coated
aluminium frame
recyclable technopolymer
seat and backrest

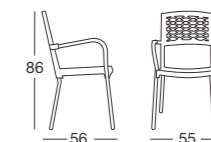

Art. 2090
antracite
anthracite grey



Sede/Headquarters:
25030 Coccaglio (BS) Italia
Via G.Monauni, 12
Tel. +39 030 7718.611

Divisione Commerciale Italia:
Tel. +39 030 7718.760/765/770/775
Fax +39 030 7718.777
www.scab.it
e-mail: italia@scab.it

Export Department:
Phone +39 030 7718.720/725/726
Fax +39 030 7718.700
www.scabitaly.com
e-mail: export@scabitaly.com

SCAB si riserva il diritto di modificare, senza preavviso, la propria produzione. Misure e colori sono puramente indicativi. Per ragioni tecniche di stampa i colori/tessuti stampati possono differire lievemente da quelli reali.
SCAB reserves the right to make alterations to its product range without giving prior notice. Measurements and colours shown are approximatives. The printed colours/fabrics may differ slightly from the actual ones for photo and print technical reasons.

È tassativamente vietato riprodurre senza autorizzazione il materiale fotografico contenuto nel presente catalogo. Ogni modello originale SCAB è protetto da brevetti di forma e da diritti di esclusiva.
The reproduction of the photographic material contained in the present catalogue is strictly forbidden. All original SCAB models are covered by shape patents and exclusive rights.

