

Modelli/Models: Kubix/Kontat/Korium/Konvert/Kosmo

Syncon



Modelli/Models: Kubix/Kontat/Korium/Konvert/Kosmo

Syncon + Traslatore + Varia (Variatore angolo sedile-schienale)

Syncon + Slide System + Varia (Seat-back angle adjustment)

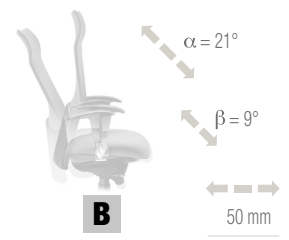
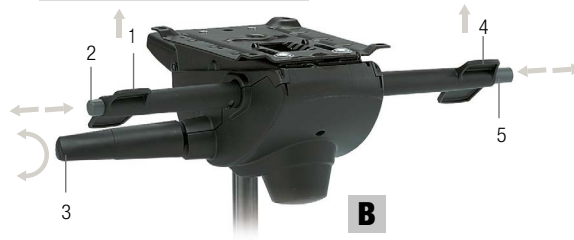

Modelli/Models: /Konica/Kriteria (lockable in 4 positions)

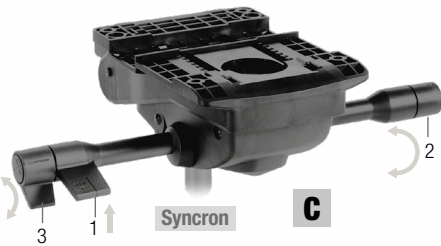

Modelli/Models: Konica

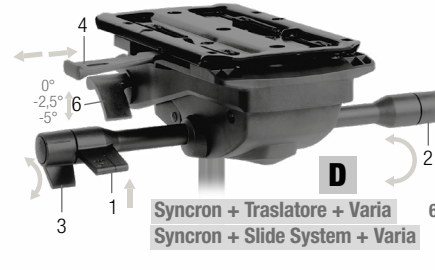

3-Regolazione rapida di intensità di carica in 10 diverse posizioni con 1/4 di giro della leva (con schienale non caricato)
Fast tension adjustment in 10 different positions by 1/4 of lever turn (do not lean on the back)

6-Variatore angolo sedile
Seat angle adjustment (inclinazione negativa/Negative inclination 0°/-2,5°/-5°)

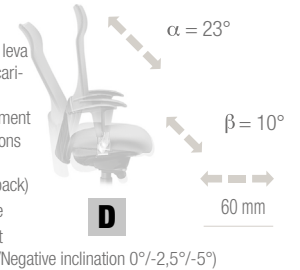

Modelli/Models: Kamelia

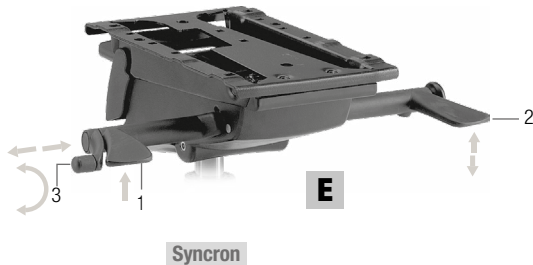

Modelli/Models: Karma (Syncon H-Syncon Varia HV)

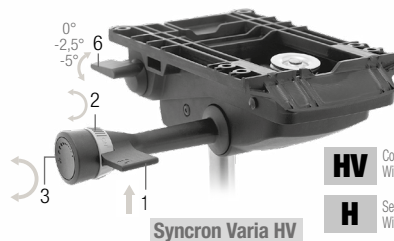

HV Con variatore angolo sedile
With seat angle adjustment
H Senza variatore angolo sedile
Without seat angle adjustment

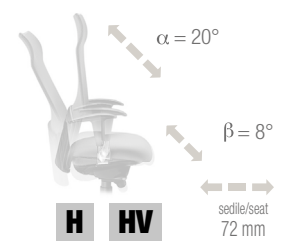

Modelli/Models: Kuper (easy mesh) - Kubika - Karma

Modelli/Models: Kuper (easy mesh) - Kubika

Modelli/Models: Konfort/Kubix

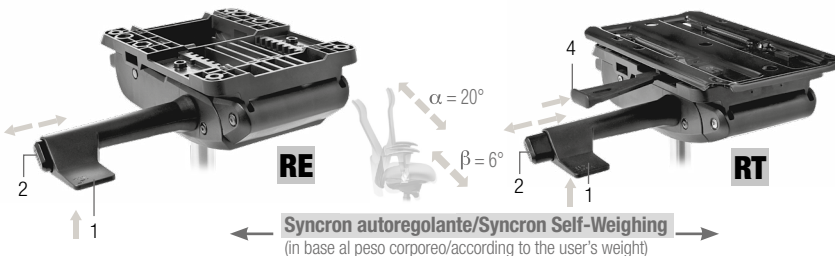

Syncon autoregolante/Syncon Self-Weighing
(in base al peso corporeo/according to the user's weight)



Modelli/Models: Kruna/Kimera/King/Klassic

Modelli/Models: Kimera/King/Klassic/Kriteria

Modelli/Models: Kruna



Oscillante-Tilt



Oscillante-"Knee tilt"
(Con punto di rotazione avanzato
With advanced point tilting)



Oscillante-"Knee tilt"
(Con punto di rotazione avanzato
With advanced point tilting)

- 1 - Leva di alzo seduta
- Seat height adjustment
- Réglage hauteur assise
- Sitzhöhenverstellung
- palanca de regulación altura asiento
- 2 - Blocco e sblocco oscillazione
- Tilt movement control
- Blocage et deblocage de la bascule
- Für die Regulierung der Neigungsbewegung
- Para bloqueo y liberación basculante

- 3 - Regolatore intensità di carica
- Tension adjustment
- Réglage tension
- Einstellmöglichkeit der Federkraft
- regulador tensión
- 4 - Leva regolazione profondità seduta
- Seat depth adjustment
- Réglage en profondeur de l'assise
- Hebel für die Sitztiefenverstellung
- palanca de regulación profundidad asiento

- 5 - **Varia**
- Variatore d'assetto, funzione che limita l'escursione in avanti dello schienale
- Attitude variator, limiting the movement of the backrest forward
- Variateur d'assiette pour limitation de course en avant du dossier
- Lageregler: Vorrichtung zur Begrenzung des Vorschubs der Rückenlehne nach vorne
- Control movimiento del respaldo.
- 6 - **Varia**
- Con variatore angolo sedile (inclinazione negativa 0°/-2,5°/-5°)
- With seat angle adjustment (negative inclination 0°/-2,5°/-5°)
- Avec variateur d'assiette (inclinaison négative 0°/-2,5°/5°)
- Mit Einstellmöglichkeit des Lagereglers (negative Sitzneigung 0°/-2,5°/5°)
- Con variador ángulo de asiento (inclinación negativa 0°/-2,5°/5°)

Tutti i meccanismi sono dotati di blocco automatico (varie posizioni) e sistema antishock
All mechanisms stop automatically (different positions) and have antishock system.

MÉCANISMES MECHANISMEN

Modèles/Modelle: Kubix/Kontat/Korium/Konvert/Kosmo

Modèles/Modelle: Kubix/Kontat/Korium/Konvert/Kosmo
Synchron+Réglage profondeur assise +Varia (Angle d'assise variable)
Synchron + Sitztiefeverstellung + Varia

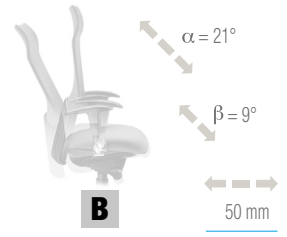
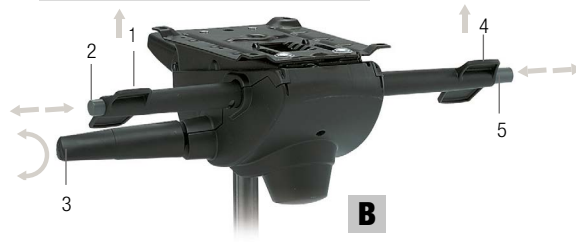

Modèles/Modelle: /Konica/Kriteria (lockable in 4 positions)

Modèles/Modelle: Konica

3-Réglage rapide de la tension en 10 positions. Schnelle Einstellung der Federkraft der Neigungsbewegung in 10 Stellungen.

6-Variateur d'assise assise (inclinaison négative 0°/-2,5°/-5°) Sitzneigungsverstellung (Negative Sitzneigung 0°/-2,5°/-5°)

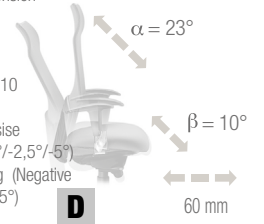
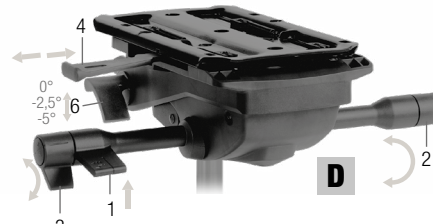
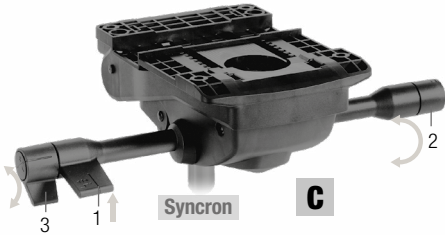

Synchron + Réglage en profondeur assise + Varia (Angle assise-dossier variable)
Synchron + Sitztiefeverstellung + Varia (Neigungsverstellung des Sitzes und der Rückenlehne)

Modèles/Modelle: Kamelia

Modèles/Modelle: Karma (Synchron H-Synchron Varia HV)

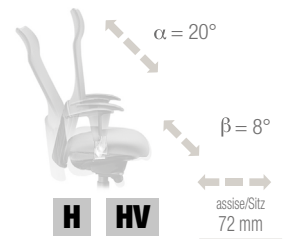
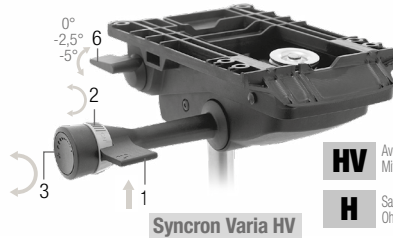
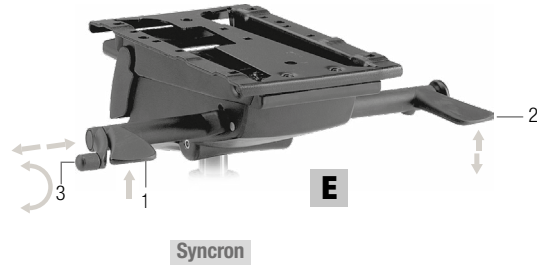

HV Avec variateur d'assise assise Mit Einstellmöglichkeit des Lagereglers

H Sans variateur d'assise assise Ohne Einstellmöglichkeit des Lagereglers

Modèles/Modelle: Kuper (easy mesh) - Kubika - Karma

Modèles/Modelle: Kuper (easy mesh) - Kubika

Modèles/Modelle: Konfort/Kubix

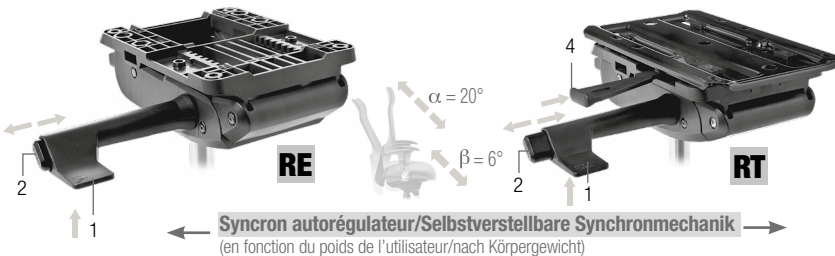

Modèles/Modelle: Kruna/Kimera /King/Klassic

Modèles/Modelle: Kimera/King/ Klassic/Kriteria

Modèles/Modelle: Kruna

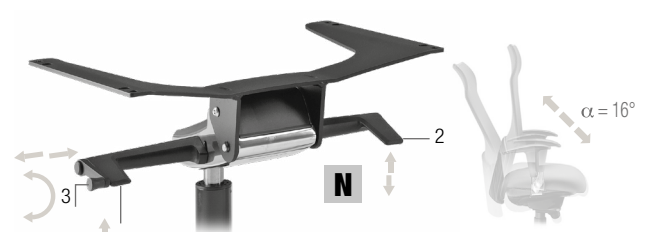
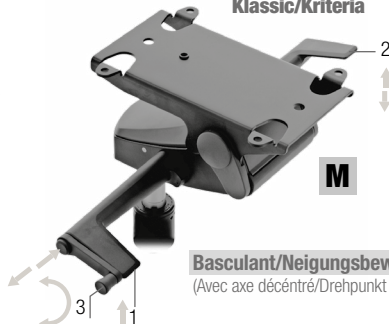

Basculant/Wippmechanik «Tilt»

Basculant/Neigungsbewegung «Knee-tilt»
(Avec axe décentré/Drehpunkt nach vorne)

Basculant/Neigungsbewegung «Knee-tilt»
(Avec axe décentré/Drehpunkt nach vorne)

1 - Réglage hauteur assise

- Sitzhöhenverstellung
- Leva di alzo seduta
- Seat height adjustment
- Palanca de regulación altura asiento

2 - Blocage et déblocage de la bascule

- Für die Regulierung der Neigungsbewegung
- Blocco e sblocco oscillazione
- Tilt movement control
- Para bloqueo y liberación basculante

3 - Réglage tension

- Einstellmöglichkeit der Federkraft
- Regolatore intensità di carica
- Regulador tensión
- Tension adjustment

4 - Réglage en profondeur de l'assise

- Hebel für die Sitztiefeverstellung
- Leva regolazione profondità seduta
- Seat depth adjustment
- Palanca de regulación profundidad asiento

5 - Varia

- Variateur d'assise pour limitation de course en avant du dossier
- Lageregler: Vorrichtung zur Begrenzung des Vorschubs der Rückenlehne nach vorne
- Variatore d'assetto, funzione che limita l'escursione in avanti dello schienale
- Attitude variator, limiting the movement of the backrest forward
- Control movimiento del respaldo

6 - Varia

- Avec variateur d'assise assise (inclinaison négative 0°/-2,5°/5°)
- Mit Einstellmöglichkeit des Lagereglers (negative Sitzneigung 0°/-2,5°/5°)
- Con variatore angolo sedile (inclinaison negativa 0°/-2,5°/5°)
- With seat angle adjustment (negative inclination 0°/-2,5°/5°)
- Con variador ángulo de asiento (inclinaison negativa 0°/-2,5°/5°)

Tous les mécanismes sont équipés d'un système de blocage automatique (différentes positions) et système antichoc - Alle Mechanismen sind mit automatischer Einstellung in verschiedenen Stellen und Anti-Schock-System ausgestattet.