

# Platinum parasols

Functionality, design, ease of use and robustness

# About us



# Why platinum parasols

## **Specialist** in Dutch design parasols

- In house development of unique models
- A wide and deep assortment
- Full product knowledge

## **Branded** and **Private label**

**Mixed container** shipments from China at minimal MOQ's

**Complete assortment** and spare parts on stock in the Netherlands and China

**Strong availability** of granite parasol bases



# Design and development

## Dutch design

- Ease of use
- Functionality

## Primair is:

- Optimal protection against the sun
- Be able to be positioned towards the sun in the best possible way

## Design and the innovative double tilt mechanism resulted in T2 versions:

- Rotate, tilt and twist

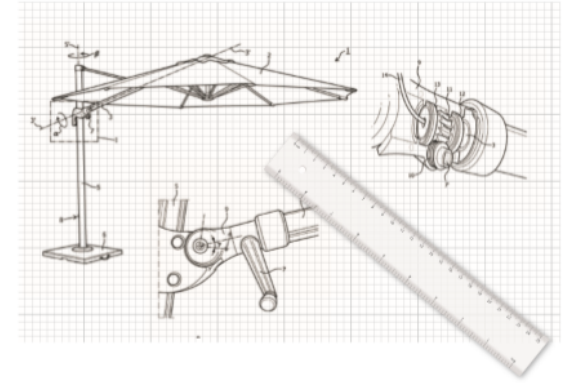

# Craftmanship and quality

**Wide range of fabrics and coatings**  
following international trends and standards

Attention to **detail** and **durability**

**Latest** production methods

**Rigorous** testing

**Quality materials** for difficult weather conditions



# Flexible logistics

## **We keep stock**

in the Netherlands and in China

## **FOB China**

deliveries

## **Mixed container**

deliveries at minimal MOQ's

## **Parcel deliveries**

from the Netherlands at low minimal order values

## **Short**

lead-times

# After sales

## Detailed service book

for support during and after warranty period.

## Spare parts

on stock in the Netherlands and China

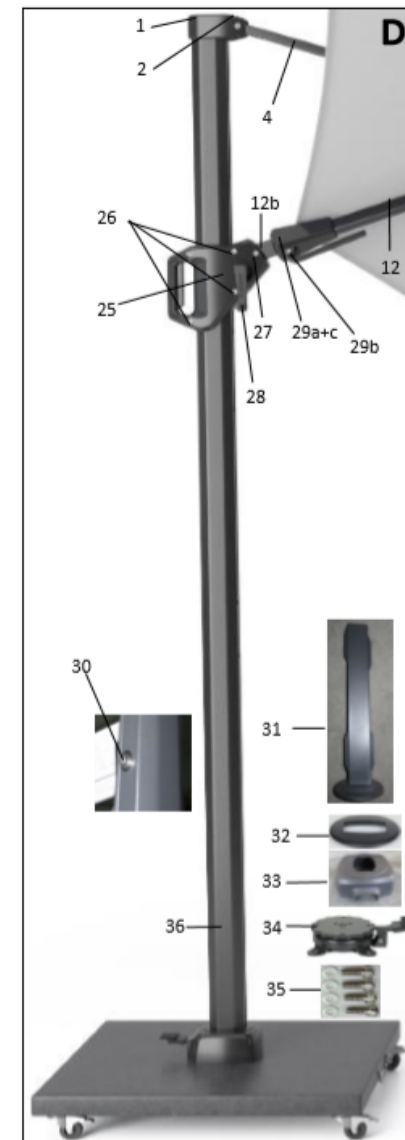

# On- and Offline support

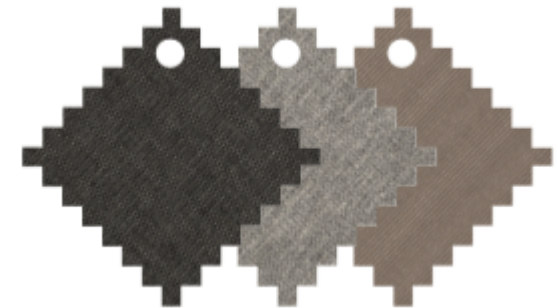



Platinum<sup>®</sup>  
casual living

# Free arm parasols



# Icon



Single tilt



360  
degrees  
turning

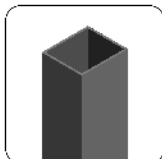

Pole 78x78



Cast  
aluminium  
handle



Material  
class

## Premium model

- Extreme ease of use
- Unprecedented robustness
- For large outdoor areas
- Windstabilizer, robust ribs and 78x78 pole ensures stability in windy conditions
- Weatherproof aluminium
- Spuncrylic fabric for canopy
- Frame in Anthracite, Silver and Oak



AeroCover  
7978



In-ground  
parasol  
base XL



Granite  
base 150kg



LED 7895

# Challenger T2

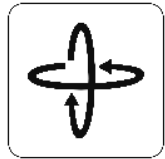

Double tilt



360 degrees turning

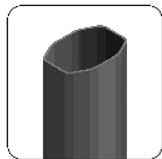

Pole 86x53



Cast alu handle

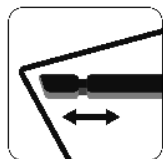

Tension springs



Material class



AeroCover 7970



In-ground parasol base XL



Granite base minimum 90 kg



Cross base



LED 7895

## The flagship of our collection

- Double tilt; can rotate, tilt and twist
- Deluxe design without compromise, engineered with comfort in mind
- Cast aluminium handle, aluminium frame with stainless steel interior
- Frame in Anthracite, white and Oak
- Canopy available in spuncrylic and 300 gr polyester

# Challenger T2 Glow

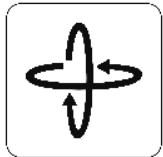

Double tilt



360 degrees turning

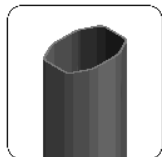

Pole 86x53



Cast alu handle

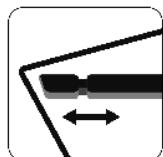

Tension springs



Integrated LED light



AeroCover 7970



In-ground parasol base XL



Granite base minimum 90 kg



Cross base



Material class

- Wireless led light integrated in the ribs; can shine upwards and downwards
- Double tilt; can rotate, tilt and twist
- Deluxe design without compromise, engineered with comfort in mind
- Cast aluminium handle, aluminium frame with stainless steel interior
- Frame in Anthracite
- Canopy available in 300 gr polyester

# Challenger T1



- Single tilt; can rotate and tilt backwards
- Deluxe design without compromise, engineered with comfort in mind
- Cast aluminium handle, aluminium frame with stainless steel interior
- 400x300cm canopy size for larger outdoor areas
- Frame in Anthracite
- Canopy available in spuncrylic and 300 gr polyester



Single tilt



360 degrees  
turning

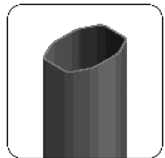

Pole 86x53



Cast alu  
handle

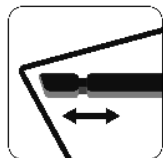

Tension  
springs



Material  
class



AeroCover  
7970

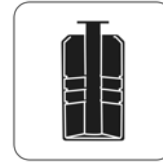

In-ground  
parasol  
base XL



Granite base  
90 kg  
400x300  
120 kg



Cross base

# Challenger T1 Telescope



Single tilt



360 degrees turning

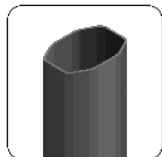

Pole 86x53



Cast alu handle

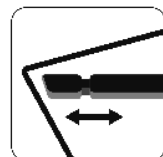

Tension springs



Telescope function



AeroCover 7970



In-ground parasol base XL



Granite base  
90 kg  
400x300  
120 kg



Cross base



Material class

- Opens en closes above your set with ease as the pole moves up by itself with a push on a button
- Single tilt; can rotate and tilt backwards
- Deluxe design without compromise, engineered with comfort in mind
- Cast aluminium handle, aluminium frame with stainless steel interior
- Frame in Anthracite
- Canopy available in spuncrylic

# Challenger T1 Telescope movie



# Fabrics and colors canopy

- Material class 1 100% polyester - 220 grams/m<sup>2</sup>  
Colourfastness 5 - UPF 35+
- Material class 2 100% polyester - 220 grams/m<sup>2</sup>  
Colour fastness 5-6 - UPF 35+, PA coated
- Material class 3 100% polyester - 300 grams/m<sup>2</sup>  
Colourfastness 5-6 - UPF 35+, PU coated
- Material class 4 Premium 100% spuncrylic - 240 grams/m<sup>2</sup>  
Solution dyed - Colourfastness 7, UPF 50+  
Optimal protection against UV rays

All fabrics are water-repellent and dirt resistant.

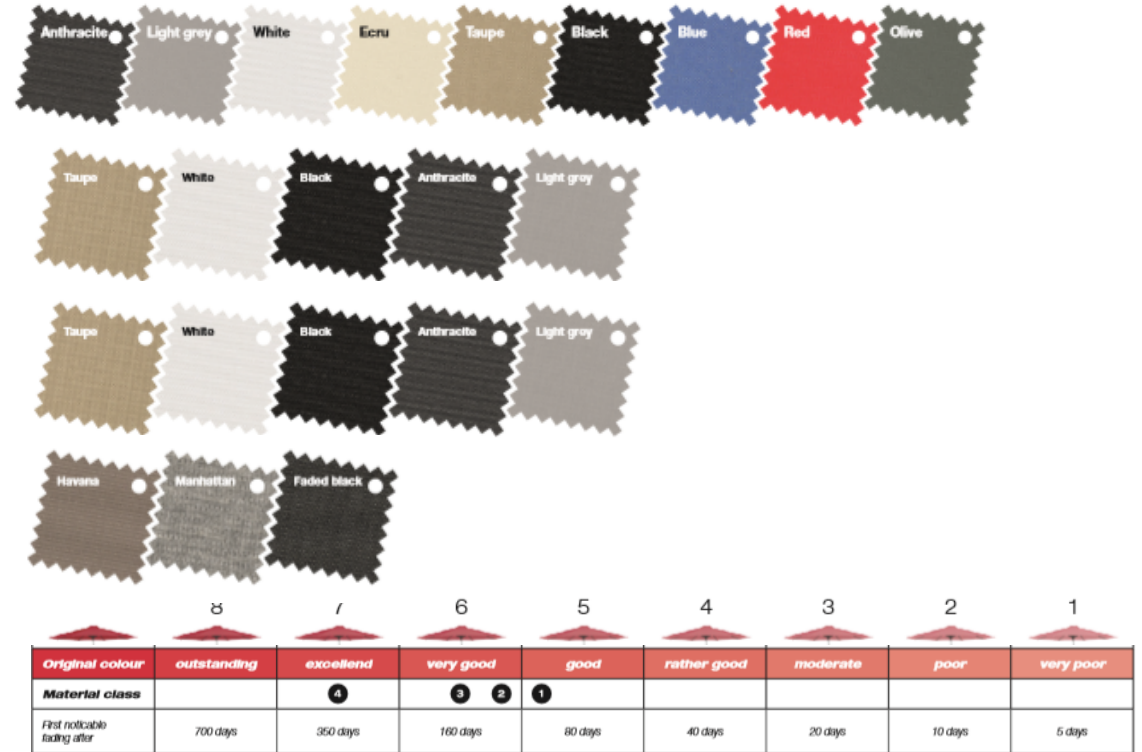



# Frame colors



Anthracite



Silver



White

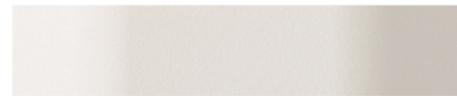

Oak



# Parasol bases

## Center pole parasol bases

- Stainless steel tubes
- Granite; black polished
- Adapter system for max tube diameter of 48mm
- Anti-slip system ensures that parasol can't spin in the wind

## Free-arm parasol bases

- Stainless steel tubes
- Granite; polished or burned
- Optional swivel wheels
- Variations in weight

## In ground parasol bases

- No parasol base in sight when parasol is not in use

