

**Gaber®**

**Workspace Systems  
and Tables**

**Gaber®**

GABER® Indoor & Outdoor Quality Design, Made in Italy

Acoustic • Outdoor • Office • Hospitality

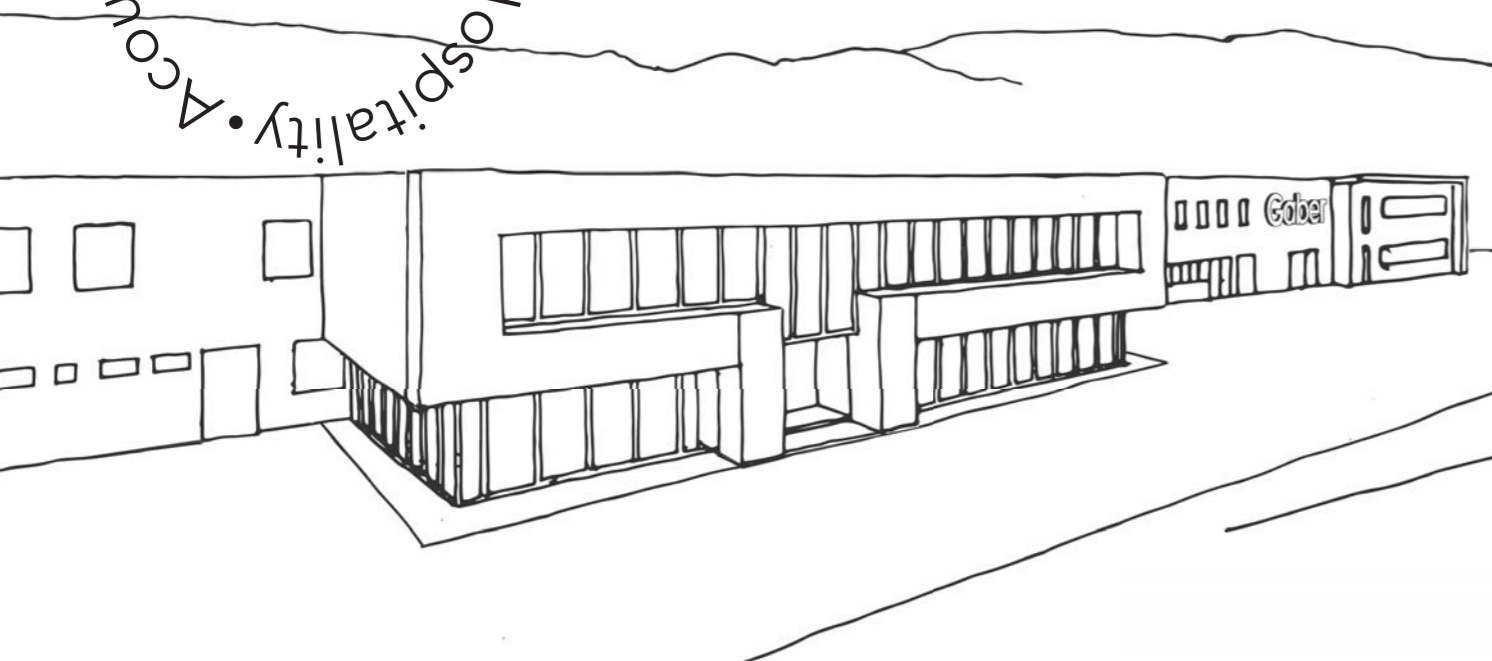

# Made in Italy

Contract Furniture

Gaber designs, develops and produces furniture for the contract world, responding to the needs of design, flexibility and quality thanks to the high level of expertise achieved in the molding of plastics and metal processing. Production efficiency, continuous research and great attention to details make it possible to create practical, versatile and long-lasting furnishing solutions.

The total customization at the service of the world of architecture and design make us the ideal partner to style and furnish different environments, all dedicated to hospitality and therefore to the well-being of people sharing moments of work, meeting and relaxation. Projects in which each product has its strong, distinctive features and is part of a furnishing system designed to interpret evolving needs, new times and new meeting places.

Gaber progetta, sviluppa e produce arredi per il mondo contract rispondendo a esigenze di design, flessibilità e qualità grazie all'altissima expertise raggiunta nello stampaggio di materie plastiche e nella lavorazione del metallo. Efficienza produttiva, ricerca continua e grande attenzione ai dettagli permettono di realizzare soluzioni di arredo pratiche, versatili e durature.

La totale customizzazione al servizio del mondo dell'architettura e del design ci rendono il partner ideale per arredare diversi ambienti, tutti orientati all'hospitality e quindi al benessere di persone che condividono momenti di lavoro, di incontro e di relax. Progetti in cui ogni prodotto ha un forte carattere distintivo e si inserisce in un sistema di arredo studiato per interpretare esigenze in divenire, nuovi tempi e nuovi luoghi di incontro.

As pure expression of Made in Italy, Gaber interprets that balance between craftsmanship and industry by creating furnishings able of satisfying the tastes and needs of its international audience, with a high level of customization and a wide range of finishes.

Pura espressione del Made in Italy, Gaber interpreta quell'equilibrio tra artigianato e industria che si realizza in arredi capaci di soddisfare gusti ed esigenze di un pubblico internazionale, con un alto livello di personalizzazione e ampia gamma di finiture.





# COVERINGS & finishes

Coverings and finishes stimulate and impact on the senses: they are decorations, textures and patterns. Research, technology and developments assist Gaber® in the production of new emotional tactile feelings on surfaces made for Interior Design. This is the place where your products are born.

















Rivestimenti e finiture superficiali suscitano emozioni e sollecitano i sensi: che si tratti di decori, texture o trame. Ricerca, sperimentazione e tecnologia aiutano Gaber® nella produzione di nuovi effetti tattili ed emozionali per le superfici destinate all'Interior Design. Questo è il posto dove nascono i vostri prodotti.



#keepdreaming on gaber.it

## CONTENTS / INDICE TABLES

### COFFEE TABLES\_H35/50

TAG Ilaria Marelli Design	P.89 <b>[NEW]</b> SURFY Studio Eurolinea Design	P.45 SURFY Studio Eurolinea Design	P.45
			
STEFANINO Studio Eurolinea Design	P.81 STEFANO 3-POD Studio Eurolinea Design	P.79 WOODY Favaretto & Partners Design	P.83 SATURNINO Studio Eurolinea Design
			
P.87 ROLLER Studio Eurolinea Design	P.129	P.93 SIMPLY Studio Eurolinea Design	P.121 MINUSH Studio Eurolinea Design
			
ARKET Studio Eurolinea Design	P.47 LOL3 Forsix Design	P.51 LINK Stefano Sandonà Design	P.95
			
CLARO Studio Eurolinea Design	P.101 CLARO SLIM Studio Eurolinea Design	P.105	
			



## HIGH TABLES\_H100/110

SURFY HIGH DESK 2027 P.44 STEP P.115 FORMAT P.119 BANKET P.113 ICS P.117  
 Studio Eurolinea Design Studio Eurolinea Design Studio Eurolinea Design Studio Eurolinea Design Studio Eurolinea Design



AZIONE P.61 CLARO SLIM P.107 SIMPLY P.121 TOGETHER P.73 NORMAN P.34  
 Forsix Design Studio Eurolinea Design Studio Eurolinea Design Marc Sadler Design Forsix Design [NEW]



GLITTER P.57 ARKET P.47 LEI P.213 TKITT P.135 TATAMI P.229  
 Forsix Design [NEW] Studio Eurolinea Design Studio Eurolinea Design Studio Eurolinea Design Studio Eurolinea Design



SERIE R P.217 - 218 SERIE Q P.221 - 223 ROLLER P.132  
 Studio Eurolinea Design Studio Eurolinea Design Studio Eurolinea Design



## TABLES\_H74

APRIO P.97 CLARO P.101 CLARO SLIM P.106  
 Forsix Design [NEW] Studio Eurolinea Design Studio Eurolinea Design



SIMPLY P.121 ROLLER P.131 MUG P.127 SATURNO P.85 TKITT P.135  
 Studio Eurolinea Design Studio Eurolinea Design Studio Eurolinea Design Studio Eurolinea Design Studio Eurolinea Design



GLITTER P.57 ARKET P.48 ARKET PLUS P.49  
 Forsix Design [NEW] Studio Eurolinea Design Studio Eurolinea Design



BRISTOL P.59 LOL P.51 LOL PLUS P.55  
 Forsix Design [NEW] Forsix Design Forsix Design



LEI P.213 HUG P.123 AMICA P.215 NORMAN P.34 LOGIN P.65  
 Studio Eurolinea Design Studio Eurolinea Design Studio Eurolinea Design Forsix Design [NEW] Studio Eurolinea Design



TABLES

TABLES\_H74

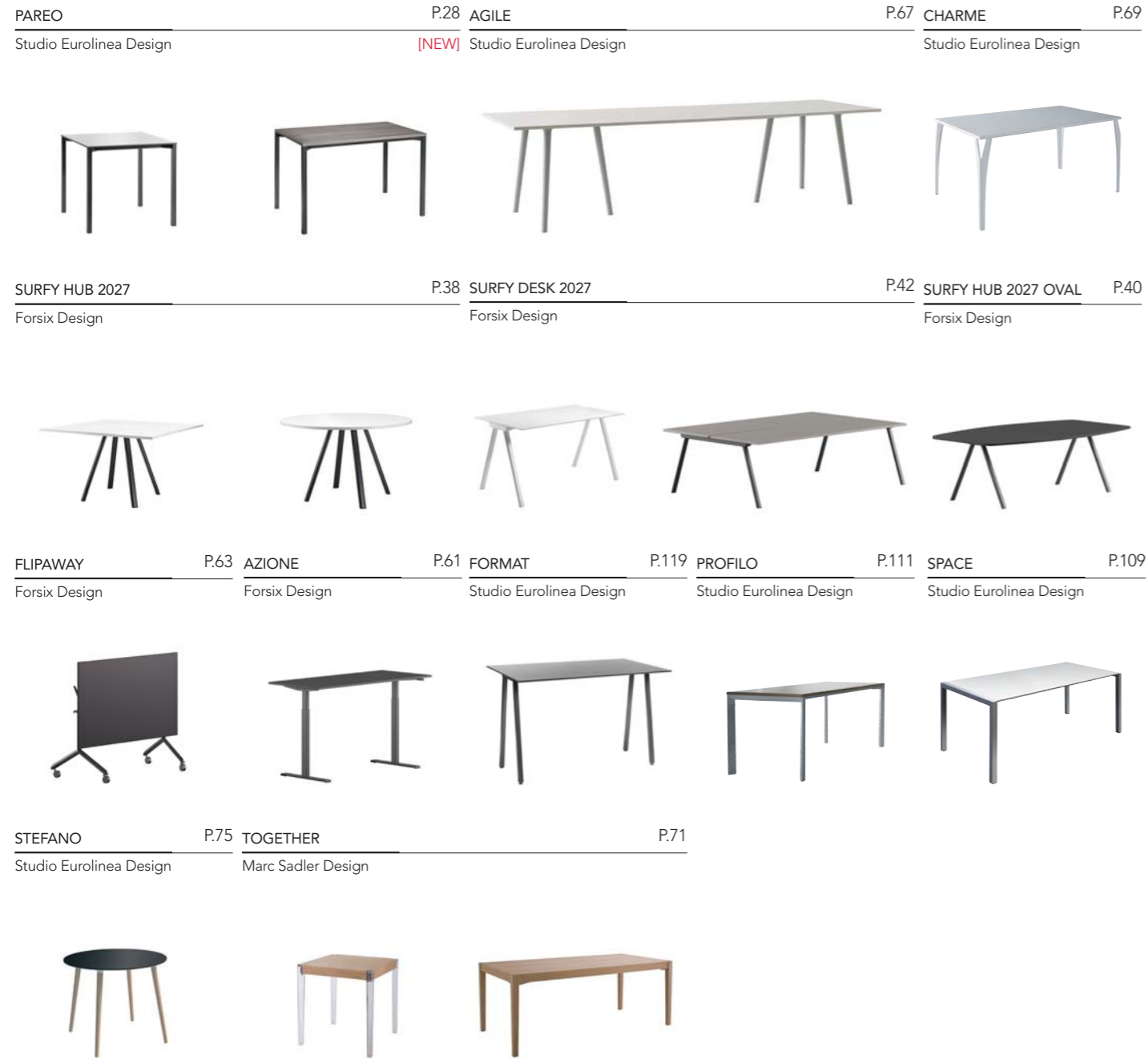

TABLES

TKITT COLLECTION

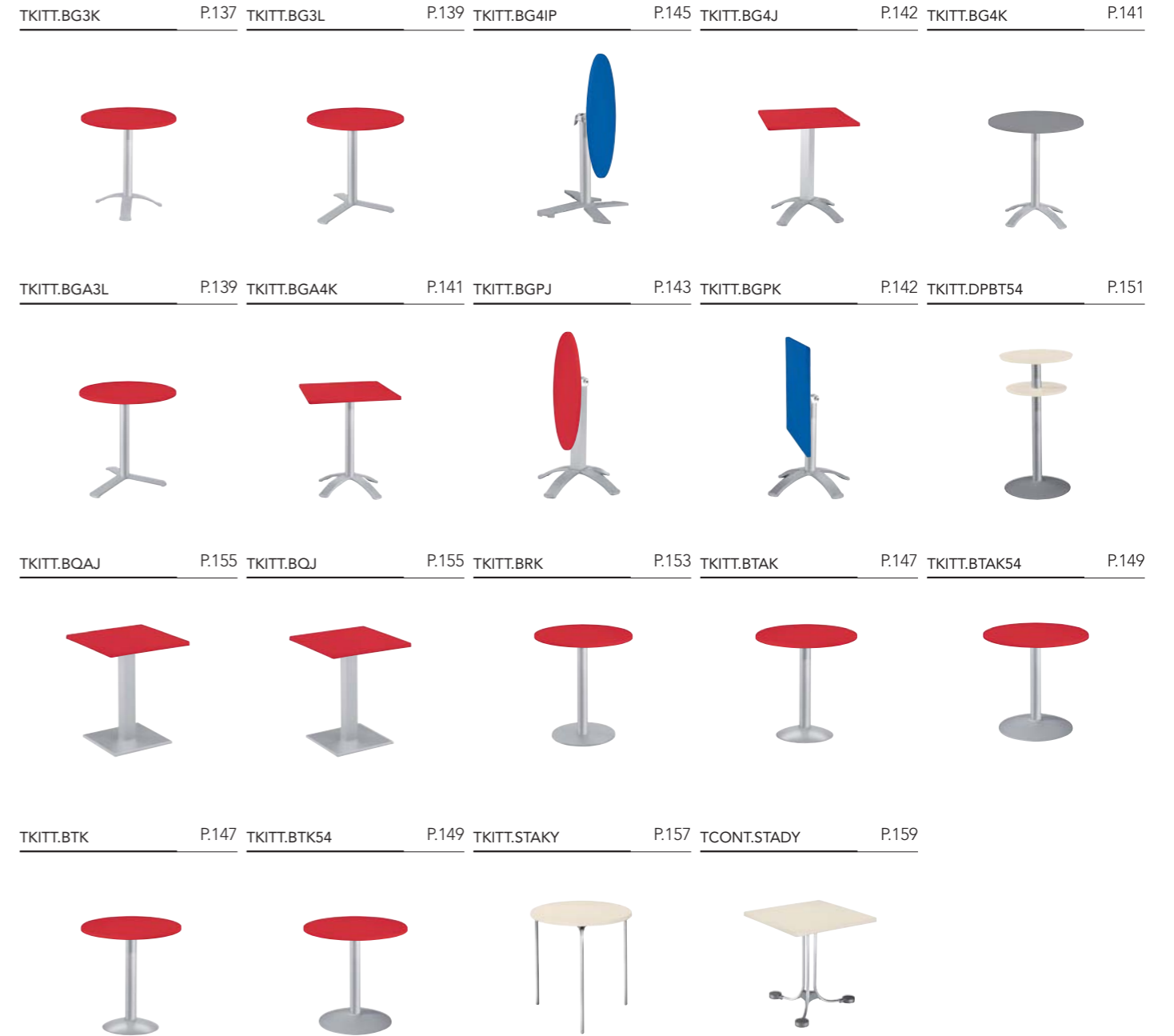



TABLE TOPS

STANDARD COMPACTOP SURFACES P.162 SPECIAL COMPACTOP SURFACES FULLCOLOR P.163 SPECIAL COMPACTOP SURFACES 10 P.164 SPECIAL COMPACTOP SURFACES FENIX P.166 STANDARD LAMINATED SURFACES 22 P.167



STANDARD LAMINATED SURFACES 50 P.168 SPECIAL LAMINATED SURFACES WOOD EFFECT 25 P.169 SPECIAL LAMINATED SURFACES FENIX 25 P.170 IRON SURFACES P.171 TECHNO POLYMER TABLE TOPS P.172



TABLE BASES COLLECTION

ALFIE P.227 AMICA P.215 ARKET PLUS P.175 ARKET 3 P.174



ARKET 4 P.175 BG2J P.191 BG3K - BGA3K P.177 BG3L - BGA3L P.181



BG4IP P.189 BG4J P.183 BG4K - BGA4K P.183 - 185 BGPJ P.184 BGPK P.184



BPG3K P.179 BPG4K P.187 BQAJ - BQJ P.205 BRCV P.197 BRISTOL P.210 [NEW]



BRK P.203 BTAK - BTK P.193 BTAK54 - BTK54 P.195 D2 P.225 GLITTER P.211 [NEW]



TABLES

TABLE BASES COLLECTION

LEI P.213 LOL PLUS P.209 LOL 3 P.207 LOL 4 P.208

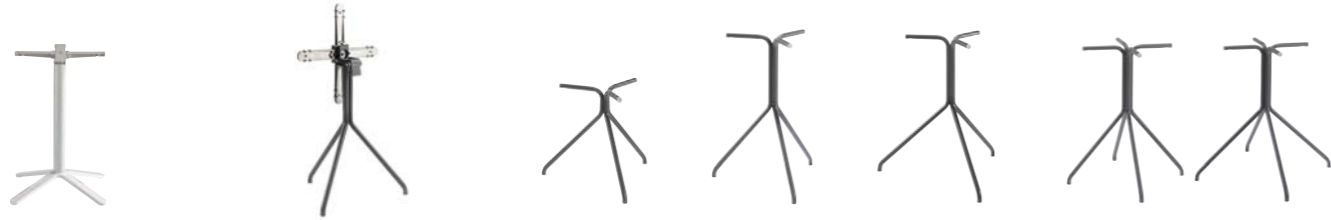

Q1 - Q2 - Q3 P.221 - 223 R1 - R2 - R3 P.217 - 218



T1 FLOOR FIXING P.219 TATAMI P.229 V1 P.218 VENUS ROUND P.199 VENUS SQUARE P.201



CABINETS & WORKSTATION

OFFICE & WORKSPACES SYSTEMS

WORKSTATIONS 2027 Forsix Design P.232 [NEW]



CABINETS 2027 Forsix Design P.242 [NEW]



ACCESSORIES

FLAIRE P.252 LUX P.253 CULTURE P.251 DISPLAY P.249  
 Studio Eurolinea Design Studio Eurolinea Design Malene Fløsted Urup Design [NEW] Malene Fløsted Urup Design [NEW]



COLORS AND FINISHES

COLORS AND FINISHES P.254





# AWARDS

SUCCESS IN PROGRESS



Gaber has won prestigious awards in the field on innovation and design. These recognitions are a testament to Gaber's unstinting commitment to design and the focus on originality and innovation we bring to the world.

Gaber ha vinto prestigiosi riconoscimenti nel campo dell'innovazione e del design. Questi riconoscimenti sono una testimonianza dell'impegno incondizionato di Gaber per il design e l'attenzione all'originalità e all'innovazione che portiamo al mondo.

**ALHAMBRA**  
2010  
Stefano Sandonà Design



**FREEDOM**  
2010  
Stefano Sandonà Design

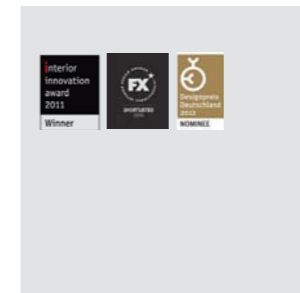

**BIG BANG**  
2011  
Stefano Sandonà Sabrina Bettini Design



**MOEMA wood**  
2011  
Stefano Sandonà Design

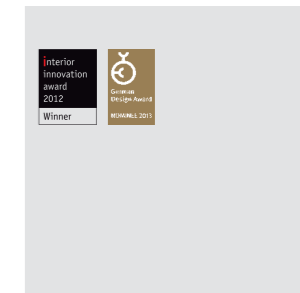

**MAGIC**  
2003  
Studio Eurolinea Design



**OVER**  
2004  
Studio Eurolinea Design



**PRISMA**  
2005  
Studio Eurolinea Design



**PRODIGE**  
2007  
Delineo Design

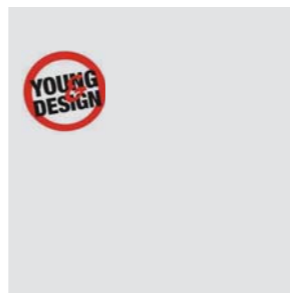

**JOE**  
2011  
Stefano Sandonà Design



**COLORFIVE**  
2011  
Stefano Sandonà Design



**TOGETHER**  
2011  
Marc Sadler Design



**BLOG**  
2012  
Stefano Sandonà Design



**FLOWER**  
2008  
Laura Tombari Design

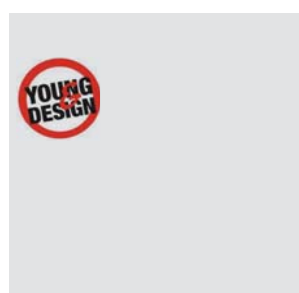

**SPRING**  
2008  
Monica Graffeo Design



**EXTREME**  
2009  
Stefano Sandonà Design



**MOEMA**  
2009  
Stefano Sandonà Design



**OCTO**  
2012  
Stefano Sandonà Design



**MORE**  
2012  
Favaretto & Partners Design

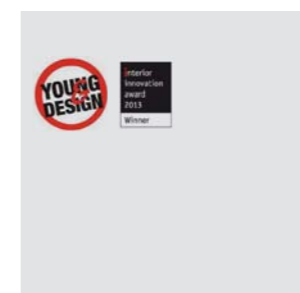

**PANAMA**  
2013  
Stefano Sandonà Design



**AKAMI**  
2013  
Stefano Sandonà Design



AWARDS

SUCCESS IN PROGRESS



**SLOT**  
2013  
Favaretto & Partners Design



**CHEVALET**  
2013  
Favaretto & Partners Design



**BASKET**  
2013  
Alessandro Busana Design

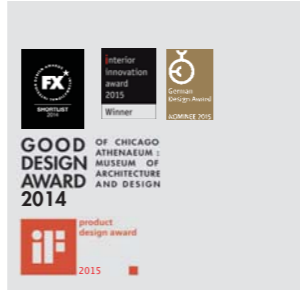

**EPICA**  
2014  
Marc Sadler Design



**ABUELA**  
2018  
Favaretto & Partners Design



**SPYKER**  
2018  
Studio Eurolinea Design

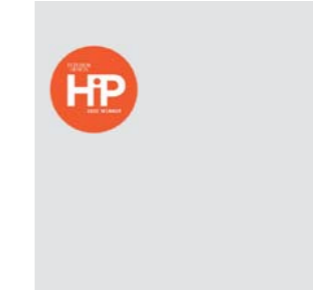

**JUBEL**  
2019  
Forsix Design



**FULLER**  
2019  
Marc Sadler Design



**STILLY**  
2014  
Studio Eurolinea Design



**ISIDORA ISIDORO**  
2015  
Favaretto & Partners Design



**CHOPPY**  
2015  
Favaretto & Partners Design



**AVENICA**  
2016  
Studio Eurolinea Design



**CUCARACHA**  
2019  
Favaretto & Partners Design



**SUNLOUNGER DOGE**  
2019  
Forsix Design

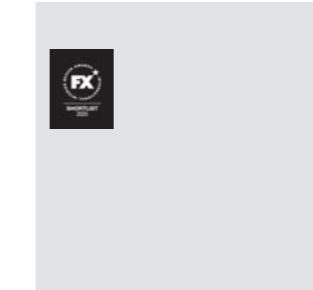

**NUTA**  
2019  
Favaretto & Partners Design



**AMITHA**  
2021  
Forsix Design



**PLACE**  
2016  
Favaretto & Partners Design



**DIAMANTE**  
2016  
Studio Eurolinea Design



**ELODIE**  
2016  
Marc Sadler Design



**CLIPPERTON**  
2017  
Marc Sadler Design

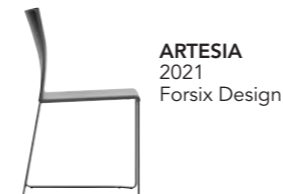

**ARTESIA**  
2021  
Forsix Design





# IN THE NATURAL AND ETHICAL RESPECT

## SUSTAINABLE PRODUCTS

Gaber designs, develops and produces furniture for the world of contract, responding to the needs of design, flexibility and quality thanks to the high level of expertise achieved in the molding of plastics and processing metal. Gaber both designs and produces, enabling the realization of innovative products that take into account both human and environmental safety. Since 2000, Gaber has avoided the use of pollutants and has instead encouraged the use of the most valued recycled materials. Gaber carefully launches products complying with the environmental laws in complete respect of the rules, thereby promoting the prevention of environmental pollution.

Safeguarding the environment and a continual search for eco-friendly solutions play an important role within our company where, in recent years, all new launches have been designed and manufactured with respect for our natural environment. This begins with the separate disposal of waste in both offices and on the factory floor: paper, cardboard, plastics, packaging, metal and glass are all separated out and recycled in other internal or external industrial processes, right up to self-sufficient energy production, thanks to the latest generation of photovoltaic (PV) solar panel systems.

## PRODOTTI SOSTENIBILI

Gaber progetta, sviluppa e produce arredi per il mondo del contract, rispondendo alle esigenze di design, flessibilità e qualità grazie all'alto livello di competenza raggiunto nello stampaggio delle materie plastiche e nella lavorazione del metallo. Gaber progetta e produce complementi d'arredo di design, permettendo la realizzazione di prodotti innovativi che tengano sempre conto della sicurezza umana e ambientale. Dal 2000 Gaber ha evitato l'uso di sostanze inquinanti, incoraggiando invece, l'uso dei materiali riciclati. Gaber, sempre attenta al lancio sul mercato di prodotti conformi alle più severe leggi di salvaguardia dell'ambiente, promuovendo così la prevenzione dell'inquinamento ambientale.

La salvaguardia dell'ambiente e la continua ricerca di soluzioni eco-compatibili giocano un ruolo importante all'interno dell'azienda dove tutti i nuovi prodotti sono progettati e realizzati nel rispetto dell'ambiente naturale. Iniziando con lo smaltimento separato dei rifiuti negli uffici e nelle aree produttive: carta, cartone, plastica, imballaggi, metallo e vetro sono accuratamente separati e riciclati grazie a processi industriali sia interni che esterni e continua sino alla produzione autonoma di energia grazie ad impianti fotovoltaici di ultima generazione.

# MATERIALS / MATERIALI



## TECHNOPOLYMER / TECNOPOLIMERO

Gaber production employs exclusively high-tech thermoplastic materials, which are 100% recyclable. Each techno-polymer item is marked with a specific symbol, which shows the kind of polymer for a quick identification and a consequent recycling. Gaber produces plastic injected materials without added chemicals. These materials are purchased within the European Union, so Gaber is exempted from registration with ECHA agency (European Agency for Chemicals Substances), in the complete respect of "Reach Regulation". As far as possible, recycled plastics are sourced as a base raw material, recovered post-consumption.

La produzione Gaber impiega esclusivamente materiali termoplastici altamente innovativi, riciclabili al 100%. Ogni articolo in tecnopolimero è contrassegnato da un simbolo specifico, che identifica il tipo di polimero per una rapida identificazione ed un conseguente corretto riciclaggio. Gaber produce materiali in tecnopolimero iniettato senza aggiunta di sostanze chimiche. Questi materiali sono acquistati all'interno dell'Unione Europea, pertanto Gaber è esente dalla registrazione presso l'agenzia ECHA (Agenzia europea per sostanze chimiche), nel pieno rispetto del "Reach Regulation". Per quanto possibile, i materiali plastici riciclati vengono acquistati come materia prima di base, recuperati da post-consumo.

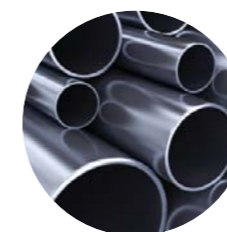

## METAL / METALLO

Gaber metal structures, in the full respect of our natural environment, are available with "trivalent" chroming and painted finishes. Prime-quality special epoxy powder coating used on Gaber frames enhance color stability from batch to batch and over time, increasing its corrosion resistance and achieving excellent resistance to atmospheric agents.

Le strutture metalliche Gaber, nel pieno rispetto del nostro ambiente naturale, sono disponibili con cromature "trivalenti" e finiture verniciate. La speciale verniciatura a polvere epossidica di prima qualità utilizzata sui telai Gaber migliora la stabilità del colore da lotto a lotto e nel tempo, aumentandone la resistenza alla corrosione e ottenendo un'ottima resistenza agli agenti atmosferici.





## WOOD / LEGNO

Wooden products are manufactured in accordance with the European Regulations in force regarding formaldehyde emissions from wood-based products (E1 according EN717-EN120). Gaber uses wooden raw materials coming from PEFC chain of custody certified materials.

I prodotti in legno sono realizzati in conformità alle Normative Europee vigenti in materia di emissioni di formaldeide da prodotti a base di legno (E1 secondo EN717-EN120). Gaber utilizza materie prime in legno provenienti da materiali certificati catena di custodia PEFC.



## PACKAGING / PACKAGING

Corrugated paperboard carton boxes, printed with environmentally friendly inks, are made of at least 80% recycled and recyclable materials, coming from the chain custody FSC Recycled. Packaging is sized in order to optimize storage and transport requirements, both helping the environment and saving on transport costs.

Le scatole di cartone ondulato, stampate con inchiostri ecologici, sono realizzate di almeno l'80% con materiali riciclati e riciclabili provenienti dalla catena di custodia FSC Recycled. Gli imballi sono dimensionati in modo da ottimizzare le esigenze di stoccaggio e trasporto, sia a favore dell'ambiente che di risparmio sui costi di trasporto.



## FUNCTION DESIGN AND SUSTAINABILITY / FUNZIONE DESIGN E SOSTENIBILITÀ

Compound Wood by Gaber is an advanced bio-composite where natural wood fibres are incorporated into a polyolefin matrix in order to produce a "Triple-way Ecological" material. This Triple Ecology is achieved by using wood shavings, in their turn completely recyclable, and without the need for any protective polluting treatments.

Compound Wood di Gaber è un Bio-Composito avanzato dove le fibre di legno naturali sono incorporate in una matrice poliolefinica per produrre un materiale "3 volte Ecologico". Ecologico 3 volte perché: utilizza derivati dalla lavorazione del legno, a loro volta completamente riciclabili e non necessita di trattamenti inquinanti protettivi del legno.



Gaber has received several awards for its sustainable Collections, including "Buygreen" award, a testament to Gaber's ongoing commitment to the innovation of its products and materials utilized.

Gaber ha ottenuto diversi riconoscimenti per le sue collezioni sostenibili, tra cui il premio "Buygreen", una testimonianza del continuo impegno di Gaber nell'innovazione dei suoi prodotti e dei materiali utilizzati.

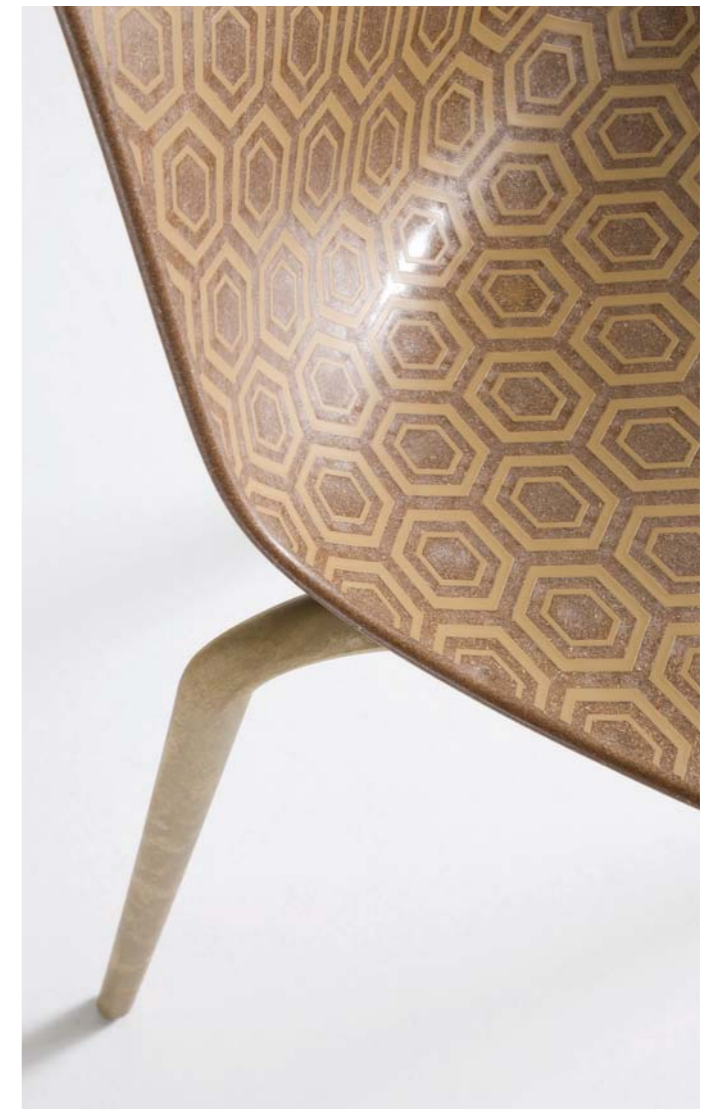

Contract and sustainable furniture







**Gaber technopolymer products are made with high quality raw materials: 100% recyclable and eco-friendly.**

In the **"ZERO WASTE"** collection, Gaber products are made of completely recycled plastic material: 50% from post-consumer certified plastic waste (PCR) and 50% from industrial plastic waste (PIR).

PCR is an abbreviation for "Post Consumer Recycled" and is the raw material made from waste from the consumer/end user. PIR is an abbreviation for "Post Industrial Recycled" and is the raw material made from waste generated within the industry.

Our know-how, the use of energy generated from renewable sources, combined with the most modern technologies utilized by Gaber for the reduction and recycling of waste, creates long-lasting and functional products, which help to reduce the environmental impact of our work.

However, sustainability does not stop at the sole use of **"ZERO WASTE"** material: this material, in fact, at the end of the product's life cycle, remains totally recyclable and therefore usable to create new products, consequently eliminating material waste. Gaber is therefore at the centre of a circular economic model aimed at increasingly sustainable development, providing services that can improve people's lives and the environment, with a vision of the future aimed at promoting responsible behaviour.

**I prodotti Gaber in tecnopolimero sono realizzati con materie prime di alta qualità: riciclabili al 100% ed eco-compatibili.**

Nella collezione **"ZERO WASTE"** il prodotto Gaber è realizzato in materiale plastico completamente riciclato: 50% da scarto di materiale plastico certificato post consumo (PCR) e 50% da scarto di materiale plastico industriale (PIR).

PCR è l'abbreviazione di "Post Consumer Recycled" ed è un materiale che deriva da prodotti precedentemente utilizzati dai consumatori. PIR è invece l'abbreviazione di "Post Industrial Recycled" ed è un materiale totalmente riciclato dagli scarti creati dal produttore in fabbrica, recuperato prima di essere utilizzato dal consumatore.

Il nostro know-how, l'utilizzo di energia generata da fonti rinnovabili, unito alle più moderne tecnologie utilizzate da Gaber per la riduzione e il riciclaggio degli scarti, crea prodotti longevi e funzionali, che aiutano a diminuire a priori l'impatto ambientale del nostro lavoro. La sostenibilità non si ferma però al solo utilizzo di materiale **"ZERO WASTE"**: tale materiale, infatti, alla fine del ciclo di vita del prodotto rimane totalmente riciclabile e quindi utilizzabile per creare nuovi prodotti, eliminando di conseguenza gli sprechi di materiale.

Gaber si pone quindi al centro di un modello economico circolare volto ad uno sviluppo sempre più sostenibile, fornendo servizi in grado di migliorare la vita delle persone e dell'ambiente, con una visione del futuro volta a promuovere comportamenti virtuosi.



### SAFE PRODUCTS / PRODOTTI SICURI

In all components, parts or materials used by Gaber to make its own products, be they plastic or metal, there are no dangerous substances within the certified limits of the following test methods reports:

In tutti i componenti, parti o materiali utilizzati da Gaber per realizzare i propri prodotti, siano essi plastici o metallici, non sono presenti sostanze pericolose nei limiti certificati dei seguenti metodi e rapporti di prova:

Cadmium/Cadmio UNI EN 13656:2004 + UNI EN 13657:2004 + UNI EN ISO 11885:2009  
 Lead/Piombo UNI EN 13656:2004 + UNI EN 13657:2004 + UNI EN ISO 11885:2009  
 Mercury/Mercurio UNI EN 13656:2004 + UNI EN 13657:2004 + UNI EN ISO 11885:2009  
 Arsenic/Arsenico UNI EN 13656:2004 + UNI EN 13657:2004 + UNI EN ISO 11885:2009  
 Selenium/Selenio UNI EN 13656:2004 + UNI EN 13657:2004 + UNI EN ISO 11885:2009  
 Chrome/Cromo VI CEI EN 62321:2009 Annex C  
 Diisobutil ftalato (DIBP) CPSC-CH-C1001-09.3:2010  
 Dibutil ftalato (DBP) CPSC-CH-C1001-09.3:2010  
 Benzilbutil ftalato (BBP) CPSC-CH-C1001-09.3:2010  
 Di-(2-etilesil) ftalato (DEHP) CPSC-CH-C1001-09.3:2010  
 Di-n-ottil ftalato (DNOP) CPSC-CH-C1001-09.3:2010  
 Diisononil ftalato (DINP) CPSC-CH-C1001-09.3:2010  
 Diisodecil ftalato (DIDP) CPSC-CH-C1001-09.3:2010  
 Dipentil ftalato (DPP) CPSC-CH-C1001-09.3:2010  
 Dimetossietil ftalato (DMEP) CPSC-CH-C1001-09.3:2010



Gaber Material "Plastomero/Elastomero" Report n. | Rapporto di prova n. 20205954-002  
 Gaber Material "Polipropilene" Report n. | Rapporto di prova n. 20205139-002  
 Gaber Material "Polipropilene R" Report n. | Rapporto di prova n. 20205139-004  
 Gaber Material "Polipropilene FVR" Report n. | Rapporto di prova n. 20205954-003  
 Gaber Material "Poliammide" Report n. | Rapporto di prova n. 20205139-003  
 Gaber Material "PC ABS" Report n. | Rapporto di prova n. 20205139-005  
 Gaber Material "POM" Report n. | Rapporto di prova n. 20205139-006  
 Gaber Material "Metal tube | Tubo Metallico" Report n. | Rapporto di prova n. 20205954-001  
 Gaber Material "Metal Screws-Inserts | Ferramenta Metallica" Report n. | Rapporto di prova n. 20205139-001  
 Gaber Composite Material "Castors | Ruote" Report n. | Rapporto di prova n. 20205139-007  
 Gaber Composite Material "Swivel columns | Colonne Girevoli" Report n. | Rapporto di prova n. 20205138-002





## RESEARCH AND DEVELOPMENT / RICERCA & SVILUPPO

Gaber, aware of the need to implement courageous initiatives that respond to the ambitious sustainability programme, follows new innovation targets: the new headquarters, with fully centralized integrated automation, allows remote management to minimize any waste of energy and materials.

Particular attention has been paid to bringing back the green that characterizes our landscape: more than 6'000m<sup>2</sup> have been regenerated, transforming concrete squares and asphalt into parkland, with more than 650 new plants introduced in order to balance production needs with the surrounding environment.



Gaber, consapevole della necessità di implementare iniziative coraggiose che rispondano all'ambizioso programma di sostenibilità, ricorre a nuove dimensioni dell'innovazione: la nuova sede, integralmente controllata da domotica, permette anche la gestione da remoto per minimizzare lo spreco, di energia e di materia.

Particolare attenzione è stata dedicata al riportare il verde che caratterizza il nostro paesaggio: più di 6'000m<sup>2</sup> sono stati rigenerati, trasformando piazzali in cemento e asfalto in prati, integrando con più di 650 nuove piante l'area, al fine di equilibrare le necessità produttive con l'ambiente circostante.

## RECYCLING UNIT

When a production chain works at its best, it also prevents the creation of waste, saves resources and reduces any impact on the environment. To ensure the sustainability of its activities, Gaber invests in latest generation technologies, thanks to which energy consumption is reduced and waste materials reused.

*Gaber Recycling Unit* is a division of Gaber that allows the recycling of plastic and metal materials from post-industrial consumption, automatically optimizing the separation of different raw materials, which are thus reused in subsequent production runs.

Quando una catena produttiva funziona al meglio, previene anche la creazione di rifiuti, risparmia risorse e riduce l'impatto nei confronti dell'ambiente. Per garantire la sostenibilità delle proprie attività, Gaber investe in tecnologie di ultima generazione, grazie alle quali viene ridotto il consumo di energia e vengono ri-utilizzate le materie di scarto.

*Gaber Recycling Unit* è una divisione di Gaber che permette il riciclo delle materie plastiche e metalliche da post consumo industriale, differenziando al meglio ed in modo automatico i diversi materiali componenti dei prodotti, che vengono così riutilizzati per una nuova produzione.



**TABLES**  
**Collection**

# Pareo

Forsix Design



Only for compactop / solo per compactop

Frame Color / Colore Struttura



Compactop Color / Colore Piano Compactop



Laminated Top Color / Colore Piano Laminato



Special Finishes / Finiture Speciali

**Compactop:** Special Compactop Surfaces Fullcolor (p. 163) available on demand (min. 5pcs each code).  
Special Compactop Surfaces Fullcolor (p. 163) disponibile su richiesta (min. 5pcs per codice).  
Special Compactop Surfaces 10 (p. 164) available on demand (min. 20pcs each code).  
Special Compactop Surfaces 10 (p. 164) disponibile su richiesta (min. 20pcs per codice).

**Laminated:** Special Laminated Surfaces Wood Effect 25 (p. 169) available on demand (min. 20pcs each code).  
Special Laminated Surfaces Wood Effect 25 (p. 169) disponibile su richiesta (min. 20pcs per codice).  
Special Laminated Surfaces Fenix 25 (p. 170) available on demand (min. 20pcs each code).  
Special Laminated Surfaces Fenix 25 (p. 170) disponibile su richiesta (min. 20pcs per codice).

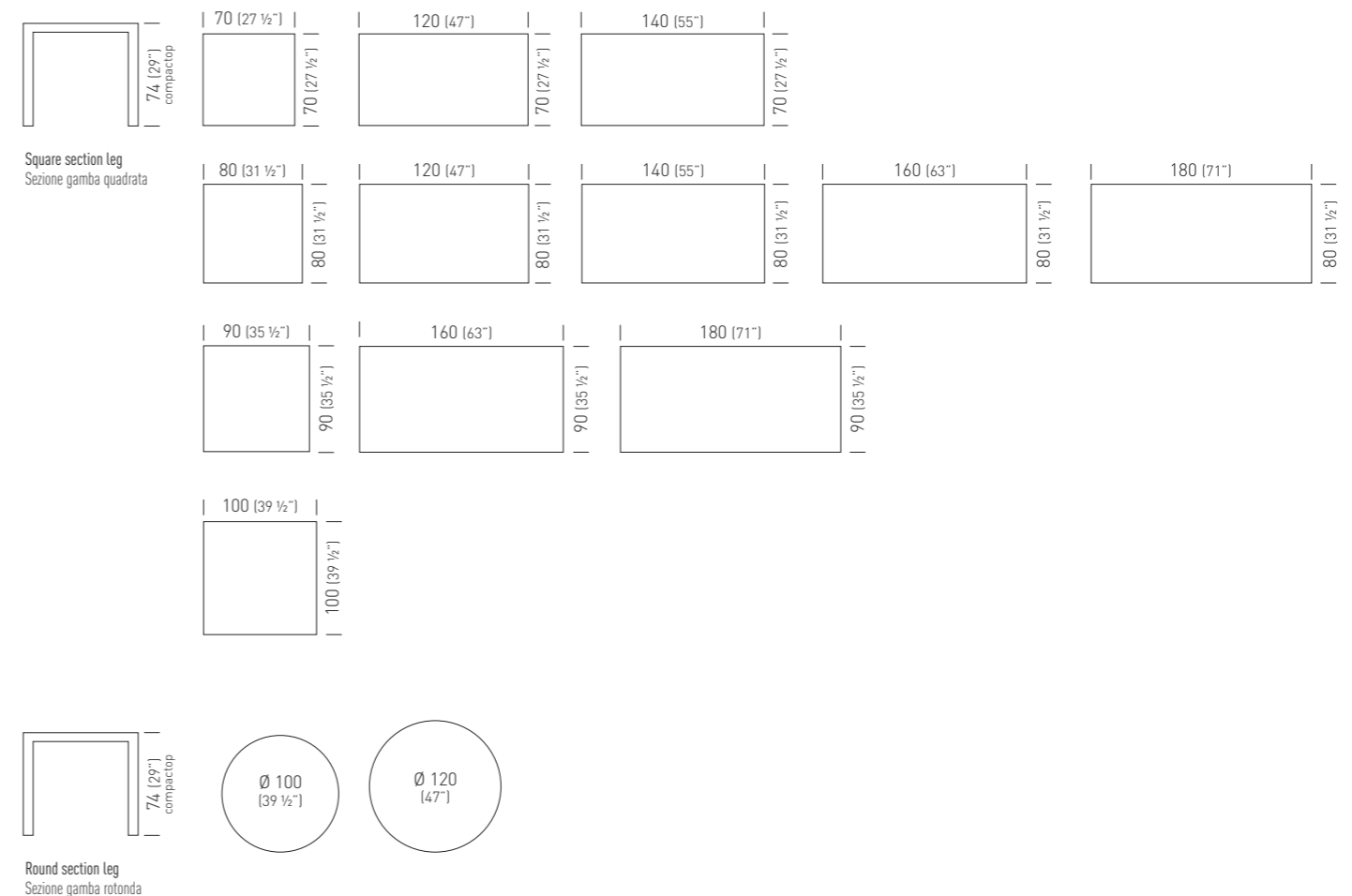

The Pareo Collection offers a wide range of beautifully designed dining and coffee tables. Thanks to their clean yet detailed design, Pareo tables suit a variety of hospitality settings, available in square, rectangular and round versions. The aluminum table frame, combined with Compact or Porcelain table tops, fits perfectly into even outdoor environments. Pareo Tables are made to be easily assembled and are available in a wide variety of bright frame colours and top finishes, perfectly matching your custom projects. La collezione Pareo offre una vasta gamma di tavoli e tavolini dal design accattivante. Grazie alle loro linee essenziali e curate, i tavoli Pareo si adattano a diversi stili dedicati all'ospitalità e sono disponibili nella versione quadrata, rettangolare o rotonda. La struttura del tavolo, realizzata in alluminio, abbinata ai piani in Compactop o Gres, si adatta perfettamente anche agli ambienti esterni. I tavoli Pareo sono realizzati per essere facilmente e velocemente assemblati e sono disponibili in un'ampia varietà di colori e finiture, perfetti per i vostri progetti personalizzati.



# Pareo Marble

Forsix Design



Frame Color / Colore Struttura

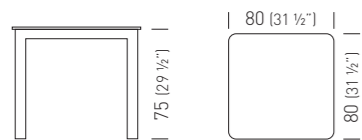
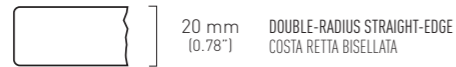

Round section leg  
Sezione gamba rotonda

The Pareo Marble tables utilizes a resistant aluminum and steel frame, fast and easy to assemble. The Marble tops, characterized by always different veins of natural stones, contribute to enhance elegance and refinement for the most demanding environments. The solid Marble surfaces, shiny and glossy, are treated to reduce their porosity, however constant care and cleaning of the product is recommended.

La collezione tavoli Pareo Marble utilizza un resistente telaio in alluminio e acciaio, facile ed intuitivo nell'assemblaggio. I piani in Marmo, caratterizzati dalle sempre diverse venature della pietra naturale, offrono eleganza e raffinatezza, per completare con esclusività gli ambienti più ricercati. I solidi piani in Marmo, splendidi e lucidi, sono trattati per ridurre la porosità, tuttavia si consiglia pulizia costante e cura nell'utilizzo del prodotto.

# Pareo Porcelain

Forsix Design



Frame Color / Colore Struttura

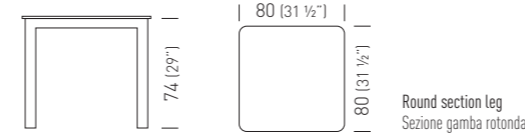
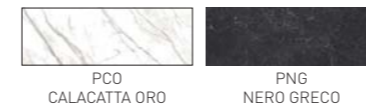
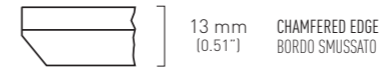

Round section leg  
Sezione gamba rotonda



Round section leg  
Sezione gamba rotonda

The Pareo Porcelain tables utilizes a resistant aluminum and steel frame, fast and easy to assemble. The Porcelain stoneware tops stand out for their excellent technical performance, ideal for the most delicate uses where maximum hygiene and resistance must be guaranteed. Porcelain tops are compatible with foodstuffs, resistant to fungi and molds, suitable for both indoor and outdoor use, resistant to frost, heat and high temperatures, they can be cleaned very easily while maintaining the characteristics of the surface.

La collezione tavoli Pareo Porcelain utilizza un resistente telaio in alluminio e acciaio, facile ed intuitivo nell'assemblaggio. I piani in Gres Porcellanato si distinguono per le eccellenti performance tecniche, ideali negli impieghi più delicati nei quali è necessario garantire la massima igiene e resistenza. I piani Porcelain sono compatibili con le sostanze alimentari, resistenti a funghi e muffe, idonei ad un utilizzo sia interno che esterno, resistenti al gelo, al calore a alle alte temperature, si possono pulire con estrema facilità mantenendo inalterate le caratteristiche della superficie.



# Norman

Forsix Design



The Norman table collection is made using basic geometries to achieve distinctly shapes. Available with round or square Laminate, Compactop or Marble tops, Norman utilizes a 4 legged aluminum frame, available in many vibrant colours.

La collezione di Tavoli Norman è realizzata utilizzando geometrie semplici e forme essenziali. Disponibile con piani rotondi o quadrati in Laminato, Compactop o Marmo, Norman utilizza una struttura 4 gambe in alluminio, disponibile in vari colori di tendenza.







Only for Compactop and Steel tops  
Solo per piani in compactop e acciaio



Frame colors / Colori struttura



Compactop Color / Colore Piano Compactop



Laminated Top Color / Colore Piano Laminato



Steel Top Color / Colori Top Steel



Special Finishes / Finiture Speciali

**Compactop:** Special Compactop Surfaces Fullcolor (p.163) white available on demand (min. 5pcs each code).  
Special Compactop Surfaces Fullcolor (p.163) bianco disponibile su richiesta (min. 5pcs per codice).

**Laminated:** Special Laminated Surfaces Wood Effect 25 (p. 169) available on demand (min. 20pcs each code).  
Special Laminated Surfaces Wood Effect 25 (p. 169) disponibile su richiesta (min. 20pcs per codice).  
Special Laminated Surfaces Fenix 25 (p. 170) available on demand (min. 20pcs each code).  
Special Laminated Surfaces Fenix 25 (p. 170) disponibile su richiesta (min. 20pcs per codice).

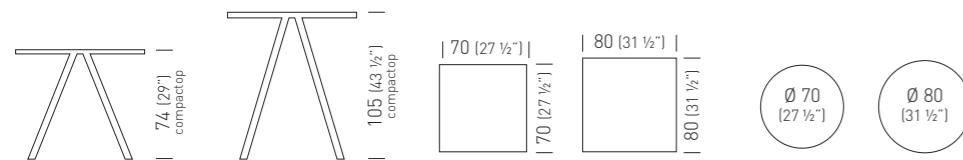

# Norman Marble

Forsix Design



Frame colors / Colori struttura



20 mm (0.78") DOUBLE-RADIUS STRAIGHT-EDGE COSTA RETTA BISELLATA

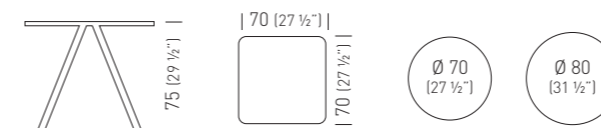
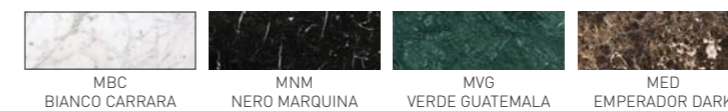

The Norman table collection utilizes a 4 legged aluminum frame, available in many vibrant colours. The Marble tops, characterized by always different veins of natural stones, contribute to enhance elegance and refinement for the most demanding environments. The solid Marble surfaces, shiny and glossy, are treated to reduce their porosity, however constant care and cleaning of the product is recommended.

La collezione di Tavoli Norman utilizza una struttura 4 gambe in alluminio, disponibile in vari colori di tendenza. I piani in Marmo, caratterizzati dalle sempre diverse venature della pietra naturale, offrono eleganza e raffinatezza, per completare con esclusività gli ambienti più ricercati. I solidi piani in Marmo, splendenti e lucidi, sono trattati per ridurre la porosità, tuttavia si consiglia pulizia costante e cura nell'utilizzo del prodotto.



# Surfy 2027 Tables & Desks

Studio Eurolinea Design



Table collection, meeting tables and modular desks, part of the "2027" system, suitable for completing hospitality and office settings with integrated design. The tables are made with painted metal structures and Laminate or Compactop table-tops, available with metal fairlead solutions.

Collezione tavoli, tavoli meeting e scrivanie modulari, parte del sistema "2027", adatti a completare con lo stesso design progetti integrati di ospitalità ed ufficio. I tavoli sono realizzati con strutture in metallo verniciato e piani in Laminato o Compactop, disponibili con soluzioni passacavi in metallo. Strutture di sostegno con forma a cavalletto per essere snelle e resistenti, oltre che colorate a tutto tondo.





### SURFY HUB 2027 ROUND



Frame colors / Colori struttura



Laminated Top Color / Colore Piano Laminato



### SURFY OUTDOOR 2027 ROUND



Frame colors / Colori struttura



Compactop Top Color / Colore Piano Compactop



### SURFY HUB 2027 SQUARE



Frame colors / Colori struttura



Laminated Top Color / Colore Piano Laminato

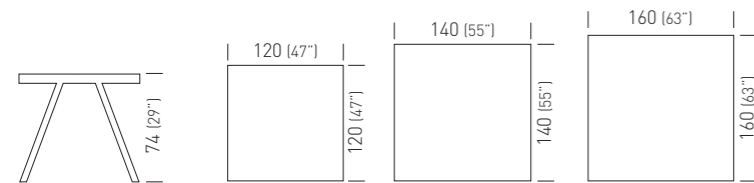

### SURFY OUTDOOR 2027 SQUARE



Frame colors / Colori struttura



Compactop Top Color / Colore Piano Compactop

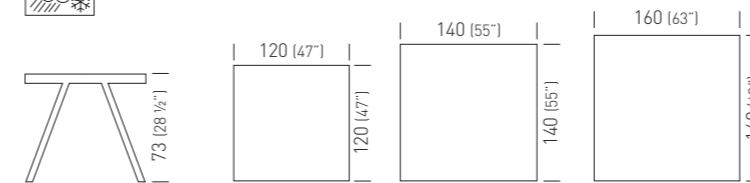

Special Finishes / Finiture Speciali

**Compactop:** Special Compactop Surfaces Fullcolor (p. 163) available on demand (min. 5pcs each code).  
Special Compactop Surfaces Fullcolor (p. 163) disponibile su richiesta (min. 5pcs per codice).  
Special Compactop Surfaces (p. 164) available on demand (min. 20pcs each code).  
Special Compactop Surfaces (p. 164) disponibile su richiesta (min. 20pcs per codice).

**SURFY HUB 2027 OVAL**



Frame colors / Colori struttura



Laminated Top Color / Colore Piano Laminato

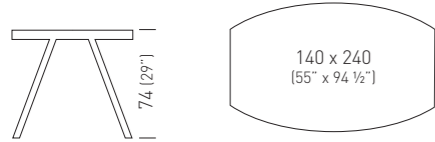

**SURFY HUB 2027 RECTANGLE**



Frame colors / Colori struttura



Laminated Top Color / Colore Piano Laminato

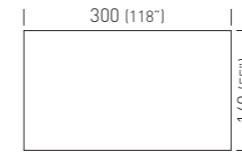
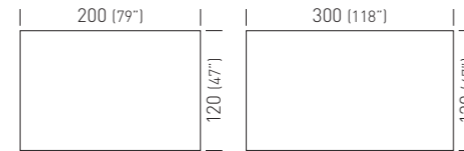
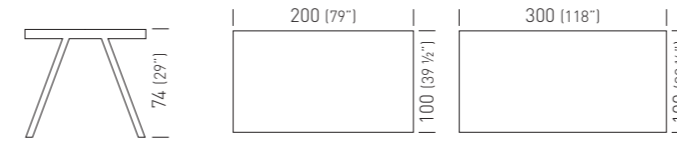

**SURFY HUB 2027 RECTANGLE**



Frame colors / Colori struttura

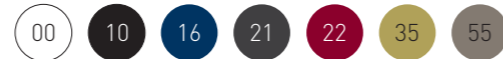

Laminated Top Color / Colore Piano Laminato

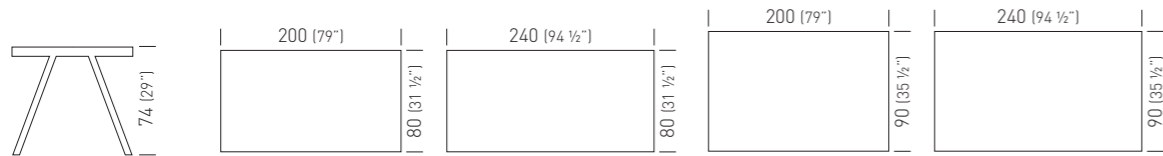
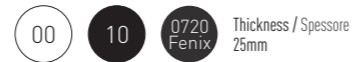



## SURFY DESK 2027

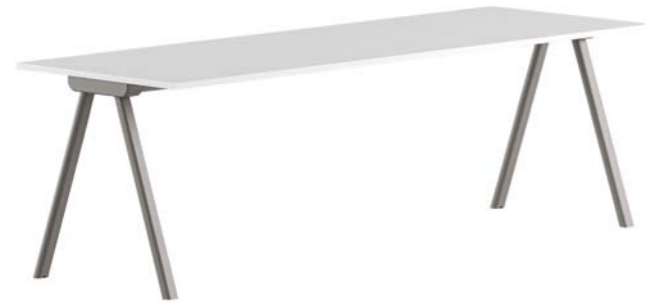

Frame colors / Colori struttura



Laminated Top Color / Colore Piano Laminato



Thickness / Spessore  
28mm

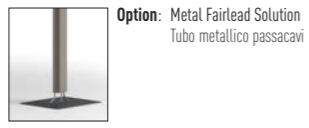
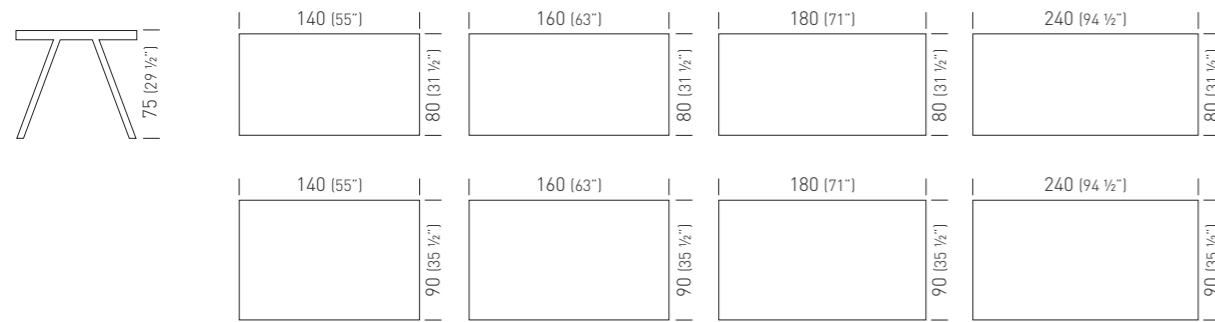

Colors / Colori



Laminated Top Color / Colore Piano Laminato



Thickness / Spessore  
28mm

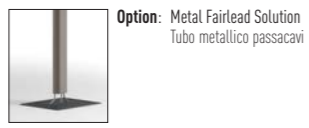
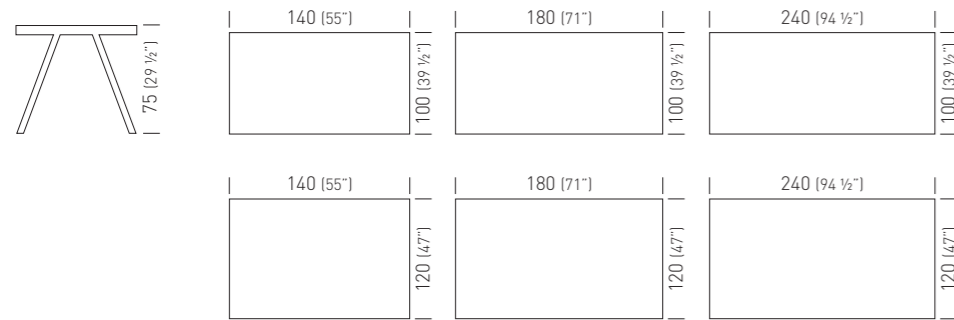

Colors / Colori



## SURFY DESK L VERSION



Frame colors / Colori struttura



Laminated Top Color / Colore Piano Laminato



Thickness / Spessore  
28mm

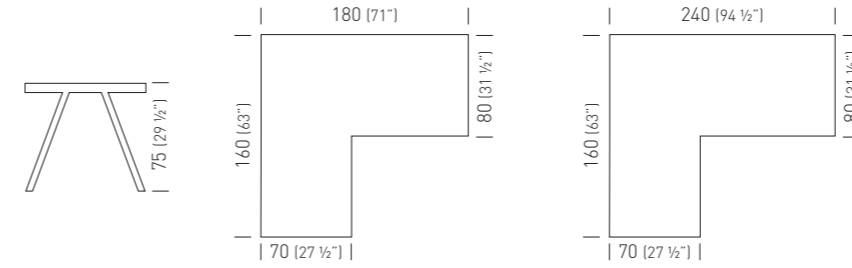

Colors / Colori



## SURFY DESK BRIDGE 2027



Frame colors / Colori struttura



Laminated Top Color / Colore Piano Laminato



Thickness / Spessore  
28mm

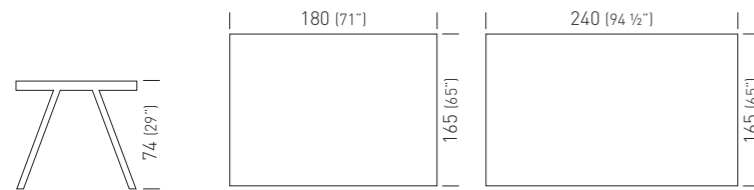

**Option:** Cable Routing Option, anodized Aluminum 8x8 cm, black brush  
Opzione Passacavi, Alluminio anodizzato 8x8 cm spazzolina nera



**Option:** Metal Fairlead Solution  
Tubo metallico passacavi

Colors / Colori



## SURFY HIGH DESK 2027



Frame colors / Colori struttura



Laminated Top Color / Colore Piano Laminato



Thickness / Spessore  
28mm

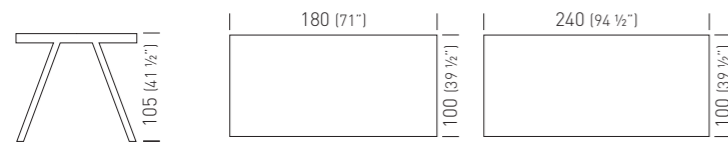

**Option:** Cable Routing Option, anodized Aluminum 8x8 cm, black brush  
Opzione Passacavi, Alluminio anodizzato 8x8 cm spazzolina nera



**Option:** Metal Fairlead Solution  
Tubo metallico passacavi

Colors / Colori



# Surfy Outdoor 2027 Coffee Table

Studio Eurolinea Design

Waiting areas and Coffee Table, Compactop with three metal legs frame.  
Tavolino attesa con piano in Compactop e struttura a tre gambe in metallo.



Frame colors / Colori struttura



Special Finishes / Finiture Speciali

**Compactop:** Special Compactop Surfaces Fullcolor (p. 163) available on demand (min. 5pcs each code).  
Special Compactop Surfaces Fullcolor (p. 163) disponibile su richiesta (min. 5pcs per codice).

Compactop Color / Colore Piano Compactop



# Surfy Hub 2027 Coffee Table

Studio Eurolinea Design

Waiting areas and Coffee Table, Laminated Table Top with four metal legs frame.  
Tavolino attesa con piano in Laminato e struttura a 4 gambe in metallo.



Frame colors / Colori struttura



Laminated Top Color / Colore Piano Laminato

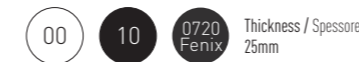

Thickness / Spessore  
25mm

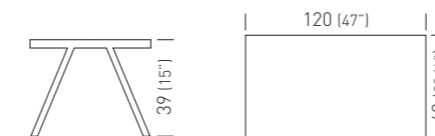



# Arket

Studio Eurolinea Design



Colors / Colori



The new Arket table collection is made using basic geometrics - radii and linear sections intersect to achieve distinctly intuitive shapes.

The aluminum bases have three or four spokes with adjustable feet, and the stems come in sections with three or four surfaces.

The table tops are made of steel: the tables are thus painted in a solid color and easily customizable and adaptable to the most prestigious of installations.

La nuova collezione di tavoli Arket è realizzata utilizzando le geometrie più elementari, raggi e sezioni lineari si intersecano per ricavare forme essenziali ed intuitive.

I basamenti, a tre o quattro razze, con piedini regolabili, e gli steli, a sezioni con tre o quattro superfici, sono realizzati in alluminio.

I piani sono realizzati in acciaio: i tavoli sono così verniciati in tinta unita e facilmente personalizzabili ed adattabili alle più prestigiose installazioni.

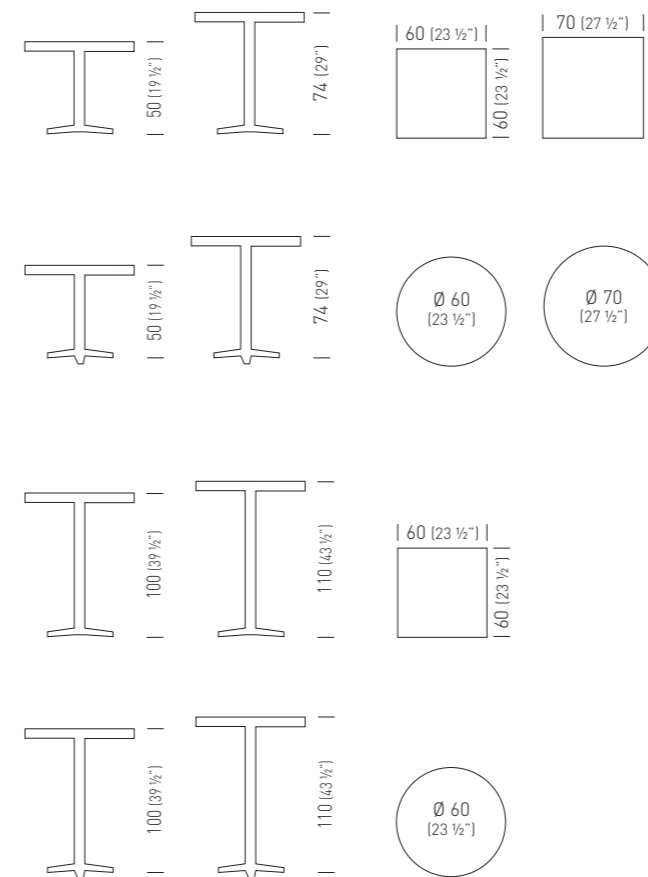

# Arket Porcelain

Forsix Design

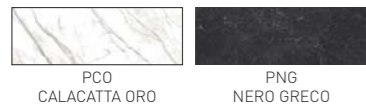

Frame colors / Colori struttura

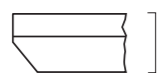

13 mm (0.51")  
CHAMFERED EDGE  
BORDO SMUSSATO

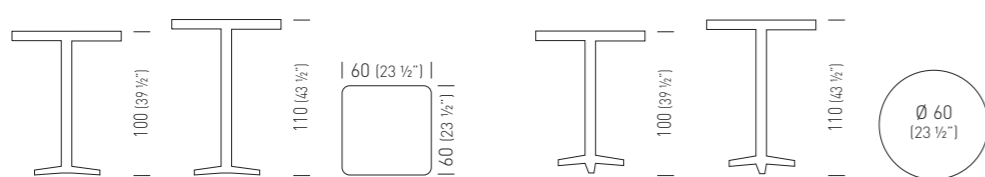
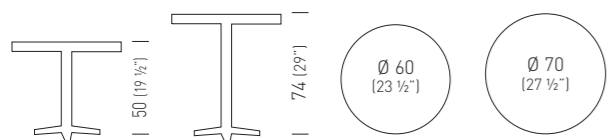
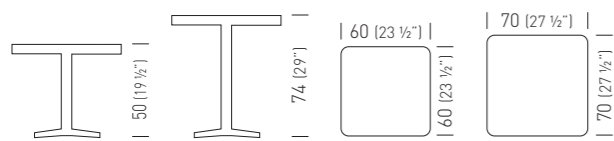

The Porcelain stoneware tops stand out for their excellent technical performance, ideal for the most delicate uses where maximum hygiene and resistance must be guaranteed. Porcelain tops are compatible with foodstuffs, resistant to fungi and molds, suitable for both indoor and outdoor use, resistant to frost, heat and high temperatures, they can be cleaned very easily while maintaining the characteristics of the surface.

I piani in Gres Porcellanato si distinguono per le eccellenti performance tecniche, ideali negli impieghi più delicati nei quali è necessario garantire la massima igiene e resistenza. I piani Porcelain sono compatibili con le sostanze alimentari, resistenti a funghi e muffe, idonei ad un utilizzo sia interno che esterno, resistenti al gelo, al calore e alle alte temperature, si possono pulire con estrema facilità mantenendo inalterate le caratteristiche della superficie.

# Arket Plus

Forsix Design



Colors / Colori

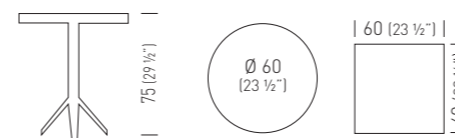

Arket Plus Collection is made using basic geometrics, achieving distinctly intuitive shapes. The table tops are made of steel, the three spokes bases are made of co-injected metal and techno-polymer. Stem and cross are made in aluminum, and provided with flip-top joint. The shape of the base and the flip-top mechanism allow the table to easily fold and stack, space-saving.

La Collezione di tavoli Arket Plus è realizzata utilizzando le geometrie più elementari, ottenendo così forme essenziali ed intuitive. I piani del tavolo sono realizzati in acciaio, la base a tre razze è costituita da una struttura in metallo co-iniettata con tecnopolimero. Colonna e crociera sono realizzate in alluminio, dotate di giunto per la rotazione del piano. La forma della base e la meccanica che permette la rotazione del piano rendono il tavolo facilmente accatatabile in spazi ridotti.



# Lol

Forsix Design



Colors / Colori



The "Lol" table collection is intended for outdoor use; youthfully simple and sunny, its design blends in discreetly with either the most sparkling or the most sober environments. The table tops with composite material core, as well as the bases, available with three or four spokes, are made up of a metal structure treated for outdoor use, and with a matt finish. The available colour palette is common to many Gaber seating collections, guaranteeing tone-on-tone colour co-ordination throughout designed settings rather than lively contrasts, defining various colour combinations between bases, tops and seating.

La collezione di tavoli Lol, disegnata da Forsix, è ideale per l'utilizzo all'aria aperta: giovane, semplice e solare, il suo design si fonde con discrezione dagli ambienti più sobri a quelli più frizzanti. I piani del tavolo, dal cuore in materiale composito, come anche i basamenti, disponibili a tre o quattro razze, sono costituiti da una struttura in metallo trattata per esterni, dalla finitura opaca. La palette di colori disponibile è comune a molte collezioni di sedute Gaber, garantendo abbinamenti tono su tono degli ambienti progettati, piuttosto che vivaci contrasti, definendo diverse combinazioni di colori tra basi, piani e sedute.

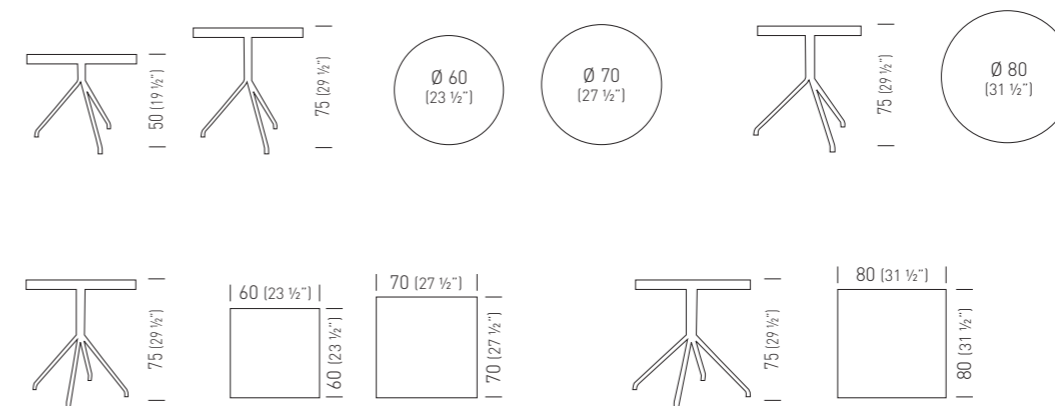

# Lol Marble

Forsix Design



Frame colors / Colori struttura

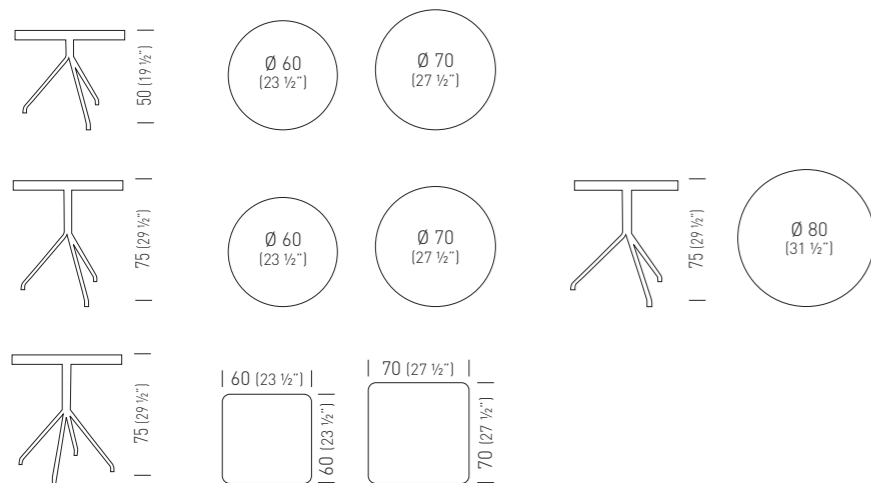
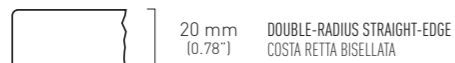

# Lol Porcelain

Forsix Design



Frame colors / Colori struttura

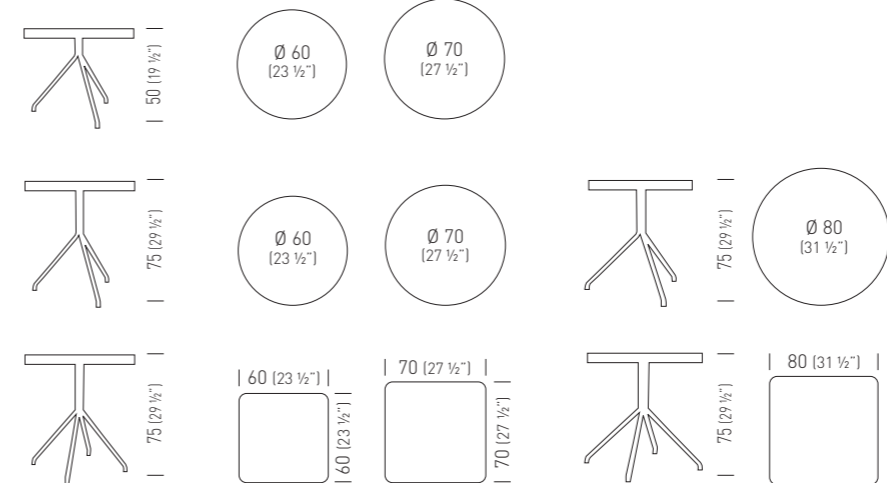
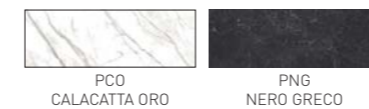

The Lol tables collection is enriched with new Marble tops, with round or square shapes, thus adapting to the most prestigious installations. The Marble tops, characterized by always different veins of natural stones, contribute to enhance elegance and refinement for the most demanding environments. The solid Marble surfaces, shiny and glossy, are treated to reduce their porosity, however constant care and cleaning of the product is recommended.

La collezione di tavoli Lol si arricchisce di nuovi piani in Marmo, dalle forme rotonde o quadrate, adattandosi così alle più prestigiose installazioni. I piani in Marmo, caratterizzati dalle sempre diverse venature della pietra naturale, offrono eleganza e raffinatezza, per completare con esclusività gli ambienti più ricercati. I solidi piani in Marmo, splendidi e lucidi, sono trattati per ridurre la porosità, tuttavia si consiglia pulizia costante e cura nell'utilizzo del prodotto.

The Lol tables collection is enriched with new Porcelain tops, with round or square shapes, thus adapting to the most prestigious installations. The Porcelain stoneware tops stand out for their excellent technical performance, ideal for the most delicate uses where maximum hygiene and resistance must be guaranteed. Porcelain tops are compatible with foodstuffs, resistant to fungi and molds, suitable for both indoor and outdoor use, resistant to frost, heat and high temperatures, they can be cleaned very easily while maintaining the characteristics of the surface.

La collezione di tavoli Lol si arricchisce di nuovi piani in Gres Porcellanato, dalle forme rotonde o quadrate, adattandosi così alle più prestigiose installazioni. I piani in Gres Porcellanato si distinguono per le eccellenti performance tecniche, ideali negli impieghi più delicati nei quali è necessario garantire la massima igiene e resistenza. I piani Porcelain sono compatibili con le sostanze alimentari, resistenti a funghi e muffe, idonei ad un utilizzo sia interno che esterno, resistenti al gelo, al calore e alle alte temperature, si possono pulire con estrema facilità mantenendo inalterate le caratteristiche della superficie.



# Lol Plus

Forsix Design



Colors / Colori

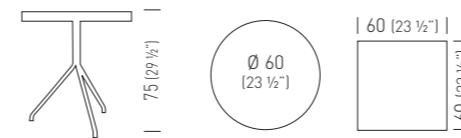

The Lol Plus tables collection is made of steel, the cross is made in aluminum, and provided with flip-top joint. The shape of the base and the flip-top mechanism allow the table to easily fold and stack, space-saving. The available colour palette is common to many Gaber seating collections, guaranteeing tone-on-tone colour co-ordination throughout designed settings rather than lively contrasts, defining various colour combinations between bases, tops and seating.

La Collezione di tavoli Lol Plus è realizzata in acciaio, la crociera è realizzata in alluminio, ed è dotata di giunto per la rotazione del piano.

La forma della base e la meccanica che permette la rotazione del piano in posizione verticale, rendono il tavolo facilmente accatastabile in spazi ridotti. La palette di colori disponibile è comune a molte collezioni di sedute Gaber, garantendo abbinamenti tono su tono degli ambienti progettati, piuttosto che vivaci contrasti, definendo diverse combinazioni di colori tra basi, piani e sedute.

# Glitter

Forsix Design



Frame Color / Colore Struttura



Compactop Color / Colore Piano Compactop



Laminated Top Color / Colore Piano Laminato



Special Finishes / Finiture Speciali

**Compactop:** Special Compactop Surfaces Fullcolor (p. 163) available on demand (min. 5pcs each code).  
Special Compactop Surfaces Fullcolor (p. 163) disponibile su richiesta (min. 5pcs per codice).  
Special Compactop Surfaces Fenix (p. 166) available on demand (min. 20pcs each code).  
Special Compactop Surfaces Fenix (p. 166) disponibile su richiesta (min. 20pcs per codice).  
Special Compactop Surfaces 10 (p. 164) available on demand (min. 20pcs each code).  
Special Compactop Surfaces 10 (p. 164) disponibile su richiesta (min. 20pcs per codice).

**Laminated:** Special Laminated Surfaces Wood Effect (p. 169) available on demand (min. 20pcs each code).  
Special Laminated Surfaces Wood Effect (p. 169) disponibile su richiesta (min. 20pcs per codice).  
Special Laminated Surfaces Fenix (p. 170) available on demand (min. 20pcs each code).  
Special Laminated Surfaces Fenix (p. 170) disponibile su richiesta (min. 20pcs per codice).

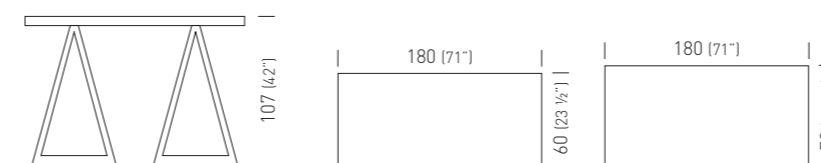
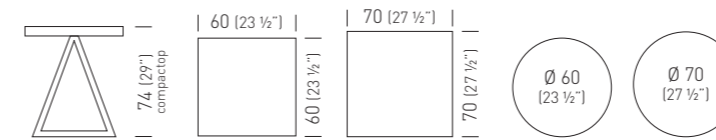

Laminated Top  
Piano Laminato



# Bristol

Forsix Design

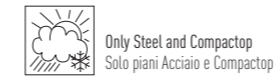

Frame Color / Colore Struttura



Compactop Color / Colore Piano Compactop



Laminated Top Color / Colore Piano Laminato



Steel Top Color / Colore Piano Acciaio

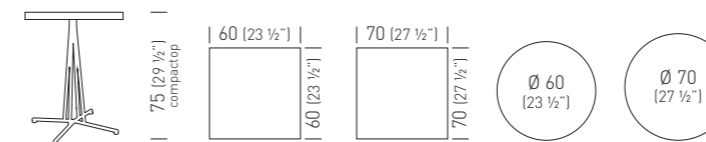

The Bristol table is characterized by bold lines and tone-on-tone colours, suitable for setting off to a tee the most refined hospitality environments. Its top and four-spur base, equipped with adjustable feet, are in epoxy powder coated steel treated for outdoor use.

Il tavolo Bristol è caratterizzato da linee decise e dai colori tono su tono, adatto a diventare protagonista degli ambienti dell'ospitalità più ricercati. Il piano e il basamento a quattro razze, dotato di piedini regolabili, sono realizzati in acciaio verniciato a polveri epossidiche con trattamento per esterno.

Special Finishes / Finiture Speciali

**Compactop:** Special Compactop Surfaces Fullcolor (p. 163) available on demand (min. 5pcs each code).  
Special Compactop Surfaces Fullcolor (p. 163) disponibile su richiesta (min. 5pcs per codice).  
Special Compactop Surfaces Fenix (p. 166) available on demand (min. 20pcs each code).  
Special Compactop Surfaces Fenix (p. 166) disponibile su richiesta (min. 20pcs per codice).  
Special Compactop Surfaces 10 (p. 164) available on demand (min. 20pcs each code).  
Special Compactop Surfaces 10 (p. 164) disponibile su richiesta (min. 20pcs per codice).

**Laminated:** Special Laminated Surfaces Wood Effect (p. 169) available on demand (min. 20pcs each code).  
Special Laminated Surfaces Wood Effect (p. 169) disponibile su richiesta (min. 20pcs per codice).  
Special Laminated Surfaces Fenix (p. 170) available on demand (min. 20pcs each code).  
Special Laminated Surfaces Fenix (p. 170) disponibile su richiesta (min. 20pcs per codice).

# Azione Adjustable Desk

Forsix Design



"Azione", Sit-Stand desk table, height adjustable, equipped with bluetooth controller and anti-collision technology.

"Azione", tavolo scrivania Sit-Stand, regolabile elettricamente in altezza, dotato di controller bluetooth e tecnologia anticollisione.

Frame Color / Colore Struttura



Laminated Top Color / Colore Piano Laminato



	140 (55")	160 (63")	180 (71")
	80 (31 1/2")	80 (31 1/2")	80 (31 1/2")
	140 (55")	160 (63")	180 (71")
	90 (35 1/2")	90 (35 1/2")	90 (35 1/2")



# Flipaway

Forsix Design



Frame Color / Colore Struttura



Laminated Top Color / Colore Piano Laminato

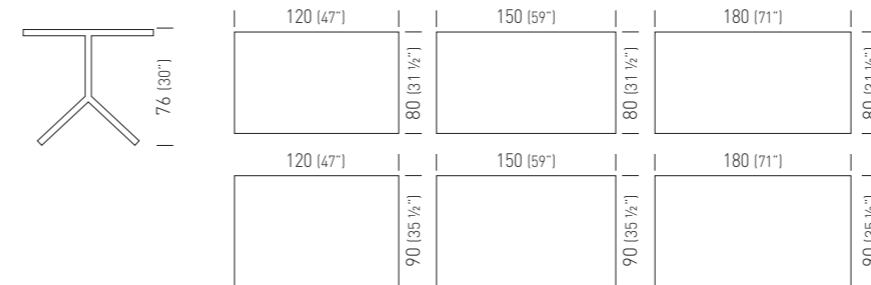

"Flipaway" table for conference environment, provided with laminated table top and breaking castors, ensures complete frontal stackability.

"Flipaway": tavolo con piano in laminato adatto ad ambienti conferenza, accatastabile frontalmente e dotato di ruote con freno.





# Login

Studio Eurolinea Design



Frame Color / Colore Struttura



Laminated Top Color / Colore Piano Laminato



Special Finishes / Finiture Speciali

**Laminated:** Special Laminated Surfaces Wood Effect 25 (p. 169) available on demand (min. 20pcs each code)  
Special Laminated Surfaces Wood Effect 25 (p. 169) disponibile su richiesta (min. 20pcs per codice)  
Special Laminated Surfaces Fenix 25 (p. 170) available on demand (min. 20pcs each code)  
Special Laminated Surfaces Fenix 25 (p. 170) disponibile su richiesta (min. 20pcs per codice)

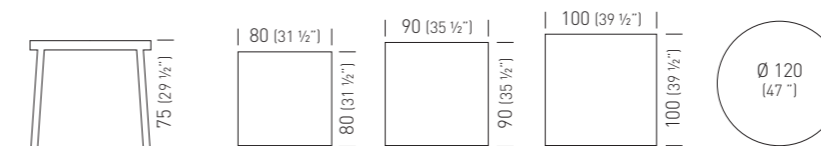



# Agile

Studio Eurolinea Design



The multifunctional Agile Table Collection reveals essential aesthetics. Available with rectangular solid laminate tops, the Agile Collection utilizes techno-polymer legs in different colors, supported by a steel frame. Agile è una collezione di tavoli multifunzionale dall'estetica ricercata ed essenziale. Realizzato con piani rettangolari in laminato, Agile utilizza gambe in tecnopolimero in diverse colorazioni, supportate da una cornice in acciaio.

Technopolymer Frame Color / Colore Struttura Tecnopolimero



Laminated Top Color / Colore Piano Laminato



Special Finishes / Finiture Speciali

**Laminated:** Special Laminated Surfaces Wood Effect 25 (p. 169) available on demand (min. 20pcs each code)  
Special Laminated Surfaces Wood Effect 25 (p. 169) disponibile su richiesta (min. 20pcs per codice)  
Special Laminated Surfaces Fenix 25 (p. 170) available on demand (min. 20pcs each code)  
Special Laminated Surfaces Fenix 25 (p. 170) disponibile su richiesta (min. 20pcs per codice)

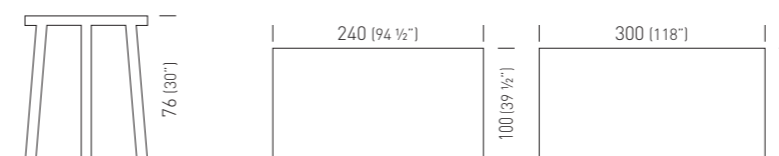

# Charme

Studio Eurolinea Design



Colors / Colori

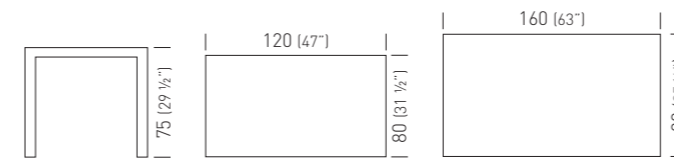

Elegance and essential shapes find a new expression in the Charme table, a proposal designed for workspace and hospitality environments, which is characterized by the particular design of the metal legs.

The regular shapes harmonize each other, creating a product also suitable for conviviality, thanks to the top in "Iron" composite material which highlights great stability and resistance.

Eleganza ed essenzialità trovano una nuova espressione nel tavolo Charme, una proposta ideata per lo spazio di lavoro e dell'ospitalità, che si caratterizza per il particolare design delle gambe in metallo.

Le forme regolari si armonizzano tra loro, dando vita a un progetto improntato anche alla convivialità, grazie al piano in materiale composito "Iron" dalla grande stabilità e resistenza.





# Together

Marc Sadler Design



Natural Oak wood table top and polycarbonate legs:  
transparent, solid white, solid black.  
Tavolo con piano in legno di rovere,  
gambe in policarbonato trasparente, bianche o nere.

Technopolymer Frame Color / Colore Struttura Tecnopolimero



Top Color / Colore Piano

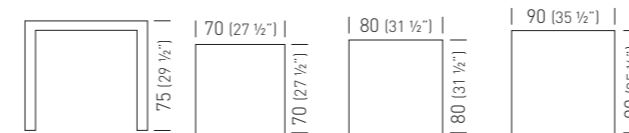

# Together

Marc Sadler Design



Together is a solid and versatile table, suitable to be utilized with elegance in all modern environments. The legs, made of natural solid oak, are combined with a natural oak veneered top, thus obtaining a pleasant visual play of solid interlocking between the leg and the top. With a simple and elegant design, Together adapts to any decorative context, expressing the warmth of wood and its small details. The legs are always at the extreme of tops sizes.

Together è un tavolo solido e versatile, adatto ad essere inserito con eleganza in tutti gli ambienti moderni. Le gambe, realizzate in rovere massello naturale, sono abbinare ad un piano impiallacciato rovere naturale, ottenendo così un piacevole gioco visivo di solido incastro tra la gamba e il piano. Dal design semplice ed elegante, Together si adatta a qualunque contesto decorativo esprimendo il calore del legno ed i suoi piccoli dettagli. Le gambe restano sempre all' estremo.

Wooden Frame Color / Colore Struttura Legno

RN

Top Color / Colore Piano

RN

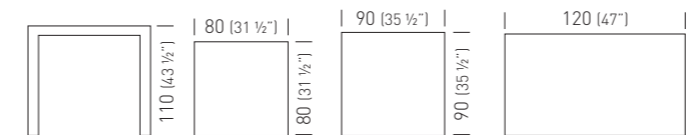
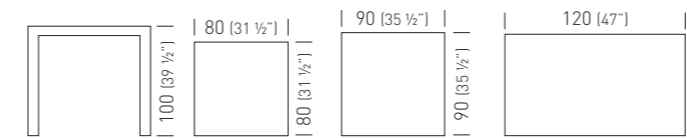
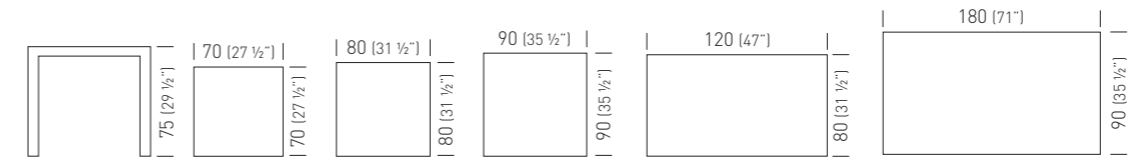



# Stefano

Studio Eurolinea Design



Wooden Frame Color / Colore Struttura Legno



Top Color / Colore Piano



Special Finishes / Finiture Speciali

**Compactop:** Special Compactop Surfaces 10 (p. 164) available on demand (min. 20pcs each code).  
Special Compactop Surfaces 10 (p. 164) disponibile su richiesta (min. 20pcs per codice).

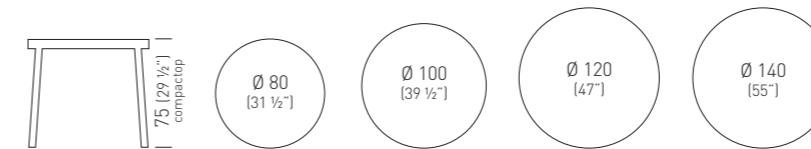

Technopolymer Frame Color / Colore Struttura Tecnopolimero



Top Color / Colore Piano



Special Finishes / Finiture Speciali

**Compactop:** Special Compactop Surfaces 10 (p. 164) available on demand (min. 20pcs each code).  
Special Compactop Surfaces 10 (p. 164) disponibile su richiesta (min. 20pcs per codice).

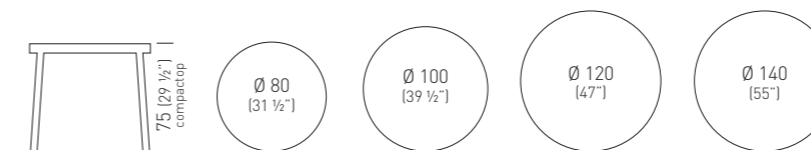



# Stefano

Studio Eurolinea Design



Compactop table-top and beech legs.  
Or with technopolymer legs,  
suitable for outdoor use. Lightweight and functional.  
Tavolo con piano Compactop e gambe in legno di faggio.  
Disponibile anche con gambe in tecnopolimero,  
adatte all'uso esterno. Leggero e funzionale.

Wooden Frame Color / Colore Struttura Legno



Top Color / Colore Piano



Special Finishes / Finiture Speciali

**Compactop:** Special Compactop Surfaces 10 (p. 164) available on demand (min. 20pcs each code).  
Special Compactop Surfaces 10 (p. 164) disponibile su richiesta (min. 20pcs per codice).

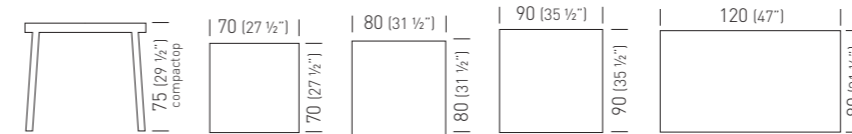

Technopolymer Frame Color / Colore Struttura Tecnopolimero



Top Color / Colore Piano



Special Finishes / Finiture Speciali

**Compactop:** Special Compactop Surfaces 10 (p. 164) available on demand (min. 20pcs each code).  
Special Compactop Surfaces 10 (p. 164) disponibile su richiesta (min. 20pcs per codice).

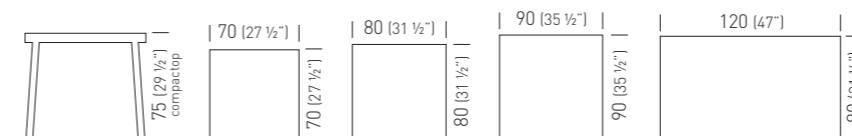



# Stefano 3-Pod

Studio Eurolinea Design



Wooden Frame Color / Colore Struttura Legno



Top Color / Colore Piano



Special Finishes / Finiture Speciali

**Compactop:** Special Compactop Surfaces Fullcolor (p. 163) white available on demand (min. 5pcs each code).  
Special Compactop Surfaces Fullcolor (p. 163) bianco disponibile su richiesta (min. 5pcs per codice).

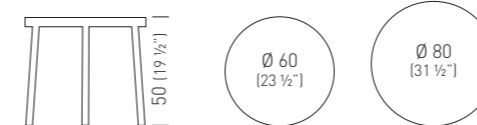

Waiting areas and Coffee Table,  
Compactop with three beech legs.  
Tavolino attesa con piano Compactop  
e tre gambe in legno di faggio.

# Stefanino

Studio Eurolinea Design



Wooden Frame Color / Colore Struttura Legno



Top Color / Colore Piano



Fullcolor

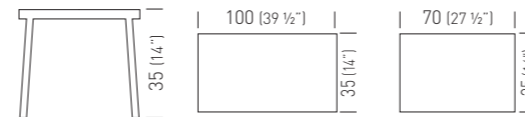

Waiting areas and Coffee Table,  
Compactop with beech legs.  
Tavolino attesa con piano Compactop  
e gambe in legno di faggio.



# Woody

Favaretto & Partners Design



Wooden Frame Color / Colore Struttura Legno



Top Color / Colore Piano



Fullcolor

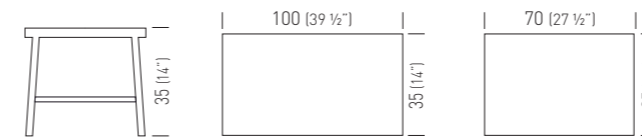

Waiting areas and Coffee Table,  
double Compactop deck and beech legs.  
Tavolino attesa con doppio piano Compactop  
e gambe in legno di faggio.



# Saturno

Studio Eurolinea Design



Compactop with painted aluminum frame.  
Tavolo con piano Compactop e struttura in alluminio verniciato.

Base Color / Colore Base



Top Color / Colore Piano



Special Finishes / Finiture Speciali

**Compactop:** Special Compactop Surfaces Fullcolor (p. 163) available on demand (min. 5pcs each code).  
Special Compactop Surfaces Fullcolor (p. 163) disponibile su richiesta (min. 5pcs per codice).  
Special Compactop Surfaces 10 (p. 164) available on demand (min. 20pcs each code).  
Special Compactop Surfaces 10 (p. 164) disponibile su richiesta (min. 20pcs per codice).

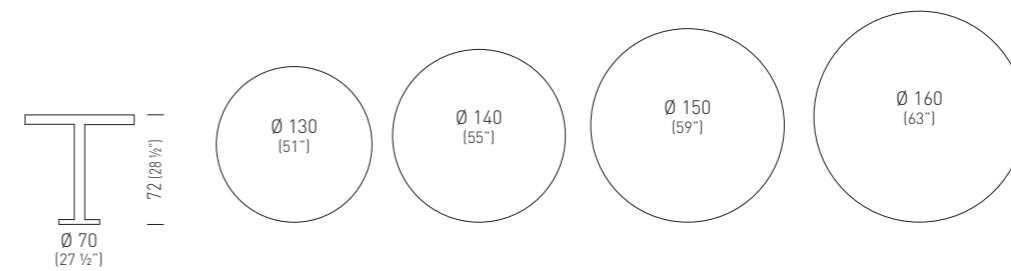
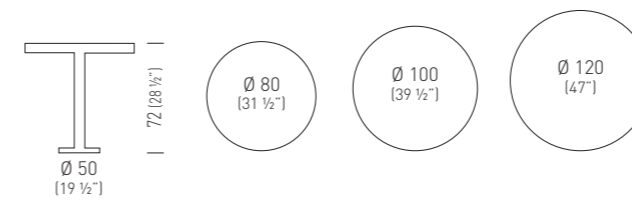



# Saturnino

Studio Eurolinea Design



Base Color / Colore Base

00

Top Color / Colore Piano

00

Fullcolor

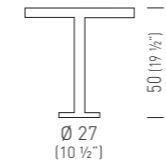

50 (19 1/2")

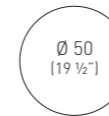

Waiting areas and Coffee Table,  
Compactop with painted aluminum frame.  
Tavolino attesa con piano Compactop  
e struttura in alluminio verniciato.

# Tag

Ilaria Marelli Design



Tag is a table collection suitable for waiting areas, with an elegant and refined style. Available with round or rectangular Marble or Porcelain tops, Tag utilizes a 4 legged aluminum frame.

Tag è una collezione di tavoli adatta alle aree attesa, dallo stile elegante e raffinato. Disponibile con piani rotondi o rettangolari in Marmo o Porcellana, Tag utilizza una struttura a 4 gambe in alluminio.





# Tag Marble

Ilaria Marelli Design

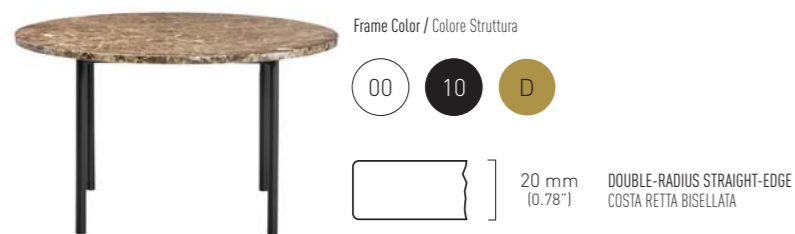

Frame Color / Colore Struttura



20 mm (0.78")  
DOUBLE-RADIUS STRAIGHT-EDGE  
COSTA RETTA BISELLATA

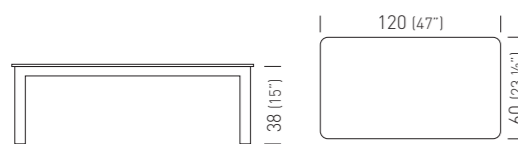
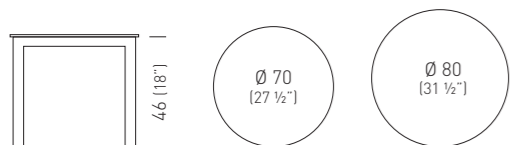
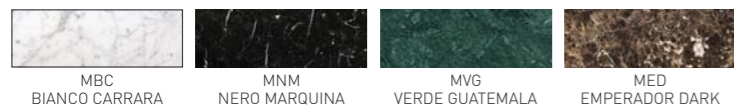

Tag is a table Collection suitable for waiting areas, with an elegant and refined style. Tag utilizes a 4 legged aluminium frame, available in vibrant colours. The Marble tops, characterized by always different veins of natural stones, contribute to enhance elegance and refinement for the most demanding environments. The solid Marble surfaces, shiny and glossy, are treated to reduce their porosity, however constant care and cleaning of the product is recommended. Tag è una collezione di tavoli adatta alle aree attese, dallo stile elegante e raffinato. Tag utilizza una struttura a 4 gambe in alluminio, disponibile in vivaci colori. I piani in Marmo, caratterizzati dalle sempre diverse venature della pietra naturale, offrono eleganza e raffinatezza, per completare con esclusività gli ambienti più ricercati. I solidi piani in Marmo, splendidi e lucidi, sono trattati per ridurre la porosità, tuttavia si consiglia pulizia costante e cura nell'utilizzo del prodotto.

# Tag Porcelain

Ilaria Marelli Design



Frame Color / Colore Struttura



13 mm (0.51")  
CHAMFERED EDGE  
BORDO SMUSSATO

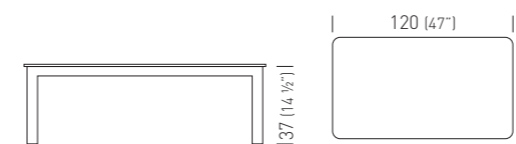
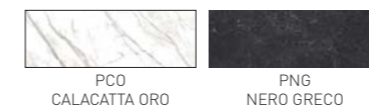

Tag is a table Collection suitable for waiting areas, with an elegant and refined style. Tag utilizes a 4 legged aluminium frame, available in vibrant colours. The Porcelain stoneware tops stand out for their excellent technical performance, ideal for the most delicate uses where maximum hygiene and resistance must be guaranteed. Porcelain tops are compatible with foodstuffs, resistant to fungi and molds, suitable for both indoor and outdoor use, resistant to frost, heat and high temperatures, they can be cleaned very easily while maintaining the characteristics of the surface.

Tag è una collezione di tavoli adatta alle aree attese, dallo stile elegante e raffinato. Tag utilizza una struttura a 4 gambe in alluminio, disponibile in vivaci colori. I piani in Gres Porcellanato si distinguono per le eccellenti performance tecniche, ideali negli impieghi più delicati nei quali è necessario garantire la massima igiene e resistenza. I piani Porcelain sono compatibili con le sostanze alimentari, resistenti a funghi e muffe, idonei ad un utilizzo sia interno che esterno, resistenti al gelo, al calore e alle alte temperature, si possono pulire con estrema facilità mantenendo inalterate le caratteristiche della superficie.

# Link

Stefano Sandonà Design



Frame Color / Colore Struttura

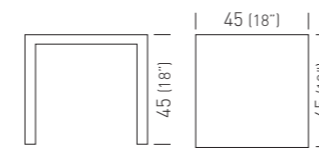

Waiting areas and Coffee Table,  
painted metal structure suitable for outdoor purpose.  
Tavolino attesa, struttura in metallo  
verniciato per utilizzo esterno.



# Minush

Studio Eurolinea Design



Technopolymer Frame Color / Colore Struttura Tecnopolimero

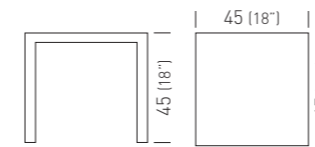

The Minush stackable coffee table, made of technopolymer, takes up the lines of some collections of Gaber chairs and sunbeds, but suit perfectly any outdoor seat as a practical support for small objects.

Il tavolino impilabile Minush, realizzato in tecnopolimero, riprende le linee di alcune collezioni di sedute e lettini Gaber, ma ben si adatta ad accompagnare qualunque seduta da esterno come pratico appoggio per piccoli oggetti.



# Aprio

Forsix Design



Aprio is an extendable rectangular garden table, with an epoxy powder coated aluminum frame and compact laminate top. Thanks to the construction materials and the telescopic extending frame, integrated with the legs, the table lends itself perfectly to both indoor and outdoor use. The patented extension system allows the structure to slide, keeping the legs always at the ends of the table. A quick coupling system allows easy extension by inserting one or two of the leaves that are hidden within the frame itself.

Aprio è un tavolo da giardino rettangolare allungabile, con struttura in alluminio verniciato a polveri epossidiche e piano in Compactop. Grazie ai materiali di costruzione e alla struttura telescopica di allungo, solidale con la gamba, il tavolo si presta perfettamente all'utilizzo sia indoor che outdoor. Il sistema brevettato di allungo consente lo scorrimento della struttura, mantenendo le gambe sempre alle estremità del tavolo. E' possibile scegliere di allungare il tavolo aggiungendo con facilità una o due prolunghe, completamente nascoste all'interno della struttura, grazie ad un sistema di aggancio rapido.





Frame Color / Colore Struttura



Compactop Color / Colore Piano Compactop

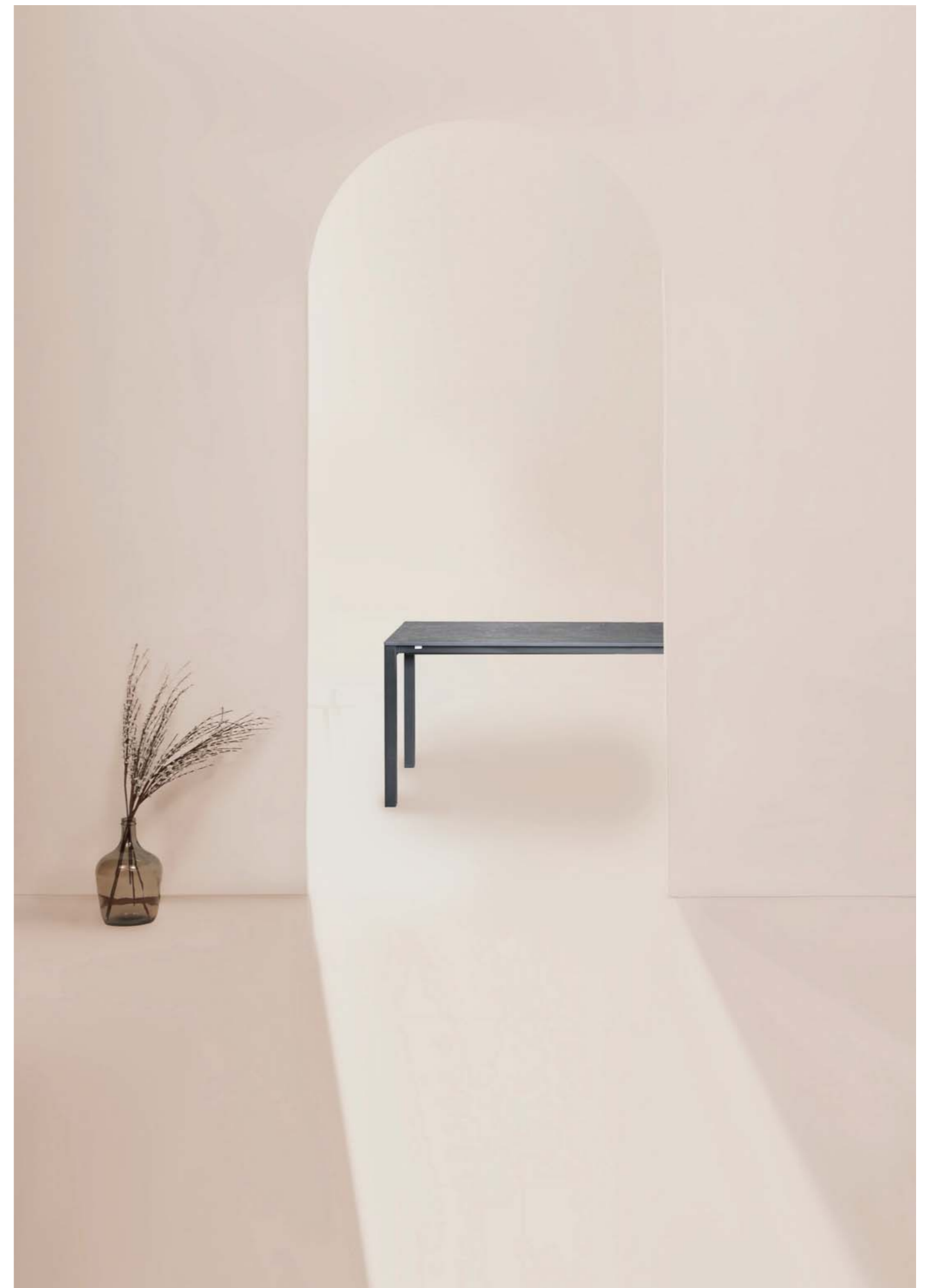
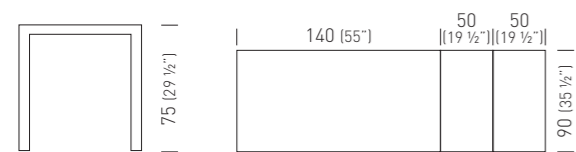

# Claro

Studio Eurolinea Design



Only for compactop  
solo per compactop

Frame Color / Colore Struttura



Compactop Color / Colore Piano Compactop



Laminated Top Color / Colore Piano Laminato



Special Finishes / Finiture Speciali

**Compactop** Special Compactop Surfaces 10 (p. 164) available on demand (min. 20pcs each code).  
Special Compactop Surfaces 10 (p. 164) disponibile su richiesta (min. 20pcs per codice).  
**Laminated:** Special Laminated Surfaces Wood Effect 25 (p. 169) available on demand (min. 20pcs each code).  
Special Laminated Surfaces Wood Effect 25 (p. 169) disponibile su richiesta (min. 20pcs per codice).  
Special Laminated Surfaces Fenix 25 (p. 170) available on demand (min. 20pcs each code).  
Special Laminated Surfaces Fenix 25 (p. 170) disponibile su richiesta (min. 20pcs per codice).

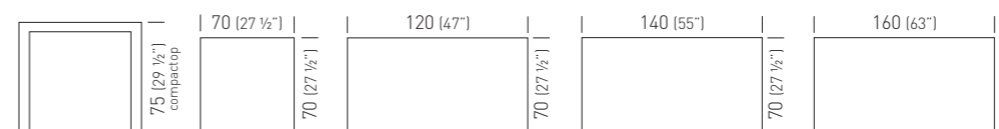
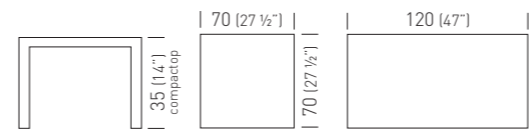

Table with co-injected metal frame with techno polymer, Compactop or laminated top. Suitable for outdoor purpose with Compactop. Tavolo con struttura in metallo sovrastampato con tecnopolimero, piano in Compactop o laminato. Con piano Compactop, adatto anche all'uso esterno.





# Claro



Only for compactop  
solo per compactop



Frame Color / Colore Struttura



Compactop Color / Colore Piano Compactop



Laminated Top Color / Colore Piano Laminato



Special Finishes / Finiture Speciali

**Compactop** Special Compactop Surfaces 10 (p. 164) available on demand (min. 20pcs each code).  
Special Compactop Surfaces 10 (p. 164) disponibile su richiesta (min. 20pcs per codice).  
**Laminated:** Special Laminated Surfaces Wood Effect 25 (p. 169) available on demand (min. 20pcs each code).  
Special Laminated Surfaces Wood Effect 25 (p. 169) disponibile su richiesta (min. 20pcs per codice).  
Special Laminated Surfaces Fenix 25 (p. 170) available on demand (min. 20pcs each code).  
Special Laminated Surfaces Fenix 25 (p. 170) disponibile su richiesta (min. 20pcs per codice).

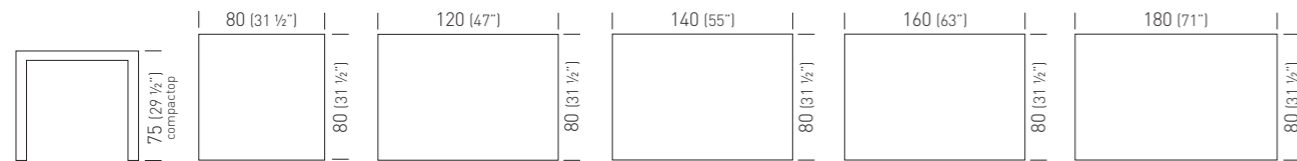

Only for compactop  
solo per compactop

Frame Color / Colore Struttura



Compactop Color / Colore Piano Compactop



Laminated Top Color / Colore Piano Laminato



Special Finishes / Finiture Speciali

**Compactop** Special Compactop Surfaces 10 (p. 164) available on demand (min. 20pcs each code).  
Special Compactop Surfaces 10 (p. 164) disponibile su richiesta (min. 20pcs per codice).  
**Laminated:** Special Laminated Surfaces Wood Effect 25 (p. 169) available on demand (min. 20pcs each code).  
Special Laminated Surfaces Wood Effect 25 (p. 169) disponibile su richiesta (min. 20pcs per codice).  
Special Laminated Surfaces Fenix 25 (p. 170) available on demand (min. 20pcs each code).  
Special Laminated Surfaces Fenix 25 (p. 170) disponibile su richiesta (min. 20pcs per codice).

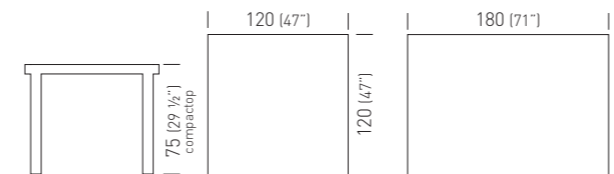
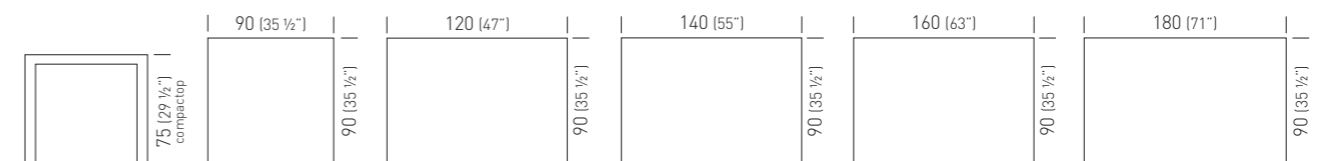

# Claro Slim

Studio Eurolinea Design



Only for Compactop  
Solo per Compactop

Frame Color / Colore Struttura



Compactop Color / Colore Piano Compactop



Laminated Top Color / Colore Piano Laminato



Special Finishes / Finiture Speciali

**Compactop:** Special Compactop Surfaces 10 (p.164) available on demand (min. 20pcs each code)  
Special Compactop Surfaces 10 (p. 164) disponibile su richiesta (min. 20pcs per codice).  
**Laminated:** Special Laminated Surfaces Wood Effect 25 (p. 169) available on demand (min. 20pcs each code)  
Special Laminated Surfaces Wood Effect 25 (p. 169) disponibile su richiesta (min. 20pcs per codice)  
Special Laminated Surfaces Fenix 25 (p. 170) available on demand (min. 20pcs each code)  
Special Laminated Surfaces Fenix 25 (p. 170) disponibile su richiesta (min. 20pcs per codice)

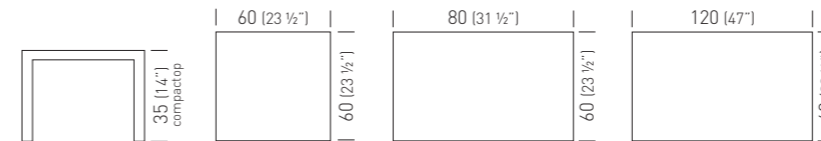



# Claro Slim



Only for Compactop  
Solo per Compactop



Only for Compactop  
Solo per Compactop

High table, Compactop or Laminated table top, painted metal frame.  
Tavolo alto con struttura in metallo verniciato, piano in Compactop o Laminato.

Frame Color / Colore Struttura



Compactop Color / Colore Piano Compactop



Laminated Top Color / Colore Piano Laminato



Special Finishes / Finiture Speciali

**Compactop:** Special Compactop Surfaces 10 (p.164) available on demand (min. 20pcs each code)  
Special Compactop Surfaces 10 (p. 164) disponibile su richiesta (min. 20pcs per codice).  
**Laminated:** Special Laminated Surfaces Wood Effect 25 (p. 169) available on demand (min. 20pcs each code)  
Special Laminated Surfaces Wood Effect 25 (p. 169) disponibile su richiesta (min. 20pcs per codice)  
Special Laminated Surfaces Fenix 25 (p. 170) available on demand (min. 20pcs each code)  
Special Laminated Surfaces Fenix 25 (p. 170) disponibile su richiesta (min. 20pcs per codice)

Frame Color / Colore Struttura



Compactop Color / Colore Piano Compactop



Laminated Top Color / Colore Piano Laminato



Special Finishes / Finiture Speciali

**Compactop:** Special Compactop Surfaces 10 (p.164) available on demand (min. 20pcs each code)  
Special Compactop Surfaces 10 (p. 164) disponibile su richiesta (min. 20pcs per codice).  
**Laminated:** Special Laminated Surfaces Wood Effect 25 (p. 169) available on demand (min. 20pcs each code)  
Special Laminated Surfaces Wood Effect 25 (p. 169) disponibile su richiesta (min. 20pcs per codice)  
Special Laminated Surfaces Fenix 25 (p. 170) available on demand (min. 20pcs each code)  
Special Laminated Surfaces Fenix 25 (p. 170) disponibile su richiesta (min. 20pcs per codice)

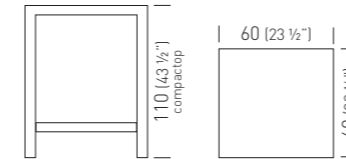
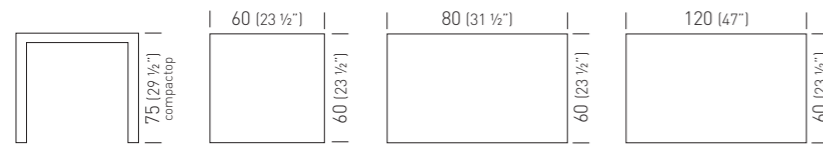

# Space

Studio Eurolinea Design



Frame Color / Colore Struttura



Compactop Color / Colore Piano Compactop

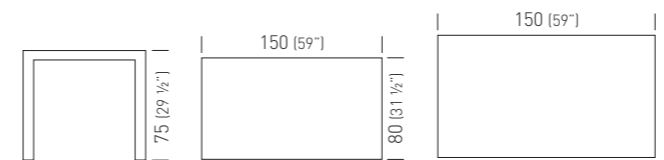
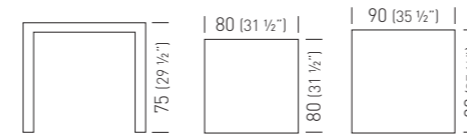

Innovative and durable, the Space table is characterized by a thin Compactop profile and a solid four-legged structure in anodized aluminum. Resistant to stains, abrasions and thermal variations, the table can also be used for intensive use. Innovativo e durevole, il tavolo Space è caratterizzato da un piano in Compactop dal profilo sottile e da una solida struttura a quattro gambe in alluminio anodizzato. Resistente alle macchie, alle abrasioni e alle variazioni termiche, il tavolo può essere utilizzato anche per utilizzi intensivi.



# Profilo

Studio Eurolinea Design



Compactop or Laminated table top with painted metal frame. Adjustable feet.  
Tavolo con struttura in metallo verniciato, piano in Compactop o Laminato. Piedini regolabili

Frame Color / Colore Struttura



Compactop Color / Colore Piano Compactop



Laminated Top Color / Colore Piano Laminato



Special Finishes / Finiture Speciali

**Compactop:** Special Compactop Surfaces Fullcolor (p. 163) available on demand (min. 5pcs each code).  
Special Compactop Surfaces Fullcolor (p. 163) disponibile su richiesta (min. 5pcs per codice).  
Special Compactop Surfaces 10 (p. 164) available on demand (min. 20pcs each code).  
Special Compactop Surfaces 10 (p. 164) disponibile su richiesta (min. 20pcs per codice).  
**Laminated:** Special Laminated Surfaces Wood Effect 25 (p. 169) available on demand (min. 20pcs each code).  
Special Laminated Surfaces Wood Effect 25 (p.169) disponibile su richiesta (min. 20pcs per codice).  
Special Laminated Surfaces Fenix 25 (p. 170) available on demand (min. 20pcs each code).  
Special Laminated Surfaces Fenix 25 (p.170) disponibile su richiesta (min. 20pcs per codice).

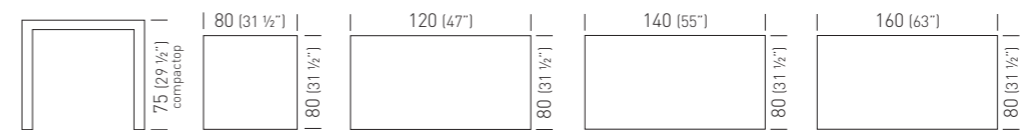



# Banket

Studio Eurolinea Design

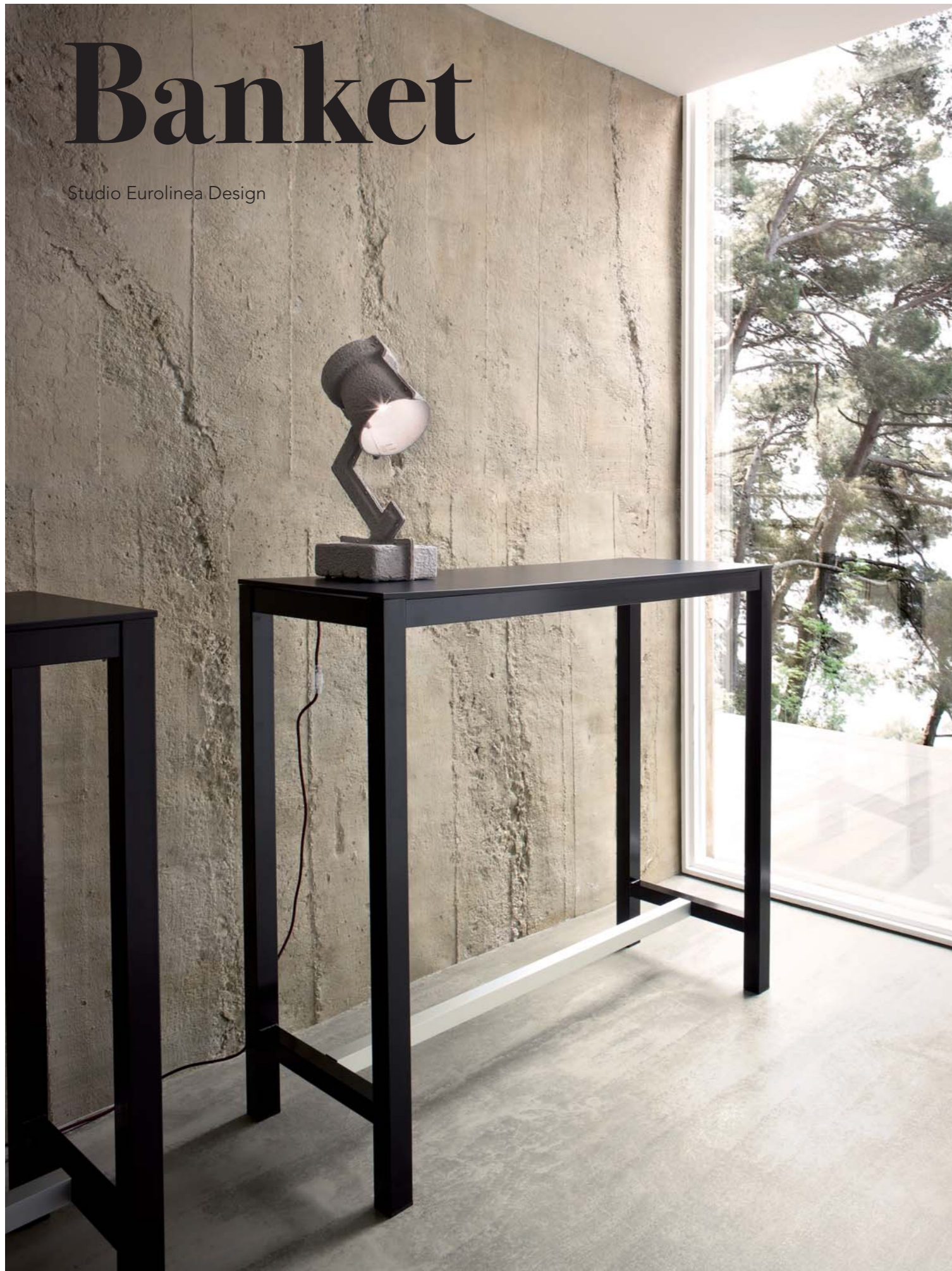

Only for Compactop  
Solo per Compactop

Frame Color / Colore Struttura



Compactop Color / Colore Piano Compactop



Laminated Top Color / Colore Piano Laminato



Special Finishes / Finiture Speciali

**Compactop:** Special Compactop Surfaces Fullcolor (p. 163) available on demand (min. 5pcs each code).  
Special Compactop Surfaces Fullcolor (p. 163) disponibile su richiesta (min. 5pcs per codice).  
Special Compactop Surfaces 10 (p. 164) available on demand (min. 20pcs each code).  
Special Compactop Surfaces 10 (p. 164) disponibile su richiesta (min. 20pcs per codice).  
**Laminated:** Special Laminated Surfaces Wood Effect 25 (p. 169) available on demand (min. 20pcs each code).  
Special Laminated Surfaces Wood Effect 25 (p. 169) disponibile su richiesta (min. 20pcs per codice).  
Special Laminated Surfaces Fenix 25 (p. 170) available on demand (min. 20pcs each code).  
Special Laminated Surfaces Fenix 25 (p. 170) disponibile su richiesta (min. 20pcs per codice).

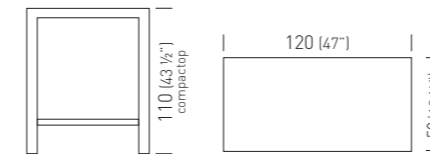



# Step

Studio Eurolinea Design



Technopolymer Frame Color / Colore Struttura Tecnopolimero



Compactop Color / Colore Piano Compactop



Special Finishes / Finiture Speciali

**Compactop:** Special Compactop Surfaces 10 (p. 164) available on demand (min. 20pcs each code).  
Special Compactop Surfaces 10 (p. 164) disponibile su richiesta (min. 20pcs per codice).

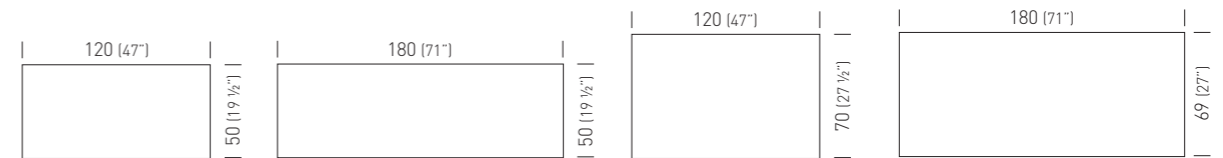

High table, co-injected metal frame with techno polymer, Compactop. Suitable for outdoor purpose. Tavolo alto con struttura in metallo sovrastampato con tecnopolimero, piano in Compactop. Adatto anche all'uso esterno.





# Ics

Studio Eurolinea Design

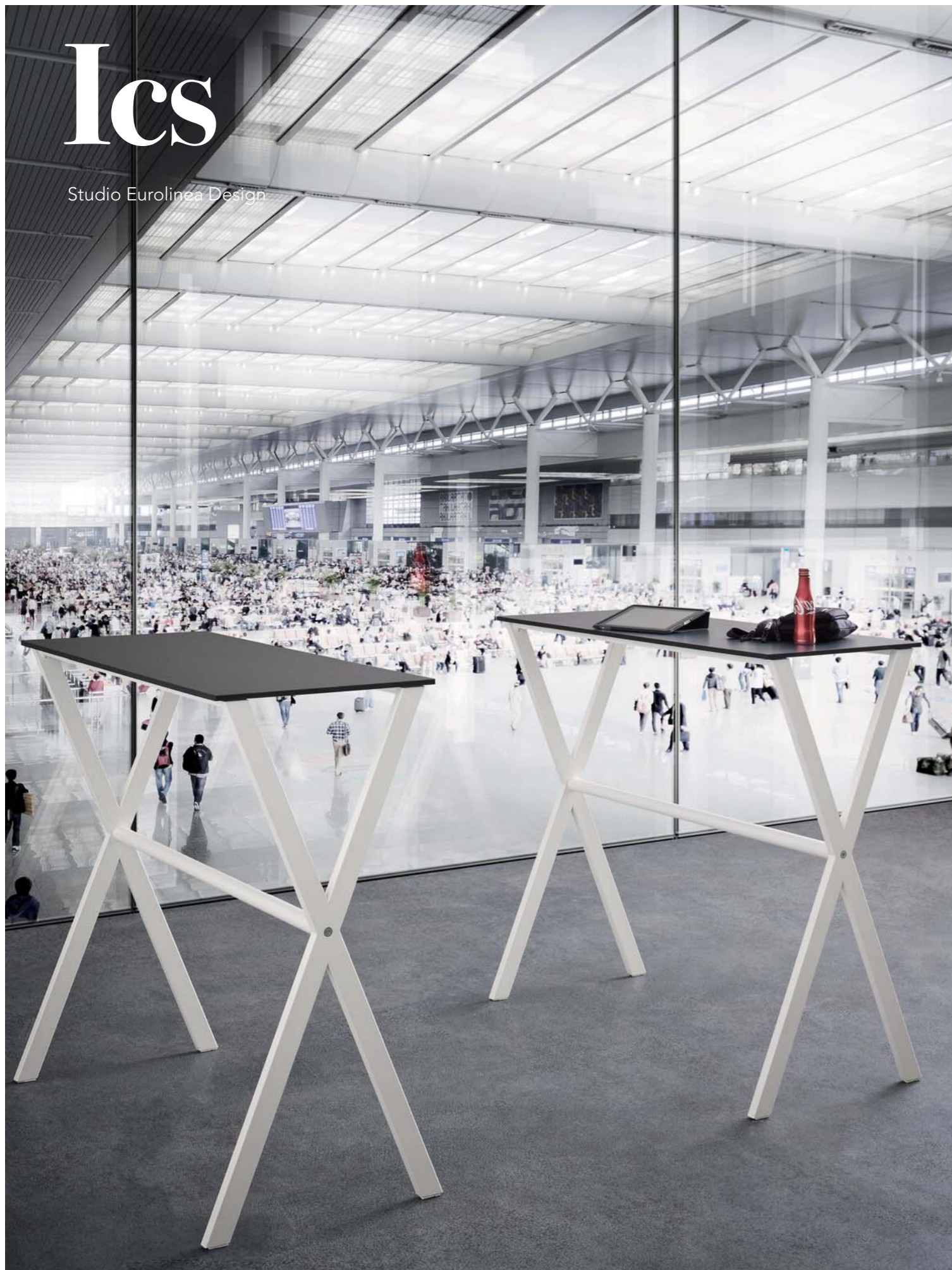

Frame Color / Colore Struttura



Compactop Color / Colore Piano Compactop



Laminated Top Color / Colore Piano Laminato



Special Finishes / Finiture Speciali

**Compactop:** Special Compactop Surfaces Fullcolor (p. 163) available on demand (min. 5pcs each code).  
Special Compactop Surfaces Fullcolor (p. 163) disponibile su richiesta (min. 5pcs per codice).  
Special Compactop Surfaces 10 (p. 164) available on demand (min. 20pcs each code).  
Special Compactop Surfaces 10 (p. 164) disponibile su richiesta (min. 20pcs per codice).  
**Laminated:** Special Laminated Surfaces Wood Effect 25 (p. 169) available on demand (min. 20pcs each code).  
Special Laminated Surfaces Wood Effect 25 (p. 169) disponibile su richiesta (min. 20pcs per codice).  
Special Laminated Surfaces Fenix 25 (p. 170) available on demand (min. 20pcs each code).  
Special Laminated Surfaces Fenix 25 (p. 170) disponibile su richiesta (min. 20pcs per codice).

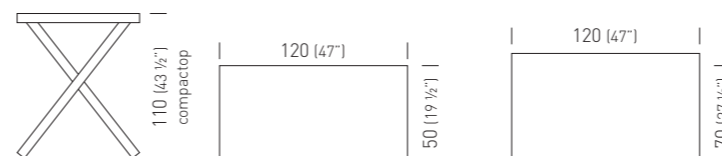



# Format

Studio Eurolinea Design



Table with metal painted frame and Compactop table top.  
Suitable for outdoor purpose. Adjustable feet.  
Tavolo con struttura in metallo verniciato, piano in Compactop.  
Adatto anche all'uso esterno. Piedini regolabili.



Frame Color / Colore Struttura



Compactop Color / Colore Piano Compactop



Special Finishes / Finiture Speciali

**Compactop:** Special Compactop Surfaces Fullcolor (p. 163) available on demand (min. 5pcs each code).  
Special Compactop Surfaces Fullcolor (p. 163) disponibile su richiesta (min. 5pcs per codice).  
Special Compactop Surfaces 10 (p. 164) available on demand (min. 20pcs each code).  
Special Compactop Surfaces 10 (p. 164) disponibile su richiesta (min. 20pcs per codice).

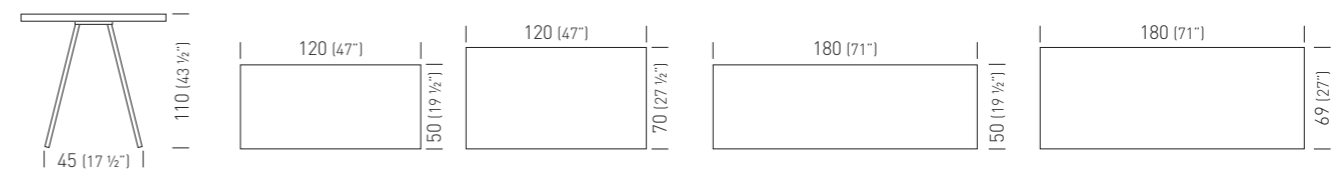
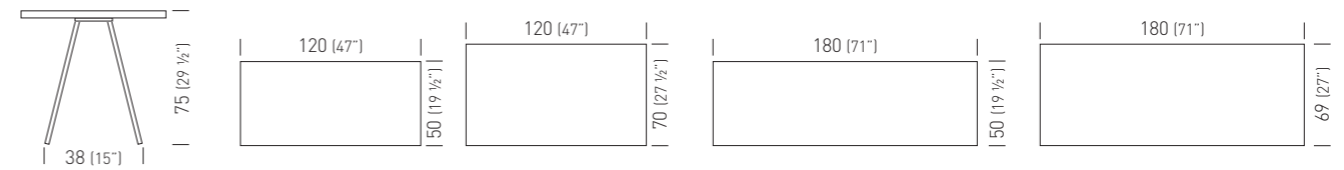



# Simply

Studio Eurolinea Design



Only Iron Top  
Solo Iron top

Frame Color / Colore Struttura



Iron Top Color / Colore Piano Iron

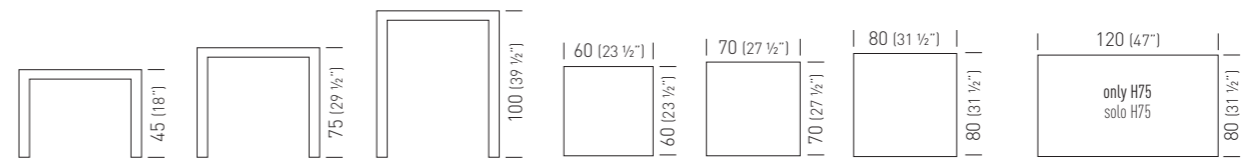

Frame Color / Colore Struttura



Laminated Top Color / Colore Piano Laminato



Special Finishes / Finiture Speciali

**Laminated:** Special Laminated Surfaces Wood Effect 25 (p. 169) available on demand (min. 20pcs each code).  
Special Laminated Surfaces Wood Effect 25 (p.169) disponibile su richiesta (min. 20pcs per codice).  
Special Laminated Surfaces Fenix 25 (p. 170) available on demand (min. 20pcs each code).  
Special Laminated Surfaces Fenix 25 (p.170) disponibile su richiesta (min. 20pcs per codice).

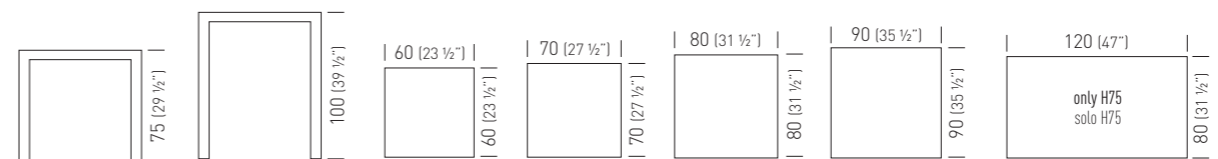



# Hug

Studio Eurolinea Design



 Only Steel and Compactop  
Solo piani Acciaio e Compactop

Frame Color / Colore Struttura



Compactop Color / Colore Piano Compactop



Laminated Top Color / Colore Piano Laminato



Steel Top Color / Colore Piano Acciaio



Special Finishes / Finiture Speciali

**Compactop:** Special Compactop Surfaces Fullcolor (p. 163) available on demand (min. 5pcs each code).  
Special Compactop Surfaces Fullcolor (p. 163) disponibile su richiesta (min. 5pcs per codice).  
Special Compactop Surfaces Fenix (p. 166) available on demand (min. 20pcs each code).  
Special Compactop Surfaces Fenix (p. 166) disponibile su richiesta (min. 20pcs per codice).  
Special Compactop Surfaces 10 (p. 164) available on demand (min. 20pcs each code).  
Special Compactop Surfaces 10 (p. 164) disponibile su richiesta (min. 20pcs per codice).  
**Laminated:** Special Laminated Surfaces Wood Effect (p. 169) available on demand (min. 20pcs each code).  
Special Laminated Surfaces Wood Effect (p. 169) disponibile su richiesta (min. 20pcs per codice).  
Special Laminated Surfaces Fenix (p. 170) available on demand (min. 20pcs each code).  
Special Laminated Surfaces Fenix (p. 170) disponibile su richiesta (min. 20pcs per codice).

Compactop

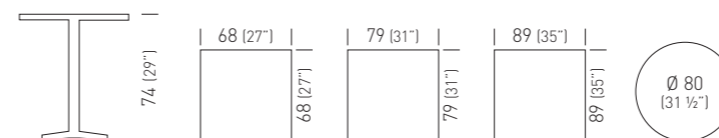

Steel

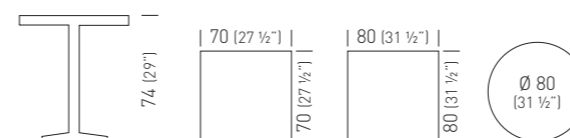

Laminated

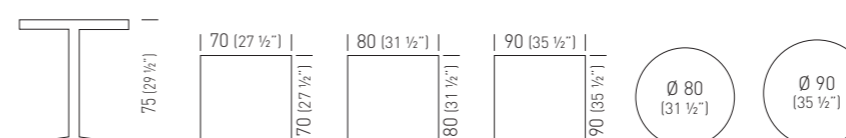

# Hug Marble

Studio Eurolinea Design



Frame Color / Colore Struttura



20 mm (0.78")  
DOUBLE-RADIUS STRAIGHT-EDGE  
COSTA RETTA BISELLATA

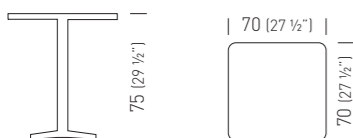

The Hug tables collection, made with a 4-star aluminum base, equipped with adjustable feet, is enriched with new Marble tops, thus adapting to the most prestigious installations.

The Marble tops, characterized by always different veins of natural stones, contribute to enhance elegance and refinement for the most demanding environments. The solid Marble surfaces, shiny and glossy, are treated to reduce their porosity, however constant care and cleaning of the product is recommended.

La collezione di tavoli Hug, realizzata con basamento 4 raze in alluminio, dotata di piedini regolabili, si arricchisce di nuovi piani quadrati in Marmo, adattandosi così alle installazioni più prestigiose. I piani in Marmo, caratterizzati dalle sempre diverse venature della pietra naturale, offrono eleganza e raffinatezza, per completare con esclusività gli ambienti più ricercati. I solidi piani in Marmo, splendenti e lucidi, sono trattati per ridurre la porosità, tuttavia si consiglia pulizia costante e cura nell'utilizzo del prodotto.

# Hug Porcelain

Studio Eurolinea Design



Frame Color / Colore Struttura



13 mm (0.51")  
CHAMFERED EDGE  
BORDO SMUSSATO

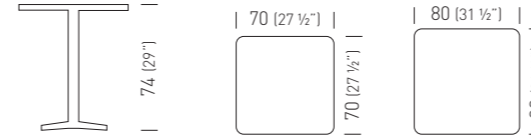
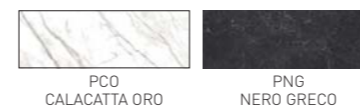

The Hug tables collection, made with a 4-star aluminum base, equipped with adjustable feet, is enriched with new Porcelain tops, thus adapting to the most prestigious installations.

The Porcelain stoneware tops stand out for their excellent technical performance, ideal for the most delicate uses where maximum hygiene and resistance must be guaranteed. Porcelain tops are compatible with foodstuffs, resistant to fungi and molds, suitable for both indoor and outdoor use, resistant to frost, heat and high temperatures, they can be cleaned very easily while maintaining the characteristics of the surface.



La collezione di tavoli Hug, realizzata con basamento 4 raze in alluminio, dotata di piedini regolabili, si arricchisce di nuovi piani quadrati in Gres Porcellanato, adattandosi così alle installazioni più prestigiose. I piani in Gres Porcellanato si distinguono per le eccellenti performance tecniche, ideali negli impieghi più delicati nei quali è necessario garantire la massima igiene e resistenza. I piani Porcelain sono compatibili con le sostanze alimentari, resistenti a funghi e muffe, idonei ad un utilizzo sia interno che esterno, resistenti al gelo, al calore a alle alte temperature, si possono pulire con estrema facilità mantenendo inalterate le caratteristiche della superficie.



# Mug

Studio Eurolinea Design



CE    
 230V - 50Hz  
 1 X 16W - Led Modul  
 IP 65



Technopolymer Base Color / Colore Base Tecnopolimero



Compactop Color / Colore Piano Compactop



Special Finishes / Finiture Speciali

**Compactop:** Special Compactop Surfaces Fullcolor (p.163) white available on demand (min. 5pcs each code).  
 Special Compactop Surfaces Fullcolor (p.163) bianco disponibile su richiesta (min. 5pcs per codice).

Led version with white transparent base.  
 Versione led con base in bianco trasparente.

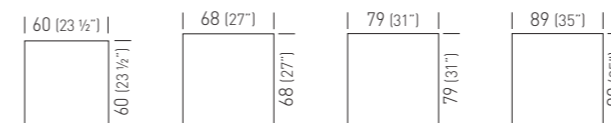
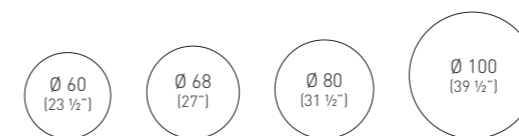
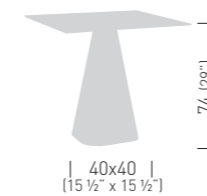

H75 Table with Compactop, Technopolymer base.  
 Available illuminated and suitable for outdoor use.  
 Tavolo realizzato con piano in Compactop H75  
 e struttura in tecnopolimero.  
 Disponibile con versione luminosa e adatti all'uso esterno.





# Roller

Studio Eurolinea Design



Tables, chairs, benches and stools Collection.  
 Compactop with technopolymer bases.  
 Available illuminated and suitable for outdoor use.  
 Collezione di tavoli, sedute, panche e sgabelli.  
 I tavoli sono realizzati con piano Compactop  
 e struttura in tecnopolimero.  
 Disponibili con versione luminosa  
 e adatti anche all'uso esterno.



Technopolymer Base Color / Colore Base Tecnopolimero



Compactop Color / Colore Piano Compactop



Special Finishes / Finiture Speciali

**Compactop:** Special Compactop Surfaces Fullcolor (p.163) white available on demand (min. 5pcs each code).  
 Special Compactop Surfaces Fullcolor (p.163) bianco disponibile su richiesta (min. 5pcs per codice).

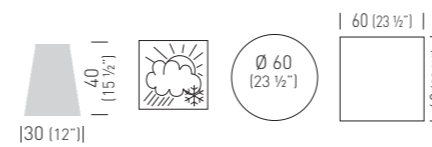

Technopolymer Base Color / Colore Base Tecnopolimero

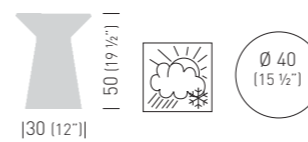



# Roller

# R



CE   
 230V – 50Hz   
 1 X 16W – Led Modul   
 IP 65

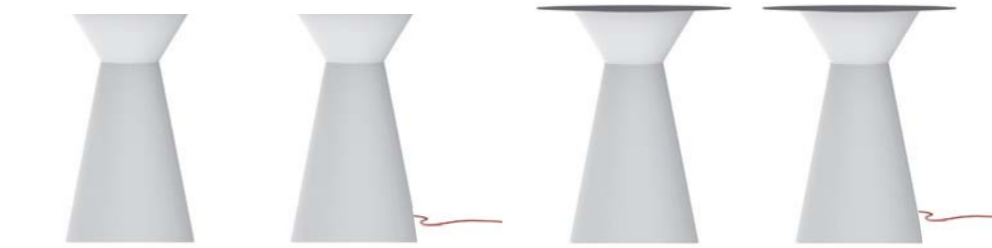

CE   
 230V – 50Hz   
 1 X 16W – Led Modul   
 IP 65

**Technopolymer Base Color / Colore Base Tecnopolimero**

56 (22")  
40 (15 1/2")

00 10 13 14

Led version with white transparent base.  
Versione led con base in bianco trasparente.

**Compactop Color / Colore Piano Compactop**

00 10 14

**Special Finishes / Finiture Speciali**

**Compactop:** Special Compactop Surfaces Fullcolor (p.163) white available on demand (min. 5pcs each code).  
 Special Compactop Surfaces Fullcolor (p.163) bianco disponibile su richiesta (min. 5pcs per codice).

**Technopolymer Base Color / Colore Base Tecnopolimero**

74 (29")  
40 (15 1/2")

00 10 13 14

Led version with white transparent base.  
Versione led con base in bianco trasparente.

**Compactop Color / Colore Piano Compactop**

00 10 14

**Special Finishes / Finiture Speciali**

**Compactop:** Special Compactop Surfaces Fullcolor (p.163) white available on demand (min. 5pcs each code).  
 Special Compactop Surfaces Fullcolor (p.163) bianco disponibile su richiesta (min. 5pcs per codice).

Ø 60 (23 1/2")    Ø 68 (27")

60 (23 1/2")    68 (27")



Ø 60 (23 1/2")    Ø 68 (27")    Ø 80 (31 1/2")    Ø 100 (39 1/2")

60 (23 1/2")    68 (27")    79 (31")    89 (35")

# Roller

# R



CE    
 230V - 50Hz  
 1 X 16W - Led Modul  
 IP 65

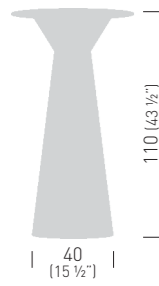

Technopolymer Base Color / Colore Base Tecnopolimero



Compactop Color / Colore Piano Compactop





Special Finishes / Finiture Speciali

**Compactop:** Special Compactop Surfaces Fullcolor (p.163) white available on demand (min. 5pcs each code).  
 Special Compactop Surfaces Fullcolor (p.163) bianco disponibile su richiesta (min. 5pcs per codice).

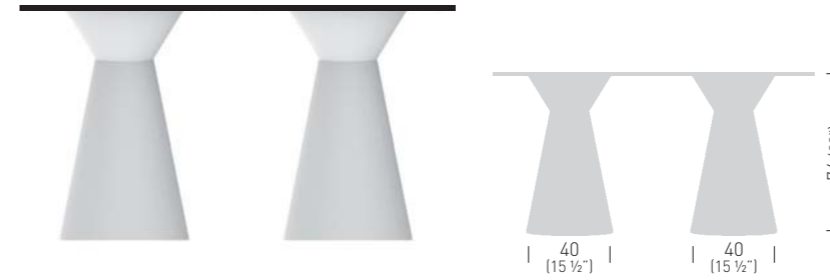
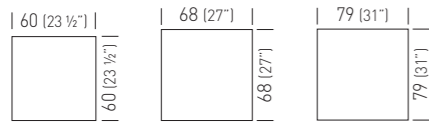
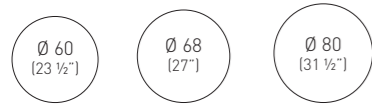
Led version with white transparent base.  
 Versione led con base in bianco trasparente.



CE    
 230V - 50Hz  
 1 X 16W - Led Modul  
 IP 65

Technopolymer Base Color / Colore Base Tecnopolimero



Compactop Color / Colore Piano Compactop



Special Finishes / Finiture Speciali

**Compactop:** Special Compactop Surfaces Fullcolor (p.163) white available on demand (min. 5pcs each code).  
 Special Compactop Surfaces Fullcolor (p.163) bianco disponibile su richiesta (min. 5pcs per codice).

Led version with white transparent base.  
 Versione led con base in bianco trasparente.

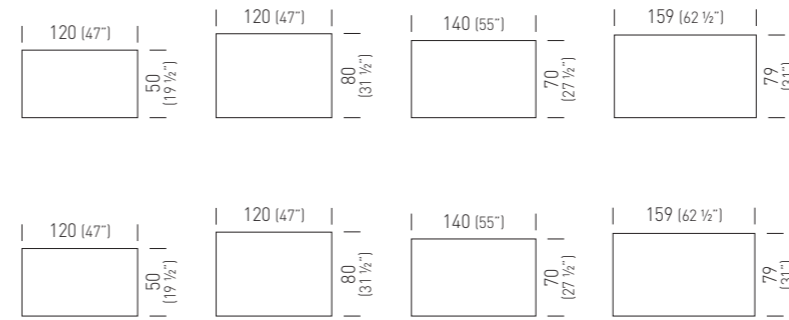



TKITT is a table collection, suitable for outdoor use. Tables are made with techno polymer tops in different shapes and sizes, combined with technopolymer-metal co-injected bases and anodized columns.

Technopolymer table top colors match perfectly the colors of the Gaber seating collection.

TKITT è una collezione di tavoli adatti anche all'uso esterno. I tavoli sono realizzati con piani in tecnopolimero di varie dimensioni e forme, combinati a basamenti in metallo sovrastampato con tecnopolimero e colonne in alluminio anodizzato. I colori dei piani dei tavoli corrispondono ai colori della vasta collezione di sedute Gaber.

## TKITT Collection

TABLES FOR INDOOR AND OUT



# TKITT.BG3K

H75 Table with technopolymer top, BG3K 3-spur metal-technopolymer co-injected table base, Ø 80mm anodized aluminum column.

Tavolo con piano in tecnopolimero H75, basamento BG3K a tre razze in metallo sovrastampato con tecnopolimero, colonna in alluminio anodizzato Ø 80mm.

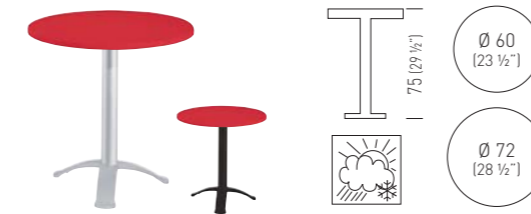

■ TKITT04.\_/BG3K 0.13m³ / 13.8kg / 1pcs  
 ■ TKITT04.\_/BG3K.10 0.13m³ / 13.8kg / 1pcs

■ TKITT03.\_/BG3K 0.15m³ / 14.5kg / 1pcs  
 ■ TKITT03.\_/BG3K.10 0.15m³ / 14.5kg / 1pcs



■ TKITT20.\_/BG3K 0.13m³ / 14.6kg / 1pcs  
 ■ TKITT20.\_/BG3K.10 0.13m³ / 14.6kg / 1pcs

■ TKITT06.\_/BG3K 0.15m³ / 15.8kg / 1pcs  
 ■ TKITT06.\_/BG3K.10 0.15m³ / 15.8kg / 1pcs

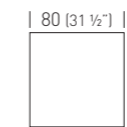

■ TKITT23.\_/BG3K 0.16m³ / 18.4kg / 1pcs  
 ■ TKITT23.\_/BG3K.10 0.16m³ / 18.4kg / 1pcs

Top Color / Colore Piano







## TKITT.BG3L

H75 Table with technopolymer top, BG3L 3-spur metal-technopolymer co-injected table base, Ø 80mm anodized aluminum column.

Tavolo con piano in tecnopolimero H75, basamento BG3L a tre razze in metallo sovrastampato con tecnopolimero, colonna in alluminio anodizzato Ø 80mm.

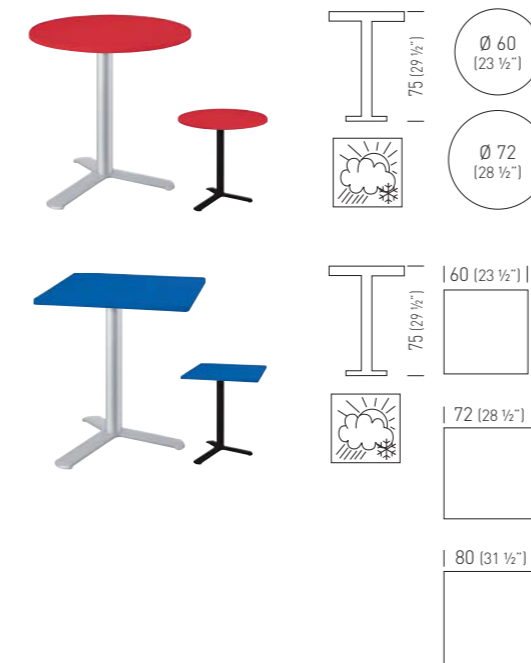

■ TKITT04.\_/BG3L 0.14m³ / 15kg / 1pcs  
 ■ TKITT04.\_/BG3L.10 0.14m³ / 15kg / 1pcs

■ TKITT03.\_/BG3L 0.16m³ / 15.7kg / 1pcs  
 ■ TKITT03.\_/BG3L.10 0.16m³ / 15.7kg / 1pcs

■ TKITT20.\_/BG3L 0.14m³ / 15.8kg / 1pcs  
 ■ TKITT20.\_/BG3L.10 0.14m³ / 15.8kg / 1pcs

■ TKITT06.\_/BG3L 0.16m³ / 17kg / 1pcs  
 ■ TKITT06.\_/BG3L.10 0.16m³ / 17kg / 1pcs

■ TKITT23.\_/BG3L 0.17m³ / 19.6kg / 1pcs  
 ■ TKITT23.\_/BG3L.10 0.17m³ / 19.6kg / 1pcs

## TKITT.BGA3L

H110 Table with technopolymer top, BG3L 3-spur metal-technopolymer co-injected table base, Ø 80mm anodized aluminum column.

Tavolo con piano in tecnopolimero H110, basamento BG3L a tre razze in metallo sovrastampato con tecnopolimero, colonna in alluminio anodizzato Ø 80mm.

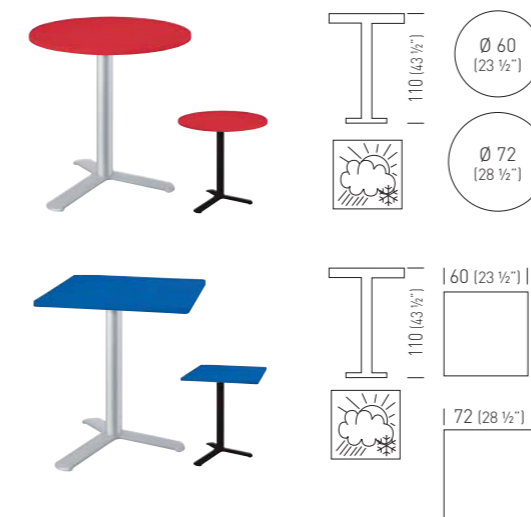

■ TKITT04.\_/BGA3L 0.18m³ / 15.8kg / 1pcs  
 ■ TKITT04.\_/BGA3L.10 0.18m³ / 15.8kg / 1pcs

■ TKITT03.\_/BGA3L 0.20m³ / 16.5kg / 1pcs  
 ■ TKITT03.\_/BGA3L.10 0.20m³ / 16.5kg / 1pcs

■ TKITT20.\_/BGA3L 0.18m³ / 16.6kg / 1pcs  
 ■ TKITT20.\_/BGA3L.10 0.18m³ / 16.6kg / 1pcs

■ TKITT06.\_/BGA3L 0.20m³ / 17.8kg / 1pcs  
 ■ TKITT06.\_/BGA3L.10 0.20m³ / 17.8kg / 1pcs

Top Color / Colore Piano







## TKITT.BG4K

H75 Table with technopolymer top, BG4K 4-spur metal-technopolymer co-injected table base, Ø 80mm anodized aluminum column.

Tavolo con piano in tecnopolimero H75, basamento BG4K a quattro razze in metallo sovrastampato con tecnopolimero, colonna in alluminio anodizzato Ø 80mm.

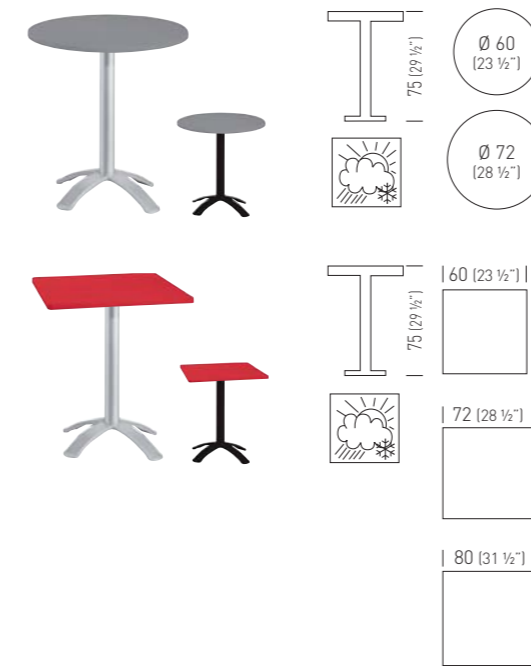

■ TKITT04.\_/BG4K 0.13m³ / 16.5kg / 1pcs  
 ■ TKITT04.\_/BG4K.10 0.13m³ / 16.5kg / 1pcs

■ TKITT03.\_/BG4K 0.15m³ / 17.2kg / 1pcs  
 ■ TKITT03.\_/BG4K.10 0.15m³ / 17.2kg / 1pcs

■ TKITT20.\_/BG4K 0.13m³ / 17.3kg / 1pcs  
 ■ TKITT20.\_/BG4K.10 0.13m³ / 17.3kg / 1pcs

■ TKITT06.\_/BG4K 0.15m³ / 18.5kg / 1pcs  
 ■ TKITT06.\_/BG4K.10 0.15m³ / 18.5kg / 1pcs

■ TKITT23.\_/BG4K 0.16m³ / 21.1kg / 1pcs  
 ■ TKITT23.\_/BG4K.10 0.16m³ / 21.1kg / 1pcs

## TKITT.BGA4K

H115 Table with technopolymer top, BG4K 4-spur metal-technopolymer co-injected table base, Ø 80mm anodized aluminum column.

Tavolo con piano in tecnopolimero H115, basamento BG4K a quattro razze in metallo sovrastampato con tecnopolimero, colonna in alluminio anodizzato Ø 80mm.



■ TKITT04.\_/BGA4K 0.17m³ / 17.3kg / 1pcs  
 ■ TKITT04.\_/BGA4K.10 0.17m³ / 17.3kg / 1pcs

■ TKITT03.\_/BGA4K 0.19m³ / 18kg / 1pcs  
 ■ TKITT03.\_/BGA4K.10 0.19m³ / 18kg / 1pcs

■ TKITT20.\_/BGA4K 0.17m³ / 18.1kg / 1pcs  
 ■ TKITT20.\_/BGA4K.10 0.17m³ / 18.1kg / 1pcs

■ TKITT06.\_/BGA4K 0.19m³ / 19.3kg / 1pcs  
 ■ TKITT06.\_/BGA4K.10 0.19m³ / 19.3kg / 1pcs

Top Color / Colore Piano





# TKITT.BG4J

H73 Table with technopolymer top, BG4J 4-spur metal-technopolymer co-injected table base, 80x80mm anodized aluminum column.

Tavolo con piano in tecnopolimero H73, basamento BG4J a quattro razze in metallo sovrastampato con tecnopolimero, colonna in alluminio anodizzato 80x80mm.

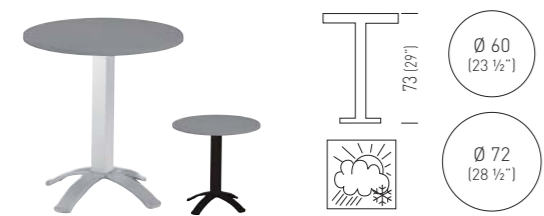

■ TKITT04\_/BG4J 0.16m<sup>3</sup> / 16.8kg / 1pcs  
 ■ TKITT04\_/BG4J.10 0.16m<sup>3</sup> / 16.8kg / 1pcs

■ TKITT03\_/BG4J 0.18m<sup>3</sup> / 17.5kg / 1pcs  
 ■ TKITT03\_/BG4J.10 0.18m<sup>3</sup> / 17.5kg / 1pcs



■ TKITT20\_/BG4J 0.16m<sup>3</sup> / 17.6kg / 1pcs  
 ■ TKITT20\_/BG4J.10 0.16m<sup>3</sup> / 17.6kg / 1pcs

■ TKITT06\_/BG4J 0.18m<sup>3</sup> / 18.8kg / 1pcs  
 ■ TKITT06\_/BG4J.10 0.18m<sup>3</sup> / 18.8kg / 1pcs

■ TKITT23\_/BG4J 0.19m<sup>3</sup> / 21.4kg / 1pcs  
 ■ TKITT23\_/BG4J.10 0.19m<sup>3</sup> / 21.4kg / 1pcs

# TKITT.BGPK

H75 folding table with technopolymer top, BG4J 4-spur metal-technopolymer co-injected base, Ø 80mm anodized aluminum column with flip-top mechanism.

Tavolo pieghevole con piano in tecnopolimero H75, basamento BGPK a quattro razze in metallo sovrastampato con tecnopolimero, colonna in alluminio anodizzato Ø 80mm.

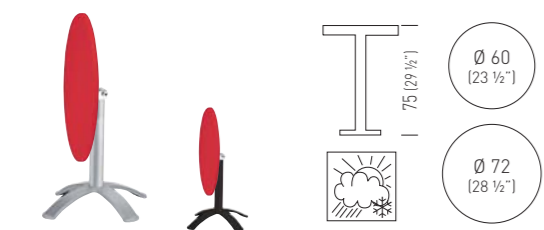

■ TKITT04\_/BGPK 0.13m<sup>3</sup> / 17.5kg / 1pcs  
 ■ TKITT04\_/BGPK.10 0.13m<sup>3</sup> / 17.5kg / 1pcs

■ TKITT03\_/BGPK 0.15m<sup>3</sup> / 18.2kg / 1pcs  
 ■ TKITT03\_/BGPK.10 0.15m<sup>3</sup> / 18.2kg / 1pcs

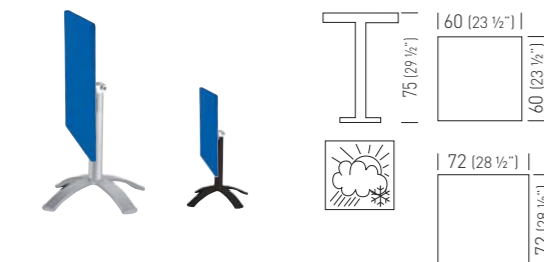

■ TKITT20\_/BGPK 0.13m<sup>3</sup> / 18.3kg / 1pcs  
 ■ TKITT20\_/BGPK.10 0.13m<sup>3</sup> / 18.3kg / 1pcs

■ TKITT06\_/BGPK 0.15m<sup>3</sup> / 19.5kg / 1pcs  
 ■ TKITT06\_/BGPK.10 0.15m<sup>3</sup> / 19.5kg / 1pcs

■ TKITT23\_/BGPK 0.16m<sup>3</sup> / 22.1kg / 1pcs  
 ■ TKITT23\_/BGPK.10 0.16m<sup>3</sup> / 22.1kg / 1pcs

Top Color / Colore Piano



# TKITT.BGPJ

H75 folding table with technopolymer top, BG4J 4-spur metal-technopolymer co-injected base, 80x80mm anodized aluminum column with flip-top mechanism.

Tavolo pieghevole con piano in tecnopolimero H75, basamento BGPJ a quattro razze in metallo sovrastampato con tecnopolimero, colonna in alluminio anodizzato 80x80mm.

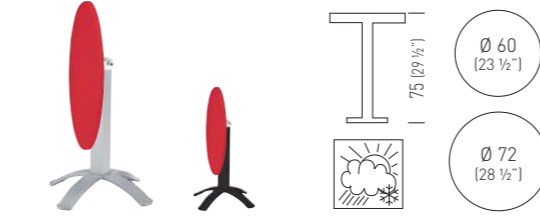

■ TKITT04\_/BGPJ 0.16m<sup>3</sup> / 17.8kg / 1pcs  
 ■ TKITT04\_/BGPJ.10 0.16m<sup>3</sup> / 17.8kg / 1pcs

■ TKITT03\_/BGPJ 0.18m<sup>3</sup> / 18.5kg / 1pcs  
 ■ TKITT03\_/BGPJ.10 0.18m<sup>3</sup> / 18.5kg / 1pcs

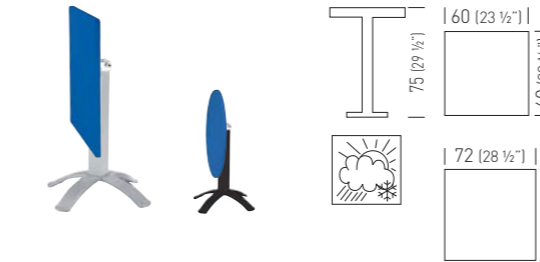

■ TKITT20\_/BGPJ 0.16m<sup>3</sup> / 18.6kg / 1pcs  
 ■ TKITT20\_/BGPJ.10 0.16m<sup>3</sup> / 18.6kg / 1pcs

■ TKITT06\_/BGPJ 0.18m<sup>3</sup> / 19.8kg / 1pcs  
 ■ TKITT06\_/BGPJ.10 0.18m<sup>3</sup> / 19.8kg / 1pcs

■ TKITT23\_/BGPJ 0.19m<sup>3</sup> / 22.4kg / 1pcs  
 ■ TKITT23\_/BGPJ.10 0.19m<sup>3</sup> / 22.4kg / 1pcs

Top Color / Colore Piano





# TKITT.BG4IP

Folding and stacking H75 table with technopolymer top, BG4IP 4-spur metal-technopolymer co-injected table base, Ø 80mm anodized aluminum column with flip-top mechanism and adjustable feet.

Tavolo pieghevole e accatastabile con piano in tecnopolimero H75, basamento BG4IP a quattro razze in metallo sovrastampato con tecnopolimero, colonna in alluminio anodizzato Ø 80mm e piedini regolabili.

■ TKITT04._/BG4IP	0.13m³ / 14kg / 1pcs
■ TKITT04._/BG4IP.10	0.13m³ / 14kg / 1pcs
■ TKITT03._/BG4IP	0.15m³ / 14.7kg / 1pcs
■ TKITT03._/BG4IP.10	0.15m³ / 14.7kg / 1pcs
■ TKITT20._/BG4IP	0.13m³ / 14.8kg / 1pcs
■ TKITT20._/BG4IP.10	0.13m³ / 14.8kg / 1pcs
■ TKITT06._/BG4IP	0.15m³ / 16kg / 1pcs
■ TKITT06._/BG4IP.10	0.15m³ / 16kg / 1pcs
■ TKITT23._/BG4IP	0.16m³ / 18.5kg / 1pcs
■ TKITT23._/BG4IP.10	0.16m³ / 18.5kg / 1pcs

Top Color / Colore Piano

00 01 06 09 10 14 42 52 99





## TKITT.BTK

H75 Table with technopolymer top, round BTK metal-technopolymer co-injected base, Ø 80mm anodized aluminum column.

Tavolo con piano in tecnopolimero H75, basamento BTK rotondo in metallo sovrastampato con tecnopolimero, colonna in alluminio anodizzato Ø 80mm.

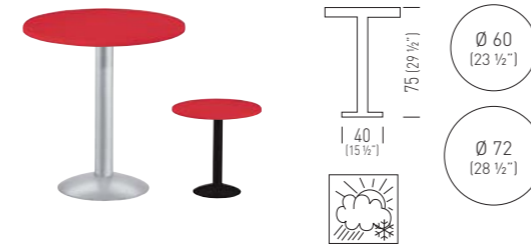

■ TKITT04._/BTK	0.16m³ / 13.8kg / 1pcs
■ TKITT04._/BTK.10	0.16m³ / 13.8kg / 1pcs
■ TKITT03._/BTK	0.18m³ / 14.5kg / 1pcs
■ TKITT03._/BTK.10	0.18m³ / 14.5kg / 1pcs

## TKITT.BTAK

H110 Table with technopolymer top, round BTAK metal-technopolymer co-injected base, Ø 80mm anodized aluminum column.

Tavolo con piano in tecnopolimero H110, basamento BTAK rotondo in metallo sovrastampato con tecnopolimero, colonna in alluminio anodizzato Ø 80mm.

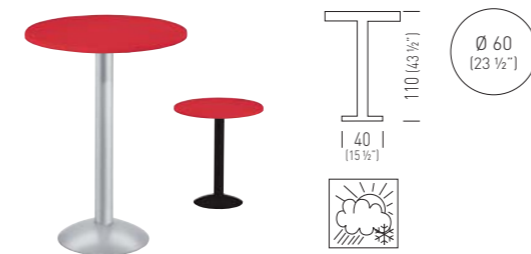

■ TKITT04._/BTAK	0.17m³ / 14.8kg / 1pcs
■ TKITT04._/BTAK.10	0.17m³ / 14.8kg / 1pcs

Top Color / Colore Piano







## TKITT.BTK54

H75 Table with technopolymer top, round BTK54 metal-technopolymer co-injected table base, Ø 80mm anodized aluminum column.

Tavolo con piano in tecnopolimero H75, basamento BTK54 rotondo in metallo sovrastampato con tecnopolimero, colonna in alluminio anodizzato Ø 80mm.

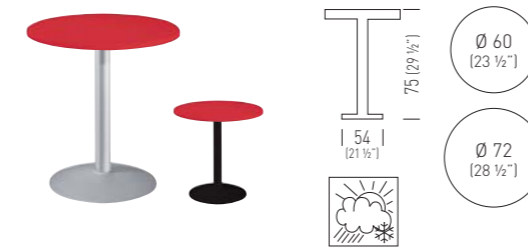

■ TKITT04._/BTK54	📦 0.16m <sup>3</sup> / 16.3kg / 1pcs
■ TKITT04._/BTK54.10	📦 0.16m <sup>3</sup> / 16.3kg / 1pcs
■ TKITT03._/BTK54	📦 0.18m <sup>3</sup> / 17kg / 1pcs
■ TKITT03._/BTK54.10	📦 0.18m <sup>3</sup> / 17kg / 1pcs

## TKITT.BTAK54

H110 Table with technopolymer top, round BTK54 metal-technopolymer co-injected table base, Ø 80mm anodized aluminum column.

Tavolo con piano in tecnopolimero H110, basamento BTAK54 rotondo in metallo sovrastampato con tecnopolimero, colonna in alluminio anodizzato Ø 80mm.

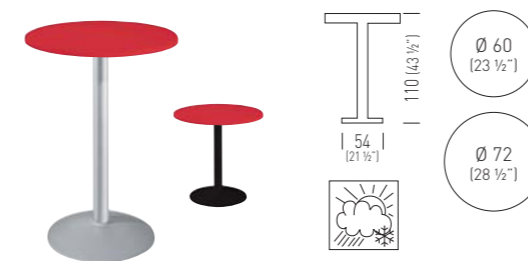

■ TKITT04._/BTAK54	📦 0.17m <sup>3</sup> / 17.3kg / 1pcs
■ TKITT04._/BTAK54.10	📦 0.17m <sup>3</sup> / 17.3kg / 1pcs
■ TKITT03._/BTAK54	📦 0.19m <sup>3</sup> / 18kg / 1pcs
■ TKITT03._/BTAK54.10	📦 0.19m <sup>3</sup> / 18kg / 1pcs

Top Color / Colore Piano







## TKITT.DPBT54

H110 double table with technopolymer tops, round DPBT54 metal-technopolymer co-injected base, Ø 80mm anodized aluminum column.

Tavolo con doppio piano in tecnopolimero H110, basamento DPBT54 rotondo in metallo sovrastampato con tecnopolimero, colonna in alluminio anodizzato Ø 80mm.

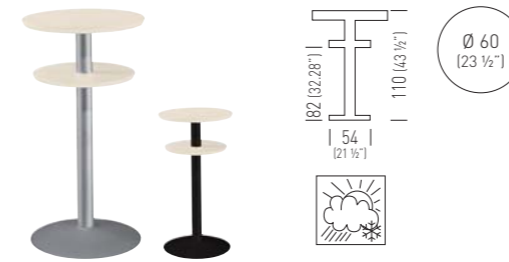

- TKITT08./DPBT54  0.15m³ / 16.5kg / 1pcs
- TKITT08./DPBT54.10  0.15m³ / 16.5kg / 1pcs

Top Color / Colore Piano







# TKITT.BRK

H75 Table with technopolymer top, round BRK metal-technopolymer co-injected base, Ø 80mm anodized aluminum column.

Tavolo con piano in tecnopolimero H75, basamento BRK rotondo in metallo sovrastampato con tecnopolimero, colonna in alluminio anodizzato Ø 80mm.

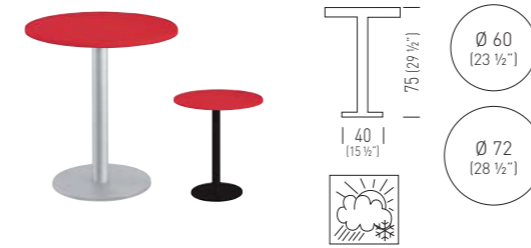

- |                    |                        |
|--------------------|------------------------|
| ■ TKITT04._/BRK    | 0.13m³ / 14.3kg / 1pcs |
| ■ TKITT04._/BRK.10 | 0.13m³ / 14.3kg / 1pcs |
| ■ TKITT03._/BRK    | 0.15m³ / 15kg / 1pcs   |
| ■ TKITT03._/BRK.10 | 0.15m³ / 15kg / 1pcs   |

Top Color / Colore Piano







## TKITT.BQJ

H74 Table with technopolymer top, square BQJ metal-technopolymer co-injected table base, 80x80mm anodized aluminum column.

Tavolo con piano in tecnopolimero H74, basamento BQJ quadrato in metallo sovrastampato con tecnopolimero, colonna in alluminio anodizzato 80x80mm.

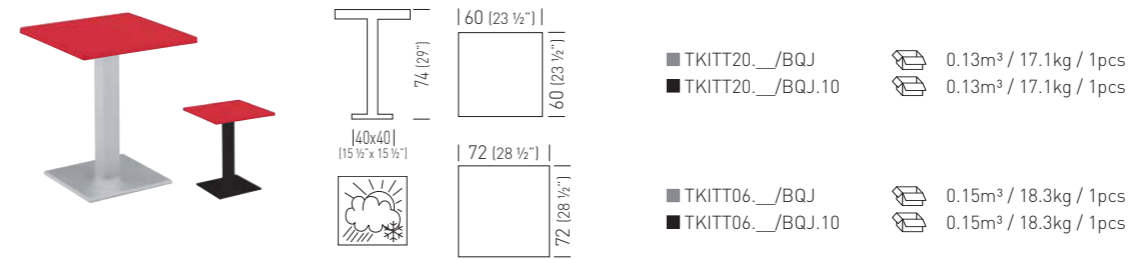

## TKITT.BQAJ

H103 Table with technopolymer top, square BQJ metal-technopolymer co-injected table base, 80x80mm anodized aluminum column.

Tavolo con piano in tecnopolimero H103, basamento BQJ quadrato in metallo sovrastampato con tecnopolimero, colonna in alluminio anodizzato 80x80mm.

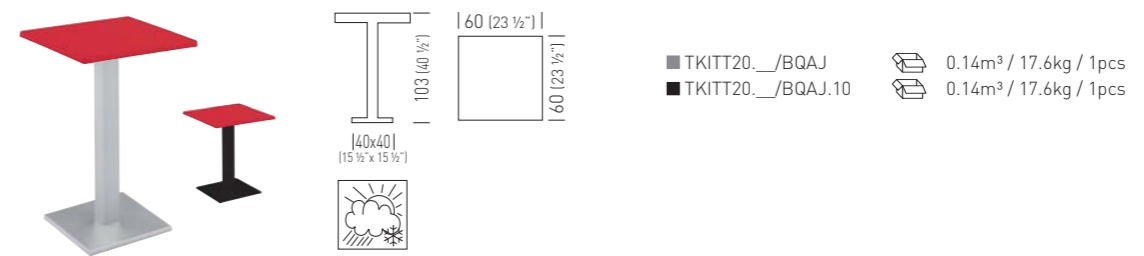

Top Color / Colore Piano





# TIMPT.STAKY

Stackable table collection, suitable for outdoor use.  
Techno polymer tops and anodized aluminum frames.

Collezione di tavoli impilabili, adatti all'uso esterno.  
I tavoli sono realizzati con piani in tecnopolimero e struttura in alluminio anodizzato.







# TCONT.STEADY

Counterbalanced tables collection, suitable for outdoor use.  
Techno polymer tops and anodized aluminum frames.

Collezione di tavoli a contrappesi, adatti all'uso esterno.  
I tavoli sono realizzati con piani in tecnopolimero e struttura in alluminio anodizzato.



TCONT06.\_/H75

0.08m<sup>3</sup> / 12.8kg / 1pcs



TCONT23.\_/H75

0.10m<sup>3</sup> / 13kg / 1pcs



TCONT03.\_/H75

0.08m<sup>3</sup> / 12.6kg / 1pcs

Top Color / Colore Piano



TABLE TOPS  
**Collection**



# Standard Compactop Surfaces



Flat black edge  
Bordo piatto nero



Sizes / Misure	Code / Codice	
Ø 60 (23 1/2")	PTC101._	0.054m³ / 11kg / 2pcs
Ø 68 (27")	PTC103._	0.074m³ / 13kg / 2pcs
59x59 (23"x23")	PTC102._	0.054m³ / 12kg / 2pcs
68x68 (27"x27")	PTC104._	0.074m³ / 19kg / 2pcs
79x79 (31"x31")	PTC106._	0.090m³ / 20kg / 2pcs
89x89 (35"x35")	PTC107._	0.11m³ / 25kg / 2pcs

## ABOUT COMPACTOP: MUCH MORE THAN A MERE SURFACE

Gaber Compactops are made of high-pressure laminate, consisting of numerous layers of paper saturated with thermosetting resins and bonded through the combined action of heat and high pressure. The paper used on Compactop (around 70% of the complete composition) comes from production processes that conform with the FSC chain of custody; phenolic and melamine resins are all strictly water-based.

The result is a stable, non-reactive, homogenous, non-porous, antistatic, high-density product with a totally distinct physical and chemical profile from that of its constituent parts. Thanks to the heat and high-pressure treatment it they undergo, Gaber Compactops are exceptionally tough and resistant to scratches, abrasions, chemicals and heat, making them ideal for a wide range of contract applications. Tops come pre-bored for Gaber kit bases.

Gaber Compactops conform to EN 438/1. According to this norm, the most important characteristics of Gaber Compactops are: their resistance to bumps, scratches, and wear and tear; color-fastness; easy cleanability; suitable for contact with food and general hygiene.

UNI EN 438 is the reference standard for Compactop Gaber tops. This standard prescribes tolerances in the flatness of the product and on possible stains and other similar surface defects, for which the admissible size is based on a maximum contamination area equivalent to 1mm² / m² of laminate, concentrated in a single point or distributed in more points, proportional to the size of the sheet under inspection.

## MAINTENANCE & CLEANING

No specific maintenance other than normal cleaning is required. The compact, non porous surface can easily be cleaned and disinfected with hot water, steam and any common non-abrasive household detergents and disinfectants, as long as these are not highly alkaline. Just a couple of precautions are necessary: avoid using strong acids and bases and avoid wiping with highly abrasive substances or equipment.

## CHE COS'È IL COMPACTOP? MOLTO PIÙ DI UNA SEMPLICE SUPERFICIE

Il Compactop che Gaber utilizza per i propri tavoli è un laminato realizzato ad alta pressione, costituito da numerosi strati di carta impregnati con resine termoindurenti fenoliche e melaminiche, compattati attraverso l'azione combinata di calore ed alta pressione. Le carte utilizzate (circa il 70% della composizione dei piani) derivano da processi che seguono il protocollo della catena di custodia certificata FSC; le resine fenoliche e melaminiche sono tutte rigorosamente realizzate su base acqua.

Il risultato è un prodotto stabile, non reattivo, omogeneo, non poroso, antistatico e di alta densità. Grazie al trattamento di alta temperatura e pressione cui è sottoposto, il Compactop è un materiale estremamente robusto: resistente a graffi, urti, abrasioni, sostanze chimiche e calore; caratteristiche che lo rendono il materiale ideale per una vasta gamma di applicazioni. I fissaggi dei piani Compactop sono già predisposti per i basamenti Gaber.

Il Compactop è conforme alla norma EN 438/1, secondo la quale, queste sono le principali caratteristiche di qualità di questo materiale: Resistente all'impatto, ai graffi e all'usura, stabile alla luce, facile da pulire, igienico, adatto al contatto con i cibi.

La UNI EN 438 è la norma di riferimento dei piani in Compactop Gaber. Tale normativa prescrive tolleranze nella planarità del prodotto e su possibili macchie e altri difetti superficiali simili, per i quali la dimensione ammissibile è basata su un'area di contaminazione massima equivalente a 1mm²/m² di laminato, concentrata in un unico punto o dispersa in più punti, proporzionale alla dimensione del foglio sottoposto a ispezione.

## MANUTENZIONE E PULIZIA

Il Compactop non richiede alcuna manutenzione particolare al di là della normale pulizia.

La sua superficie compatta e non porosa può essere facilmente pulita e disinfettata con acqua calda, vapore e tutti i tipi dei più comuni detergenti e disinfettanti per uso domestico, purché non alcalini. Sono necessarie solo poche precauzioni, quali l'evitare l'uso di acidi o basi forti, evitare di strofinare con sostanze o strumenti fortemente abrasivi.

# Special Compactop Surfaces Fullcolor



Chamfered edge  
Bordo smussato



Sizes / Misure	Code / Codice	
Ø 60 (23 1/2")	PTC301.00	0.054m³ / 12kg / 2pcs
Ø 68 (27")	PTC303.00	0.074m³ / 14kg / 2pcs
Ø 80 (31 1/2")	PTC305.00	0.09m³ / 19kg / 2pcs
Ø 100 (39 1/2")	PTC308.00	0.20m³ / 31kg / 2pcs
Ø 120 (47")	PTC309.00	0.26m³ / 44kg / 2pcs
Ø 140 (55")	PTC315.00	0.30m³ / 50kg / 2pcs
59x59 (23"x23")	PTC302.00	0.054m³ / 13kg / 2pcs
68x68 (27"x27")	PTC304.00	0.074m³ / 21kg / 2pcs
79x79 (31"x31")	PTC306.00	0.090m³ / 22kg / 2pcs
89x89 (35"x35")	PTC307.00	0.11m³ / 27kg / 2pcs
120x50 (47"x19 1/2")	PTC310.00	0.20m³ / 23kg / 2pcs
140x70 (55"x27 1/2")	PTC311.00	0.20m³ / 40kg / 2pcs
120x80 (47"x31 1/2")	PTC312.00	0.20m³ / 33kg / 2pcs
159x79 (62 1/2"x31")	PTC314.00	0.26m³ / 46kg / 2pcs

## ABOUT COMPACTOP: MUCH MORE THAN A MERE SURFACE

Gaber Compactops are made of high-pressure laminate, consisting of numerous layers of paper saturated with thermosetting resins and bonded through the combined action of heat and high pressure. The paper used on Compactop (around 70% of the complete composition) comes from production processes that conform with the FSC chain of custody; phenolic and melamine resins are all strictly water-based.

The result is a stable, non-reactive, homogenous, non-porous, antistatic, high-density product with a totally distinct physical and chemical profile from that of its constituent parts. Thanks to the heat and high-pressure treatment it they undergo, Gaber Compactops are exceptionally tough and resistant to scratches, abrasions, chemicals and heat, making them ideal for a wide range of contract applications. Tops come pre-bored for Gaber Kit bases.

Gaber Compactops conform to EN 438/1. According to this norm, the most important characteristics of Gaber Compactops are: their resistance to bumps, scratches, and wear and tear; color-fastness; easy cleanability; suitable for contact with food and general hygiene.

UNI EN 438 is the reference standard for Compactop Gaber tops. This standard prescribes tolerances in the flatness of the product and on possible stains and other similar surface defects, for which the admissible size is based on a maximum contamination area equivalent to 1mm² / m² of laminate, concentrated in a single point or distributed in more points, proportional to the size of the sheet under inspection.

## MAINTENANCE & CLEANING

No specific maintenance other than normal cleaning is required. The compact, non porous surface can easily be cleaned and disinfected with hot water, steam and any common non-abrasive household detergents and disinfectants, as long as these are not highly alkaline. Just a couple of precautions are necessary: avoid using strong acids and bases and avoid wiping with highly abrasive substances or equipment.

## CHE COS'È IL COMPACTOP? MOLTO PIÙ DI UNA SEMPLICE SUPERFICIE

Il Compactop che Gaber utilizza per i propri tavoli è un laminato realizzato ad alta pressione, costituito da numerosi strati di carta impregnati con resine termoindurenti fenoliche e melaminiche, compattati attraverso l'azione combinata di calore ed alta pressione. Le carte utilizzate (circa il 70% della composizione dei piani) derivano da processi che seguono il protocollo della catena di custodia certificata FSC; le resine fenoliche e melaminiche sono tutte rigorosamente realizzate su base acqua.

Il risultato è un prodotto stabile, non reattivo, omogeneo, non poroso, antistatico e di alta densità. Grazie al trattamento di alta temperatura e pressione cui è sottoposto, il Compactop è un materiale estremamente robusto: resistente a graffi, urti, abrasioni, sostanze chimiche e calore; caratteristiche che lo rendono il materiale ideale per una vasta gamma di applicazioni. I fissaggi dei piani Compactop sono già predisposti per i basamenti Gaber.

Il Compactop è conforme alla norma EN 438/1, secondo la quale, queste sono le principali caratteristiche di qualità di questo materiale: Resistente all'impatto, ai graffi e all'usura, stabile alla luce, facile da pulire, igienico, adatto al contatto con i cibi.

La UNI EN 438 è la norma di riferimento dei piani in Compactop Gaber. Tale normativa prescrive tolleranze nella planarità del prodotto e su possibili macchie e altri difetti superficiali simili, per i quali la dimensione ammissibile è basata su un'area di contaminazione massima equivalente a 1mm²/m² di laminato, concentrata in un unico punto o dispersa in più punti, proporzionale alla dimensione del foglio sottoposto a ispezione.

## MANUTENZIONE E PULIZIA

Il Compactop non richiede alcuna manutenzione particolare al di là della normale pulizia.

La sua superficie compatta e non porosa può essere facilmente pulita e disinfettata con acqua calda, vapore e tutti i tipi dei più comuni detergenti e disinfettanti per uso domestico, purché non alcalini. Sono necessarie solo poche precauzioni, quali l'evitare l'uso di acidi o basi forti, evitare di strofinare con sostanze o strumenti fortemente abrasivi.

The white color of Compactop Fullcolor Surface is specific as it is combined with the color of the edge.  
Il colore bianco del Compactop Fullcolor è specifico in quanto abbinato al colore del bordo

Flat edge  
Bordo piatto

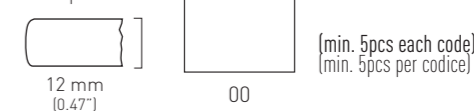

Sizes / Misure	Code / Codice	
Ø 60 (23 1/2")	PTC201.00	0.054m³ / 12kg / 2pcs
Ø 68 (27")	PTC203.00	0.074m³ / 14kg / 2pcs
Ø 80 (31 1/2")	PTC205.00	0.09m³ / 19kg / 2pcs
Ø 100 (39 1/2")	PTC208.00	0.20m³ / 31kg / 2pcs
Ø 120 (47")	PTC209.00	0.26m³ / 44kg / 2pcs
Ø 140 (55")	PTC215.00	0.30m³ / 50kg / 2pcs
59x59 (23"x23")	PTC202.00	0.054m³ / 13kg / 2pcs
68x68 (27"x27")	PTC204.00	0.074m³ / 21kg / 2pcs
79x79 (31"x31")	PTC206.00	0.090m³ / 22kg / 2pcs
89x89 (35"x35")	PTC207.00	0.11m³ / 27kg / 2pcs
120x50 (47"x19 1/2")	PTC210.00	0.20m³ / 23kg / 2pcs
140x70 (55"x27 1/2")	PTC211.00	0.20m³ / 40kg / 2pcs
120x80 (47"x31 1/2")	PTC212.00	0.20m³ / 33kg / 2pcs
159x79 (62 1/2"x31")	PTC214.00	0.26m³ / 46kg / 2pcs

# Special Compactop Surfaces

## 10



Flat black edge  
Bordo piatto nero

10 mm  
(0.39")

(min. 20pcs each code)  
(min. 20pcs per codice)

### Solid

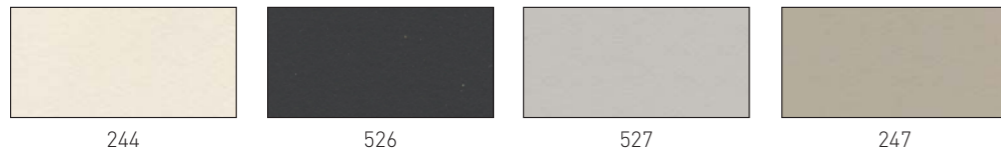

### Stone, Concrete effect

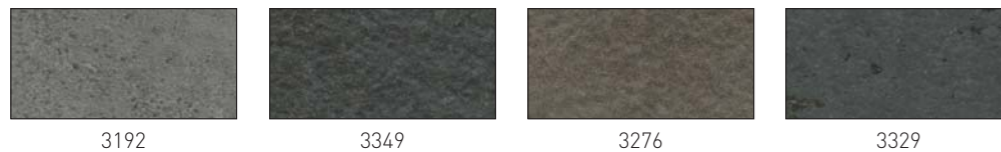





### Wood effect

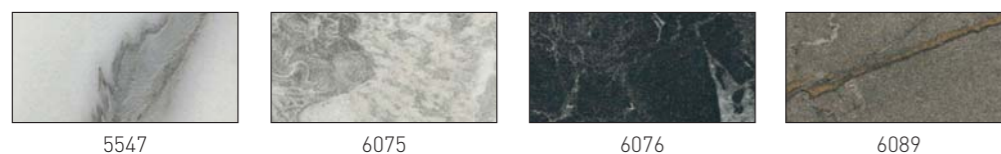

### Marble effect



	Sizes / Misure	Code / Codice	
	Ø 60 (23 1/2")	PTC501. __	0.700m³ / 95kg / 20pcs
	Ø 68 (27")	PTC503. __	0.700m³ / 120kg / 20pcs
	Ø 80 (31 1/2")	PTC505. __	0.84m³ / 185kg / 20pcs
	Ø 100 (39 1/2")	PTC508. __	1.20m³ / 285kg / 20pcs
	Ø 120 (47")	PTC509. __	1.20m³ / 405kg / 20pcs
	Ø 140 (55")	PTC515. __	1.60m³ / 535kg / 20pcs
	59x59 (23"x23")	PTC502. __	0.700m³ / 115kg / 20pcs
	68x68 (27"x27")	PTC504. __	0.700m³ / 155kg / 20pcs
	79x79 (31"x31")	PTC506. __	0.840m³ / 195kg / 20pcs
	89x89 (35"x35")	PTC507. __	0.840m³ / 245kg / 20pcs
	120x50 (47"x19 1/2")	PTC510. __	0.84m³ / 225kg / 20pcs
	140x70 (55"x27 1/2")	PTC511. __	0.95m³ / 355kg / 20pcs
	120x80 (47"x31 1/2")	PTC512. __	0.84m³ / 345kg / 20pcs
	159x79 (62 1/2"x31")	PTC514. __	1.20m³ / 455kg / 20pcs

### ABOUT COMPACTOP: MUCH MORE THAN A MERE SURFACE

Gaber Compactops are made of high-pressure laminate, consisting of numerous layers of paper saturated with thermosetting resins and bonded through the combined action of heat and high pressure. The paper used on Compactop (around 70% of the complete composition) comes from production processes that conform with the FSC chain of custody; phenolic and melamine resins are all strictly water-based. The result is a stable, non-reactive, homogenous, non-porous, antistatic, high-density product with a totally distinct physical and chemical profile from that of its constituent parts. Thanks to the heat and high-pressure treatment it they undergo, Gaber Compactops are exceptionally tough and resistant to scratches, abrasions, chemicals and heat, making them ideal for a wide range of contract applications. Tops come pre-bored for Gaber kit bases. Gaber Compactops conform to EN 438/1. According to this norm, the most important characteristics of Gaber Compactops are: their resistance to bumps, scratches, and wear and tear; color-fastness; easy cleanability; suitable for contact with food and general hygiene. UNI EN 438 is the reference standard for Compactop Gaber tops. This standard prescribes tolerances in the flatness of the product and on possible stains and other similar surface defects, for which the admissible size is based on a maximum contamination area equivalent to 1mm² / m² of laminate, concentrated in a single point or distributed in more points, proportional to the size of the sheet under inspection.

### MAINTENANCE & CLEANING

No specific maintenance other than normal cleaning is required. The compact, non porous surface can easily be cleaned and disinfected with hot water, steam and any common non-abrasive household detergents and disinfectants, as long as these are not highly alkaline. Just a couple of precautions are necessary: avoid using strong acids and bases and avoid wiping with highly abrasive substances or equipment.

### CHE COS'È IL COMPACTOP? MOLTO PIÙ DI UNA SEMPLICE SUPERFICIE

Il Compactop che Gaber utilizza per i propri tavoli è un laminato realizzato ad alta pressione, costituito da numerosi strati di carta impregnati con resine termoindurenti fenoliche e melaminiche, compattati attraverso l'azione combinata di calore ed alta pressione. Le carte utilizzate (circa il 70% della composizione dei piani) derivano da processi che seguono il protocollo della catena di custodia certificata FSC; le resine fenoliche e melaminiche sono tutte rigorosamente realizzate su base acquosa. Il risultato è un prodotto stabile, non reattivo, omogeneo, non poroso, antistatico e di alta densità. Grazie al trattamento di alta temperatura e pressione cui è sottoposto, il Compactop è un materiale estremamente robusto: resistente a graffi, urti, abrasioni, sostanze chimiche e calore; caratteristiche che lo rendono il materiale ideale per una vasta gamma di applicazioni. I fissaggi dei piani Compactop sono già predisposti per i basamenti Gaber. Il Compactop è conforme alla norma EN 438/1, secondo la quale, queste sono le principali caratteristiche di qualità di questo materiale: Resistente all'impatto, ai graffi e all'usura, stabile alla luce, facile da pulire, igienico, adatto al contatto con i cibi.

La UNI EN 438 è la norma di riferimento dei piani in Compactop Gaber. Tale normativa prescrive tolleranze nella planarità del prodotto e su possibili macchie e altri difetti superficiali simili, per i quali la dimensione ammissibile è basata su un'area di contaminazione massima equivalente a 1mm²/m² di laminato, concentrata in un unico punto o dispersa in più punti, proporzionale alla dimensione del foglio sottoposto a ispezione.

### MANUTENZIONE E PULIZIA

Il Compactop non richiede alcuna manutenzione particolare al di là della normale pulizia.

La sua superficie compatta e non porosa può essere facilmente pulita e disinfettata con acqua calda, vapore e tutti i tipi dei più comuni detergenti e disinfettanti per uso domestico, purché non alcalini. Sono necessarie solo poche precauzioni, quali l'evitare l'uso di acidi o basi forti, evitare di strofinare con sostanze o strumenti fortemente abrasivi.



# Special Compactop Surfaces

## Fenix

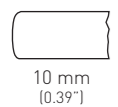

Flat black edge  
Bordo piatto nero

(min. 20pcs each code)  
(min. 20pcs per codice)

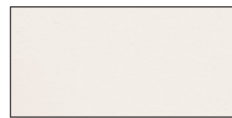

0029

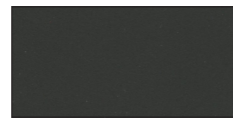

0720

	Sizes / Misure	Code / Codice	
○	Ø 60 (23 ½")	PTC401.__	0.70m³ / 95kg / 20pcs
	Ø 68 (27")	PTC403.__	0.70m³ / 120kg / 20pcs
□	59x59 (23"x23")	PTC402.__	0.70m³ / 115kg / 20pcs
	68x68 (27"x27")	PTC404.__	0.70m³ / 155kg / 20pcs
	79x79 (31"x31")	PTC406.__	0.84m³ / 195kg / 20pcs
	89x89 (35"x35")	PTC407.__	0.84m³ / 245kg / 20pcs

### ABOUT FENIX COMPACTOP

Gaber's Fenix Compactop differ from standards as they are built with new generation materials on exposed coated surfaces, made using nanoparticles and acrylic resins. This coating avoid fingerprints on the material, make it soft-touch, heat-repairing, opaque and extremely resistant to bumps and scratches. In addition to this, the material is water repellent, hygienic, easy to clean and suitable for food-contact.

### MAINTENANCE & CLEANING

No specific maintenance other than normal cleaning is required. The compact, non porous surface can easily be cleaned and disinfected with a soft cloth dampened with hot water, steam and any common non-abrasive household detergents and disinfectants, as long as these are not highly alkaline. Just a couple of precautions are necessary: avoid using strong acids and bases and avoid wiping with highly abrasive substances or equipment.

### CHE COS'È IL FENIX COMPACTOP

I piani Compactop Fenix di Gaber differiscono dagli standard in quanto prevedono l'utilizzo delle superfici esposte rivestite con materiali di nuova generazione, realizzati per mezzo dell'uso di nanoparticelle e resine acriliche. Tali rivestimenti rendono il materiale anti-impronta, morbido al tatto, termo-riparatore, opaco ed estremamente resistente ad urti e graffi. Oltre a ciò, il materiale è idrorepellente, igienico, resistente alle muffe, facile da pulire e adatto al contatto con alimenti.

### MANUTENZIONE E PULIZIA

Il Compactop non richiede alcuna manutenzione particolare al di là della normale pulizia. La sua superficie compatta e non porosa può essere facilmente pulita e disinfettata con un panno umido, acqua calda, vapore e tutti i tipi dei più comuni detergenti e disinfettanti per uso domestico, purché non alcalini. Sono necessarie solo poche precauzioni, quali l'evitare l'uso di acidi o basi forti, evitare di strofinare con sostanze o strumenti fortemente abrasivi.

# Standard Laminated Surfaces

## 22

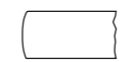

22 mm  
(0.86")



For orders under 10no. surcharge 20€ each unit  
Per ordini inferiori ai 10pz + €20,00 ogni unità.

Bottom surfaces of our laminated tops are in white, black or dark grey colors.  
Il fondo del piano laminato può essere con colore bianco, nero o grigio antracite.

	Sizes / Misure	Code / Codice	
○	Ø 60 (23 ½")	PTL101.__	0.054m³ / 11kg / 2pcs
	Ø 70 (27 ½")	PTL103.__	0.074m³ / 13kg / 2pcs
	Ø 80 (31 ½")	PTL105.__	0.090m³ / 14kg / 2pcs
	Ø 90 (35 ½")	PTL127.__	0.110m³ / 16kg / 2pcs
	Ø 100 (39 ½")	PTL108.__	0.200m³ / 20kg / 2pcs
	Ø 120 (47")	PTL109.__	0.260m³ / 27kg / 2pcs
	Ø 140 (55")	PTL115.__	0.300m³ / 33kg / 2pcs
□	60x60 (23 ½"x23 ½")	PTL102.__	0.054m³ / 13kg / 2pcs
	70x70 (27 ½"x27 ½")	PTL104.__	0.074m³ / 19kg / 2pcs
	80x80 (31 ½"x31 ½")	PTL106.__	0.090m³ / 24kg / 2pcs
	90x90 (35 ½"x35 ½")	PTL107.__	0.110m³ / 27kg / 2pcs
	100x100 (39 ½"x39 ½")	PTL128.__	0.200m³ / 28kg / 2pcs
□	120x50 (47"x19 ½")	PTL110.__	0.110m³ / 27kg / 2pcs
	120x80 (47"x31 ½")	PTL112.__	0.200m³ / 30kg / 2pcs
	140x70 (55"x27 ½")	PTL111.__	0.200m³ / 34kg / 2pcs
	160x80 (63"x31 ½")	PTL114.__	0.260m³ / 36kg / 2pcs

### ABOUT LAMINATED TABLE TOPS

Gaber's laminate table tops are composed of a high-pressure decorative laminate layer, with a recycled-wood chipboard core and ABS edging. Gaber's support materials are E1 according to tests stipulated by the European standards EN717 and EN120 regarding formaldehyde emission. Laminate tops come ready for Gaber kit bases.

The result is homogeneous, static, lightweight and highly customizable in terms of shapes and finishes.

Our laminate tops are manufactures according the following European Standards related to fire reaction: EN 13501-1:2009 B -s2, d0.

### MAINTENANCE & CLEANING

Gaber laminated table tops do not require any special maintenance beyond normal cleaning.

Laminated surfaces can be easily cleaned with a soft cloth dampened with water, even with cleaning agents, but not alkaline and generally aggressive. Avoid the use of strong acids or bases, avoid wiping with abrasive substances or equipment.

### COSA SONO I PIANI DEI TAVOLI IN LAMINATO?

I ripiani laminati che Gaber utilizza per i propri tavoli sono composti da uno strato di laminato decorativo ad alta pressione, supportato da un pannello di truciolare; quest'ultimo realizzato con i materiali di scarto delle normali lavorazioni del legno. I piani sono bordati con bordo in Abs. La tipologia di supporto utilizzato da Gaber per i propri piani è di classe E1 secondo i test espressi dalle normative europee EN717 e EN120 in materia di emissione di formaldeide. I fissaggi dei ripiani in Laminato sono già predisposti per i basamenti Gaber.

Il risultato è un prodotto omogeneo, antistatico, leggero e facilmente personalizzabile in forme e finiture.

I nostri piani in laminato sono realizzati secondo la normativa europea di reazione al fuoco EN 13501-1:2009 B -s2, d0.

### MANUTENZIONE E PULIZIA

I piani Laminati di Gaber non richiedono alcuna manutenzione particolare al di là della normale pulizia.

La sua superficie può essere facilmente pulita con un panno morbido imbevuto di acqua, anche con detergenti per uso domestico, purché non alcalini ed in genere aggressivi. Evitare l'uso di acidi o basi forti, evitare di strofinare con sostanze o strumenti abrasivi.

# Standard Laminated Surfaces

## 50



Bottom surfaces of our laminated tops are in white, black or dark grey colors. Il fondo del piano laminato può essere con colore bianco, nero o grigio antracite.



For orders under 10no. surcharge 20€ each unit  
Per ordini inferiori ai 10pz + €20,00 ogni unità.

Sizes / Misure	Code / Codice	
60x60 (23 1/2"X23 1/2")	PTL202.__	0.054m³ / 7kg / 1pcs
70x70 (27 1/2"X27 1/2")	PTL204.__	0.074m³ / 9kg / 1pcs
80x80 (31 1/2"X31 1/2")	PTL206.__	0.090m³ / 13kg / 1pcs
90x90 (35 1/2"X35 1/2")	PTL207.__	0.110m³ / 15kg / 1pcs
100x100 (39 1/2"X39 1/2")	PTL228.__	0.200m³ / 16kg / 1pcs
120x80 (47"X31 1/2")	PTL212.__	0.200m³ / 17kg / 1pcs

### ABOUT LAMINATED TABLE TOPS

Gaber's laminate table tops are composed of a high-pressure decorative laminate layer, with a recycled-wood chipboard core and ABS edging. Gaber's support materials are E1 according to tests stipulated by the European standards EN717 and EN120 regarding formaldehyde emission. Laminate tops come ready for Gaber kit bases.

The result is homogeneous, static, lightweight and highly customizable in terms of shapes and finishes.

Our laminate tops are manufactures according the following European Standards related to fire reaction: EN 13501-1:2009 B -s2, d0.

### MAINTENANCE & CLEANING

Gaber laminated table tops do not require any special maintenance beyond normal cleaning.

Laminated surfaces can be easily cleaned with a soft cloth dampened with water, even with cleaning agents, but not alkaline and generally aggressive. Avoid the use of strong acids or bases, avoid wiping with abrasive substances or equipment.

### COSA SONO I PIANI DEI TAVOLI IN LAMINATO?

I ripiani laminati che Gaber utilizza per i propri tavoli sono composti da uno strato di laminato decorativo ad alta pressione, supportato da un pannello di truciolare; quest'ultimo realizzato con i materiali di scarto delle normali lavorazioni del legno. I piani sono bordati con bordo in Abs. La tipologia di supporto utilizzato da Gaber per i propri piani è di classe E1 secondo i test espressi dalle normative europee EN717 e EN120 in materia di emissione di formaldeide. I fissaggi dei ripiani in Laminato sono già predisposti per i basamenti Gaber.

Il risultato è un prodotto omogeneo, antistatico, leggero e facilmente personalizzabile in forme e finiture.

I nostri piani in laminato sono realizzati secondo la normativa europea di reazione al fuoco EN 13501-1:2009 B -s2, d0.

### MANUTENZIONE E PULIZIA

I piani Laminati di Gaber non richiedono alcuna manutenzione particolare al di là della normale pulizia.

La sua superficie può essere facilmente pulita con un panno morbido imbevuto di acqua, anche con detersivi per uso domestico, purché non alcalini ed in genere aggressivi. Evitare l'uso di acidi o basi forti, evitare di strofinare con sostanze o strumenti abrasivi.

# Special Laminated Surfaces

## Wood Effect 25

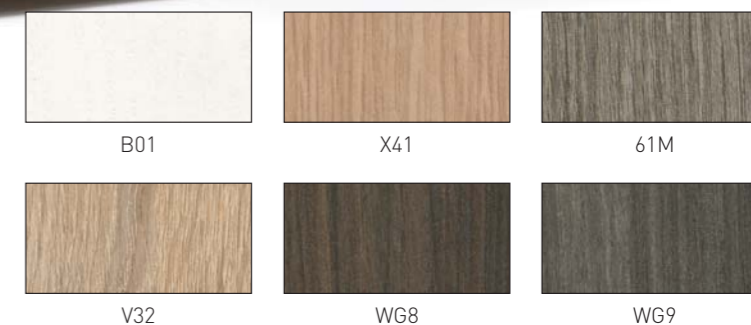
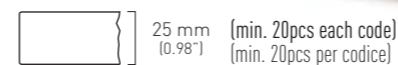

Sizes / Misure	Code / Codice	
Ø 60 (23 1/2")	PTL301.__	0.700m³ / 85kg / 20pcs
Ø 70 (27 1/2")	PTL303.__	0.700m³ / 105kg / 20pcs
Ø 80 (31 1/2")	PTL305.__	0.840m³ / 125kg / 20pcs
Ø 90 (35 1/2")	PTL327.__	0.840m³ / 155kg / 20pcs
Ø 100 (39 1/2")	PTL308.__	1.200m³ / 190kg / 20pcs
Ø 120 (47")	PTL309.__	1.200m³ / 270kg / 20pcs
Ø 140 (55")	PTL315.__	1.600m³ / 325kg / 20pcs
60x60 (23 1/2"X23 1/2")	PTL302.__	0.700m³ / 95kg / 20pcs
70x70 (27 1/2"X27 1/2")	PTL304.__	0.700m³ / 125kg / 20pcs
80x80 (31 1/2"X31 1/2")	PTL306.__	0.840m³ / 160kg / 20pcs
90x90 (35 1/2"X35 1/2")	PTL307.__	0.840m³ / 195kg / 20pcs
100x100 (39 1/2"X39 1/2")	PTL328.__	1.200m³ / 235kg / 20pcs
120x50 (47"X19 1/2")	PTL310.__	0.840m³ / 155kg / 20pcs
120x80 (47"X31 1/2")	PTL312.__	0.840m³ / 235kg / 20pcs
140x70 (55"X27 1/2")	PTL311.__	0.950m³ / 240kg / 20pcs
160x80 (63"X31 1/2")	PTL314.__	1.200m³ / 300kg / 20pcs

### ABOUT LAMINATED TABLE TOPS

Gaber's laminate table tops are composed of a high-pressure decorative laminate layer, with a recycled-wood chipboard core and ABS edging. Gaber's support materials are E1 according to tests stipulated by the European standards EN717 and EN120 regarding formaldehyde emission. Laminate tops come ready for Gaber kit bases.

The result is homogeneous, static, lightweight and highly customizable in terms of shapes and finishes.

To optimize the production process, sizes may vary intollerance ± 5mm.

### MAINTENANCE & CLEANING

Gaber laminated table tops do not require any special maintenance beyond normal cleaning.

Laminated surfaces can be easily cleaned with a soft cloth dampened with water, even with cleaning agents, but not alkaline and generally aggressive. Avoid the use of strong acids or bases, avoid wiping with abrasive substances or equipment.

### COSA SONO I PIANI DEI TAVOLI IN LAMINATO?

I ripiani laminati che Gaber utilizza per i propri tavoli sono composti da uno strato di laminato decorativo ad alta pressione, supportato da un pannello di truciolare; quest'ultimo realizzato con i materiali di scarto delle normali lavorazioni del legno. I piani sono bordati con bordo in Abs. La tipologia di supporto utilizzato da Gaber per i propri piani è di classe E1 secondo i test espressi dalle normative europee EN717 e EN120 in materia di emissione di formaldeide. I fissaggi dei ripiani in Laminato sono già predisposti per i basamenti Gaber.

Il risultato è un prodotto omogeneo, antistatico, leggero e facilmente personalizzabile in forme e finiture.

Ad ottimizzazione delle lavorazioni, le dimensioni possono variare nella tolleranza di ± 5mm.

### MANUTENZIONE E PULIZIA

I piani Laminati di Gaber non richiedono alcuna manutenzione particolare al di là della normale pulizia.

La sua superficie può essere facilmente pulita con un panno morbido imbevuto di acqua, anche con detersivi per uso domestico, purché non alcalini ed in genere aggressivi. Evitare l'uso di acidi o basi forti, evitare di strofinare con sostanze o strumenti abrasivi.







# Special Laminated Surfaces

## Fenix 25

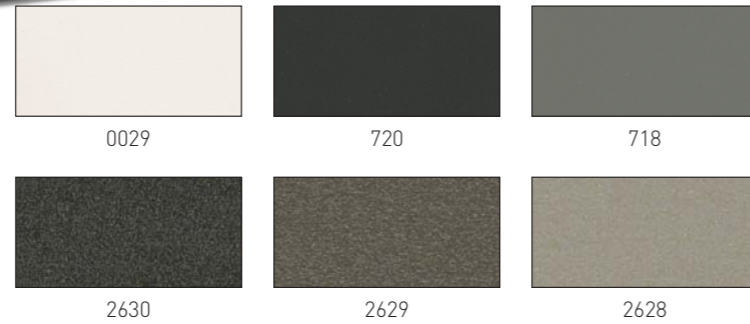

25 mm (0.98") (min. 20pcs each code) (min. 20pcs per codice)



Sizes / Misure	Code / Codice	
	Ø 60 (23 1/2")	PTL401._ 0.700m³ / 85kg / 20pcs
	Ø 70 (27 1/2")	PTL403._ 0.700m³ / 105kg / 20pcs
	Ø 80 (31 1/2")	PTL405._ 0.840m³ / 125kg / 20pcs
	Ø 90 (35 1/2")	PTL427._ 0.840m³ / 155kg / 20pcs
	Ø 100 (39 1/2")	PTL408._ 1.200m³ / 190kg / 20pcs
	Ø 120 (47")	PTL409._ 1.200m³ / 270kg / 20pcs
	Ø 140 (55")	PTL415._ 1.600m³ / 325kg / 20pcs
	60x60 (23 1/2"x23 1/2")	PTL402._ 0.700m³ / 95kg / 20pcs
	70x70 (27 1/2"x27 1/2")	PTL404._ 0.700m³ / 125kg / 20pcs
	80x80 (31 1/2"x31 1/2")	PTL406._ 0.840m³ / 160kg / 20pcs
	90x90 (35 1/2"x35 1/2")	PTL407._ 0.840m³ / 195kg / 20pcs
	100x100 (39 1/2"x39 1/2")	PTL428._ 1.200m³ / 235kg / 20pcs
	120x50 (47"x19 1/2")	PTL410._ 0.840m³ / 155kg / 20pcs
	120x80 (47"x31 1/2")	PTL412._ 0.840m³ / 235kg / 20pcs
	140x70 (55"x27 1/2")	PTL411._ 0.950m³ / 240kg / 20pcs
	160x80 (63"x31 1/2")	PTL414._ 1.200m³ / 300kg / 20pcs

### ABOUT FENIX LAMINATED TABLE TOPS

Gaber's Fenix laminated table tops are composed of a decorative Fenix laminate layer, with a recycled-wood chipboard core. Tops utilize ABS edging, made using nanoparticles and acrylic resins. This coating avoid fingerprints on the material, make it soft-touch, heat-repairing, opaque and extremely resistant to bumps and scratches. In addition to this, the material is water repellent, hygienic, easy to clean and suitable for food-contact. Gaber's support materials are E1 according to tests stipulated by the European standards EN717 and EN120 regarding formaldehyde emission. Laminate tops come ready for Gaber kit bases. To optimize the production process, sizes may vary in tolerance ±5mm.

### MAINTENANCE & CLEANING

Gaber laminated table tops do not require any special maintenance beyond normal cleaning. Laminated surfaces can be easily cleaned with a soft cloth dampened with water, even with cleaning agents, but not alkaline and generally aggressive. Avoid the use of strong acids or bases, avoid wiping with abrasive substances or equipment.

### CHE COSA SONO I PIANI DEI TAVOLI IN LAMINATO FENIX?

I ripiani laminati che Gaber utilizza per i propri tavoli sono composti da uno strato di laminato Fenix decorativo, supportato da un pannello truciolare; quest'ultimo realizzato con i materiali di scarto delle normali lavorazioni del legno. I piani sono bordati in ABS, realizzato per mezzo dell'uso di nanoparticelle e resine acriliche. Tali rivestimenti rendono il materiale anti-impronta, morbido al tatto, termo-riparatore, opaco ed estremamente resistente ad urti e graffi. Oltre a ciò il materiale è idrorepellente, igienico, resistente alle muffe, facile da pulire e adatto al contatto con alimenti. La tipologia di supporto utilizzato da Gaber per i propri piani è di classe E1 secondo i test espressi dalle normative europee EN717 e EN120 in materia di emissione di formaldeide. I fissaggi dei ripiani in laminato sono già predisposti per i basamenti Gaber. Ad ottimizzazione delle lavorazioni, le dimensioni possono variare nella tolleranza di ±5mm.

### MANUTENZIONE E PULIZIA

I piani laminati di Gaber non richiedono alcuna manutenzione particolare al di là della normale pulizia. La sua superficie può essere facilmente pulita con un panno morbido imbevuto di acqua, anche con detersivi per uso domestico, purché non alcalini ed in genere aggressivi. Evitare l'uso di acidi o basi forti, evitare di strofinare con sostanze o strumenti abrasivi.

# Iron Surfaces



25 mm (0.98")



Sizes / Misure	Code / Codice	
60x60 (23 1/2"x23 1/2")	PTI102._	0.054m³ / 16.4kg / 2pcs
70x70 (27 1/2"x27 1/2")	PTI104._	0.074m³ / 21.6kg / 2pcs
80x80 (31 1/2"x31 1/2")	PTI106._	0.090m³ / 22kg / 2pcs
120x80 (47"x31 1/2")	PTI112._	0.20m³ / 31.2kg / 2pcs

### ABOUT IRON TABLE TOPS

Gaber's Iron table tops are made of composite materials: a non-deformable water-repellent multilayer wood-based core, covered in steel. The slim line result is elegant, stylish and practical. Iron tops come pre-bored for Gaber kit bases. These tough materials make iron tops suitable for indoor as well as outdoor use.

### MAINTENANCE & CLEANING

Gaber's Iron table tops do not require any special maintenance beyond normal cleaning. Its surface can be easily cleaned with a soft cloth dampened with water, even with household cleaning detergent, provided they are not alkaline and generally aggressive. Avoid the use of strong acids or bases, avoid rubbing with abrasive substances or devices.

### COSA SONO I PIANI DEI TAVOLI IRON?

I sistemi Iron che Gaber utilizza per i propri piani dei tavoli sono realizzati da materiali compositi: il cuore del sistema è realizzato con un materiale multistrato, a base legnosa, resistente all'umidità, di grande stabilità. Il rivestimento in acciaio e lo spessore contenuto rendono il prodotto elegante, raffinato e pratico. I fissaggi dei piani Iron sono già predisposti per i basamenti Gaber. Le finiture disponibili lo rendono adatto anche all'uso per outdoor, grazie all'ottimale resistenza agli agenti atmosferici.

### MANUTENZIONE E PULIZIA



I piani Iron di Gaber non richiedono alcuna manutenzione particolare al di là della normale pulizia. La sua superficie può essere facilmente pulita con un panno morbido imbevuto di acqua, anche con detersivi per uso domestico, purché non alcalini ed in genere aggressivi. Evitare l'uso di acidi o basi forti, evitare di strofinare con sostanze o strumenti abrasivi.

# Techno Polymer Table Tops



30 mm  
(1,18")



	Sizes / Misure	Code / Codice	
	Ø 60 (23 ½")	PTT04_	0.054m³ / 4kg / 1pcs
	Ø 72 (28 ½")	PTT03_	0.074m³ / 4.7kg / 1pcs
	60x60 (23 ½"X23 ½")	PTT20_	0.054m³ / 4.8kg / 1pcs
	72x72 (28 ½"X28 ½")	PTT06_	0.074m³ / 6kg / 1pcs
	80x80 (31 ½"X31 ½")w	PTT23_	0.090m³ / 8.6kg / 1pcs

## ABOUT TECHNO POLYMER TABLE-TOPS

The Techno Polymer Compounds Gaber uses on its table tops have high structural, heat and abrasion resistance. Gaber's technopolymer table tops are practical, shock-resistant, colorful and inexpensive.

Gaber technopolymers are non-toxic, stain-resistant, antistatic and UV-resistant and consequently have excellent resistance to atmospheric agents. All these materials are recyclable in the full respect of our Natural Environment. Gaber produces plastic injected materials without added chemicals and, as far as possible, recycled pre-used technopolymers are sourced as a base raw material. Technopolymer table top colors perfectly match the colors of Gaber's seating collection.

## MAINTENANCE & CLEANING

The plastic surfaces of Gaber products can generally be cleaned with a cloth and warm water. For the most persistent stains, a small amount of liquid soap diluted in water may be used. Do not use acetone, trichloroethylene, ammonia, alcoholic substances and detergents that contain even just a small amount of these substances. We also recommend avoiding all types of abrasive and solvent substances or rough sponges.

## COME SONO FATTI I RIPIANI IN TECNOPOLIMERO?

I piani in Tecnopolimero utilizzati da Gaber per i propri tavoli sono realizzati per mezzo del processo di iniezione plastica. I piani così realizzati sono pratici, resistenti agli urti, colorati ed economici. I compound di tecnopolimeri utilizzati da Gaber nella realizzazione dei propri prodotti sono caratterizzati da un'elevata resistenza strutturale, termica e all'abrasione. Il tecnopolimero è atossico, antimacchia, antistatico e anti-uv: qualità che lo rendono ottimamente resistente agli agenti atmosferici. I tecnopolimeri utilizzati da Gaber sono integralmente riciclabili, nel pieno rispetto del nostro Ambiente Naturale. Gaber produce articoli termoplastici senza additivi chimici e, ove possibile, vengono utilizzati tecnopolimeri riciclati derivanti da post-consumo. I colori dei ripiani dei tavoli corrispondono ai colori della vasta collezione di sedute Gaber.

## MANUTENZIONE E PULIZIA

Le superfici in tecno polimero dei piani dei tavoli Gaber possono essere pulite con un panno umido e soffice imbevuto in acqua. Per le macchie più ostinate è possibile diluire in acqua del sapone neutro liquido con moderazione. Non utilizzare acetone, trielina, ammoniaca, sostanze alcoliche o detersivi che contengano anche piccole quantità di tali detersivi. Non utilizzare a contatto con il prodotto sostanze abrasive o solventi, strumenti di pulizia ruvidi.

# TABLE BASES Collection





## ARKET 3 BASE

H49-H73-H109 3 spur aluminum casted base, column made in aluminum extruded tube, aluminum cross and adjustable feet. Basamento per tavolo H49-H73-H109 con 3 razze e crociera in alluminio pressofuso, colonna in alluminio estruso. Piedini regolabili.



Top max dimensions / Massima dimensione piano



Available table tops / Piani tavolo disponibili

compactop laminated

Frame Color / Colore Struttura



H49	BAK3B_		0.055m³ / 3.5kg / 1pcs
H73	BAK3_		0.055m³ / 4.0kg / 1pcs
H109	BAK3A_		0.085m³ / 4.2kg / 1pcs

Minimum order 20 pcs each code, unless combined with Gaber table tops. Ordine minimo 20 pezzi per codice, se non abbinato a piani Gaber.

## ARKET 4 BASE

H49-H73-H109 4 spur aluminum casted base, column made in aluminum extruded tube, aluminum cross and adjustable feet. Basamento per tavolo H49-H73-H109 con 4 razze e crociera in alluminio pressofuso, colonna in alluminio estruso. Piedini regolabili.



Top max dimensions / Massima dimensione piano

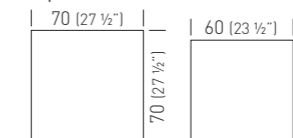

Available table tops / Piani tavolo disponibili

compactop laminated

Frame Color / Colore Struttura



H49	BAK4B_		0.055m³ / 4.2kg / 1pcs
H73	BAK4_		0.055m³ / 4.5kg / 1pcs
H109	BAK4A_		0.085m³ / 4.8kg / 1pcs

Minimum order 20 pcs each code, unless combined with Gaber table tops. Ordine minimo 20 pezzi per codice, se non abbinato a piani Gaber.

## ARKET PLUS

H73 3 spur metal-technopolymer co-injected table base, aluminum column and cross, flip-top mechanism. Base per tavolo pieghevole H73 a tre razze in metallo sovrastampato con tecnopolimero, colonna e crociera in alluminio.

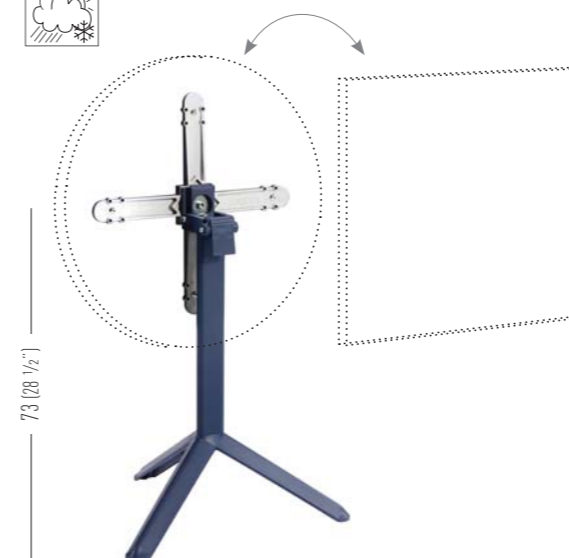

Top max dimensions / Massima dimensione piano

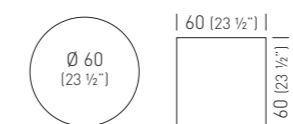

Available table tops / Piani tavolo disponibili

compactop laminated

Frame Color / Colore Struttura



BAKP_		0.12m³ / 5.5kg / 1pc
-------	--	----------------------





## BG3K

H73 3-spur metal-technopolymer co-injected table base, Ø 80mm anodized aluminum column with cross.  
 Base per tavolo H73 a tre razze in metallo sovrastampato con tecnopolimero, colonna in alluminio anodizzato Ø 80mm, crociera.

Top max dimensions / Massima dimensione piano

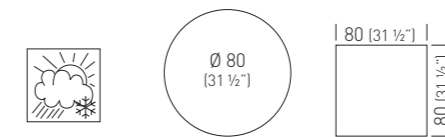

Available table tops / Piani tavolo disponibili

compactop  
laminated  
iron

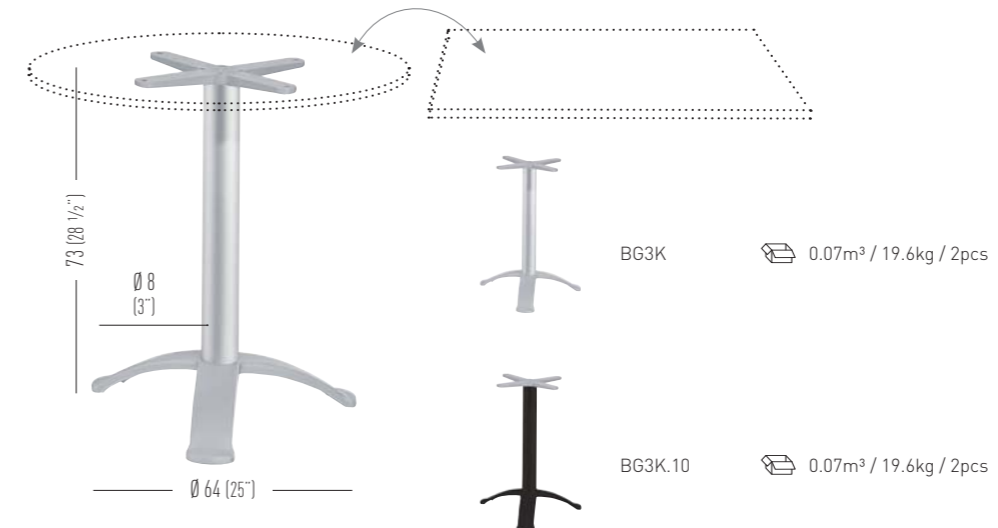

## BGA3K

H115 3-spur metal-technopolymer co-injected table base, Ø 80mm anodized aluminum column with cross.  
 Base per tavolo H115 a tre razze in metallo sovrastampato con tecnopolimero, colonna in alluminio anodizzato Ø 80mm, crociera.

Top max dimensions / Massima dimensione piano

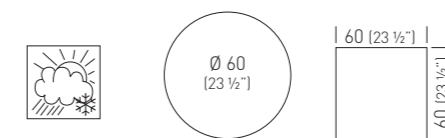

Available table tops / Piani tavolo disponibili

compactop  
laminated  
iron

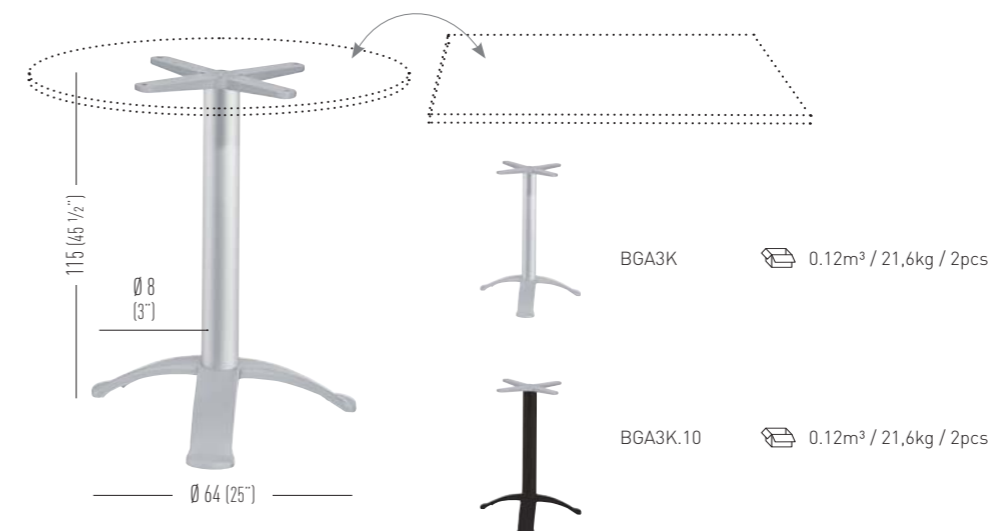





# BPG3K

H73 3-spur metal-technopolymer co-injected table base, Ø 60mm anodized aluminum column with cross.  
 Base per tavolo H73 a tre razze in metallo sovrastampato con tecnopolimero, colonna in alluminio anodizzato Ø 60mm, crociera.



Top max dimensions / Massima dimensione piano

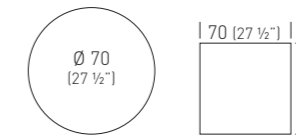

Available table tops / Piani tavolo disponibili

compactop  
laminated  
iron

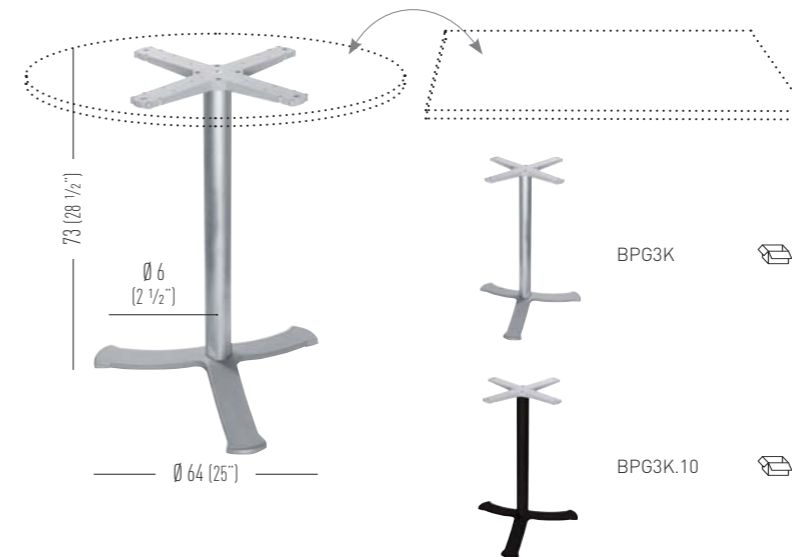

BPG3K 0.07m³ / 14.20kg / 2pcs

BPG3K.10 0.07m³ / 14.20kg / 2pcs





## BG3L

H73 3-spur metal-technopolymer co-injected table base, Ø 80mm anodized aluminum column with cross.  
 Base per tavolo H73 a tre razze in metallo sovrastampato con tecnopolimero, colonna in alluminio anodizzato Ø 80mm, crociera.

Top max dimensions / Massima dimensione piano

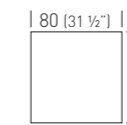

Available table tops / Piani tavolo disponibili

compactop  
laminated  
iron

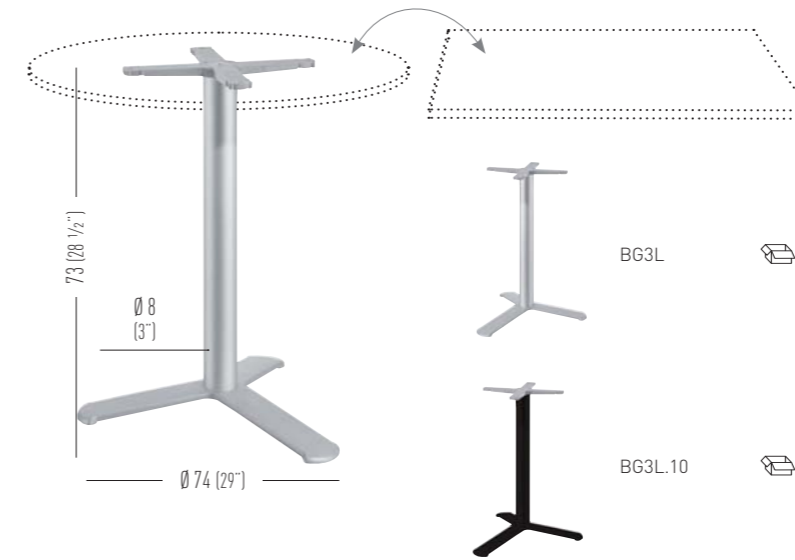

BG3L 0.08m<sup>3</sup> / 11kg / 1pcs

BG3L.10 0.08m<sup>3</sup> / 11kg / 1pcs

## BGA3L

H110 3-spur metal-technopolymer co-injected table base, Ø 80mm anodized aluminum column with cross.  
 Base per tavolo H110 a tre razze in metallo sovrastampato con tecnopolimero, colonna in alluminio anodizzato Ø 80mm, crociera.

Top max dimensions / Massima dimensione piano

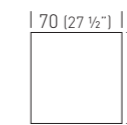
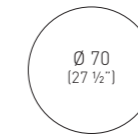

Available table tops / Piani tavolo disponibili

compactop  
laminated  
iron

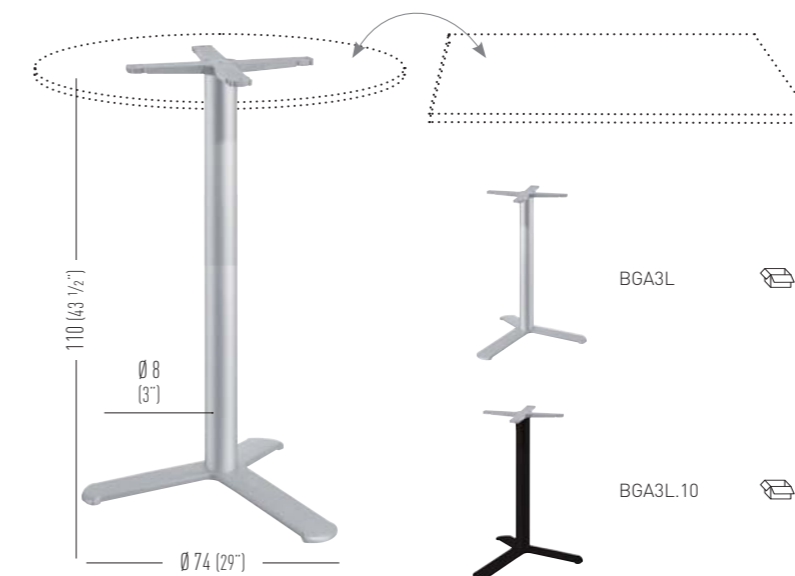

BGA3L 0.12m<sup>3</sup> / 23.6kg / 2pcs

BGA3L.10 0.12m<sup>3</sup> / 23.6kg / 2pcs





## BG4K

H73 4-spur metal-technopolymer co-injected table base, Ø 80mm anodized aluminum column with cross.  
 Base per tavolo H73 a quattro razze in metallo sovrastampato con tecnopolimero, colonna in alluminio anodizzato Ø 80mm, crociera.

Top max dimensions / Massima dimensione piano

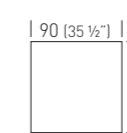
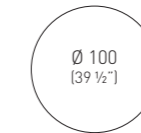

Available table tops / Piani tavolo disponibili

compactop  
laminated  
iron

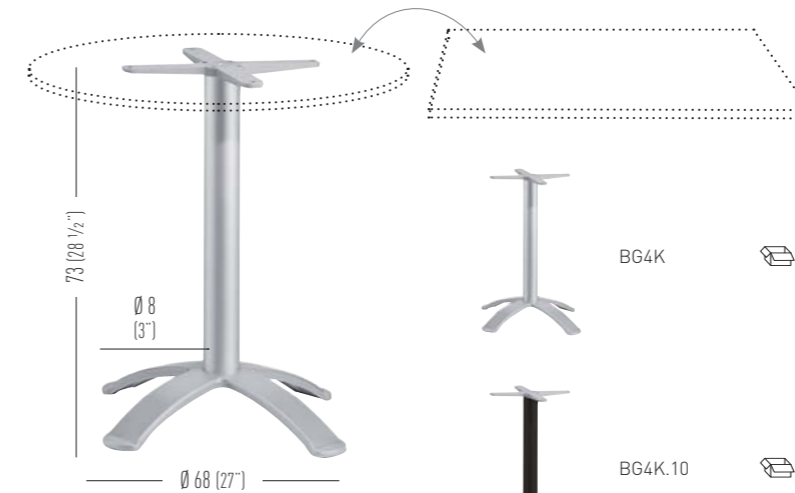

BG4K 0.07m³ / 25kg / 2pcs

BG4K.10 0.07m³ / 25kg / 2pcs

## BG4J

H73 4-spur metal-technopolymer co-injected table base, 80x80mm anodized aluminum column with cross.  
 Base per tavolo H73 a quattro razze in metallo sovrastampato con tecnopolimero, colonna in alluminio anodizzato 80x80mm, crociera.

Top max dimensions / Massima dimensione piano

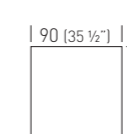
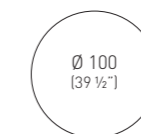

Available table tops / Piani tavolo disponibili

compactop  
laminated  
iron

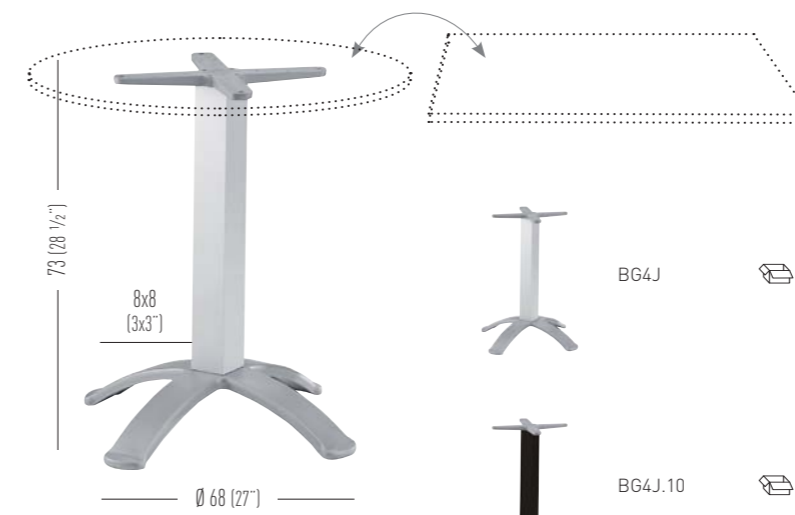

BG4J 0.10m³ / 25.6kg / 2pcs

BG4J.10 0.10m³ / 25.6kg / 2pcs

# BGPK

H73 4-spur metal-technopolymer co-injected table base, Ø 80mm anodized aluminum column with flip-top mechanism.

Base per tavolo pieghevole H73 a quattro razze in metallo sovrastampato con tecnopolimero, colonna in alluminio anodizzato Ø 80mm.



Top max dimensions / Massima dimensione piano

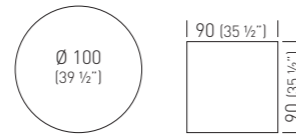

Available table tops / Piani tavolo disponibili

compactop  
laminated  
iron

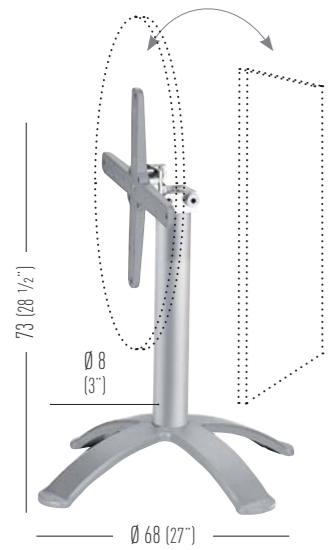

BGPK 0.07m³ / 27kg / 2pcs

BGPK.10 0.07m³ / 27kg / 2pcs

# BGA4K

H115 4-spur metal-technopolymer co-injected table base, Ø 80mm anodized aluminum column with cross.

Base per tavolo H115 a quattro razze in metallo sovrastampato con tecnopolimero, colonna in alluminio anodizzato Ø 80mm, crociera.



Top max dimensions / Massima dimensione piano

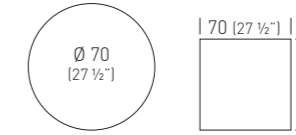

Available table tops / Piani tavolo disponibili

compactop  
laminated  
iron

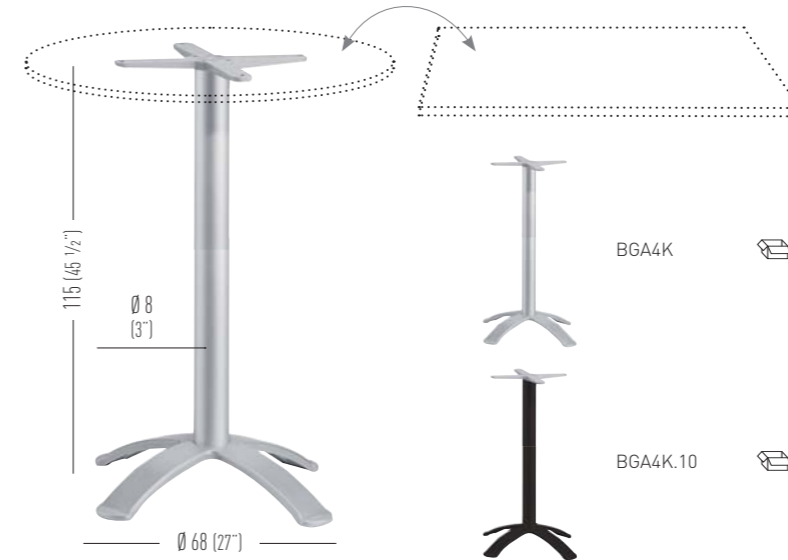

BGA4K 0.11m³ / 26.60kg / 2pcs

BGA4K.10 0.11m³ / 26.60kg / 2pcs

# BGPJ

H73 4-spur metal-technopolymer co-injected table base, 80x80mm anodized aluminum column with flip-top mechanism.

Base per tavolo pieghevole H73 a quattro razze in metallo sovrastampato con tecnopolimero, colonna in alluminio anodizzato 80x80mm.



Top max dimensions / Massima dimensione piano



Available table tops / Piani tavolo disponibili

compactop  
laminated  
iron

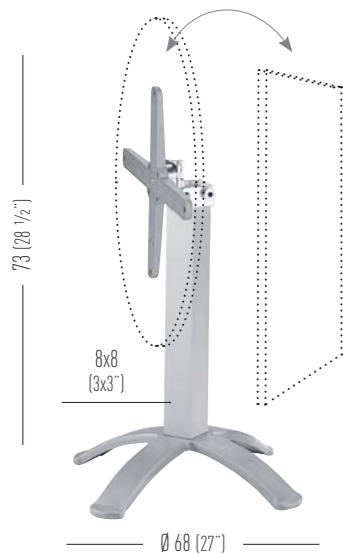

BGPJ 0.10m³ / 27.60kg / 2pcs

BGPJ.10 0.10m³ / 27.60kg / 2pcs





## BPG4K

H73 4-spur metal-technopolymer co-injected table base, Ø 60mm anodized aluminum column with cross.  
 Base per tavolo H73 a quattro razze in metallo sovrastampato con tecnopolimero, colonna in alluminio anodizzato Ø 60mm, crociera.



Top max dimensions / Massima dimensione piano



Available table tops / Piani tavolo disponibili

compactop  
 laminated  
 iron

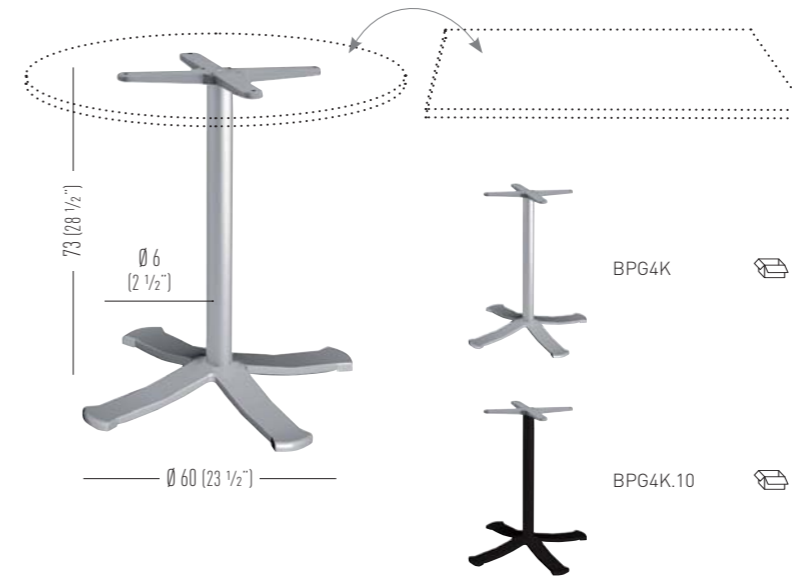

BPG4K 0.07m³ / 17kg / 2pcs

BPG4K.10 0.07m³ / 17kg / 2pcs





## BG4IP

H73 stacking 4-spur metal-technopolymer co-injected table base, Ø 80mm round anodized aluminum column with flip-top mechanism. Adjustable feet. Base per tavolo pieghevole e accatastabile H73 a quattro razze in metallo sovrastampato con tecnopolimero, colonna in alluminio anodizzato Ø 80mm. Piedini regolabili.



Top max dimensions / Massima dimensione piano

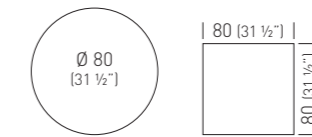

Available table tops / Piani tavolo disponibili

compactop  
laminated  
iron

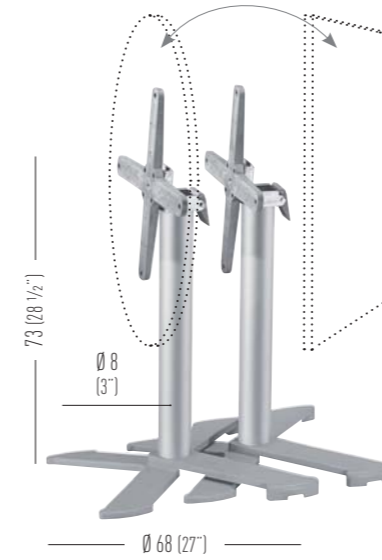

BG4IP 0.07m³ / 20kg / 2pcs



BG4IP.10 0.07m³ / 20kg / 2pcs





## BG2J

H73 double metal-technopolymer co-injected table base, 80x80mm anodized aluminum column with cross. Base doppia per tavolo H73 in metallo sovrastampato con tecnopolimero, colonna in alluminio anodizzato 80x80mm, crociera.

Top max dimensions / Massima dimensione piano

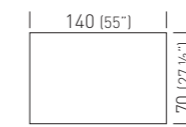

Available table tops / Piani tavolo disponibili

compactop  
laminated  
iron

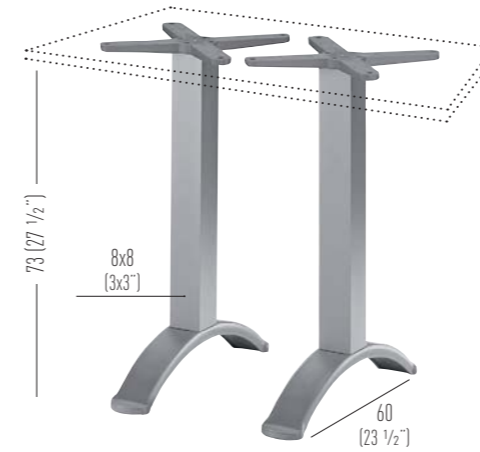

BG2J

0.07m³ / 30kg / 2pcs



BG2J.10

0.07m³ / 30kg / 2pcs



## BTK

H73 round metal-technopolymer co-injected table base, Ø 80mm anodized aluminum column with cross.  
 Base per tavolo H73 rotonda in metallo sovrastampato con tecnopolimero, colonna in alluminio anodizzato Ø 80mm, crociera.

Top max dimensions / Massima dimensione piano



Available table tops / Piani tavolo disponibili

compactop  
laminated  
iron

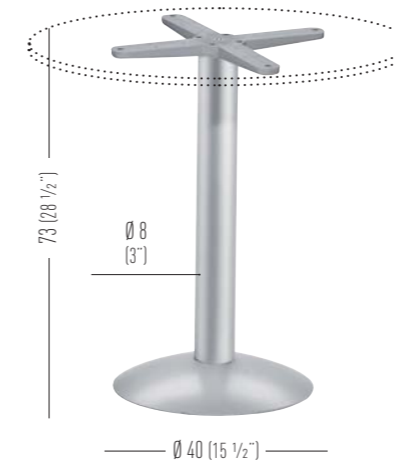

BTK 0.10m³ / 19.60kg / 2pcs

BTK.10 0.10m³ / 19.60kg / 2pcs

## BTAK

H110 round metal-technopolymer co-injected table base, Ø 80mm anodized aluminum column with cross.  
 Base per tavolo H110 rotonda in metallo sovrastampato con tecnopolimero, colonna in alluminio anodizzato Ø 80mm, crociera.

Top max dimensions / Massima dimensione piano



Available table tops / Piani tavolo disponibili

compactop  
laminated  
iron

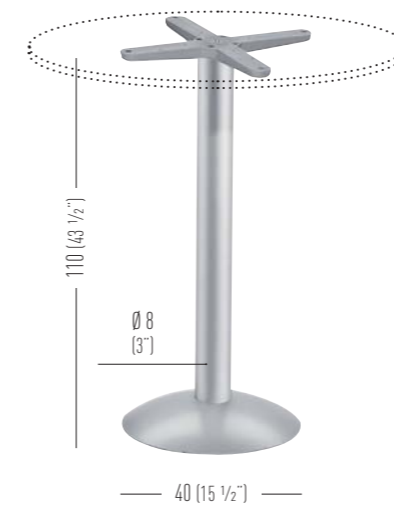

BTAK 0.11m³ / 21.60kg / 2pcs

BTAK.10 0.11m³ / 21.60kg / 2pcs





## BTK54

H73 round metal-technopolymer co-injected table base, Ø 80mm anodized aluminum column with cross. Base per tavolo H73 rotonda in metallo sovrastampato con tecnopolimero, colonna in alluminio anodizzato Ø 80mm, crociera.

Top max dimensions / Massima dimensione piano

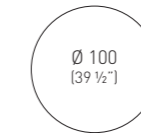

Available table tops / Piani tavolo disponibili

compactop  
laminated  
iron

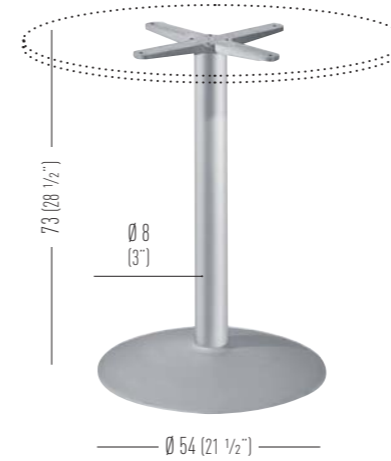

BTK54 0.10m³ / 24.60kg / 2pcs

BTK54.10 0.10m³ / 24.60kg / 2pcs

## BTAK54

H110 round metal-technopolymer co-injected table base, Ø 80mm anodized aluminum column with cross. Base per tavolo H110 rotonda in metallo sovrastampato con tecnopolimero, colonna in alluminio anodizzato Ø 80mm, crociera.

Top max dimensions / Massima dimensione piano



Available table tops / Piani tavolo disponibili

compactop  
laminated  
iron

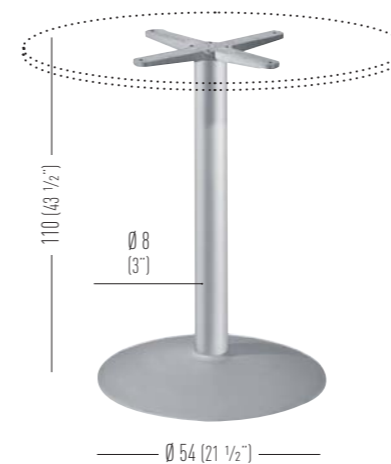

BTAK54 0.11m³ / 25.60kg / 2pcs

BTAK54.10 0.11m³ / 25.60kg / 2pcs





## BRCV

H73 round metal-techno-polymer co-injected table base, Ø 50mm metal painted column with cross.  
 Base per tavolo H73 rotonda in metallo sovrastampato con tecnopolimero, colonna in metallo verniciato Ø 50mm, crociera.



Top max dimensions / Massima dimensione piano

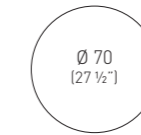

Available table tops / Piani tavolo disponibili

compactop  
 laminated  
 iron

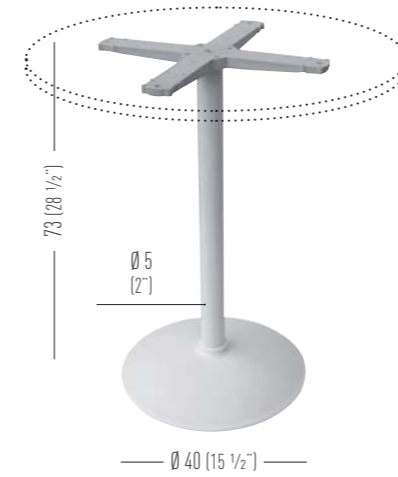

BRCV  0.07m³ / 15kg / 2pcs



BRCV.10  0.07m³ / 15kg / 2pcs





## VENUS ROUND

H73 metal-technopolymer co-injected table base.  
 Base per tavolo H73 rotonda in metallo sovrastampato con tecnopolimero.



Top max dimensions / Massima dimensione piano



Available table tops / Piani tavolo disponibili

compactop  
 laminated  
 iron

Additional weight on request (+3).  
 Peso supplementare disponibile su richiesta (+3).



BGVR.00  0.2m³ / 6kg / 1pcs  
 BGVR.00+3kg  0.2m³ / 9kg / 1pcs





# VENUS SQUARE

H73 metal-technopolymer  
co-injected table base.  
Base per tavolo H73 quadrata  
in metallo sovrastampato con  
tecnopolimero.

Top max dimensions / Massima dimensione piano

Available table tops / Piani tavolo disponibili

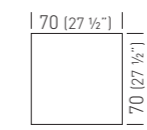

compactop  
laminated  
iron

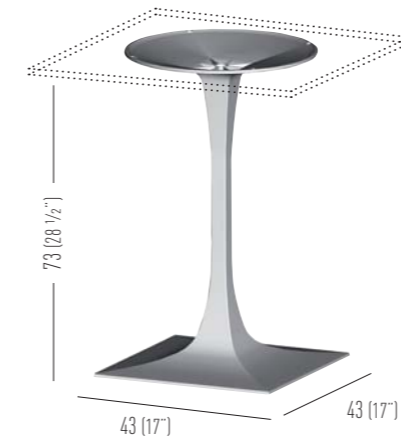

BGVQ.00

0.2m³ / 7kg / 1pcs





# BRK

H73 round metal-technopolymer co-injected table base, Ø 80mm anodized aluminum column with cross.  
 Base per tavolo H73 rotonda in metallo sovrastampato con tecnopolimero, colonna in alluminio anodizzato Ø 80mm, crociera.



Top max dimensions / Massima dimensione piano

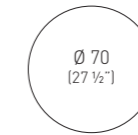

Available table tops / Piani tavolo disponibili

compactop  
laminated  
iron

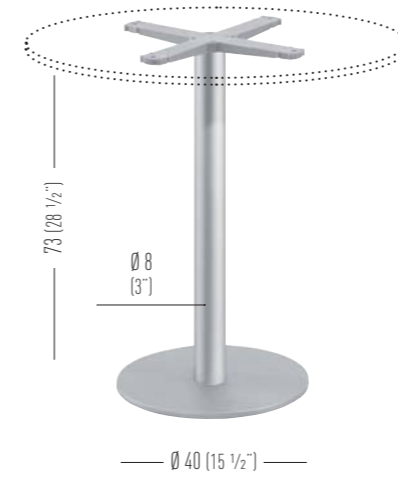

BRK 0.07m³ / 20.60kg / 2pcs

BRK.10 0.07m³ / 20.60kg / 2pcs





## BQJ

H73 square metal-technopolymer co-injected table base, 80x80mm anodized aluminum column with cross.  
 Base per tavolo H73 quadrata in metallo sovrastampato con tecnopolimero, colonna in alluminio anodizzato 80x80mm, crociera.

Top max dimensions / Massima dimensione piano

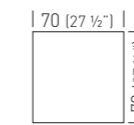

Available table tops / Piani tavolo disponibili

compactop  
laminated  
iron

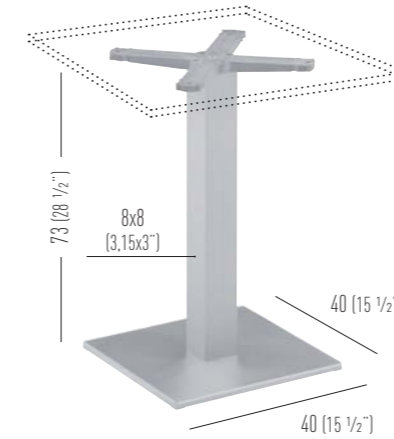

BQJ 0.07m³ / 24.60kg / 2pcs

BQJR 0.07m³ / 24.60kg / 2pcs  
Adjustable feet / Piedini regolabili



BQJ.10 0.07m³ / 24.60kg / 2pcs

BQJR.10 0.07m³ / 24.60kg / 2pcs  
Adjustable feet / Piedini regolabili

## BQAJ

H103 square metal-technopolymer co-injected table base, 80x80mm square anodized aluminum column with cross.  
 Base per tavolo H103 quadrata in metallo sovrastampato con tecnopolimero, colonna quadrata in alluminio anodizzato 80x80mm, crociera.

Top max dimensions / Massima dimensione piano

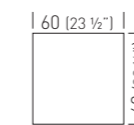

Available table tops / Piani tavolo disponibili

compactop  
laminated  
iron

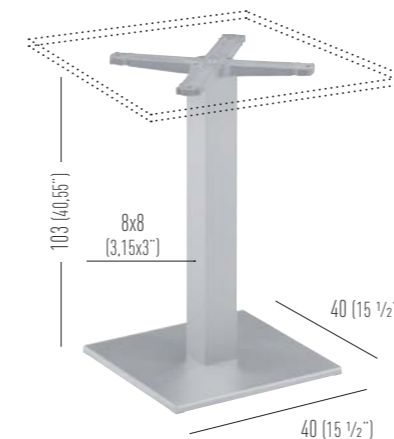

BQAJ 0.08m³ / 25.60kg / 2pcs

BQAJR 0.08m³ / 25.60kg / 2pcs  
Adjustable feet / Piedini regolabili



BQAJ.10 0.08m³ / 25.60kg / 2pcs

BQAJR.10 0.08m³ / 25.60kg / 2pcs  
Adjustable feet / Piedini regolabili





# L0L3 BASE

H49-H74 3-spur table base collection, made of steel treated for outdoor use, matt finish.  
 Basamento per tavolo H49-H74 a tre razze, realizzato in acciaio trattato per esterni, finitura opaca.



Only for the base  
 Solo per il basamento

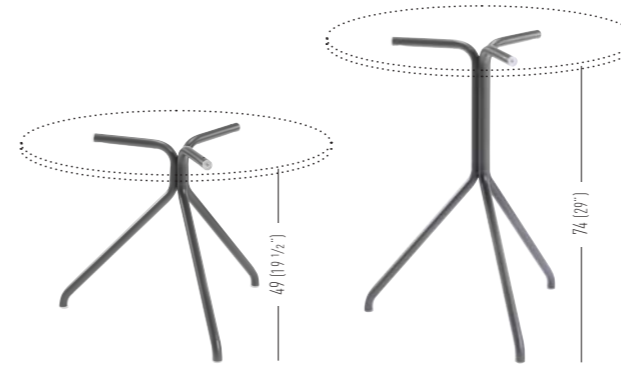

Only for the base  
 Solo per il basamento

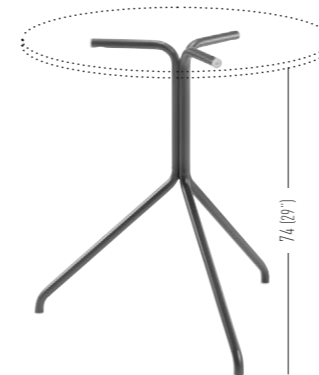

Top max dimensions / Massima dimensione piano



Available table tops / Piani tavolo disponibili  
 laminated

Frame Color / Colore Struttura



H49 BLOL3.\_/H49 0.17m³ / 3.5kg / 1pc  
 H74 BLOL3.\_/H74 0.24m³ / 4.1kg / 1pc

Top max dimensions / Massima dimensione piano



Available table tops / Piani tavolo disponibili  
 laminated

Frame Color / Colore Struttura



H74L BLOL3L.\_/H74 0.43m³ / 4.2Kg / 1pc

# LOL4 BASE

H74 4-spur table base collection, made of steel treated for outdoor use, matt finish. Basamento per tavolo H74 a quattro razze, realizzato in acciaio trattato per esterni, finitura opaca.

Top max dimensions / Massima dimensione piano

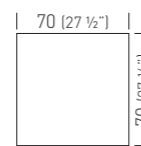

Available table tops / Piani tavolo disponibili

compactop laminated

Frame Color / Colore Struttura



H74 BLOL4\_/H74 0.24m³ / 4.9kg / 1pc

Top max dimensions / Massima dimensione piano

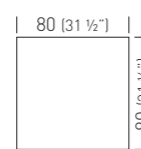

Available table tops / Piani tavolo disponibili

compactop laminated

Frame Color / Colore Struttura



H74L BLOL4L\_/H74 0.35m³ / 5.2kg / 1pc



Only for the base  
Solo per il basamento

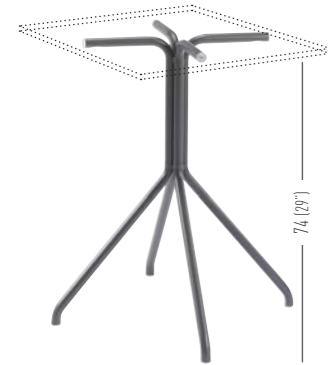

Only for the base  
Solo per il basamento



# LOL PLUS BASE

The Lol Plus table bases collection is made of steel, the cross is made in die cast aluminum, and provided with flip-top joint. The shape of the base and the flip-top mechanism allow the table to easily fold and stack, space-saving. The available colour palette is common to many Gaber seating collections, guaranteeing tone-on-tone colour co-ordination throughout designed settings rather than lively contrasts, defining various colour combinations between bases, tops and seating.

La Collezione di basamenti Lol Plus è realizzata in acciaio, la crociera è realizzata in presso fusione di alluminio, ed è dotata di giunto per la rotazione del piano. La forma della base e la meccanica che permette la rotazione del piano in posizione verticale, rendono il tavolo facilmente accatastabile in spazi ridotti. La palette di colori disponibile è comune a molte collezioni di sedute Gaber, garantendo abbinamenti tono su tono degli ambienti progettati, piuttosto che vivaci contrasti, definendo diverse combinazioni di colori tra basi, piani e sedute.

Top max dimensions / Massima dimensione piano

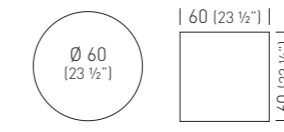

Available table tops / Piani tavolo disponibili

compactop laminated

Frame Color / Colore Struttura



H74 BLOLP\_/H74 0.24m³ / 5.3kg / 1pc



Only for the base  
Solo per il basamento

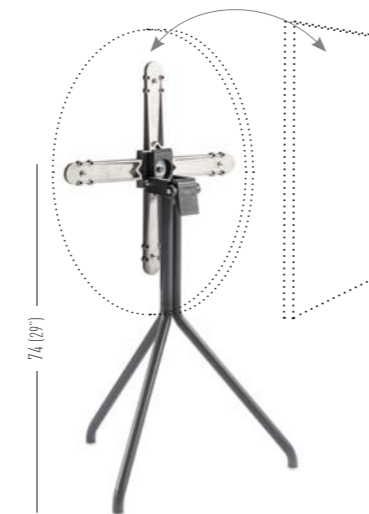



# BRISTOL BASE

4-spur H74 table base in epoxy powder coated steel treated for outdoor use, and equipped with adjustable feet.

Basamento per tavolo H74 con struttura a quattro razze, dotato di piedini regolabili, in acciaio verniciato a polveri epossidiche con trattamento per esterno.

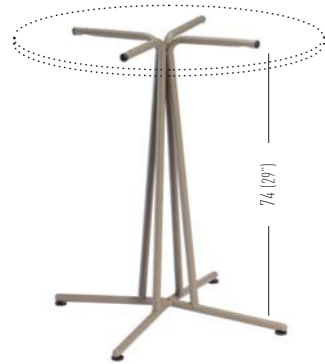

Top max dimensions / Massima dimensione piano

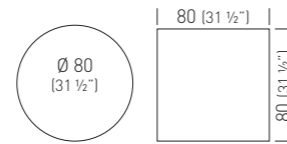

Available table tops / Piani tavolo disponibili

compactop  
laminated

Frame Color / Colore Struttura



H74 BBR.\_/H74 0.23m<sup>3</sup> / 7.5kg / 1pc

Minimum order 20 pcs each code, unless combined with Gaber table tops.  
Ordine minimo 20 pezzi per codice, se non abbinato a piani Gaber.

# GLITTER BASE

H74 and H105 tripod table bases in epoxy powder coated steel with outdoor treatment.

Basamento per tavolo H74-H105 con struttura a tre punti di appoggio, realizzato in acciaio verniciato a polveri epossidiche con trattamento per esterno.



Top max dimensions / Massima dimensione piano

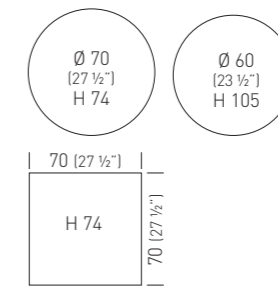

Available table tops / Piani tavolo disponibili

compactop  
laminated

Frame Color / Colore Struttura



H74 BGLT.\_/H74 0.18m<sup>3</sup> / 4.9kg / 1pc  
H105 BGLT.\_/H105 0.18m<sup>3</sup> / 5.6kg / 1pc

Minimum order 20 pcs each code, unless combined with Gaber table tops.  
Ordine minimo 20 pezzi per codice, se non abbinato a piani Gaber.



# LEI

H73 or H110 4-spur metal-technopolymer co-injected table base, Ø 60mm anodized aluminum column with cross.

Base per tavolo H73 o H110 a quattro razze in metallo sovrastampato con tecnopolimero, colonna in alluminio anodizzato Ø 60mm, crociera.

Top max dimensions / Massima dimensione piano

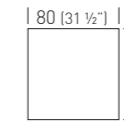
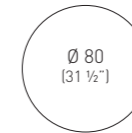

Only H110 / Solo H110

Available table tops / Piani tavolo disponibili

compactop  
laminated  
iron

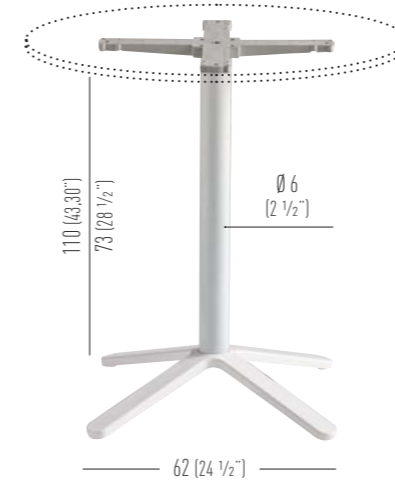

BLEI.00 0.07m³ / 8.5kg / 1pcs

BLEIA.00 0.09m³ / 9kg / 1pcs



BLEI.10 0.07m³ / 8.5kg / 1pcs

BLEIA.10 0.09m³ / 9kg / 1pcs





# AMICA

H73 4-spur table base collection made of die-cast painted aluminum, Ø60mm polymer-steel co-injected column with cross. Adjustable feet.  
 Collezione basamenti per tavoli H73 a quattro razze in alluminio pressofuso verniciato, colonna in metallo-polimero Ø60mm, con crociera. Piedini regolabili.



Available table tops / Piani tavolo disponibili

compactop  
laminated  
iron

Top max dimensions / Massima dimensione piano

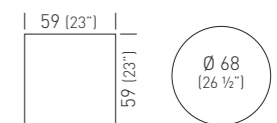

BDA1.00 0.07m<sup>3</sup> / 6.5kg / 1pcs

BDA1.10 0.07m<sup>3</sup> / 6.5kg / 1pcs

ADJUSTABLE FEET  
PIEDINI REGOLABILI

Top max dimensions / Massima dimensione piano

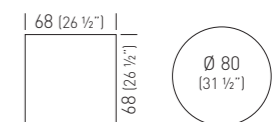

BDA2.00 0.07m<sup>3</sup> / 7kg / 1pcs

BDA2.10 0.07m<sup>3</sup> / 7kg / 1pcs

ADJUSTABLE FEET  
PIEDINI REGOLABILI

Top max dimensions / Massima dimensione piano

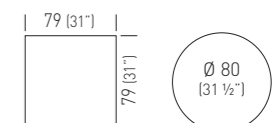

BDA3.00 0.08m<sup>3</sup> / 8kg / 1pcs

BDA3.10 0.08m<sup>3</sup> / 8kg / 1pcs

ADJUSTABLE FEET  
PIEDINI REGOLABILI





## R1

H50-H74-H110 round steel table base,  
 Ø 80mm steel column with cross.  
 Base per tavolo rotonda in acciaio  
 H50, H74 e H110, colonna in acciaio Ø  
 80mm, crociera.

Top max dimensions / Massima dimensione piano

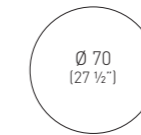

Available table tops / Piani tavolo disponibili

compactop  
 laminated  
 iron



Finishes for R bases / Finiture per basamenti serie R

Polished Steel-Chromed Column / Acciaio Lucido-Colonna Cromata

Ø 80	H50	BAR1B.A	0.07m³ / 15kg / 1pcs
	H74	BAR1.A	0.07m³ / 15kg / 1pcs
	H110	BAR1A.A	0.09m³ / 17kg / 1pcs

Satin Steel-Satin Column / Acciaio Satinato-Colonna Satinata

Ø 80	H50	BAR1B.S	0.07m³ / 15kg / 1pcs
	H74	BAR1.S	0.07m³ / 15kg / 1pcs
	H110	BAR1A.S	0.09m³ / 17kg / 1pcs

White Painted / Verniciata Bianca

Ø 80	H50	BAR1B.00	0.07m³ / 15kg / 1pcs
	H74	BAR1.00	0.07m³ / 15kg / 1pcs
	H110	BAR1A.00	0.09m³ / 17kg / 1pcs

Black Painted / Verniciata Nera

Ø 80	H50	BAR1B.10	0.07m³ / 15kg / 1pcs
	H74	BAR1.10	0.07m³ / 15kg / 1pcs
	H110	BAR1A.10	0.09m³ / 17kg / 1pcs

## R2

H50-H74-H110 round steel table base,  
 Ø 80mm steel column with cross.  
 Base per tavolo rotonda in acciaio  
 H50, H74 e H110, colonna in acciaio Ø  
 80mm, crociera.

Top max dimensions / Massima dimensione piano



Available table tops / Piani tavolo disponibili

compactop  
 laminated  
 iron

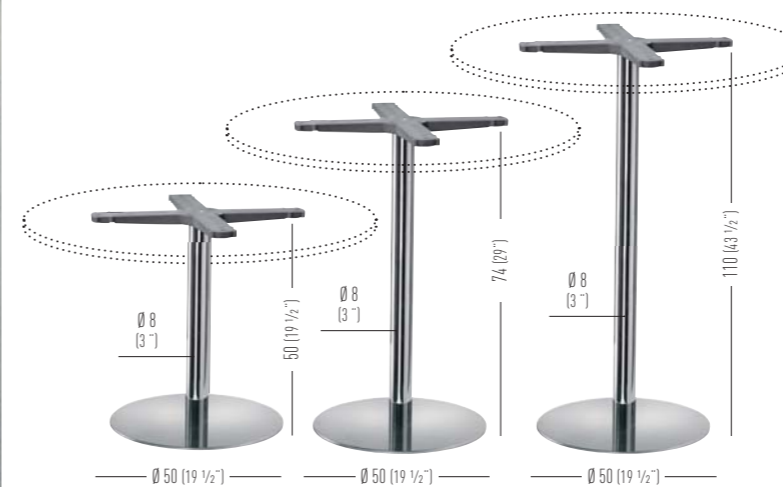

Finishes for R bases / Finiture per basamenti serie R

Polished Steel-Chromed Column / Acciaio Lucido-Colonna Cromata

Ø 80	H50	BAR2B.A	0.07m³ / 18kg / 1pcs
	H74	BAR2.A	0.07m³ / 18kg / 1pcs
	H110	BAR2A.A	0.09m³ / 20kg / 1pcs

Satin Steel-Satin Column / Acciaio Satinato-Colonna Satinata

Ø 80	H50	BAR2B.S	0.07m³ / 18kg / 1pcs
	H74	BAR2.S	0.07m³ / 18kg / 1pcs
	H110	BAR2A.S	0.09m³ / 20kg / 1pcs

White Painted / Verniciata Bianca

Ø 80	H50	BAR2B.00	0.07m³ / 18kg / 1pcs
	H74	BAR2.00	0.07m³ / 18kg / 1pcs
	H110	BAR2A.00	0.09m³ / 20kg / 1pcs

Black Painted / Verniciata Nera

Ø 80	H50	BAR2B.10	0.07m³ / 18kg / 1pcs
	H74	BAR2.10	0.07m³ / 18kg / 1pcs
	H110	BAR2A.10	0.09m³ / 20kg / 1pcs



# R3

H74-H110 round steel table base,  
 Ø 80mm round steel column with cross.  
 Base per tavolo rotonda in acciaio H74 e  
 H110, colonna rotonda in acciaio  
 Ø 80mm, crociera.

Top max dimensions / Massima dimensione piano



Available table tops / Piani tavolo disponibili

compactop  
 laminated  
 iron

Finishes for R bases / Finiture per basamenti serie R

Polished Steel-Chromed Column / Acciaio Lucido-Colonna Cromata

●	H74	BAR3.A	0.07m <sup>3</sup> / 21kg / 1pcs
●	H110	BAR3A.A	0.09m <sup>3</sup> / 23kg / 1pcs

Satin Steel-Satin Column / Acciaio Satinato-Colonna Satinata

●	H74	BAR3.S	0.07m <sup>3</sup> / 21kg / 1pcs
●	H110	BAR3A.S	0.09m <sup>3</sup> / 23kg / 1pcs

White Painted / Verniciata Bianca

○	H74	BAR3.00	0.07m <sup>3</sup> / 21kg / 1pcs
○	H110	BAR3A.00	0.09m <sup>3</sup> / 23kg / 1pcs

Black Painted / Verniciata Nera

●	H74	BAR3.10	0.07m <sup>3</sup> / 21kg / 1pcs
●	H110	BAR3A.10	0.09m <sup>3</sup> / 23kg / 1pcs



# T1 FLOOR FIXING

Floor Fixing H74 round steel table base,  
 Ø 80mm round steel column with cross.  
 Base per tavolo H74 rotonda in metallo  
 per fissaggio a terra, colonna rotonda in  
 metallo Ø 80mm, crociera.

Top max dimensions / Massima dimensione piano

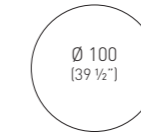

Available table tops / Piani tavolo disponibili

compactop  
 laminated  
 iron

Finishes for T1 bases / Finiture per basamenti serie T1

Polished Steel-Chromed Column / Acciaio Lucido-Colonna Cromata

●	H74	BAT1.S	0.07m <sup>3</sup> / 11kg / 1pcs
---	-----	--------	----------------------------------



# V1

H73 round chromed metal table base,  
 Ø 50mm chromed metal column with  
 cross.  
 Base per tavolo H73 rotonda in metallo  
 cromato, colonna in metallo cromato  
 Ø 50mm, crociera.

Top max dimensions / Massima dimensione piano

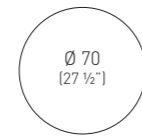

Available table tops / Piani tavolo disponibili

compactop  
 laminated  
 iron

Finishes for V1 bases / Finiture per basamenti serie V1

Polished Steel-Chromed Column / Acciaio Lucido-Colonna Cromata

●	H73	BV1C	0.1m <sup>3</sup> / 15.6kg / 2 pcs
---	-----	------	------------------------------------

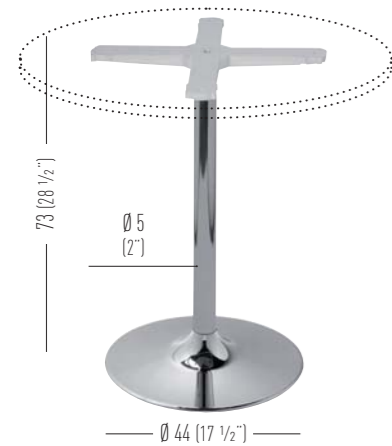



# Q1

H50-H74-H110 square steel table base,  
80x80mm steel column with cross.  
Base per tavolo quadrata in acciaio  
H50, H74 e H110, colonna in acciaio  
80x80mm, crociera.

Top max dimensions / Massima dimensione piano

Available table tops / Piani tavolo disponibili

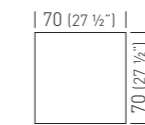

compactop  
laminated  
iron

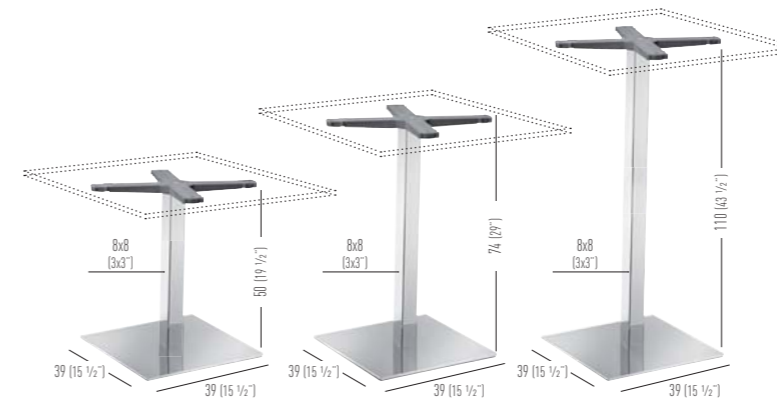

Finishes for Q bases / Finiture per basamenti serie Q

Polished Steel-Chromed Column / Acciaio Lucido-Colonna Cromata

	H50	BAQ1B.A		0.07m <sup>3</sup> / 17kg / 1pcs
	H74	BAQ1.A		0.07m <sup>3</sup> / 17kg / 1pcs
	H110	BAQ1A.A		0.09m <sup>3</sup> / 19kg / 1pcs

Satin Steel-Satin Column / Acciaio Satinato-Colonna Satinata

	H50	BAQ1B.S		0.07m <sup>3</sup> / 17kg / 1pcs
	H74	BAQ1.S		0.07m <sup>3</sup> / 17kg / 1pcs
	H110	BAQ1A.S		0.09m <sup>3</sup> / 19kg / 1pcs

White Painted / Verniciata Bianca

	H50	BAQ1B.00		0.07m <sup>3</sup> / 17kg / 1pcs
	H74	BAQ1.00		0.07m <sup>3</sup> / 17kg / 1pcs
	H110	BAQ1A.00		0.09m <sup>3</sup> / 19kg / 1pcs

Black Painted / Verniciata Nera

	H50	BAQ1B.10		0.07m <sup>3</sup> / 17kg / 1pcs
	H74	BAQ1.10		0.07m <sup>3</sup> / 17kg / 1pcs
	H110	BAQ1A.10		0.09m <sup>3</sup> / 19kg / 1pcs





## Q2

**H50-H74-H110 square steel table base, 80x80mm steel column with cross.**  
 Base per tavolo quadrata in acciaio H50, H74 e H110, colonna in acciaio 80x80mm, crociera.

Top max dimensions / Massima dimensione piano

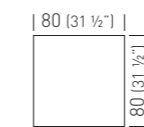

Available table tops / Piani tavolo disponibili

compactop  
laminated  
iron

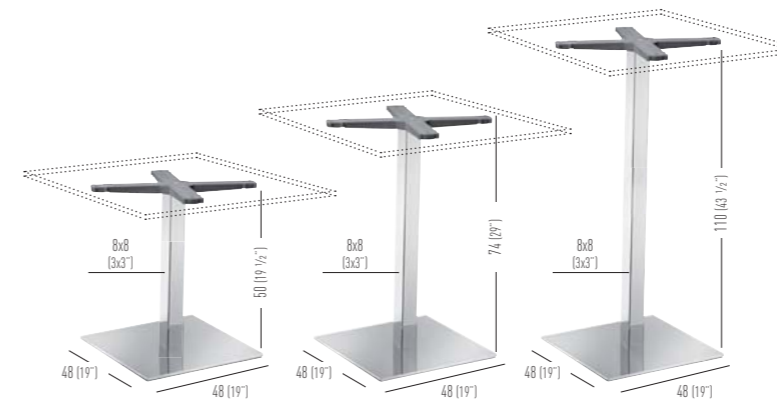

Finishes for Q bases / Finiture per basamenti serie Q

**Polished Steel-Chromed Column / Acciaio Lucido-Colonna Cromata**

●	H50	BAQ2B.A	0.07m <sup>3</sup> / 18kg / 1pcs
●	H74	BAQ2.A	0.07m <sup>3</sup> / 18kg / 1pcs
●	H110	BAQ2A.A	0.09m <sup>3</sup> / 20kg / 1pcs

**Satin Steel-Satin Column / Acciaio Satinato-Colonna Satinata**

●	H50	BAQ2B.S	0.07m <sup>3</sup> / 18kg / 1pcs
●	H74	BAQ2.S	0.07m <sup>3</sup> / 18kg / 1pcs
●	H110	BAQ2A.S	0.09m <sup>3</sup> / 20kg / 1pcs

**White Painted / Verniciata Bianca**

○	H50	BAQ2B.00	0.07m <sup>3</sup> / 18kg / 1pcs
○	H74	BAQ2.00	0.07m <sup>3</sup> / 18kg / 1pcs
○	H110	BAQ2A.00	0.09m <sup>3</sup> / 20kg / 1pcs

**Black Painted / Verniciata Nera**

●	H50	BAQ2B.10	0.07m <sup>3</sup> / 18kg / 1pcs
●	H74	BAQ2.10	0.07m <sup>3</sup> / 18kg / 1pcs
●	H110	BAQ2A.10	0.09m <sup>3</sup> / 20kg / 1pcs

## Q3

**H74-H110 square steel table base, 80x80mm steel column with cross.**  
 Base per tavolo quadrata in acciaio H74 e H110, colonna in acciaio 80x80mm, crociera.

Top max dimensions / Massima dimensione piano

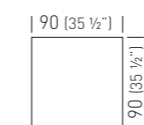

Available table tops / Piani tavolo disponibili

compactop  
laminated  
iron

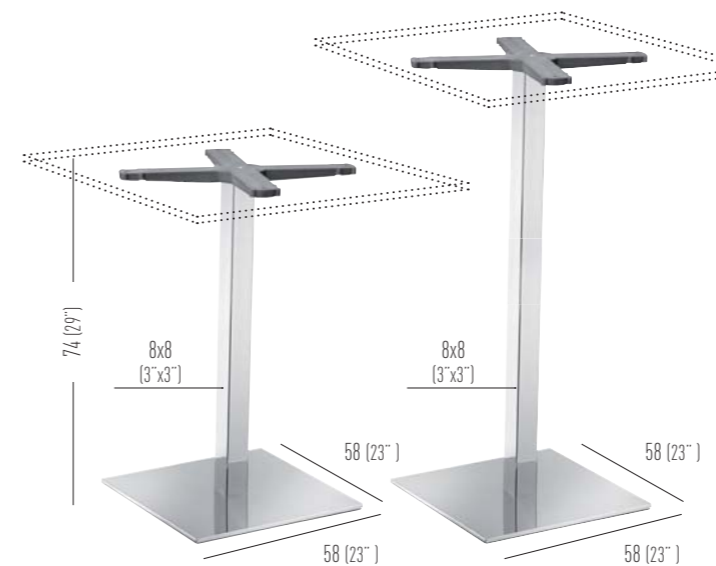

Finishes for Q bases / Finiture per basamenti serie Q

**Polished Steel-Chromed Column / Acciaio Lucido-Colonna Cromata**

●	H74	BAQ3.A	0.07m <sup>3</sup> / 23kg / 1pcs
●	H110	BAQ3A.A	0.09m <sup>3</sup> / 25kg / 1pcs

**Satin Steel-Satin Column / Acciaio Satinato-Colonna Satinata**

●	H74	BAQ3.S	0.07m <sup>3</sup> / 23kg / 1pcs
●	H110	BAQ3A.S	0.09m <sup>3</sup> / 25kg / 1pcs

**White Painted / Verniciata Bianca**

○	H74	BAQ3.00	0.07m <sup>3</sup> / 23kg / 1pcs
○	H110	BAQ3A.00	0.09m <sup>3</sup> / 25kg / 1pcs

**Black Painted / Verniciata Nera**

●	H74	BAQ3.10	0.07m <sup>3</sup> / 23kg / 1pcs
●	H110	BAQ3A.10	0.09m <sup>3</sup> / 25kg / 1pcs



## D2

H74-H110 double steel table base,  
80x80mm steel columns with cross.  
Base doppia per tavolo H74 e H110 in  
acciaio, colonne in acciaio 80x80mm,  
crociere.

Top max dimensions / Massima dimensione piano

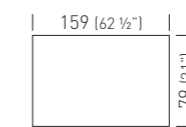

Available table tops / Piani tavolo disponibili

compactop  
laminated  
iron

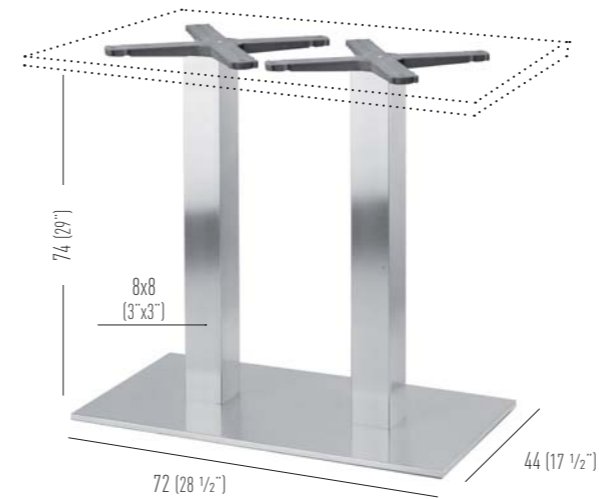

Finishes for D2 bases / Finiture per basamenti serie D2

Polished Steel-Chromed Column / Acciaio Lucido-Colonna Cromata



 H74 BAD2.A  0.22m<sup>3</sup> / 32kg / 1pcs

Satin Steel-Satin Column / Acciaio Satinato-Colonna Satinata

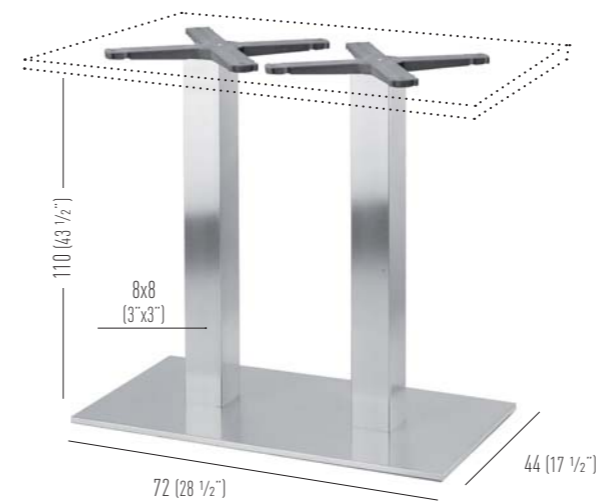

 H74 BAD2.S  0.22m<sup>3</sup> / 32kg / 1pcs



Polished Steel-Chromed Column / Acciaio Lucido-Colonna Cromata

 H110 BAD2.A.A  0.22m<sup>3</sup> / 35kg / 1pcs

Satin Steel-Satin Column / Acciaio Satinato-Colonna Satinata

 H110 BAD2.A.S  0.22m<sup>3</sup> / 35kg / 1pcs





# ALFIE

H72 4-Spur table base collection made of painted steel, Ø100mm metal painted column with cross. Adjustable feet. Collezione basamenti per tavoli, H72, quattro razze in acciaio verniciato, colonna in metallo verniciato Ø100mm con crociera. Piedini regolabili.



Available top sizes / Dimensioni piano disponibili

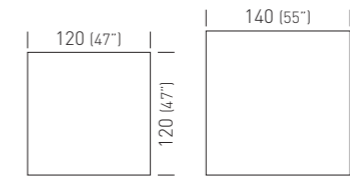

Available table tops / Piani tavolo disponibili  
laminated

Black Painted / Verniciata Nera



BALF.10

0.65m<sup>2</sup> / 15kg / 1pcs





# TATAMI

H74-H110 round steel table base,  
 Ø 80mm steel similar wood-effect column with cross.  
 Base per tavolo rotonda in acciaio H74 e H110,  
 colonna finto legno Ø 80mm, crociera.

Finishes for Tatami columns / Finiture per colonne serie Tatami



Top max dimensions / Massima dimensione piano

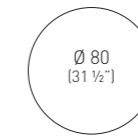

Available table tops / Piani tavolo disponibili

compactop  
 laminated  
 iron

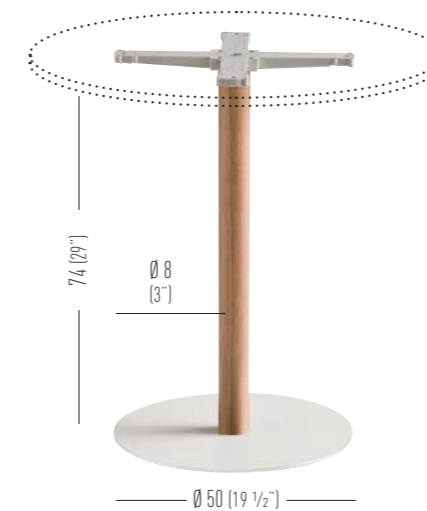

Finishes for TATAMI bases / Finiture per basamenti serie Tatami

Polished Steel / Acciaio Lucido



Satin Steel / Acciaio Satinato



White Painted / Verniciata Bianca



Black Painted / Verniciata Nera

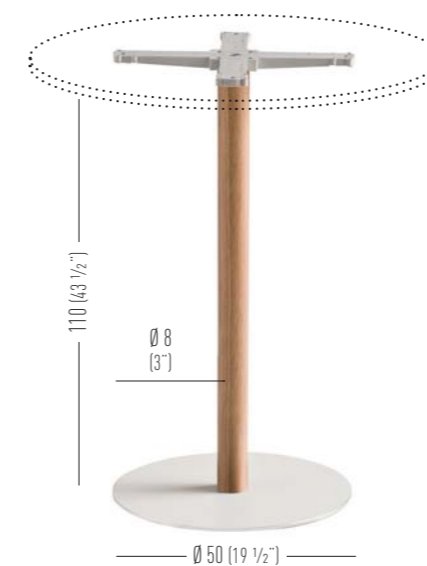

Finishes for TATAMI bases / Finiture per basamenti serie Tatami

Polished Steel / Acciaio Lucido



Satin Steel / Acciaio Satinato



White Painted / Verniciata Bianca



Black Painted / Verniciata Nera





OFFICE &  
WORKSPACES  
**Systems**



# Workstation 2027

Forsix Design

This office furniture collection is intended for modern workplaces. It is distinguished by simple and rational worktop lines as well as slender and resistant support frames with a trestle shape. The service cabinets are suspended, a feature designed for easy and modern cleaning. The desks can be equipped with high-performance sound-absorbing screens, to improve privacy and the general acoustics of the workplace. The assembly systems have been especially designed to be fast and safe.

Programma d'arredo destinato ad uffici moderni con piani di lavoro dalle linee semplici e razionali, strutture di sostegno con forma a cavalletto per essere snelle e resistenti. I mobili di servizio sono sospesi, caratteristica pensata per una semplice e moderna pulizia automatica. Le scrivanie possono essere dotate di schermi divisori per migliorare la privacy e l'acustica. I sistemi di assemblaggio sono veloci e sicuri.





### WORKSTATION 2027 DX VERSION 180



Workstation with 2027 structure, cabinet consisting of module with sliding doors and lock, 1 partition and 1 shelf per compartment, open module with 1 shelf. Straight desktop white colour, thickness 22mm.  
 Stazione di lavoro con struttura 2027, mobile composto da modulo con ante scorrevoli e serratura, 1 tramezza e 1 ripiano per vano, modulo a giorno con 1 ripiano. Piano scrivania di lavoro diritta di colore bianco, spessore 22mm.

Melamine Laquered Cabinets Colors  
 Colori Laccati Mobili Melaminico

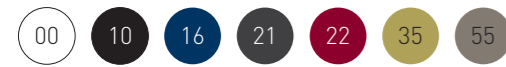

Frame colors  
 Colori struttura

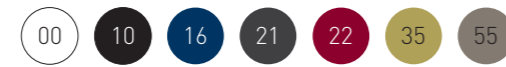

Melamine Cabinets Color  
 Colore Mobili Melaminico



Laminated top color  
 Colori piano laminato

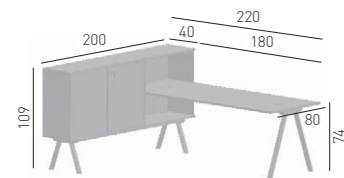

### WORKSTATION 2027 SX VERSION 180



Workstation with 2027 structure, cabinet consisting of module with sliding doors and lock, 1 partition and 1 shelf per compartment, open module with 1 shelf. Straight desktop white colour, thickness 22mm.  
 Stazione di lavoro con struttura 2027, mobile composto da modulo con ante scorrevoli e serratura, 1 tramezza e 1 ripiano per vano, modulo a giorno con 1 ripiano. Piano scrivania di lavoro diritta di colore bianco, spessore 22mm.

Melamine Laquered Cabinets Colors  
 Colori Laccati Mobili Melaminico



Frame colors  
 Colori struttura

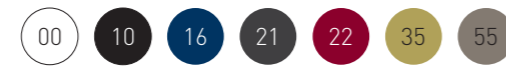

Melamine Cabinets Color  
 Colore Mobili Melaminico



Laminated top color  
 Colori piano laminato

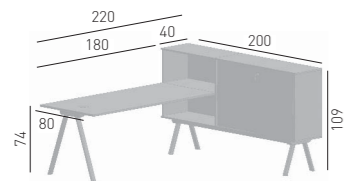

### WORKSTATION 2027 DX VERSION 240



Workstation with 2027 structure, cabinet consisting of module with sliding doors and lock, 1 partition and 1 shelf per compartment, open module with 1 shelf. Straight desktop white colour, thickness 22mm.  
 Stazione di lavoro con struttura 2027, mobile composto da modulo con ante scorrevoli e serratura, 1 tramezza e 1 ripiano per vano, modulo a giorno con 1 ripiano. Piano scrivania di lavoro diritta di colore bianco, spessore 22mm.

Melamine Laquered Cabinets Colors  
 Colori Laccati Mobili Melaminico



Frame colors  
 Colori struttura



Melamine Cabinets Color  
 Colore Mobili Melaminico



Laminated top color  
 Colori piano laminato

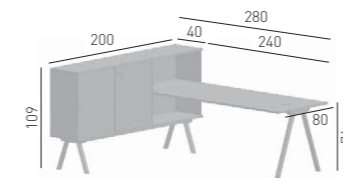

### WORKSTATION 2027 SX VERSION 240



Workstation with 2027 structure, cabinet consisting of module with sliding doors and lock, 1 partition and 1 shelf per compartment, open module with 1 shelf. Straight desktop white colour, thickness 22mm.  
 Stazione di lavoro con struttura 2027, mobile composto da modulo con ante scorrevoli e serratura, 1 tramezza e 1 ripiano per vano, modulo a giorno con 1 ripiano. Piano scrivania di lavoro diritta di colore bianco, spessore 22mm.

Melamine Laquered Cabinets Colors  
 Colori Laccati Mobili Melaminico



Frame colors  
 Colori struttura



Melamine Cabinets Color  
 Colore Mobili Melaminico



Laminated top color  
 Colori piano laminato

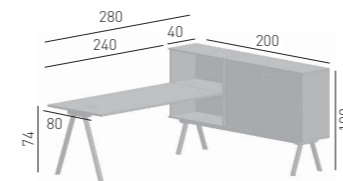

### WORKSTATION 2027 DX L-VERSION 180



Workstation with 2027 structure, cabinet consisting of module with sliding doors and lock, 1 partition and 1 shelf per compartment, open module with 1 shelf. Wraparound work desktop white colour, thickness 22mm.  
 Stazione di lavoro con struttura 2027, mobile composto da modulo con ante scorrevoli e serratura, 1 tramezza e 1 ripiano per vano, modulo a giorno con 1 ripiano. Piano scrivania di lavoro avvolgente di colore bianco, spessore 22mm.

Melamine Laquered Cabinets Colors  
 Colori Laccati Mobili Melaminico



Frame colors  
 Colori struttura



Melamine Cabinets Color  
 Colore Mobili Melaminico



Laminated top color  
 Colori piano laminato

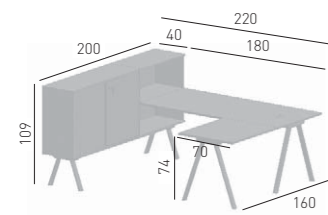

### WORKSTATION 2027 SX L-VERSION 180



Workstation with 2027 structure, cabinet consisting of module with sliding doors and lock, 1 partition and 1 shelf per compartment, open module with 1 shelf. Wraparound work desktop white colour, thickness 22mm.  
 Stazione di lavoro con struttura 2027, mobile composto da modulo con ante scorrevoli e serratura, 1 tramezza e 1 ripiano per vano, modulo a giorno con 1 ripiano. Piano scrivania di lavoro avvolgente di colore bianco, spessore 22mm.

Melamine Laquered Cabinets Colors  
 Colori Laccati Mobili Melaminico



Frame colors  
 Colori struttura



Melamine Cabinets Color  
 Colore Mobili Melaminico



Laminated top color  
 Colori piano laminato

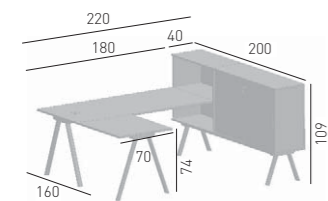

### WORKSTATION 2027 DX L-VERSION 240



Workstation with 2027 structure, cabinet consisting of module with sliding doors and lock, 1 partition and 1 shelf per compartment, open module with 1 shelf. Wraparound work desktop white colour, thickness 22mm.  
 Stazione di lavoro con struttura 2027, mobile composto da modulo con ante scorrevoli e serratura, 1 tramezza e 1 ripiano per vano, modulo a giorno con 1 ripiano. Piano scrivania di lavoro avvolgente di colore bianco, spessore 22mm.

Melamine Laquered Cabinets Colors  
 Colori Laccati Mobili Melaminico



Frame colors  
 Colori struttura



Melamine Cabinets Color  
 Colore Mobili Melaminico



Laminated top color  
 Colori piano laminato

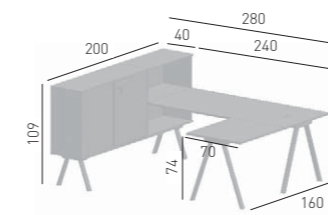

### WORKSTATION 2027 SX L-VERSION 240



Workstation with 2027 structure, cabinet consisting of module with sliding doors and lock, 1 partition and 1 shelf per compartment, open module with 1 shelf. Wraparound work desktop white colour, thickness 22mm.  
 Stazione di lavoro con struttura 2027, mobile composto da modulo con ante scorrevoli e serratura, 1 tramezza e 1 ripiano per vano, modulo a giorno con 1 ripiano. Piano scrivania di lavoro avvolgente di colore bianco, spessore 22mm.

Melamine Laquered Cabinets Colors  
 Colori Laccati Mobili Melaminico



Frame colors  
 Colori struttura



Melamine Cabinets Color  
 Colore Mobili Melaminico



Laminated top color  
 Colori piano laminato

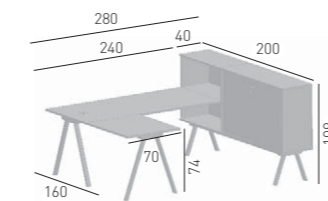



## WORKSTATION 2027 DX VERSION 180 WITH BENCH



Workstation with 2027 structure, cabinet consisting of module with sliding doors and lock, 1 partition and 1 shelf per compartment, open module with 1 shelf. Straight desktop white colour, thickness 22mm. Bench module with padded and upholstered seats.  
Stazione di lavoro con struttura 2027, mobile composto da modulo con ante scorrevoli e serratura, 1 tramezza e 1 ripiano per vano, modulo a giorno con 1 ripiano. Piano scrivania di lavoro diritta di colore bianco, spessore 22mm. Modulo panca con sedute imbottite e tappezzate.

**BENCH module available coverings / Finiture disponibili modulo panca**  
King fabric / Tessuto King **K**  
Aurea eco-leather / Ecopelle Aurea **E**  
Blazer fabric / Tessuto Blazer **B**  
Leather / Pelle **P**  
Kvadrat fabrics / Tessuti Kvadrat **DK**

Melamine Laquered Cabinets Colors  
Colori Laccati Mobili Melaminico

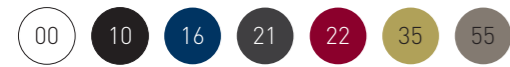

Frame colors  
Colori struttura

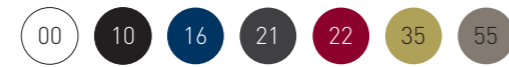

Melamine Cabinets Color  
Colore Mobili Melaminico



Laminated top color  
Colori piano laminato

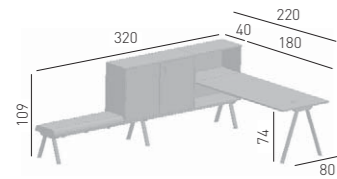

## WORKSTATION 2027 DX VERSION 240 WITH BENCH



Workstation with 2027 structure, cabinet consisting of module with sliding doors and lock, 1 partition and 1 shelf per compartment, open module with 1 shelf. Straight desktop white colour, thickness 22mm. Bench module with padded and upholstered seats.  
Stazione di lavoro con struttura 2027, mobile composto da modulo con ante scorrevoli e serratura, 1 tramezza e 1 ripiano per vano, modulo a giorno con 1 ripiano. Piano scrivania di lavoro diritta di colore bianco, spessore 22mm. Modulo panca con sedute imbottite e tappezzate.

**BENCH module available coverings / Finiture disponibili modulo panca**  
King fabric / Tessuto King **K**  
Aurea eco-leather / Ecopelle Aurea **E**  
Blazer fabric / Tessuto Blazer **B**  
Leather / Pelle **P**  
Kvadrat fabrics / Tessuti Kvadrat **DK**

Melamine Laquered Cabinets Colors  
Colori Laccati Mobili Melaminico

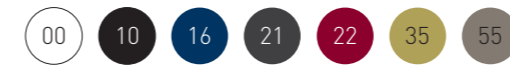

Frame colors  
Colori struttura



Melamine Cabinets Color  
Colore Mobili Melaminico



Laminated top color  
Colori piano laminato

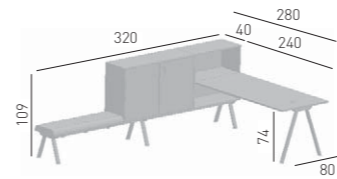

## WORKSTATION 2027 SX VERSION 180 WITH BENCH



Workstation with 2027 structure, cabinet consisting of module with sliding doors and lock, 1 partition and 1 shelf per compartment, open module with 1 shelf. Straight desktop white colour, thickness 22mm. Bench module with padded and upholstered seats.  
Stazione di lavoro con struttura 2027, mobile composto da modulo con ante scorrevoli e serratura, 1 tramezza e 1 ripiano per vano, modulo a giorno con 1 ripiano. Piano scrivania di lavoro diritta di colore bianco, spessore 22mm. Modulo panca con sedute imbottite e tappezzate.

**BENCH module available coverings / Finiture disponibili modulo panca**  
King fabric / Tessuto King **K**  
Aurea eco-leather / Ecopelle Aurea **E**  
Blazer fabric / Tessuto Blazer **B**  
Leather / Pelle **P**  
Kvadrat fabrics / Tessuti Kvadrat **DK**

Melamine Laquered Cabinets Colors  
Colori Laccati Mobili Melaminico



Frame colors  
Colori struttura

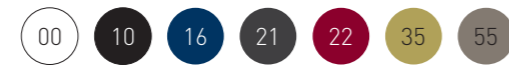

Melamine Cabinets Color  
Colore Mobili Melaminico



Laminated top color  
Colori piano laminato

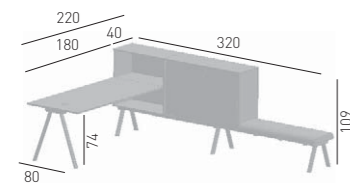

## WORKSTATION 2027 SX VERSION 240 WITH BENCH



Workstation with 2027 structure, cabinet consisting of module with sliding doors and lock, 1 partition and 1 shelf per compartment, open module with 1 shelf. Straight desktop white colour, thickness 22mm. Bench module with padded and upholstered seats.  
Stazione di lavoro con struttura 2027, mobile composto da modulo con ante scorrevoli e serratura, 1 tramezza e 1 ripiano per vano, modulo a giorno con 1 ripiano. Piano scrivania di lavoro diritta di colore bianco, spessore 22mm. Modulo panca con sedute imbottite e tappezzate.

**BENCH module available coverings / Finiture disponibili modulo panca**  
King fabric / Tessuto King **K**  
Aurea eco-leather / Ecopelle Aurea **E**  
Blazer fabric / Tessuto Blazer **B**  
Leather / Pelle **P**  
Kvadrat fabrics / Tessuti Kvadrat **DK**

Melamine Laquered Cabinets Colors  
Colori Laccati Mobili Melaminico



Frame colors  
Colori struttura



Melamine Cabinets Color  
Colore Mobili Melaminico



Laminated top color  
Colori piano laminato

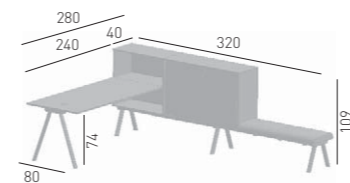

## WORKSTATION 2027 X VERSION 180



Double workstation with 2027 structure, 2 cabinets consisting of modules with sliding doors and lock, 1 partition and 1 shelf per compartment, 1 open module with 1 shelf.  
Straight desktop white colour, thickness 22mm.  
Stazione di lavoro doppia con struttura 2027, 2 mobili composto da moduli con ante scorrevoli e serratura, 1 tramezza e 1 ripiano per vano, 1 modulo a giorno con 1 ripiano. Piani scrivania di lavoro dritti di colore bianco, spessore 22mm.

Melamine Laquered Cabinets Colors  
Colori Laccati Mobili Melaminico



Frame colors  
Colori struttura



Melamine Cabinets Color  
Colore Mobili Melaminico



Laminated top color  
Colori piano laminato

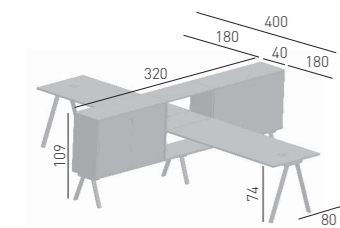

## WORKSTATION 2027 X VERSION 240



Double workstation with 2027 structure, 2 cabinets consisting of modules with sliding doors and lock, 1 partition and 1 shelf per compartment, 1 open module with 1 shelf.  
Straight desktop white colour, thickness 22mm.  
Stazione di lavoro doppia con struttura 2027, 2 mobili composto da moduli con ante scorrevoli e serratura, 1 tramezza e 1 ripiano per vano, 1 modulo a giorno con 1 ripiano. Piani scrivania di lavoro dritti di colore bianco, spessore 22mm.

Melamine Laquered Cabinets Colors  
Colori Laccati Mobili Melaminico



Frame colors  
Colori struttura



Melamine Cabinets Color  
Colore Mobili Melaminico



Laminated top color  
Colori piano laminato

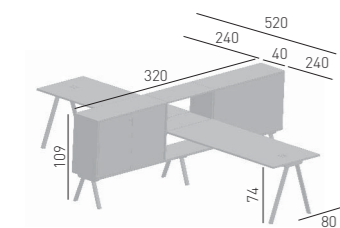



# Cabinets

Forsix Design



To store files and folders in a world of colours. These filing cabinets are suspended, on frames, for easy obstruction-free cleaning. The cabinets themselves, tough and resistant, come with quick and effective assembly fixings. Drawers: On castors and fitted, these simple pieces help keep workspaces tidy and stationary in place.

Per contenere, archiviare e classificare, in un mondo a colori. I mobili contenitori sono sospesi, su strutture a cavalletto, per una semplice pulizia anche automatica. Le strutture, solide e resistenti, sono provviste di sistemi di assemblaggio veloci e sicuri.

Cassettiere: Su ruote e attrezzate, questi semplici complementi aiutano a contenere e ordinare le piccole necessità dell'ufficio.





## LOW CABINET 2027



Cabinet consisting of 2027 structure, 1 module with sliding doors and lock, 1 partition and 1 shelf per compartment, module with 2 filing cabinets. On request it is possible to replace the module with two filing cabinets with two drawers module. Maximum load on each sliding filing cabinet Kg. 20.

Mobile composto da struttura 2027, modulo con ante scorrevoli e serratura, 1 tramezza e 1 ripiano per vano, modulo con 2 classificatori. Su richiesta, è possibile sostituire il modulo a due classificatori con il modulo a due cassetti estraibili. Carico massimo su ogni classificatore estraibile Kg.20.

Melamine Laquered Cabinets Colors  
Colori Laccati Mobili Melaminico



Frame colors  
Colori struttura



Melamine Cabinets Color  
Colore Mobili Melaminico

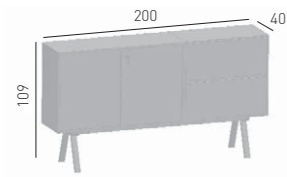

## CABINET 2027



Cabinet consisting of 2027 structure and module with sliding doors and lock, 1 Partition and 2 shelves per compartment.

Mobile composto da struttura 2027 e modulo con ante scorrevoli e serratura, 1 tramezza e 2 ripiani per vano.

Melamine Laquered Cabinets Colors  
Colori Laccati Mobili Melaminico



Frame colors  
Colori struttura



Melamine Cabinets Color  
Colore Mobili Melaminico

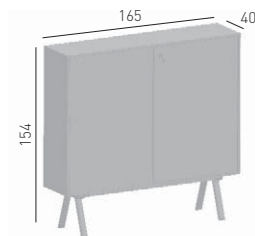

## MULTIPLE CABINET 2027



Cabinet consisting of 2027 structure and two modules with sliding doors and lock, 1 Partition and 2 shelves per compartment.

Mobile composto da struttura 2027 e 2 moduli con ante scorrevoli e serratura, 1 tramezza e 2 ripiani per vano.

Melamine Laquered Cabinets Colors  
Colori Laccati Mobili Melaminico



Frame colors  
Colori struttura



Melamine Cabinets Color  
Colore Mobili Melaminico

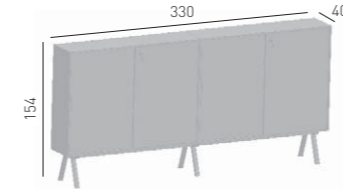

## HIGH CABINET 2027



Cabinet consisting of 2027 structure, two modules with sliding doors and locks, 1 partition and 1 shelf per compartment, module with 2 filing cabinets, open module with 1 shelf. On request it is possible to replace the module with two filing cabinets with two drawers module. Maximum load on each sliding filing cabinet Kg. 20.

Mobile composto da struttura 2027, due moduli con ante scorrevoli e serrature, 1 tramezza e 1 ripiano per vano, modulo con 2 classificatori, modulo a giorno con 1 ripiano. Su richiesta, è possibile sostituire il modulo a due classificatori con il modulo a due cassetti estraibili. Carico massimo su ogni classificatore estraibile Kg.20.

Melamine Laquered Cabinets Colors  
Colori Laccati Mobili Melaminico



Frame colors  
Colori struttura



Melamine Cabinets Color  
Colore Mobili Melaminico

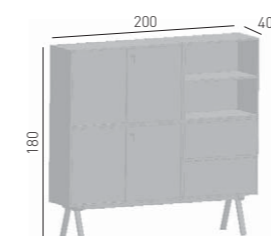



## LOW CABINET 2027 + SEATER



Cabinet consisting of 2027 structure, 1 module with sliding doors and lock, 1 partition and 1 shelf per compartment, upholstered service seats.  
 Mobile composto da struttura 2027, modulo con ante scorrevoli e serratura, 1 tramezza e 1 ripiano per vano, sedute imbottite di servizio.

BENCH module available coverings / Finiture disponibili modulo panca  
 King fabric / Tessuto King **K**  
 Aurea eco-leather / Ecopelle Aurea **E**  
 Blazer fabric / Tessuto Blazer **B**  
 Leather / Pelle **P**  
 Kvadrat fabrics / Tessuti Kvadrat **DK**

Melamine Laquered Cabinets Colors  
 Colori Laccati Mobili Melaminico



Frame colors  
 Colori struttura



Melamine Cabinets Color  
 Colore Mobili Melaminico

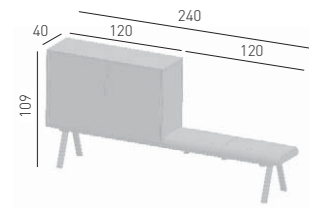

## DRAWER



Drawer on rubber wheels with lock. 3 drawers plus office product bin.  
 Cassettiera su ruote gommate con serratura. 3 cassetti più portacancelleria.

Melamine Laquered Drawer Colors  
 Colori Laccati Cassettiera Melaminico



Melamine Drawer Color  
 Colore Cassettiera Melaminico

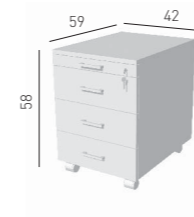

# Display

Kristine Flensted Nielsen Design



Frame colors / Colori struttura

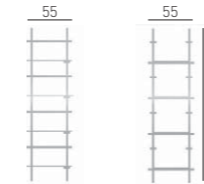

Single metal frame "Display", matt painted.  
Struttura singola in metallo verniciato opaco "Display"

Fenix laminated top color / Colori piano laminato Fenix



Laminated shelve "Display".  
Mensola in laminato "Display"

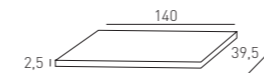

Display example of use



Display wall or floor fixed storage shelving can enhance your most ambitious projects. Available with a black, gold or white matt painted steel frame, without any visible welds, Display is set off with solid Fenix laminate shelves. Display is a modular piece, which can support up to 4 shelves and lends itself to completing and finely decorating walls and corners of your commercial spaces. For correct use, the structure must be fixed to the wall or floor.

Semplice ed elegante, Display decorerà con discrezione i vostri progetti più ambiziosi. Disponibile con struttura in acciaio verniciato nero, oro o bianco opaco, senza nessuna saldatura a vista, è impreziosito da solidi ripiani in laminato Fenix. Display è un elemento modulare, che può sostenere sino a 4 mensole e si presta a completare e decorare con raffinatezza pareti ed angoli dei vostri spazi commerciali. Per un corretto utilizzo, questo mobile deve essere fissato alla parete o pavimento.



# Culture

Malene Flensted Urup Design



Frame Color / Colore Struttura

10



The Culture hanging planters, designed by Malene Flensted Urup, are an interesting system to bring what normally attracts the outdoors in, into workplace and hospitality settings. The Culture system easily creates oases of calm with a minimalist look: practical and good looking, simplifying the cleanliness and order of the most contemporary environments.

Available in two sizes, these planters have been created to be fixed to the ceiling, thus creating vertical gardens even in limited spaces areas.

Le fioriere pensili Culture, disegnate da Malene Flensted Urup, sono un'interessante sistema per portare ciò che normalmente richiama l'outdoor all'interno, in stanze dedicate all'ambiente di lavoro e all'ospitalità.

Il sistema Culture crea facilmente delle oasi di calma dal look minimalista: pratiche e piacevoli alla vista, semplificano la pulizia e l'ordine degli ambienti più contemporanei.

Disponibili in due dimensioni, le fioriere sono state create per essere fissate al soffitto e creare quindi giardini verticali anche in aree dove lo spazio è limitato.



# Flaire

Studio Eurolinea Design

Techno-polymer Lamp collection with diffused shine effect.  
Collezione di lampade in materiale plastico con effetto a bagliore diffuso.



Colors / Colori

00

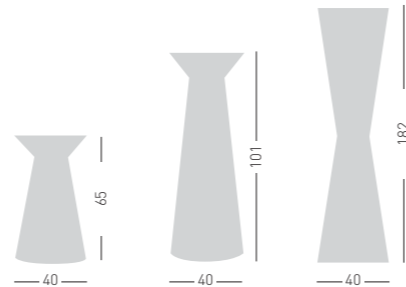

# Lux

Studio Eurolinea Design



Anodized aluminum  
and techno-polymer coat-hanger.

Appendiabiti in alluminio  
anodizzato e tecnopolimero

Colors / Colori





# COLOURS AND COVERINGS

## COLORI E RIVESTIMENTI

Techno-polymer / Tecnopolimero

 05 Light blue / Azzurro	 99 Lavender / Lavanda	 98 Pale blue / Avio	 34 Light blue / Azzurro	 08 Blue / Blu	 09 Dark Blue / Blu scuro	 16 Indigo / Indaco	 11 Night Blue / Blu notte
 03 Light green / Verdino	 42 Green / Verde	 51 Sage green / Salvia	 35 Lime / Lime	 41 Green / Verde	 25 Olive Green / Verde Oliva	 23 Military green / Verde militare	 24 Forest green / Verde foresta
 36 Mustard / Senape	 02 Yellow / Giallo	 38 Saffron / Zafferano	 07 Apricot / Albicocca	 33 Orange / Arancione	 20 Lobster / Aragosta	 06 Red / Rosso	 12 Brick / Mattone
 26 Marsala / Marsala	 22 Bordeaux / Bordeaux	 01 Beige / Beige	 54 Sand / Sabbia	 18 Dusty Rose / Polvere Rosa	 13 Brown / Marrone	 52 Turtledove / Tortora	 55 Mineral Grey / Grigio Minerale
 39 Brown / Marrone	 00 White / Bianco	 14 Pearl grey / Grigio perla	 04 Grey / Grigio	 21 Grey / Grigio	 10 Black / Nero		
 46 Transp. green / Verde trasp.	 45 Transp. red / Rosso trasp.	 47 Transp. Amber / Ambra trasp.	 44 Transparent / Trasparente				

Metal finishes / Finiture metalli

 C Chromed / Cromato	 S Satin / Satinato	 B White / Bianco	 N Black / Nero	 D Gold / Oro
 98 Pale blue / Avio	 16 Indigo / Indaco	 35 Lime / Lime	 02 Yellow / Giallo	 06 Red / Rosso
 12 Brick / Mattone	 22 Bordeaux / Bordeaux	 54 Sand / Sabbia	 18 Dusty Rose / Polvere Rosa	 55 Mineral Gray / Grigio Minerale
 14 Pearl Grey / Grigio Perla	 21 Grey / Grigio Antracite			

Bases and frames wooden finishes / Finiture legno basi e telai



00 White stained / Bianco



F Natural Beech / Faggio naturale



RN Natural Oak / Rovere Naturale



10 Black stained / Nero

F-00-10 finishes arise from Beech Essence. RN finish come from Oak Essence  
 Le finiture F-00-10 derivano da essenza di Faggio. La finitura RN deriva da essenza di Rovere.

Standard Compactop Surface

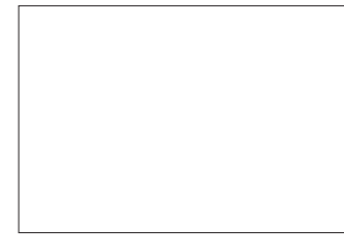

00



10



14

Special Compactop Surface Fenix - [www.fenixforinteriors.com](http://www.fenixforinteriors.com)



0029



0720

Special Compactop Surface - Solid - [www.arpaindustriale.com](http://www.arpaindustriale.com)



244



527

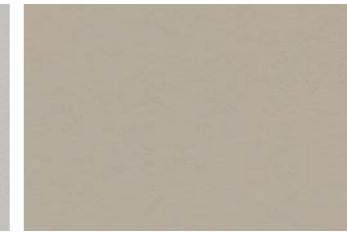

247



526

Special Compactop Surface - Wood Effect - [www.arpaindustriale.com](http://www.arpaindustriale.com)



4529



4543



4587



4511



Special Compactop Surface - Stone, Concrete and Marble Effect - [www.arpaindustriale.com](http://www.arpaindustriale.com)



3192

3349

3276

3329



5547

Special Compactop Surface - Marble Effect - [www.lamicolor.it](http://www.lamicolor.it)



6075

6076

6089

Standard Laminated Surface



F

RN

W

00



10

Special Laminated Surface - Wood Effect

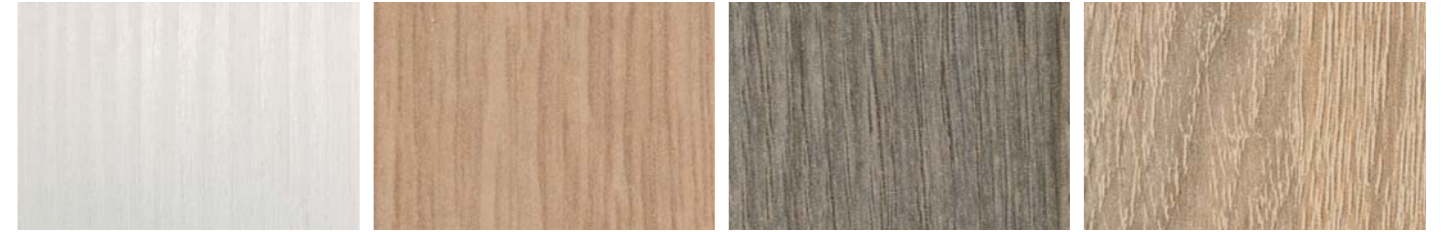

B01

X41

61M

V32



WGB



WG9

Special Laminated Surface - Fenix - [www.fenixforinteriors.com](http://www.fenixforinteriors.com)

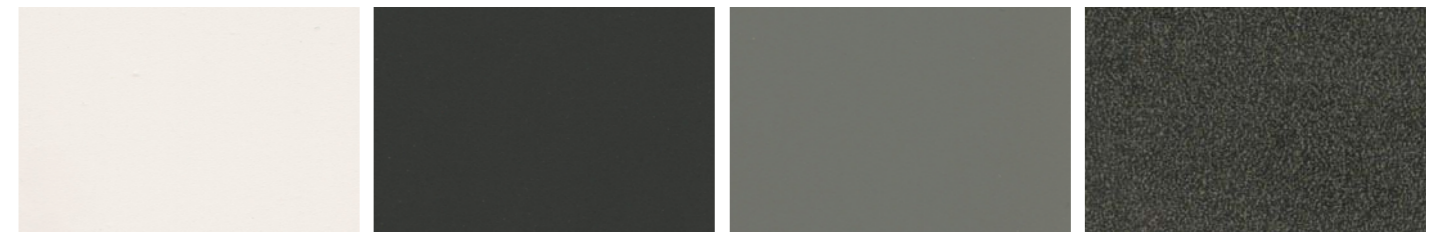

0029

720

718

2630



2629



2628



## Marble Surface



MBC - BIANCO CARRARA



MNM - NERO MARQUINA

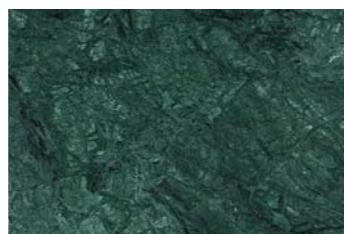

MVG - VERDE GUATEMALA

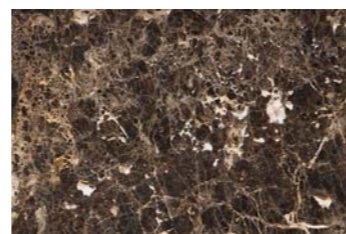

MED - EMPERADOR DARK

## Porcelain Surface



PCO - CALACATTA ORO

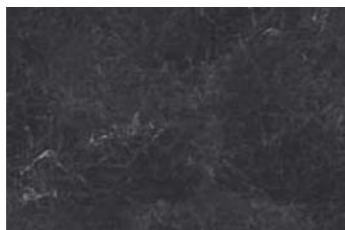

PNG - NERO GRECO

### GABER® LITERATURE

All Gaber® literature contains technical information and use-suggestions for those who intend to purchase or already have bought items from the Gaber® range. For Customers' interest, the Company may modify its products without any prior notice. Drawings, quoted materials and catalogue colors and price-lists are shown as a guide only and subject to tolerances. Dimensions are provided also in inches (") has a guide only. The colors displayed in Gaber® literature, related to technopolymer finishing and coverings, fabrics, leather, lacquered or painted materials, wooden items, may change from time to time. Gaber® reserves the right to suspend the production of any of its products without any notice or reason. All rights of reproduction in whole or in part of Gaber® literature, related to text, images or illustration, or transmitted by any means, electronic or mechanical, including photocopying, recording or any information storage without written permission from Gaber®, are reserved worldwide

### MATERIALS, USE AND MAINTENANCE

#### Plastic Materials

The Techno Polymer Compounds Gaber® uses on its products are characterized by high structural resistance, heat and abrasion resistance. Gaber® technopolymers are non-toxic, stain resistant, antistatic and UV-resistant: thanks to all these features these materials have excellent resistance to atmospheric agents. All these materials are recyclable in the full respect of our Natural Environment. Gaber produces plastic injected materials without added chemicals and, as far as possible, recycled technopolymers are sourced as a base raw material, recovered post-consumption.

Guidelines for correct usage: To maintain the Gaber's techno-polymer products in perfect conditions trough time and guarantee a long lasting quality of the raw materials we hereby recommend very basic care instructions to be followed. Cleaning advices: Techno-polymer surfaces usually needs to be cleaned with a normal cloth and warm water; for the most persistent stains a small amount of liquid soap diluted in water may be used. We recommend to strictly avoid all types of abrasive substances, like for example powdered cleaning products, creams, score pads and rough sponges. Gaber's techno-polymer products can be sanitized using different substances, for more information check on the web "polypropylene chemicals resistance compatibility"; the use of these substances also depends on the temperature, pressure and concentration. It is always a good practice, after sanitizing the techno-polymer products with these substances, rinse immediately the products with water. Any liquid spilt on the product must be wiped up immediately. Even products made especially for outdoor purposes could be affected by atmospheric agents. Products may undergo exterior changes due to particular exposure to heat, humidity and salinity. Products may change color and shade if exposed to direct sunlight. An appropriate and frequent maintenance and cleaning of the products enhances its durability. Maintenance has to be carried out by experienced staff.

Gaber® glides and floorpads are made of blended rubber for heavy-duty use and are designed to minimise noise. Certain Gaber® items come ready-fitted with felt floorpads, specifically for hard or especially delicate floors.

Gaber® manufactures some bespoke products of its collection with fire retardant techno polymer: the additives that make the fireproof plastic can substantially change the aesthetics and durability of the product.

#### Steel

High-resistance steel is used to produce frames for chairs, stools and tables by using square or round tubes as well as solid rod. Products are available in chrome or painted finishes. Special epoxy powder coating used on many Gaber® structures achieves excellent resistance to atmospheric agents.

#### Aluminum

Gaber® use aluminum to produce frames for chairs, stools and tables. Aluminum surfaces can be anodized, and Gaber® use this special treatment in order to increase resistance to corrosion.

Guidelines for correct usage: both steel and aluminum surfaces usually need to be cleaned with a normal cloth and warm water. For the most persistent stains, a small amount of mild liquid soap diluted in water may be used. Any liquid spilt on the product must be wiped up immediately. We recommend avoiding all types of abrasive creams or pastes, abrasive sponges, chlorine, bleach or strong detergents.

#### Wood

Our wooden products are produced in accordance with the European Regulations in force regarding formaldehyde emissions from wood-based products.

Guidelines for correct usage: Wooden products, being natural materials, can be damaged easily. Small impurities or imperfections are within quality standard range. Plywood surfaces need to be cleaned with a cloth and water. We recommend drying immediately after the cleaning process.

#### Flexible polyurethane padding

The flexible polyurethane cold-pressed paddings Gaber® uses on some of its upholstered products do not contain CFC/HCFC (ODP=0: do not contribute the reduction of the atmospheric ozone layer), they are fire-retardant class 1-IM UNI 9175 / CMHR following European Standards.

#### Coverings: Fabrics and Leathers

Gaber® uses fabrics and leathers that belong to a wide range of colors and patterns, which are all tested in order to achieve the best performance, among which resistance to abrasion and artificial light. Fire-retardant fabrics and eco-leather upholstery are also available.

Guidelines for correct usage: Clean leathers with a soft cloth with water. Refer to technical specifications for fabric cleaning.

#### PACKAGING AND RECYCLING

Our packages are designed to optimize storage and transport requirements, they are made of 90% recycled raw material and are completely recyclable in themselves. The optimization of packaging in terms of volume and weight delivers a lower consumption of energy in many forms, helping the environment and a consequent saving on transport costs. In order to avoid the loss of components, packaging must be disposed only after completing the assembly of the products. Once the product has been dismantled, the product itself or its components must be given to public garbage system, according to local rules.

#### INNAPROPRIATE USES OF THE PRODUCT

Avoid any improper use of the product; do not step on the product, do not stand on footrest or on armrests, do not seat on the back or on armrest, do not use the chair as a ladder. The product should not be subjected to swinging back and forwards that may damage the furniture or result in injury to the user. When lifting or moving the product, hold it by the main structure and not just under the seat. Gaber® will accept no liability for any damages caused to property or persons subsequent to incorrect or improper handling of the product. Gaber® also declines any responsibility in cases of damage caused to fragile floors.





#### DOCUMENTAZIONE GABER®

La documentazione Gaber® contiene informazioni tecniche e consigli d’uso per chi vuole acquistare o possiede articoli facenti parte della gamma prodotti Gaber®. Nell’interesse della clientela, Gaber® si riserva il diritto di modificare i propri modelli in ogni momento, senza obbligo di preavviso. I disegni, le quote, i materiali ed i colori dei cataloghi e del listino Gaber® si intendono a titolo puramente indicativo, e soggetti a tolleranze. Le dimensioni in pollici (”) sono da considerarsi indicative. I toni di colore rappresentati o presenti nelle palette colori e rivestimenti, relativi ai tessuti, alla pelle, alle laccature, ai vetri, e alle essenze legno, sono indicativi, in quanto passibili di variazioni da partita a partita. Gaber® declina ogni responsabilità in relazione a leggere differenze di tonalità. Gaber® si riserva inoltre il diritto di ritirare, sospendere o cessare la produzione di ogni singolo suo prodotto in qualsiasi momento e a sua discrezione senza darne preventivo avviso. Tutti i diritti di riproduzione, anche parziale, di cataloghi e listini Gaber® relativi a testi, immagini, illustrazioni, disegni, sia con mezzi meccanici che elettronici, incluso fotocopie o la formazione di sorgenti di informazione, senza il preventivo permesso scritto di Gaber®, sono globalmente riservati.

#### MATERIALI UTILIZZATI E MANUTENZIONE

##### Le Materie Plastiche

I compound di tecnopolimeri utilizzati da Gaber® nella realizzazione dei propri prodotti sono caratterizzati da un’elevata resistenza strutturale, termica e all’abrasione. Il tecnopolimero componente dei prodotti Gaber® è atossico, antimacchia, antistatico e anti-uv: qualità che lo rendono ottimamente resistente agli agenti atmosferici. I tecnopolimeri utilizzati da Gaber® sono integralmente riciclabili, nel pieno rispetto del nostro Ambiente Naturale. Gaber produce articoli termoplastici senza additivi chimici e, ove possibile, vengono utilizzati tecnopolimeri riciclati derivanti da post-consumo.

Piccole Accortezze: Per mantenere i prodotti Gaber in tecnopolimero in perfette condizioni nel tempo e garantire una qualità duratura delle materie prime, raccomandiamo di seguire le seguenti semplici istruzioni di utilizzo e manutenzione. Consigli per la pulizia: normalmente le superfici in tecnopolimero devono essere pulite con un normale panno e acqua calda; per le macchie più persistenti si può utilizzare una piccola quantità di sapone liquido diluito in acqua. Si consiglia di evitare rigorosamente tutti i tipi di sostanze abrasive, come ad esempio prodotti per la pulizia in polvere, creme, tamponi e spugne ruvide. I prodotti in tecnopolimero Gaber possono essere sanificati utilizzando diverse sostanze, per maggiori informazioni verificare sul web “compatibilità resistenza chimica polipropilene”; l’uso di queste sostanze dipende anche dalla temperatura, pressione e concentrazione. È sempre buona norma, dopo aver igienizzato i prodotti in tecnopolimero con queste sostanze, sciacquare immediatamente i prodotti con acqua. I liquidi versati sul prodotto devono essere asciugati subito. I prodotti destinati all’uso esterno subiscono comunque nel tempo l’azione degli agenti atmosferici. Eventuali alterazioni superficiali possono verificarsi a specifiche condizioni di temperatura, umidità e salinità. Il prodotto se esposto alla luce diretta del sole può essere soggetto a variazioni di colore. Una corretta e frequente manutenzione e pulizia aumentano la durabilità del prodotto. Interventi di manutenzione devono essere eseguiti da personale esperto.

I tappi e le protezioni dei prodotti Gaber® sono realizzati in una miscola di gomma ad alta resistenza all’ usura, atta a diminuire il rumore da trascinamento. Alcuni prodotti Gaber® sono dotati di tappi con feltri, adatti a pavimenti rigidi e più delicati.

Gaber® realizza su commessa alcuni prodotti della propria collezione con tecnopolimeri ignifughi: gli additivi che rendono il manufatto plastico ignifugo possono variare sostanzialmente l’estetica e la resistenza del prodotto.

##### L’ Acciaio

L’acciaio ad alta resistenza è utilizzato nelle strutture di tavoli, sedie e sgabelli, realizzati da Gaber® per mezzo di tubolari a sezione quadrata e rotonda, o con rondino. I prodotti sono disponibili con finitura cromata o verniciata. La speciale verniciatura a polveri epossidiche utilizzata da Gaber® per alcune strutture dei propri prodotti raggiunge una resistenza ottimale agli agenti atmosferici.

##### L’ Alluminio

Gaber® utilizza l’alluminio per realizzare le strutture di tavoli, sedie e sgabelli. La finitura per mezzo del trattamento superficiale di anodizzazione, utilizzata in alcuni prodotti, ha lo scopo di aumentarne la resistenza alla corrosione.

Piccole Accortezze: sia le superfici metalliche in acciaio che in alluminio devono essere pulite con un panno umido e soffice imbevuto in acqua calda. Per le macchie più ostinate è possibile diluire in acqua del sapone neutro liquido con moderazione. Asciugare sempre dopo la pulizia con un panno morbido. Non usare creme o paste per pulire i metalli, non usare cloro, candeggina o detersanti aggressivi. Non usare paste o spugne abrasive che possano graffiare le superfici metalliche.

##### Il legno

I prodotti Gaber® con elementi in legno sono prodotti di accordo con le vigenti normative Europee rispetto alle emissioni di formaldeide.

“Compound-wood” è il particolare materiale utilizzato da Gaber® per la realizzazione dei prodotti Alhambra-Eco ed Epica-Eco. Questo materiale utilizza fibre di legno derivanti dagli stessi processi di produzione con cui Gaber realizza elementi in materiale legnoso. Niente viene sprecaato.

Piccole Accortezze: Le superfici in legno, essendo un materiale naturale, potrebbero, nel tempo, subire alterazioni di colore con l’utilizzo e con l’esposizione alla luce. Inoltre, per loro natura, tali superfici sono facilmente danneggiabili, alcune piccole impurità e imperfezioni rientrano negli standard di qualità accettati. Le superfici in legno non possono sopportare fonti di calore dirette. Pulire le superfici in legno con un panno umido e soffice, imbevuto in acqua tiepida. Asciugare immediatamente dopo la pulizia.

##### Le imbottiture in poliuretano flessibile

Le imbottiture di alcuni prodotti Gaber® sono realizzate in poliuretano flessibile, stampato a freddo, privo di CFC/HCFC (ODP=0 : non contribuisce alla riduzione dello strato di ozono atmosferico), autoestinguente classe 1-IM Uni 9175 / CMHR, seguendo le normative Europee in materia.

##### I rivestimenti: tessuti e pelli

Tessuti e Pelli utilizzati da Gaber® appartengono ad un’ampia gamma di colori e trame, tutti scelti tra un range di prodotti testati con l’obiettivo di ottenere le migliori caratteristiche prestazionali, quali la resistenza all’abrasione, allo sfregamento e alla resistenza alla luce artificiale. Sono disponibili categorie di tessuti ignifughi e rivestimenti in finte pelli.

Piccole Accortezze: pulire le Pelli con un panno bianco umido di sola acqua. Per la pulizia dei tessuti consultare la scheda tecnica specifica.

#### IMBALLI E RICICLO

I nostri imballi sono realizzati con l’obiettivo di ottimizzare trasporti e stoccaggio: sono realizzati per il 90% di materiali riciclati e totalmente riciclabili. L’ottimizzazione dell’imballo in termini di volume e peso comporta un minore dispendio di energia, con un conseguente risparmio nei costi di trasporto e un importante aiuto alla salvaguardia del nostro Ambiente Naturale. E’ consigliabile lo smaltimento degli imballi solo a completamento dell’assemblaggio, onde evitare lo smarrimento di eventuale ferramenta e componenti. Una volta dismesso, il prodotto o i suoi componenti vanno conferiti ai sistemi pubblici di smaltimento secondo quanto previsto dalla legislazione locale in vigore.

#### USO IMPROPRIO DEI PRODOTTI

Sono da considerarsi usi impropri e/o scorretti del prodotto il salire in piedi su tavoli, sedie, sgabelli, poggiapiedi, sedersi su schienali, braccioli, utilizzare i prodotti come scaletta. Evitare oscillazioni che potrebbero pregiudicare il funzionamento e la sicurezza dell’utente. Per sollevare o spostare un prodotto non afferrare sotto il sedile, bensì afferrare saldamente la struttura portante. Il prodotto non deve essere sottoposto a carichi decentrati, è stato progettato per essere utilizzato in condizioni normali di appoggio (su quattro gambe o sulla base). Gaber® declina ogni responsabilità per danni causati a cose o a persone derivanti da uso non corretto del prodotto; l’azienda inoltre si solleva da ogni responsabilità per danni provocati su pavimenti e superfici delicate o tenere.



#### DOCUMENTACION GABER®

Toda la documentación Gaber® contiene una serie de informaciones técnicas y consejos para el utilize para quién quiera comprar o para quién posea productos pertenienieces a la gama Gaber®. En el interés de los clientes, Gaber® se reserva el derecho de poder modificar o mejorar sus productos sin avisar antes.

Los dibujos, las medidas, los materiales y los colores se ilustran exclusivamente a modo de ejemplo y son indicativas, sujetos a tolerancias. Las tonalidad de los colores del muestrario relativas a las telas, pieles, pintura, esencias de las maderas, pueden variar según partida.

Gaber® declina todo tipo de responsabilidades con relación a pequeñas diferencias de color. Gaber® se reserva además el derecho de retirar, suspender o cesar la producción de cualquier producto en cualquier momento y a propia discreción sin dar previo aviso.

Todos los derechos de reproducción, incluso parcial, de los catálogos y listas de precios Gaber® relativos a los textos, imágenes, ilustraciones, diseños ya sea por medios mecánicos o electrónicos, incluyendo el fotocopiado o la formación de fuentes de información, sin el permiso previo por escrito de Gaber®, son reservados a nivel mundial.

#### MATERIALES, USO Y MANTENIMIENTO

##### Material Plástico

Tecno Polímeros compuestos que Gaber® utiliza en sus productos se caracterizan por una alta resistencia estructural, al calor y una alta resistencia a la abrasión. Los Tecno Polímero de Gaber® no son tóxicos, son resistentes a manchas, antiestáticos y UV-resistente: gracias a esto los materiales tienen una excelente resistencia a los agentes atmosféricos. Todos estos materiales son reciclables en el pleno respeto de nuestro medio ambiente. Gaber® produce plástico inyectado sin productos químicos y materiales añadidos y, cuando sea posible, tecnopolímero reciclados se obtienen como materia prima básica, recuperado de post-consumo.

Pequeñas atenciones a: Para mantener los productos de tecnopolímero de Gaber en perfectas condiciones y garantizar una calidad duradera de las materias primas, recomendamos seguir unas instrucciones de cuidado muy básicas. Consejos de limpieza: Las superficies de tecnopolímero generalmente deben limpiarse con un paño normal y agua tibia; para las manchas más persistentes se puede utilizar una pequeña cantidad de jabón líquido diluido en agua. Recomendamos evitar estrictamente todo tipo de sustancias abrasivas, como, por ejemplo, productos de limpieza en polvo, cremas, estropajos y esponjas rugosas. Los productos de tecnopolímero de Gaber se pueden desinfectar con diferentes sustancias. Para obtener más información, consulte en la web “compatibilidad de resistencia a productos químicos de polipropileno”; el uso de estas sustancias también depende de la temperatura, presión y concentración. Siempre es una buena práctica, después de desinfectar los productos de tecnopolímeros con estas sustancias, enjuagar inmediatamente los productos con agua. Cualquier fracción de líquido sobre el producto debe ser borrado de inmediato. Incluso los productos hechos especialmente para el exterior podrían ser afectados por los agentes atmosféricos. Productos podrían someterse a posibles cambios en la exposición especial al calor, la humedad y la salinidad. En casos excepcionales y para una vida larga, los productos podrían cambiar de tonalidad y sombra, si se expone a fuerte luz solar directa. Un mantenimiento y limpieza adecuada y frecuente de los productos aumenta su durabilidad. Mantenimiento tiene que llevarse a cabo por personal de experiencia.

Los tapónes de los productos Gaber® están hechos de un compuesto de goma de alta resistencia al desgaste, que reduce el ruido de arrastre. Algunos productos Gaber® están equipados con tapónes con fieltro, adecuados para suelos duros y más delicados.

Gaber® fabrica sobre pedido algunos productos de su colección con tecno polimero retardante de fuego: los aditivos que hacen que el producto de plástico sean a prueba de fuego pueden variar sustancialmente la estética y la durabilidad del producto.

##### Acero

Acero de alta resistencia se utiliza para producir las estructuras de las sillas y de las mesas, utilizando tubos cuadrados o redondos, así como barilla sólida. Los productos están disponibles en cromo o acabados pintados. La pintura en polvo epoxi especial, utilizada en muchas estructuras Gaber®, logra una excelente resistencia a los agentes atmosféricos.

##### Aluminio

Gaber® utiliza aluminio, ligero y resistente, para producir estructuras para las sillas y las mesas. Superficies de aluminio pueden ser anodizado, y Gaber® utilizan este tratamiento especial con el fin de aumentar la resistencia a la corrosión.

Pequeñas atenciones a: tanto las superficies de aluminio que acero se deben limpiar con un paño normal y agua tibia. Para las manchas más persistentes se puede usar una pequeña cantidad de jabón líquido suave diluido en agua. Cualquier fracción de líquido sobre el producto debe ser borrado de inmediato. Se recomienda evitar todo tipo de cremas abrasivas o pastas, esponjas abrasivas, cloro, lejía o detergentes fuertes.

##### Las Maderas

Nuestros artículos de madera se producen de acuerdo con la normativa europea vigente en materia de emisiones de formaldehido de los productos a base de madera. Gaber utiliza materias primas de madera que vienen exclusivamente de la cadena de custodia PEFC de materiales certificados.

Pequeñas atenciones a: artículos de madera, siendo materiales naturales, podrían dañarse fácilmente. Las pequeñas impurezas o imperfecciones están dentro del rango estándar de calidad. Superficies de madera moldeada deben ser limpiadas con un paño y agua. Se recomienda secar inmediatamente después del proceso de limpieza.

##### Espumas

Gaber® utiliza en algunos de sus artículos tapizados una espuma de poliuretano inyectada dentro de un molde, toda las espumas no contienen CFC / HCFC (ODP = 0: no contribuyen a la reducción de la capa de ozono de la atmósfera), y son de clase ignifugo 1-IM Uni 9175 siguiendo Normas europeas.

##### Revestimientos: Telas y Piel

Gaber® utiliza tela y piel que pertenecen a una amplia gama de colores y diseños, que son todos probados a fin de lograr las mejores prestaciones, entre las que la resistencia a la abrasión y la luz artificial. Telas ignifugas y para exterior, tapicería en eco-piel, también están disponibles.

Pequeñas atenciones a: limpias pieles con un paño suave con agua. Consulte las especificaciones técnicas de limpieza para las telas.

##### EMPAQUE Y RECICLABILIDAD

La gama de productos Gaber® está constituida por la mayor parte de elementos completamente reciclables. Nuestros embalajes se escalan con el fin de optimizar los requisitos de almacenamiento y de transporte, que están hechos de 90% materia prima reciclada y son totalmente reciclables. La optimización de los embalajes en términos de volumen y peso ofrece un menor consumo de energía en muchas formas, ayudando al medio ambiente y el consiguiente ahorro en los costes de transporte. A fin de evitar la pérdida de componentes, el embalaje debe eliminarse sólo después de completar el montaje de los productos. Una vez que el producto ha sido desmantelado, el propio producto o sus componentes se debe dar a sistema público de reciclaje, de acuerdo con las normas locales.

##### USOS INADECUADO DEL PRODUCTO

Evite cualquier uso inadecuado del producto; no subir/caminar sobre el producto, no se pare en el reposapiés o en los brazos, no sentarse en el espaldar o en el reposabrazos, no utilice la silla como una escalera. El producto no debe ser sometido a pesos desequilibrados, ya que está diseñado para un descanso adecuado en el punto de apoyo (en cuatro patas o en la base). Cuando levante o mueva el producto, manténgalo en la estructura principal y no sólo bajo el asiento. Gaber® aceptará ninguna responsabilidad por los daños y perjuicios causados a bienes o personas posteriores a un manejo incorrecto o inadecuado del producto. Gaber® se libera de cualquier responsabilidad en caso de daños causados a los suelos frágiles.



## DOCUMENTATION GABER®

Notre documentation contient des informations techniques et des conseils pour l’utilisation des produits, pour les futurs clients Gaber® ou pour qui est déjà en possession d’un produit Gaber®. Dans l’intérêt de la clientèle, Gaber® se réserve le droit de modifier ses modèles, à n’importe quel moment, sans aucun préavis.

Les dessins, les descriptions, les cotes, les matériaux et les couleurs du catalogue et du tarif sont purement indicatifset sous réserve des tolérances. Les dimensions en pouce sont indicatives. Les tonalités des couleurs qui sont représentées sur la carte couleur, relatives aux tissus, au cuir, aux polipro, aux essences de bois sont purement indicatives car elles peuvent varier d’un lot à un autre. Gaber® décline toute responsabilité en ce qui concerne toute différence de tonalité.

Gaber® se réserve le droit de retirer, de suspendre ou de cesser la production de tout article, sans aucun préavis. Tout droit de reproduction, même partielle, des catalogue, relatif aux textes, images, illustrations, dessins, par des moyens mécaniques, électroniques, par photocopie, ou autre source d’information, sans le consentement préalable de Gaber®, est réservé.

## MATERIAUX UTILISES ET LEUR ENTRETIEN

### Matière plastique

Les billes de techno-polymer utilisées par Gaber® pour fabriquer ses produits ont les caractéristiques suivantes : résistance structurel thermique et à l’abrasion. Le techno-polymer est non toxique, il est anti statique et anti UV ; ces qualités le rendent très résistant aux agents atmosphériques. Le techno-polymer est entièrement recyclable, dans le respect de la charte écologique. Quelques informations pour l’entretien : les matières plastiques ne doivent pas être en contact avec une source de chaleur directe. Le liquide versé sur un plateau doit être immédiatement essuyé, les articles réservés à un usage externe peuvent subir à la longue l’action d’agents atmosphériques, tels que la salinité,l’humidité, les rayons de soleil, qui peuvent en altérer la superficie et la couleur. Nous recommandons un entretien régulier ainsi qu’un nettoyage correcte et fréquent, ce qui augmentera la durée de vie du produit. L’entretien doit être effectué par des personnes expertes.

Les bouchons des produits Gaber® sont faits d’un composé en caoutchouc à haute résistance d’usure, qui réduit aussi le bruit de trainée. Certains produits Gaber® sont équipés de bouchons avec feutre, adaptés aux sols durs et plus délicats.

Gaber® réalise sur demande, certains articles de sa collection, en polymer “ignifugé” ; cependant les additifs qui rendent le produit plastique “ignifugé” peuvent en varier l’esthétique et la résistance.

### Acier

L’acier utilisé pour la fabrication des structures de tables, chaises, et tabourets Gaber® est très résistant. Il est travaillé sous forme de tube à section carrée ou ronde. La finition peut être chromée ou vernis. Le vernissage spécial à époxy, utilisé par Gaber®, a une résistance optimale aux agents atmosphériques.

### Aluminium

L’aluminium anodisé utilisé pour la réalisation de structures de tables, chaises et tabourets augmente la résistance à la corrosion. Conseil d’entretien pour les surfaces en acier et/ou en aluminium: nettoyer avec un chiffon doux, humide, imprégné d’eau chaude. Pour les taches éventuelles, on peut ajouter un peu de détergent à usage domestique. Il est recommandé de bien sécher la surface ensuite. Il ne faut pas utiliser de pate et/ou crème pour métal, il ne faut pas utiliser de chlore, de javel ou autre détergents agressifs. Il ne faut pas utiliser de pate ou d’éponges abrasives, qui pourraient endommager en les rayant, les superficies.

### Bois

Les articles Gaber® avec bois, sont fabriqués selon les norms européennes en vigueur, sans formaldéhyde. (par rapport à l’émission de formaldéhyde). Le matériel utilisé pour la fabrication des articles ALHAMBRA ECO et EPICA ECO est un mélange de sciure de bois rendu compact et dérivant de matériel recyclé. Il n’y a ainsi aucun gaspillage. Le bois étant une matière naturelle, peut, avec le temps et suivant l’expositionà la lumière, subir de légères modifications au niveau de la couleur. Ces produits, de par leur nature, peuvent s’abimer facilement ; nous tenons aussi à préciser que certaines imperfections correspondent à un standard normal de qualité. Il est recommandé enfin, de ne pas approcher la superficie à une source de chaleur directe. Les superficies se nettoient à l’aide d’un chiffon doux, légèrement humide. Sécher toujours ensuite.

### Rembourrage en polyuréthane « flexible »

Le rembourrage de certains articles Gaber® est réalisé en polyurethane « flexible », injecté à froid, sans particules de CFC/HCFC (ODP=0 , ne réduit pas la couche d’ozone), ignifugé en classe 1-IM UNI 9175 / CMHR, selon les normes européennes en vigueur.

### Revêtement : tissus et cuir

Gaber® a au choix une large gamme de couleurs et de trames, choisis parmi des tissus, des cuirs, des ecopelle testés et garantissant une bonne résistance aux frottements, aux abrasions, à la lumière artificielle. Nous avons aussi une gamme de revêtements non feu.

Informations et entretien : nettoyer les peaux avec un chiffon blanc, légèrement humide. Pour l’entretien des tissus, consulter la fiche technique, spécifique.

### EMBALLAGE ET RECYCLAGE

Nos emballages sont conçus de façon à optimiser le transport et le stockage ; ils sont réalisés à 90% avec du matériel recycle et sont complètement recyclables. L’emballage, optimisé au maximum en ce qui concerne son volume et son poids, permet une économie d’énergie, de main d’oeuvre et de cout de port, sans oublier la sauve garde de notre environnement. Il est vivement conseillé de monter complètement l’article Gaber® avant de procéder à l’élimination du carton, ceci, afin d’éviter de perdre la visserie et / ou les divers composants de l’article en question. Lorsqu’un produit Gaber® arrive en fin de vie, il est recommandé de porter les diverses parties qui le compose à la déchèterie, selon la loi du pays en vigueur

### USAGE INCORRECT DES PRODUITS

Les tables, chaises, tabourets ou repose pieds ne sont pas fait pour monter dessus, il ne faut pas s’asseoir sur les dossiers ou les accoudoirs ou se servir de ces articles comme d’un escabeau. Il faut éviter de se balancer d’avant en arrière sur les assises, de façon à éviter les accidents. Pour soulever ou déplacer une chaise ou tabouret, il est recommandé de le prendre par le châssis et non par l’assise. Le produit ne doit pas être soumis à des charges excessives ou décentrées, il a été conçu pour un usage normal de simple appui (sur 4 pieds ou sur pied central).

Gaber® décline toute responsabilité pour les dommages causés à personne ou choses, qui pourraient dériver d’un usage incorrect du produit. L’usine décline aussi toute responsabilité pour les dommages sur parquets ou sol délicats.



## GABER® DOKUMENTATION

Die Dokumentation von Gaber® beinhaltet technische Informationen und Ratschläge zur Nutzung von Gaber® Produkte für Kaufinteressenten bzw. für Besitzer von Artikeln, die zur Produktpalette der Gaber® angehören. Im Interesse der Kunden behält sich Gaber® das Recht vor die eigenen Modelle jederzeit abzuändern, ohne Pflicht zur Vorankündigung. Die Zeichnungen, die Quoten, die Materialien und die Farben der Kataloge und der Preislisten der Gaber® dienen lediglich als Information und unterliegen Toleranzen. Die Maßen, die in Zoll angegeben sind, sind als Richtwerte zu betrachten. Die dargestellten Farböne, auch die in den Farbpaletten, sowie die Stoff-, Leder-, Lack-, Glas- und Holzverkleidungen sind Indikativ, da von Fall zu Fall Änderungen möglich sind. Gaber® lehnt jegliche Verantwortung in Verbindung mit Farbtonabweichungen ab. Gaber® behält sich zudem das Recht vor die Produktion jedes einzelnes Produkts zurückzuziehen, einzustellen bzw. abzutreten. Die Rechte an der Reproduktion von Kataloge und Preislisten der Gaber® in Bezug auf Texte, Bilder, Illustrationen, Zeichnungen, die sowohl mit mechanischen als auch mit elektronischen Mitteln, Kopien inbegriffen, erfolgen sind weltweit der Gaber® vorbehalten und benötigen eine schriftliche Genehmigung der Gaber®.

## VERWENDETE MATERIALIEN UND WARTUNG

### Kunststoffmaterialien

Die von Gaber® benutzte „Technopolymer-Verbindung“ für die Realisierung der eigenen Produkte sind durch hohe strukturelle, thermische und abriebfeste Resistenz gekennzeichnet. Das „Technopolymer“, welcher Bestandteil der Produkte Gaber® ist, ist ungiftig, schmutzabweisend, antistatisch und anti-UV: Eigenschaften, die der Produkte Gaber® eine optimale Resistenz gegen die atmosphärischen Einflüsse verleiht. Die verwendeten „Technopolymer“ sind, in Beachtung der Umwelt, vollständig recycelbar. Gaber® produziert thermoplastische Artikel ohne chemische Zusätze und, wo möglich, wird recyceltes „Technopolymer“ aus wiederverwendeten Altstoffen benutzt.

Richtlinien für die korrekte Verwendung: Richtlinien für die korrekte Verwendung: Um die Technopolymerprodukte von Gaber während der gesamten Zeit in einwandfreiem Zustand zu halten und eine lang anhaltende Qualität der Rohstoffe zu gewährleisten, empfehlen wir hiermit grundlegende Anweisungen zur Pflege. Reinigungshinweise: Technopolymeroberflächen müssen normalerweise mit einem normalen Tuch und warmem Wasser gereinigt werden. Für die hartnäckigsten Flecken kann eine kleine Menge in Wasser verdünnter Flüssigseife verwendet werden. Wir empfehlen, alle Arten von Schleifmitteln, wie z. B. pulverförmige Reinigungsprodukte, Cremes, Scorepads und grobe Schwämme, strikt zu vermeiden. Gabers Technopolymerprodukte können mit verschiedenen Substanzen desinfiziert werden. Weitere Informationen finden Sie im Internet unter „Verträglichkeit der Beständigkeit gegen Polypropylen-Chemikalien“. Die Verwendung dieser Substanzen hängt auch von der Temperatur, dem Druck und der Konzentration ab. Es ist immer eine gute Praxis, nach dem Desinfizieren der Technopolymerprodukte mit diesen Substanzen die Produkte sofort mit Wasser zu spülen. Es sollte zudem nicht mit Schleif- bzw. Lösungsmittel in Kontakt treten oder mit grobe Reinigungsgeräte. Die auf die Produkte Gaber® verschütteten Flüssigkeiten müssen sofort abgetrocknet werden. Produkte, die für den Außenbereich bestimmt sind, erleiden mit der Zeit die wetterbedingten Einwirkungen. Eventuelle oberflächliche Änderungen können aufgrund bestimmter Temperatur-, Feuchtigkeits- oder Salzgehaltsbedingungen auftreten. Eine direkte Sonneneinstrahlung kann eine Farbänderung des Produktes verursachen. Eine korrekte und regelmäßige Wartung und Reinigung erhöht die Haltbarkeit des Produkts. Wartungsmaßnahmen sollten von einem spezialisierten Personal vorgenommen werden. Die Kappen und Schutzvorrichtungen der Gaber®-Produkte sind in einer Gummimischung mit hoher Verschleißfestigkeit gemacht, zur Reduzierung von Schleppgeräuschen. Einige Gaber®-Produkte sind Filzstöpseln ausgestattet, die für starre und empfindlichere Böden geeignet sind.

Gaber® realisiert auf Anfrage einige Produkte der eigenen Kollektion mit feuerfesten „Technopolymer“: die Zusatzstoffe, die das Kunststoffmaterial feuerfest machen, können die Ästhetik und die Resistenz der Produkte grundlegend verändern.

Die Kappen und Schutzvorrichtungen der Gaber-Produkte sind in einer Gummimischung mit hoher Verschleißfestigkeit gemacht, zur Reduzierung von Schleppgeräuschen. Einige Gaber-Produkte sind Filzstöpseln ausgestattet, die für starre und empfindlichere Böden geeignet sind.

### Der Stahl

Bei den Strukturen von Tischen, Stühlen und Hockern wird hochfester Stahl verwendet, diese werden von Gaber® mittels rund- bzw. quadratförmige Röhre realisiert. Die Produkte sind in verchromter oder lackierter Ausführung erhältlich. Die spezielle Lackierung aus Epoxidpulver, die von Gaber® an vielen Strukturen verwendet wird, erreicht eine optimale Resistenz gegen die atmosphärischen Einflüsse.

### Das Aluminium

Gaber® benutzt das Aluminium für die Realisierung der Strukturen von Tischen, Stühlen und Hockern. Mittels einer speziellen Verarbeitung der Oberflächen einiger Produkte Gaber®, des Anodisieren, wird die Korrosionsresistenz erhöht. Richtlinien für die korrekte Verwendung: sowohl die Stahl- als auch die Aluminiumoberflächen müssen mit einem feuchten und weichen Tuch, durchtränkt in heißem Wasser, gereinigt werden. Für die hartnäckigsten Flecken kann man mit Vorsicht eine neutrale flüssige Seife in Wasser verdünnen. Nach der Reinigung sollte die Oberfläche immer mit einem weichen Tuch abgetrocknet werden. Verwenden Sie keine Cremes oder Pasten um die Metalle zu reinigen, sowie kein Chlor, Bleichmittel oder sonstige aggressive Reinigungsmittel. Benutzen Sie auch keine groben Pasten oder schleifende Schwämme, die die Metalloberflächen verkratzen könnten.

### Das Holz

Die Produkte Gaber® mit Holzelemente werden in Übereinstimmung mit den geltenden europäischen Vorschriften bezüglich der Emission von Formaldehyd hergestellt. „Compound-Wood“ ist das besondere Material, das von Gaber® für die Realisierung der Produkte „Alhambra-Eco“ und „Epica-Eco“, verwendet wird. Dieses Material benutzt die Holzfasern aus dem Produktionsprozess, mit welchem Gaber® die Holzelemente herstellt. Es wird nichts verschwendet. Richtlinien für die korrekte Verwendung: Die Holzoberfläche kann mit der Zeit durch die Benutzung oder die Sonneneinstrahlung eine Farbänderung erleiden, da es sich um ein natürliches Material handelt. Zudem sind die Oberflächen, aufgrund Ihrer Natur, leicht zu beschädigen. Einige kleine Unreinheiten und Macken liegen im annehmbaren Qualitätsstandard. Die Holzoberflächen vertragen keine direkte Wärmezufuhr. Reinigen Sie die Holzoberflächen mit einem feuchten und weichen Tuch, durchtränkt in lauwarmes Wasser. Trocknen Sie das Produkt sofort nach der Reinigung.

### Polsterung in flexiblen Polyurethan

Die Polsterung einiger Produkte von Gaber® besteht aus flexiblem Polyurethan, kaltgepresst, ohne CFC/HCFC (ODP=0: es trägt nicht zur Reduzierung der atmosphärischen Ozonschicht bei), selbstlöschend der Klasse 1-IM UNI 9175/CMHR, gemäß der geltenden europäischen Vorschriften.

### Die Bezüge: Stoffe und Leder

Gaber® verwendet Stoffe und Leder, die zu einer umfassenden Palette an Farben und Mustern gehören, die alle aus einer Reihe getesteter Produkte ausgewählt wurden, mit dem Ziel die beste Leistung wie die Abriebfestigkeit und Resistenz gegen künstliches Lichtes zu erzielen. Es sind Kategorien feuerfester Stoffe und künstliche Lederbezüge erhältlich. Richtlinien für die korrekte Verwendung: Reinigen Sie das Leder mit einem weißen Tuch, der nur mit Wasser befeuchtet werden sollte.

### VERPACKUNG UND RECYCLING

Unsere Verpackungen wurden mit dem Ziel realisiert den Lager und Transport zu optimieren. Sie bestehen zu 90% aus recycelten Materialien und sind vollständig recycelbar. Die Optimierung der Verpackung in Bezug auf Volumen und Gewicht führt zu einem geringeren Energieverbrauch, mit einer folgenden Einsparung bei den Transportkosten und einer wichtige Hilfe zum Schutz der Umwelt. Um den Verlust von Bauteilen zu vermeiden, wird es empfohlen die Verpackung erst nach Abschluss der Montage der Produkte zu entsorgen. Nach der Montage kann das Produkt oder seine Bestandteile dem öffentlichen Entsorgungssystem gemäß den geltenden örtlichen Vorschriften übergeben werden.

### UNSACHGEMÄSSE VERWENDUNG DES PRODUKTS

Als eine unpassende bzw. unkorrekte Verwendung des Produkts wird folgendes angesehen: auf Tische, Stühle und Hockern aufstehen, auf Rücken- und Armlehnen niedersetzen, die Produkte als Treppchen zu nutzen. Das Schwenken des Produktes könnte das Produkt oder dessen Funktion beschädigen und die Sicherheit des Nutzers gefährden. Um das Produkt anzuheben oder zu verschieben wird empfohlen es an der Hauptstruktur und nicht unter dem Sitz zu halten. Das Produkt sollte keiner dezentralen Last ausgesetzt sein, da es für die Nutzung in normalen Konditionen geplant wurde. Gaber® übernimmt keine Haftung für Schäden an Sachen oder Personen, die durch unsachgemäße Verwendung des Produkts verursacht wurden. Gaber® lehnt zudem jede Haftung für Schäden an empfindlichen Böden oder Oberflächen ab.





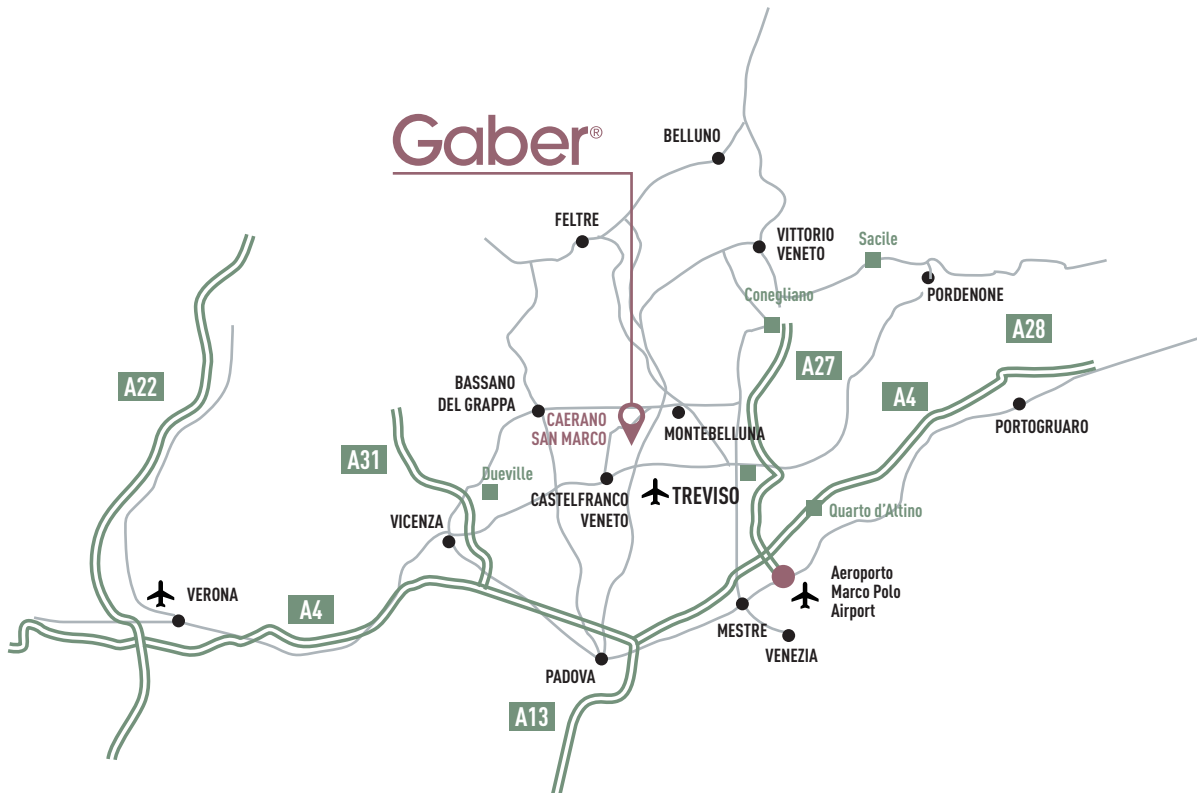

**Gaber**  
Via Altivole, 3  
31031 Caerano San Marco (TV)  
ITALY  
+39 0423 915521  
info@gaber.it  
gaber.it



# Gaber®

visit us on [gaber.it](http://gaber.it)

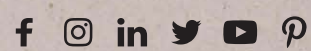

Request  
Gaber  
Literature





**Gaber**<sup>®</sup>  
gaber.it