

**PAOLA
LENTI**

Landscapes Collection

Il progetto d'insieme che Paola Lenti ha realizzato per l'indoor segna l'inizio di un nuovo importante capitolo per l'azienda. Home Collection è oggi una collezione completa, composta da sedute comode e flessibili e da complementi e accessori dai volumi essenziali. Il tessuto lega in un insieme omogeneo elementi architettonici, sedute, contenitori e tavolini, ai quali l'equilibrio fra forma e funzione conferisce un'immagine senza tempo. Volumi, materiali e lavorazioni sono pensati per trasmettere armonia e per arredare spazi dove sia istintiva e naturale la sensazione di tornare finalmente a casa.

The overall project introduced by Paola Lenti for the interiors represents the beginning of an important, new chapter for the Company. Home Collection is today a comprehensive collection of comfortable, versatile seating and essential, easy complements and accessories. The fabric binds together the architectural elements, seating, cabinets and side tables, which maintain a timeless style through the equilibrium between form and function. Volumes, materials and techniques are conceived to convey harmony and to create spaces where the feeling to be back at home arises instinctively and naturally.

SHADING STRUCTURES

Design: Bestetti Associati

Cabanne è un sistema di strutture architettoniche composto dai moduli Quadro, Veranda e Tunnel. Con Cabanne si possono delimitare ampie zone coperte e creare vere e proprie stanze all'aperto. La struttura è in acciaio. I tetti sono in tessuto, legno o alluminio. Le ante laterali fisse o apribili sono in tessuto, legno o vetro. L'uso del tessuto, che scherma e protegge lasciando filtrare aria, luce e calore, rende Cabanne un prodotto unico. I moduli Cabanne sono stati testati secondo le normative NTC, Norme Tecniche delle Costruzioni e resistono a carichi accidentali e a carichi di vento.

Cabanne non è predisposto per impianti elettrici; in caso si desideri creare un allacciamento alla rete, è necessario affidarsi a personale altamente qualificato.

Cabanne is a system of architectural structures composed of Quadro, Veranda and Tunnel modules. Cabanne allows for the creation of large sheltered areas and real open air rooms. The structure is made of steel. Tops are made of fabric, wood or aluminium. The fixed or moving side panels are made of fabric, wood or glass. The use of fabric, that shields and protects yet letting air, light and warmth pass through, makes Cabanne a unique product.

Cabanne modules meet the regulations NTC, Technical Construction Standards and resist to both accidental and wind loads.

Cabanne is not arranged for electrical installations; in case a connection to the grid is required, we recommend to rely only on highly qualified personnel.

Cabanne est un système de structures architecturales composé par les modules Quadro, Veranda et Tunnel. Cabanne permet de délimiter de grandes zones couvertes et de créer de véritables pièces en plein air. La structure est en acier. Les toits sont en tissu, bois ou aluminium. Les vantaux latéraux fixes ou ouvrants sont en tissu, bois ou verre. L'utilisation du tissu, qui cache et protège tout en laissant passer l'air, la lumière et la chaleur, fait de Cabanne un produit unique. Les modules Cabanne sont conformes aux normes NTC, Normes Techniques des Constructions, et résistent aux charges accidentelles et à la charge du vent.

Cabanne n'est pas préparé pour l'installation électrique; au cas où l'on désire créer une connexion au réseau, il est nécessaire de s'adresser à des techniciens professionnels.

Cabanne es un sistema modular de estructuras arquitectónicas componibles. Con los módulos Quadro, Veranda y Túnel se pueden definir grandes áreas cubiertas y crear salas reales al aire libre. La estructura es de acero. El acabado de los techos puede ser en tejido, madera o aluminio; el de los paneles laterales fijos o puertas puede escogerse en tejido, madera o vidrio. El tejido abriga y protege, filtrando el aire, la luz y el calor. Todas estas características hacen de Cabanne un producto único. Los módulos Cabanne cumplen con las reglas NTC, Normas Técnicas de Construcción y pueden soportar cargas accidentales (p.e. nieve) o viento.

Cabanne no tiene canalización para sistemas eléctricos; en caso de que quiera crear una conexión a la red, es necesario contar con profesionales cualificados para implementarla.

Cabanne ist ein System von architektonischen Strukturen bestehend aus Quadro, Veranda und Tunnel Modulen. Mit Cabanne lassen sich große überdachte Flächen und echte Außenräume verwirklichen. Das Gestell ist aus Stahl. Die Dächer sind aus Stoff, Holz oder Aluminium. Die feststehenden oder schwenkbaren Seitenpaneele sind aus Stoff, Holz oder Glas. Der Einsatz von Stoff, welcher zwar schützt und abschirmt aber zugleich auch Luft, Licht und Wärme durchlässt, macht Cabanne zu einem einzigartigen Produkt. Die Cabanne Module erfüllen die Vorschriften NTC, Technische Baunormen und vertragen Verkehrs- und Windlasten.

Cabanne ist nicht für Elektroinstallationen vorgesehen. Im Fall, dass ein Anschluss an das Elektronetz hergestellt werden soll, ist es notwendig, sich nur an hoch qualifiziertes Personal zu wenden.

CABANNE MODULO QUADRO



- 1 **Montanti**, uprights, montants, montantes, Pfosten.
- 2 **Travi**, beams, poutres, vigas, Balken.
- 3 **Traverso**, cross beam, traverse, traversaño, Querbalken.
- 4 **Piastre**, plates, platines, pletinas, Platten.
- 5 **Base HEA**, HEA base, base HEA, base HEA, HEA Basis.

1 Montanti

2 Travi

3 Traverso

I montanti, le travi e il traverso che formano la struttura del modulo Quadro sono sottoposti a un trattamento di zincatura a caldo e a una speciale verniciatura che li rende adatti all'uso anche in condizioni ambientali difficili. Questi componenti sono assemblati fra loro con viti e dadi in acciaio inox. I montanti del modulo sono disponibili in due altezze. L'utilizzo di quelli più alti presuppone la posa di una pavimentazione di finitura, necessaria a riportare la struttura all'altezza corretta per il montaggio delle ante laterali. La struttura del modulo Quadro deve essere fissata a terra in modo permanente su superfici piane che garantiscano un'adeguata resistenza al peso. La struttura è disponibile con piastre di ancoraggio o con base HEA.

4 Piastre

Le piastre devono essere fissate a solette, plinti o cordoli in cemento; possono rimanere a vista o essere coperte con una pavimentazione di finitura.

5 Base HEA

La base HEA garantisce il montaggio del modulo anche dove non esistano manufatti in cemento; per assicurare l'ancoraggio migliore è comunque necessario predisporre punti di appoggio annessi nel terreno e aventi una resistenza alla compressione di almeno 300 kg/cmq.

1 Uprights

2 Beams

3 Cross beam

The uprights, the beams and the cross beam forming the structure of the Quadro module go through a hot dip galvanization treatment and a special varnishing that make them suited to resist also in difficult environments. These components are assembled together with stainless steel bolts and nuts. The uprights are available with two different heights. The use of the higher ones implies the laying of a finishing flooring, that is necessary to bring back the structure to the correct height for the assembly of the side panels. The structure of the Quadro module must be permanently anchored to the ground on level surfaces which must guarantee an appropriate bearing capacity. The structure is available with fixing plates or with HEA base.

4 Plates

The plates must be fixed on concrete slabs, footings or curbs. They can remain visible or be covered by a finishing flooring.

5 HEA base

The HEA base allows for the installation also in absence of a concrete bearing flooring; however, in order to ensure the best anchoring it is highly recommended to prepare anchoring points embedded into the ground and having a load bearing capacity of at least 300 kg/cm².

1 Montants

2 Poutres

3 Traverse

Les montants, les poutres et la traverse qui forment la structure du module Quadro sont protégés par un traitement de galvanisation à chaud et un vernissage spécial qui les rend appropriés pour une utilisation dans des environnements difficiles. Ces composants sont assemblés entre eux par des boulons et des écrous en acier inox. Les montants sont disponibles en deux hauteurs. Les plus hauts sont utilisés lors de la pose d'un plancher de finition, nécessaire pour maintenir la structure à la hauteur correcte pour le montage des vantaux latéraux.

La structure du module Quadro doit être fixée au sol de façon permanente sur des surfaces nivelées qui assurent une résistance suffisante aux poids. La structure est disponible avec platines d'ancrage ou avec base HEA.

4 Platines

Les platines doivent être fixées sur une dalle, des plateformes planes, ou bien sur une corniche en béton; elles peuvent rester visibles ou bien être cachées par un plancher de finition.

5 Base HEA

La base HEA offre la possibilité de monter le module aussi là où des surfaces en béton n'existent pas; afin d'assurer la stabilité de la structure c'est quand même nécessaire de préparer des points d'ancrage noyés dans le sol et ayant une résistance à la compression d'au moins 300 kg/cm².

1 Montantes

2 Vigas

3 Travesaño

Los montantes, las vigas y el travesaño que componen la estructura del módulo Quadro se someten a un tratamiento de galvanización en caliente y a un barnizado especial para adecuarlo a su uso, incluso en condiciones ambientales severas. Todas las tuercas y tornillos utilizados para unir los componentes, son de acero inoxidable. Los montantes del módulo Quadro están disponibles en dos alturas. El uso de los más altos supone la colocación de un pavimento de acabado, necesario para que la estructura tenga la altura correcta para instalar los paneles laterales. La estructura del módulo Quadro se ancla permanentemente al suelo, siempre sobre superficies planas, para garantizar una resistencia adecuada al peso. La estructura está disponible con pletinas de anclaje o con una base HEA.

4 Pletinas

Las pletinas deben anclarse en losas, plintos, o guarniciones de cemento; pueden quedar a la vista o cubrirse con un pavimento de acabado.

5 Base HEA

La base HEA permite el montaje del módulo incluso donde no hay pavimento de cemento; pero, para garantizar el mejor anclaje, es necesario predisponer unos puntos de apoyo enterados en el suelo, con una resistencia a la compresión de al menos 300 kg/cm².

1 Pfoften

2 Balken

3 Querbalken

Alle Pfoften, Balken und Querbalken, die das Modulgestell bilden, werden mit Feuerverzinkung und einer besonderen Lackierung behandelt, die sie auch für den Einsatz unter schwierigen Umweltbedingungen geeignet machen. Diese Komponenten sind mit Schrauben und Muttern aus rostfreiem Stahl zusammengebaut. Die Pfoften sind in zwei Höhen erhältlich. Die höhere werden verwendet, wenn ein zusätzlicher Boden vorgesehen ist, um das Gestell auf die richtige Höhe für die Montage der Seitenpaneele zurückzubringen.

Das Gestell des Moduls Quadro muss auf ebenen Auflageflächen permanent befestigt werden, die einen ausreichenden Gewichtswiderstand gewährleisten müssen. Das Gestell ist mit Befestigungsplatten oder mit HEA-Basis verfügbar.

4 Platten

Die Platten müssen auf Betonboden, -Bordsteine oder -Plinthen befestigt werden. Sie können sichtbar bleiben oder mit einem zusätzlichen Boden abgedeckt werden.

5 HEA Basis

Die HEA-Basis erlaubt die Modulmontage auch bei nicht vorhandenen Betonböden; um eine bestmögliche Verankerung zu gewährleisten, ist trotzdem nötig, in der Erde eingebettete Verankerungspunkte mit einer Tragfestigkeit von mindestens 300 kg/cm² zu vorbereiten.

CABANNE MODULO QUADRO

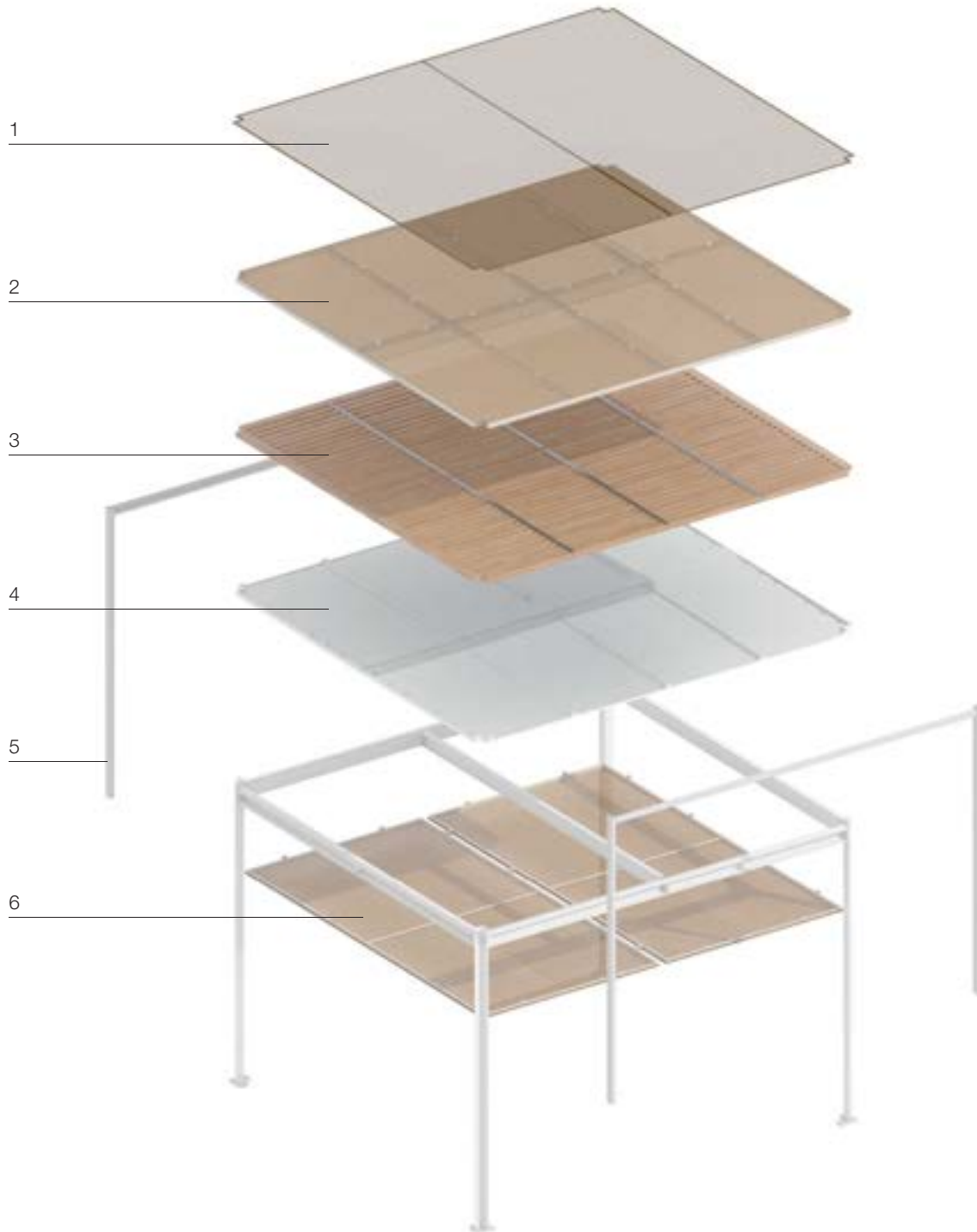

1 **Tetto permeabile in rete di poliestere**, permeable top in polyester net, toit perméable en filet polyester, techo permeable en red de poliéster, Wasserdurchlässiges Dach aus Polywesternetz.

2 **Tetto permeabile in tessuto**, permeable fabric top, toit perméable en tissu, techo permeable en tejido, Wasserdurchlässiges Dach aus Stoff.

3 **Tetto permeabile in legno**, permeable wooden top, toit perméable en bois, techo permeable en madera, Wasserdurchlässiges Dach aus Holz.

4 **Tetto impermeabile in alluminio**, waterproof aluminium top, toit imperméable en aluminium, techo impermeable en aluminio, Wasserundurchlässiges Dach aus Aluminium.

5 **Canaline**, channels, petites canaux, canales, Leitungen.

6 **Sottotetto in tessuto**, fabric false ceiling, faux plafond en tissu, sobretecho en tejido, Zwischendecke auf Stoff.

I tetti del modulo Quadro possono essere realizzati in materiali diversi.

1 Tetto permeabile in rete di poliestere

E' formato da un unico telo in rete di poliestere bianca; ripara dai raggi del sole ma non dalla pioggia; non resiste a carichi accidentali e deve essere smontato in caso di neve o grandine. Questo tetto può essere usato solo in combinazione con il sottotetto in tessuto Thuaia (6).

2 Tetto permeabile in tessuto

E' formato da otto telai in alluminio rivestiti in tessuto Thuaia; ripara dai raggi del sole ma non dalla pioggia e resiste a carichi accidentali fino a un massimo di 20 kg/mq.

3 Tetto permeabile in legno

E' formato da otto pannelli completamente in doghe in massello di sassofrasso e necessita di una adeguata e accurata manutenzione per limitare la naturale deformazione dovuta alla maturazione del materiale; ripara dai raggi del sole ma non dalla pioggia; resiste a carichi accidentali fino a un massimo di 20 kg/mq.

4 Tetto impermeabile in alluminio

5 Canaline

E' formato da due pannelli in alluminio ed è verniciato nello stesso colore della struttura; prevede l'uso di canaline (5) per il deflusso dell'acqua piovana lungo i quattro montanti; ripara dalla pioggia e dai raggi del sole e resiste a carichi accidentali fino a un massimo di 50 kg/mq.

In abbinamento al tetto in alluminio è consigliato l'uso del sottotetto in tessuto Thuaia (6).

Completo di tetto in alluminio e pannelli laterali fissi, il modulo Quadro può resistere a carichi di vento fino a 60 km/h. La sola struttura, completa di tetto ma senza pannelli, resiste a carichi di vento superiori.

6 Sottotetto in tessuto

E' formato da due telai in alluminio rivestiti in tessuto Thuaia.

The tops of the Quadro module can be made of different materials.

1 Permeable top in polyester net

It consists of one layer of white polyester net; it protects from the sun rays but not from the rain; it does not resist to accidental loads and must be removed in case of snow or hailstorm. This top can be used only in combination with the false ceiling in Thuia fabric (6).

2 Permeable fabric top

It is composed of eight aluminium frames covered with Thuia fabric; it protects from the sun rays but not from the rain and withstands accidental loads up to a maximum of 20 kg/m².

3 Permeable wooden top

It is formed by eight panels entirely made of lattices of heartwood Sassafras and requires a regular, thorough maintenance to limit the natural deformation due to the aging of the material; it protects from the sun rays but not from the rain; it withstands accidental loads up to a maximum of 20 kg/m².

4 Waterproof aluminium top

5 Channels

It consists of two aluminium panels and is varnished in the same colour of the structure; it is completed with channels (5) for water outflow positioned along the four uprights; it protects from the rain and the sun rays and withstands accidental loads up to a maximum of 50 kg/m². In combination with the aluminium top, the use of the false ceiling in Thuia fabric is highly recommended.

The Quadro module completed with aluminium top and fixed side panels can withstand wind loads up to 60 km/h. The structure with the same top but without side panels can withstand higher wind loads.

6 Fabric false ceiling

It is formed by two aluminium frames covered with Thuia fabric.

Le toit du module Quadro peut être réalisé en différents matériaux.

1 Toit perméable en filet polyester

Il est formé par une seule toile en filet polyester; il protège du soleil mais non pas de la pluie; il ne résiste pas aux charges accidentelles et doit être démonté en cas de neige ou grêle. Ce toit ne peut être utilisé qu'en combinaison avec le faux plafond revêtu de tissu Thuia (6).

2 Toit perméable en tissu

Il est formé par huit cadres en aluminium revêtus de tissu Thuia; il protège du soleil mais non pas de la pluie et résiste aux charges accidentelles jusqu'à un maximum de 20 kg/m².

3 Toit perméable en bois

Il est formé par huit cadres entièrement en lattes de Sassafras massif et demande un entretien approprié et soigné afin de limiter la déformation naturelle causée par le vieillissement du matériau; il protège du soleil mais non pas de la pluie et résiste aux charges accidentelles jusqu'à un maximum de 20 kg/m².

4 Toit imperméable en aluminium

5 Petits canaux

Il est formé par deux panneaux en aluminium vernis dans le même coloris que celui de la structure; il prévoit l'utilisation de petits canaux (5) pour l'écoulement des eaux de pluie le long des quatre montants; il protège de la pluie et du soleil et résiste aux charges accidentelles jusqu'à un maximum de 50 kg/m².

En combinaison avec le toit en aluminium, on conseille l'application du faux plafond en tissu Thuia (6).

Equipé d'un toit en aluminium et de vantaux latéraux fixes, le module Quadro peut résister à la charge du vent jusqu'à 60 km/h. La seule structure, équipée d'un toit mais sans vantaux, résiste à des charges du vent supérieures.

6 Faux plafond en tissu

Il est formé par deux cadres en aluminium revêtus de tissu Thuia.

Los techos del módulo Quadro pueden fabricarse en distintos materiales.

1 Techo permeable en red de poliéster

Consiste en un único toldo en red de poliéster blanca; protege de los rayos del sol pero no de la lluvia; no soporta cargas accidentales y debe desmontarse en caso de nieve o granizo. Este techo sólo se puede utilizar en combinación con el sobretecho en tejido Thuja (6).

2 Techo permeable en tejido

Consiste en 8 marcos en aluminio recubiertos en tejido Thuia; protege de los rayos del sol pero no de la lluvia y soporta cargas accidentales hasta 20 kg/cm².

3 Techo permeable en madera

Consiste en 8 paneles en listones de sastrás macizo y necesita un mantenimiento cuidadoso para limitar la deformación debida al natural envejecimiento del material; protege de los rayos del sol pero no de la lluvia y soporta cargas accidentales hasta 20 kg/cm².

4 Techo impermeable en aluminio

5 Canales

Consiste en dos paneles de aluminio barnizados en el mismo color de la estructura; tiene 4 canales (5) para evacuar el agua de lluvia a lo largo de los cuatro montantes; protege de la lluvia y de los rayos del sol y soporta cargas accidentales hasta un máximo de 50 kg/m².

En combinación con el techo de aluminio se aconseja el uso de un sobretecho en tejido Thuia (6).

Con el techo de aluminio y paneles laterales fijos, el módulo Quadro puede soportar cargas por viento hasta 60 km/h. La estructura con techo, pero sin paneles soporta cargas por viento superiores.

6 Sobretecho en tejido

Consiste en dos marcos de aluminio recubiertos en tejido Thuia.

Die Dächer des Moduls Quadro können aus verschiedenen Materialien gefertigt werden.

1 Wasserdurchlässiges Dach aus Polyesternetz

Es besteht aus einer einzigen Schicht von Polyesternetz; es schützt vor Sonnenstrahlen aber nicht vor Regen; es verträgt keine Verkehrslasten und muss im Fall von Schnee oder Hagel abgebaut werden. Dieses Dach kann nur in Kombination mit der Zwischendecke aus Thuia Stoff (6) verwendet werden.

2 Wasserdurchlässiges Dach aus Stoff

Es besteht aus 8 mit Thuia Stoff bezogenen Aluminiumrahmen; es schützt vor Sonnenstrahlen aber nicht vor Regen und verträgt Verkehrslasten bis zu maximal 20 kg/m².

3 Wasserdurchlässiges Dach aus Holz

Es besteht aus 8 Paneelen aus Sassafras Massivholzleisten und benötigt eine sorgfältige Wartung, um die natürliche Verformung aufgrund der Alterung des Materials zu begrenzen. Es schützt vor Sonnenstrahlen aber nicht vor Regen; es verträgt Verkehrslasten bis zu maximal 20 Kg/m².

4 Wasserundurchlässiges Dach aus Aluminium

5 Leitungen

Es besteht aus zwei Aluminiumpaneelen und wird in derselben Strukturfarbe lackiert; Leitungen (5) für Regenabfluss werden die vier Pfosten entlang montiert. Es schützt vor Regen und Sonnenstrahlen und verträgt Verkehrslasten bis zu maximal 50 kg/m².

Es wird empfohlen, das Aluminiumdach mit der Zwischendecke aus Thuia Stoff (6) zu ergänzen. Mit Aluminiumdach und festen Seitenpaneelen, widersteht das Modul Quadro Windlasten bis zu 60 km/h. Das einzige Gestell komplett mit dem Dach aber ohne Seitenpaneel, widersteht höheren Windlasten.

6 Zwischendecke aus Stoff

Sie besteht aus zwei mit Thuia Stoff bezogenen Aluminiumpaneelen.

CABANNE MODULO QUADRO



- 1 **Anta in vetro**, glass side panel, vantail en verre, panel lateral en vidrio, Seitenpaneel aus Glas.
- 2 **Anta in tessuto**, fabric side panel, vantail en tissu, panel lateral en tejido, Seitenpaneel aus Stoff.
- 3 **Anta in legno**, wooden side panel, vantail en bois, panel lateral en madera, Seitenpaneel aus Holz.
- 4 **Tenda**, curtain, rideau, cortina, Vorhang.

1 Anta in vetro

2 Anta in tessuto

3 Anta in legno

Al modulo Quadro è possibile applicare ante laterali, fisse o apribili sia verso l'interno sia verso l'esterno. Le ante sono costituite da un telaio strutturale in alluminio verniciato rivestito in tessuto Thuia o completato da doghe in massello di sassofrasso o vetro temperato trasparente extralight.

4 Tenda

In alternativa alle ante, si possono usare tende in tessuto Shade tranne nel caso di strutture con sottotetto in tessuto.

Thuia e Shade sono materiali esclusivi Paola Lenti. Verniciature e tessuti sono disponibili in colori coordinati.

1 Glass side panel

2 Fabric side panel

3 Wooden side panel

The side panels applicable to the Quadro module can be fixed or opening both in and outwards. They are composed of a varnished aluminium frame covered with Thuia fabric or completed with panels in lattices in Sassafras heartwood or extra-light transparent tempered glass.

4 Curtains

As an alternative curtains in Shade fabric can be used, excepted when the structure is finished with a false ceiling.

Thuia and Shade are Paola Lenti's signature materials. Varnishing and fabrics are available in coordinated colours.

1 Vantail en verre

2 Vantail en tissu

3 Vantail en bois

Au module Quadro, on peut appliquer des vantaux fixes ou ouvrants soit vers l'intérieur soit vers l'extérieur. Les vantaux sont composés d'un cadre en aluminium verni et revêtu de tissu Thuia ou complété par des panneaux en lattes de Sassafras massif ou verre trempé extra-light transparent.

4 Rideau

En alternative au vantaux, on peut utiliser des rideaux en tissu Shade excepté le cas où la structure est équipée d'un faux plafond.

Thuia et Shade sont des tissus exclusifs à Paola Lenti. Vernis et tissus sont disponibles en coloris coordonnés.

1 Panel lateral en vidrio

2 Panel lateral en tejido

3 Panel lateral en madera

En el módulo Quadro pueden colocarse paneles laterales fijos o puertas reversibles (apertura hacia fuera y hacia adentro). Los paneles consisten en un marco de aluminio barnizado recubierto en tejido Thuia o también pueden ser de listone de sasafrás macizo o vidrio templado transparente extra-light.

4 Cortina

Alternativamente pueden utilizarse cortinas en tejido Shade, excepto el caso de estructuras completadas con un sobretecho.

Thuia y Shade son materiales exclusivos de Paola Lenti. Barnizados y tejidos están disponibles en colores coordinados.

1 Seitenpaneel aus Glas

2 Seitenpaneel aus Stoff

3 Seitenpaneel aus Holz

Beim Modul Quadro ist es möglich, feste oder nach innen und nach außen schwenkbare Seitenpaneel anzubringen. Die Seitenpaneel bestehen aus einem lackierten Aluminiumrahmen, der mit Thuia Stoff, mit Paneelen aus Sassafras Massivholzleisten oder mit transparentem extra-light und gehärtetem Glas ergänzt wird.

4 Vorhänge

Alternativ, können Vorhänge aus Shade Stoff verwendet werden, außer dem Fall von Strukturen die mit dem Hängedach ergänzt sind.

Thuia und Shade sind exklusive, Materialien von Paola Lenti. Lacke und Stoffe sind in aufeinander abgestimmten Farben erhältlich.

CABANNE MODULO QUADRO



La struttura del modulo Quadro può essere utilizzata con il solo tetto.

The structure of the Quadro module can be used with the top alone.

La structure du module Quadro peut être utilisée avec le toit seulement.

La estructura del módulo Quadro puede utilizarse también sólo con el techo.

Das Gestell von Modul Quadro kann auch nur mit dem Dach verwendet werden.



Al modulo è possibile applicare fino a quattro ante per lato.
The module can be completed with up to four panels per side.
Au module, on peut appliquer jusqu'à quatre vantaux par côté.
Es posible completar el módulo con hasta 4 paneles o puertas por lado.
An das Modul können bis zu 4 Seitenpaneele pro Seite montiert werden.

CABANNE MODULO QUADRO



Al modulo è possibile applicare sia ante fisse sia ante apribili.

The module can be completed with both fixed and moving side panels.

Au module, on peut appliquer soit des vantaux fixes, soit des vantaux ouvrant.

En el módulo pueden colocarse paneles laterales fijos o puertas.

An das Modul können beide feste und schwenkbare Seitenpaneele montiert werden.





Modulo Quadro custom made cm. 400x500. Materials: steel ME002, Thua fabric TH36.











CABANNE MODULO QUADRO, COMPOSITION PROPOSALS

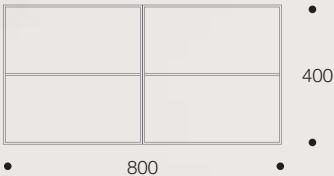



Il modulo Quadro può essere usato in composizione con altri moduli, accostando le diverse unità in linea o nella posizione desiderata.

The Quadro module can be used in compositions with other modules, simply placing the different units side by side or in the desired position.

Le module Quadro peut être utilisé en composition avec d'autres modules, tous simplement l'un à côté de l'autre ou dans la position désirée.

El módulo Quadro se puede utilizar combinado con otros módulos, colocados simplemente uno al lado del otro en línea o en la composición deseada.

Das Modul Quadro kann zusammen mit mehreren Modulen, einfach nebeneinander oder in der gewünschten Komposition, verwendet werden.

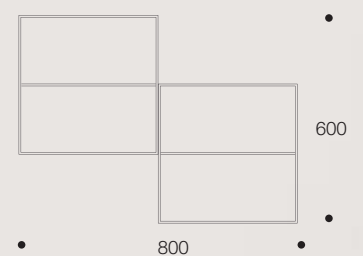









Modulo Quadro. n°2 CA01ABH. Material: steel ME476. n°2 CA01B + n°2 CA01R + n°21 CA01L + n°6 CA01N. Materials: aluminium ME476, Thua fabric TH76.



Tetto portante in tessuto Thuaia, tende in tessuto Shade.
Weight bearing top in Thuaia fabric, curtains in Shade fabric.
Toit portant en tissu Thuaia, rideaux en tissu Shade.
Techo portante en tejido Thuaia, cortinas en tejido Shade.
Tragendes Dach aus Thuaia Stoff, Vorhänge aus Shade Stoff.







CABANNE MODULO VERANDA

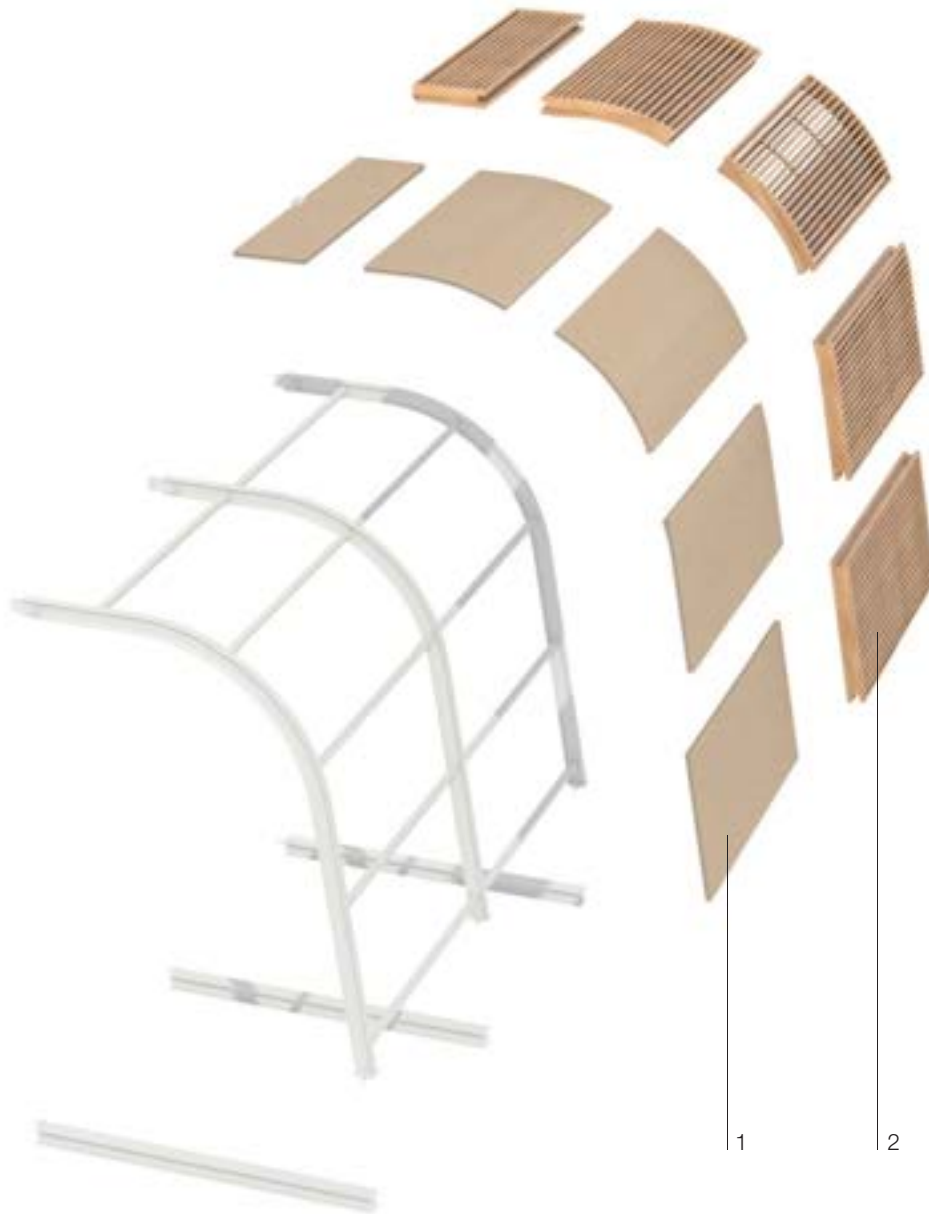

- 1 **Pannelli permeabili in tessuto**, permeable fabric panels, panneaux perméables en tissu, paneles permeables en tejido, Wasserdurchlässige Paneele aus Stoff.
- 2 **Pannelli permeabili in legno**, permeable wooden panels, panneaux perméables en bois, paneles permeables en madera, Wasserdurchlässige Paneele aus Holz.

Il modulo Veranda nasce come estensione del modulo Quadro. La sua struttura deve essere fissata sia al modulo Quadro sia a terra, su superfici piane che garantiscano un'adeguata resistenza al peso.

Le caratteristiche dei materiali usati per realizzare il modulo Veranda, le lavorazioni alle quali sono sottoposti e i sistemi di fissaggio a terra sono gli stessi del modulo Quadro.

I rivestimenti di copertura possono essere realizzati in materiali diversi.

1 Pannelli permeabili in tessuto

Sono realizzati con un telaio in alluminio rivestito in tessuto Thua; riparano dai raggi del sole ma non dalla pioggia e resistono a carichi accidentali fino a un massimo di 20 kg/mq.

2 Pannelli permeabili in legno

Sono realizzati completamente in doghe in massello di sassofrasso e necessitano di una adeguata e accurata manutenzione per limitare la naturale maturazione del materiale; riparano dai raggi del sole ma non dalla pioggia; resistono a carichi accidentali fino a un massimo di 20 kg/mq.

The Veranda module is conceived as an extension of the Quadro module. Its structure must be secured both to the Quadro module and to the ground, on level surfaces which must guarantee an appropriate bearing capacity.

The materials used to produce the Veranda module, the treatments applied to them and the fixing system are the same as the Quadro module.

The finishes are available in different materials.

1 Permeable fabric panels

They consist of an aluminium frame covered with Thua fabric; they protect from the sun rays but not from the rain and withstand accidental loads up to a maximum of 20 kg/m².

2 Permeable wooden panels

They are entirely made of lattices of Sassafras heartwood and require a regular, thorough maintenance to limit the natural deformation due to the aging of the material; they protect from the sun rays but not from the rain and withstand accidental loads up to a maximum of 20 kg/m².

Le module Veranda est conçu comme extension du module Quadro. Sa structure doit être fixée soit au module Quadro, soit au sol, sur des surfaces nivelées qui assurent une résistance suffisante aux poids.

Les caractéristiques des matériaux utilisés pour réaliser le module Veranda, les traitements et les systèmes d'ancrage au sol sont les mêmes que ceux du module Quadro.

Les panneaux de couverture peuvent être réalisés avec des matériaux différents.

1 Panneaux perméables en tissu

Ils sont réalisés avec un cadre en aluminium revêtu de tissu Thua; il protège du soleil mais non pas de la pluie et résistent aux charges accidentelles jusqu'à un maximum de 20 kg/m².

2 Panneaux perméables en bois

Ils sont réalisés entièrement en lattes de Sassafras massif et demandent un entretien approprié et soigné afin de limiter le vieillissement du matériau; ils protègent du soleil mais non pas de la pluie et résistent aux charges accidentelles jusqu'à un maximum de 20 kg/m².

El módulo Veranda se concibió como una extensión del módulo Quadro. Su estructura se debe fijar tanto al módulo Quadro, como a suelo, sobre superficies planas que soporten su peso. Las características de los materiales utilizados para realizar el módulo Veranda, los tratamientos de protección y los sistemas de anclaje a suelo, son los mismos del módulo Quadro. Los paneles que recubren la estructura se pueden realizar con materiales diferentes.

1 Paneles permeables en tejido

Tienen un marco de aluminio recubierto en tejido Thuia; protegen de los rayos del sol pero no de la lluvia y soportan cargas accidentales hasta 20 kg/m².

2 Paneles permeables en madera

Están fabricadas enteramente en listones de safafrás macizo y necesitan un mantenimiento cuidadoso para limitar la deformación debida al natural envejecimiento del material; protegen de los rayos del sol pero no de la lluvia; soportan cargas accidentales hasta 20 kg/m².

Das Modul Veranda ist als Erweiterung des Moduls Quadro entstanden. Sein Gestell muss sowohl am Modul Quadro als auch auf dem Boden auf ebenen Flächen befestigt werden, die eine ausreichende Gewichtswiderstandsfähigkeit gewährleisten.

Die Eigenschaften der verwendeten Materialien, die Materialbehandlungen und die Bodenbefestigungssysteme entsprechen denen des Moduls Quadro.

Die Abdeckpaneele können aus verschiedenen Materialien hergestellt werden.

1 Wasserdurchlässige Paneele aus Stoff

Sie bestehen aus einem mit Thuia Stoff bezogenen Aluminiumrahmen; sie schützen vor Sonnenstrahlen aber nicht vor Regen und vertragen Verkehrslasten bis zu maximal 20 kg/m².

2 Wasserdurchlässige Paneele aus Holz

Sie werden komplett aus Sassafras Massiv-Holzleisten hergestellt und benötigen eine sorgfältige Wartung, um die natürliche Verformung aufgrund der Alterung des Materials zu begrenzen; sie schützen vor Sonnenstrahlen aber nicht vor Regen; sie vertragen Verkehrslasten bis zu maximal 20 kg/m².



Modulo Quadro. CA01ABH. Material: steel ME002. CA01C. Material: Thuia fabric TH36. n°3 CU01H. Material: wood LE002.
Modulo Veranda. CA01FBH. Materials: steel ME002, wood LE002.





Modulo Quadro. CA01ABH. Material: steel ME444. CA01S + n°4 CA01L. Material: Thua fabric TH02.
Modulo Veranda. CA01FTBH. Materials: steel ME444, Thua fabric TH02.



CABANNE MODULO TUNNEL

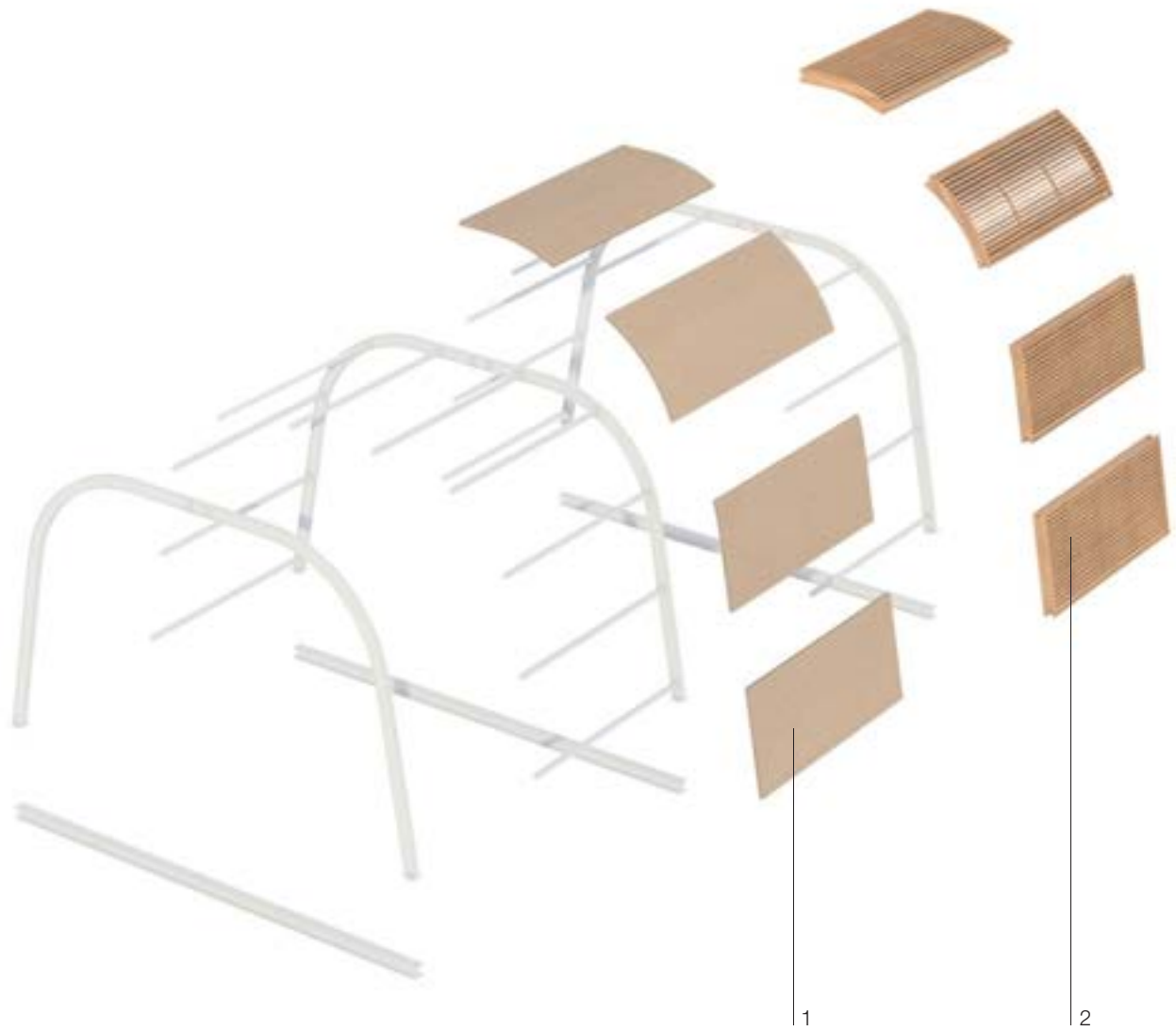

- 1 **Pannelli permeabili in tessuto**, permeable fabric panels, panneaux perméables en tissu, paneles permeables en tejido, Wasserdurchlässige Paneele aus Stoff.
- 2 **Pannelli permeabili in legno**, permeable wooden panels, panneaux perméables en bois, paneles permeables en madera, Wasserdurchlässige Paneele aus Holz.

Le caratteristiche dei materiali usati per realizzare il modulo Tunnel, le lavorazioni alle quali sono sottoposti e i sistemi di fissaggio a terra sono gli stessi del modulo Quadro. I rivestimenti di copertura possono essere realizzati in materiali diversi.

1 Pannelli permeabili in tessuto

Sono realizzati con un telaio in alluminio rivestito in tessuto Thuia; riparano dai raggi del sole ma non dalla pioggia e resistono a carichi accidentali fino a un massimo di 20 kg/mq.

2 Pannelli permeabili in legno

Sono realizzati completamente in doghe in massello di sassofrasso e necessitano di una adeguata e accurata manutenzione per limitare la naturale maturazione del materiale; riparano dai raggi del sole ma non dalla pioggia; resistono a carichi accidentali fino a un massimo di 20 kg/mq.

The characteristics of the materials used to produce the Tunnel module, the treatments applied to them and the fixing system are the same as the Quadro module. The finishes are available in different materials.

1 Permeable fabric panels

They consist of aluminium frames covered with Thuia fabric; they protects from the sun rays but not from the rain and withstand accidental loads up to a maximum of 20 kg/m².

2 Permeable wooden panels

They are entirely made of lattices of Sassafras heartwood and require a regular, thorough maintenance to limit the natural deformation due to the aging of the material; they protects from the sun rays but not from the rain and withstand accidental loads up to a maximum of 20 kg/m².

Les caractéristiques des matériaux utilisés pour réaliser le module Tunnel, les traitements et les systèmes d'ancrage au sol sont les mêmes que ceux du module Quadro. Les panneaux de couverture peuvent être réalisés avec des matériaux différents.

1 Panneaux perméables en tissu

Ils sont réalisés avec un cadre en aluminium revêtu de tissu Thuia; il protègent du soleil mais non pas de la pluie et résistent aux charges ac-

cidentelles jusqu'à un maximum de 20 kg/m².

2 Panneaux perméables en bois

Ils sont réalisés entièrement en lattes de Sassafras massif et demandent un entretien approprié et soigné afin de limiter le vieillissement du matériau; ils protègent du soleil mais non pas de la pluie et résistent aux charges accidentelles jusqu'à un maximum de 20 kg/m².

Las características de los materiales utilizados para realizar el módulo Veranda, los tratamientos de protección y los sistemas de anclaje a suelo son los mismos del módulo Quadro.

Los paneles que recubren la estructura se pueden fabricar en distintos materiales.

1 Paneles permeables en tejido

Tienen un marco de aluminio recubierto en tejido Thuia; protegen de los rayos del sol, pero no de la lluvia y soportan cargas accidentales hasta 20 kg/m².

2 Paneles permeables en madera

Están fabricadas enteramente en listones de sasafrás macizo y necesitan un mantenimiento cuidadoso para limitar la deformación debida al natural envejecimiento del material; protegen de los rayos del sol pero no de la lluvia; soportan cargas accidentales hasta 20 kg/m².

Die Eigenschaften der für die Herstellung des Moduls Tunnel verwendeten Materialien, die Materialbehandlungen und die Bodenbefestigungssysteme entsprechen denen des Moduls Quadro. Die Abdeckpaneele werden aus verschiedenen Materialien hergestellt.

1 Wasserdurchlässige Paneele auf Stoff

Sie bestehen aus einem mit Thuia Stoff bezogenen Aluminiumrahmen; sie schützen vor Sonnenstrahlen aber nicht vor Regen und vertragen Verkehrslasten bis zu maximal 20 kg/m².

2 Wasserdurchlässige Paneele aus Holz

Sie werden komplett aus Sassafras Massiv-Holzleisten hergestellt und benötigen eine sorgfältige Wartung, um die natürliche Verformung aufgrund der Alterung des Materials zu begrenzen; sie schützen vor Sonnenstrahlen aber nicht vor Regen; sie vertragen Verkehrslasten bis zu maximal 20 kg/m².

CABANNE MODULO VERANDA



Il modulo Veranda può essere usato solo in combinazione con il modulo Quadro.

The Veranda module can be used only in combination with the Quadro module.

Le module Veranda ne peut être utilisé qu'en combinaison avec le module Quadro.

El módulo Veranda se puede utilizar sólo in combinación con el módulo Quadro.

Das Modul Veranda kann nur zusammen mit dem Modul Quadro verwendet werden.



Il modulo Tunnel può essere usato singolarmente o in composizione con altri moduli dello stesso tipo.

The Tunnel module can be used alone or in combination with other modules of the same type.

Le module Tunnel peut être utilisé individuellement ou en composition avec des modules du même genre.

El módulo Tunnel se puede utilizar solo o en composición con módulos del mismo tipo.

Das Modul Tunnel kann allein oder in Komposition mit anderen gleichartigen Modulen verwendet werden.







Accostando moduli Tunnel e moduli Quadro si possono creare architetture articolate.

The juxtaposition of Tunnel and Quadro modules allows for the creation of articulated architectures.

La combinaison de modules Tunnel et de modules Quadro permet de créer des architectures articulées.

Combinando módulos Tunnel y módulos Quadro se pueden crear arquitecturas articuladas.

Mit der Kombination von Tunnel und Quadro Modulen lassen sich gegliederte Architekturen verwirklichen.



Modulo Quadro. n°2 CA01ABH. Material: steel ME002. n°2 CA01C + n°6 CA01L. Material: Thuia fabric TH36.
Modulo Tunnel. n°2 CA02ATBH. Materials: steel ME002, Thuia fabric TH36.

Design: m-ar by Renato J. Morganti

Pavilion è una struttura architettonica composta da pannelli esagonali di copertura e da pannelli laterali di supporto. Con Pavilion è possibile proteggere dal sole e dalla pioggia aree di ampie dimensioni, realizzando grandi tende ispirate alla tradizione nomade e dall'aspetto contemporaneo. La cornice del pannello di copertura è realizzata con uno speciale estruso in alluminio. I montanti e i tramezzi che formano la struttura dei pannelli laterali sono in acciaio. I giunti che collegano questi elementi determinano le diverse inclinazioni dei pannelli. Il tessuto di rivestimento è agganciato con un sistema che rende semplici le operazioni di montaggio e smontaggio.

Pavilion è stato testato secondo le normative NTC, Norme Tecniche delle Costruzioni. Se fissato in modo adeguato a superfici portanti, Pavilion garantisce una resistenza a carichi di vento fino a un massimo di 70 km/h; oltre questo limite, i teli di rivestimento si sganciano dalla struttura rimanendo parzialmente ancorati con un attacco di sicurezza. La struttura non è predisposta per impianti elettrici; in caso si desideri creare un allacciamento alla rete, è necessario affidarsi a personale altamente qualificato.

Pavilion è stato selezionato per l'ADI Design Index 2014. Ha vinto l'Interior Innovation Award 2015 istituito dal German Design Council, il MIAW, Muuz International Design Awards 2014 come uno dei prodotti più innovativi del 2013, e il Good Design Awards 2013 nella categoria strutture per l'esterno.

Pavilion is an architectural structure composed of hexagon top panels and support side panels. It allows for the protection of large areas from sun and rain like a tent inspired by the nomadic tradition yet with a contemporary appearance. The top frame is made of a special extruded aluminium. The uprights and the cross beams forming the side panels are made of steel. The joints connecting these elements determine the different inclinations of the panels. The covering fabric is fixed to the structure with a system enabling easy assembly and disassembly operations. Pavilion meets the regulations NTC, Technical Construction Standards. When properly fixed to bearing surfaces, Pavilion is guaranteed to withstand wind loads up to a maximum of 70 km/h; beyond this limit, the covering fabric releases from the structure spontaneously, although remaining partially anchored by means of a safety lock. The structure is not arranged for electrical installations; in case a connection to the grid is required, we recommend to rely only on highly qualified personnel.

Pavilion is included in ADI Design Index 2014. It is winner of the Interior Innovation Award 2014 founded by the German Design Council, the MIAW, Muuz International Design Award 2013 as one of the most innovative products of the year 2013 and the Good Design Award 2013 in the category Outdoor Structures.

Pavilion est une structure architecturale composée de toits hexagonaux et de panneaux de supports latéraux. Pavilion permet de protéger du soleil et de la pluie des zones de grandes dimensions en réalisant des tentes inspirée par la tradition nomade mais d'un dessin contemporain. Le cadre du toit est réalisé en aluminium extrudé spécial. Les montants et les traverses qui forment la structure des panneaux latéraux sont en acier. Les joints qui connectent ces éléments déterminent les inclinaisons différentes des panneaux. Le tissu de revêtement est accroché par un système qui simplifie les opérations d'accrochage et décrochage.

Pavilion est conforme aux normes NTC, Normes Techniques des Constructions. Si elle est proprement fixée sur des surfaces portantes, Pavilion garantit une résistance à la charge du vent jusqu'à un maximum de 70 km/h; au-delà de cette limite, les toiles de revêtement se détachent

de la structure, tout en restant ancrées partiellement à la structure par une attache de sécurité. La structure n'est pas préparée pour l'installation électrique; au cas où l'on désire créer une connexion au réseau, il est nécessaire de s'adresser à des techniciens professionnels. Pavilion a été sélectionné dans le ADI Design Index 2014, a gagné l'Interior Innovation Award 2015, fondé par le Conseil du Design Allemand, le MIAW, Muuuz International Design Award, comme l'un des produits les plus innovants de l'année 2013, et le Good Design Award 2013 dans la catégorie Structures pour l'Extérieur.

Pavilion es una estructura arquitectónica componible, con techos hexagonales y paneles laterales de soporte. Con Pavilion podemos configurar amplias áreas protegidas del sol y de la lluvia; se inspira en las tiendas nómadas pero su aspecto es contemporáneo. El marco del techo es de aluminio extrudido especial. Los montantes y los travesaños que componen la estructura de los paneles laterales son de acero. Las conexiones entre estos elementos establecen las diferentes inclinaciones de los paneles. El tejido de cobertura se aplica mediante un sistema que simplifica las operaciones de montaje y desmontaje. Los paneles laterales de soporte aseguran la estabilidad de la estructura y protegen y abrigan los ambientes creados.

Pavilion cumple con las reglas NTC, Normas Técnicas de Construcción. Si es correctamente fijado sobre superficies portantes, Pavilion puede soportar cargas por viento hasta 70 km/h; más allá de este límite, las lonas de cobertura se desprenden de la estructura, pero permanecen parcialmente anclados mediante una unión de seguridad. La estructura no tiene canalización para sistemas eléctricos; en caso de que quiera crear una conexión a la red, es necesario contar con profesionales cualificados para implementarla.

Pavilion fue seleccionado por el ADI Design Index 2014, obtuvo el galardón Interior Innovation Award 2015 establecido por el German Design Council, el MIAW, Muuuz International Design Award 2014 como uno de los productos más innovadores presentados en 2013, y el Good Design Award 2013 en la categoría "Estructuras para exteriores".

Pavilion ist eine architektonische Struktur aus hexagonalen Dachflächen und Trägerseiten-Paneelen. Mit Pavilion lassen sich große, von der Tradition der Nomaden inspirierte, aber dennoch modern aussehende Zelte zusammensetzen, die große Flächen vor Sonne und Regen schützen. Der Dachrahmen besteht aus speziellem extrudiertem Aluminium. Die Pfosten und Querbalken, die den Rahmen für die Seitenpaneele bilden, bestehen aus Stahl. Die verschiedenen Neigungen der Paneele werden von den Verbindungskupplungen dieser Komponenten bestimmt. Die Bespannung wird mit einem speziellen System verankert, das eine einfache Montage und Abnahme erlaubt.

Pavilion erfüllt die NTC-Vorschriften, Technischen Baunormen und hält Verkehrs- und Windlasten stand. Korrekt an einer Auflagefläche befestigt garantiert Pavilion eine Wind-Beständigkeit von bis zu 70 km/h; über dieser Windgeschwindigkeit hakt die Bespannung vom Gestell aus, bleibt aber im Allgemeinen dank eines Sicherheitsverschlusses sicher verankert. Pavilion ist nicht für Elektroinstallationen vorgesehen. Falls ein Anschluss an das Stromnetz hergestellt werden soll, ist ein qualifizierter Fachmann zu beauftragen.

Pavilion ist im ADI Design Index 2014 gelistet und hat den vom Rat für Formgebung begründeten Interior Innovation Award 2015, den MIAW – Muuuz International Design Award 2014 als eines der innovativsten Produkte des Jahres 2013 und den Good Design Award 2013 in der Kategorie „Outdoor Strukturen“ gewonnen.

PAVILION

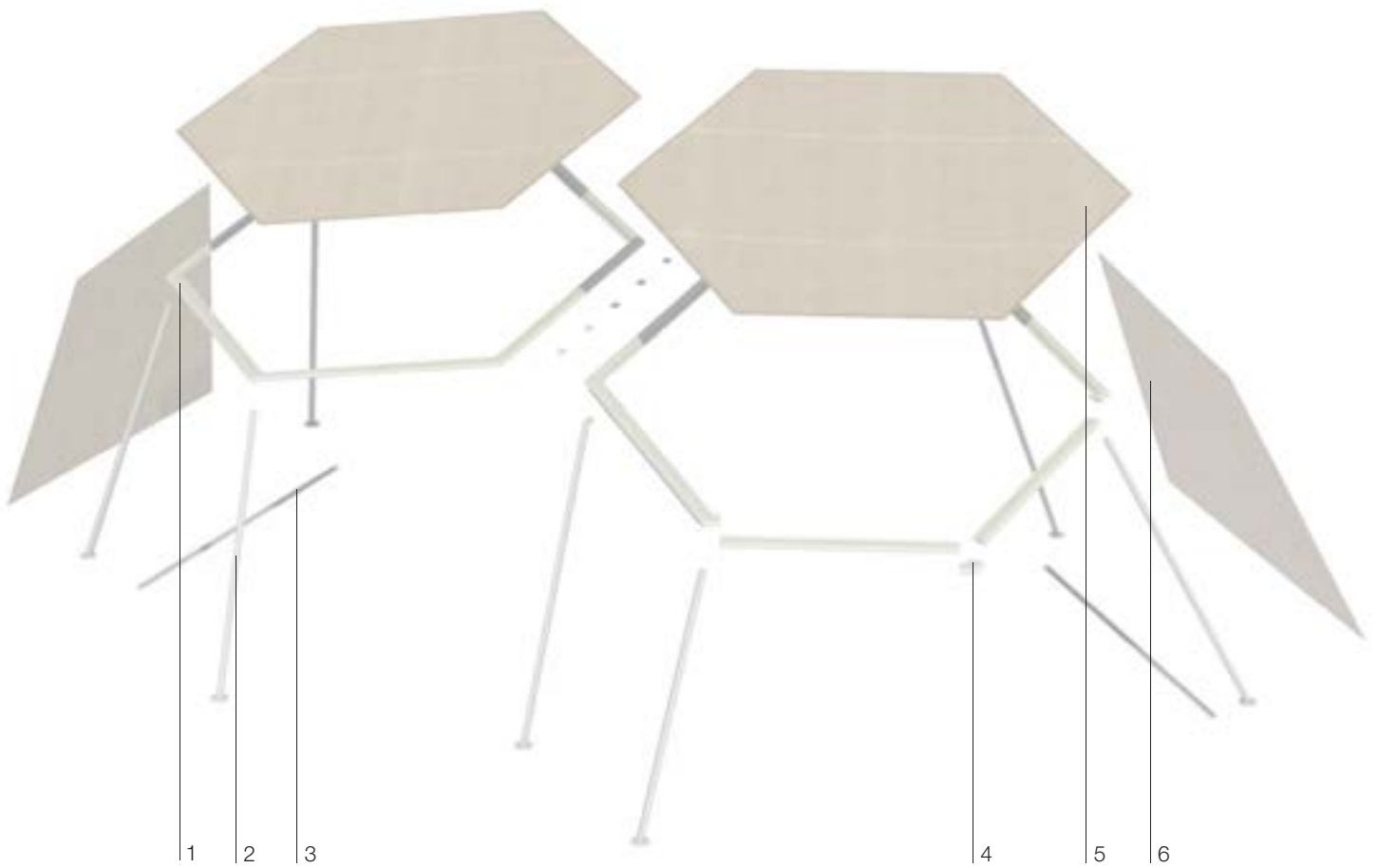

- 1 **Profili**, profiles, profilés, perfiles, Profilen.
- 2 **Montanti**, uprights, montants, montantes, Pfosten.
- 3 **Traversi di base**, basis cross beams, traverses de base, travesaños de la base, Untere Querbalken.
- 4 **Giunti**, joints, jointes, juntas, Kupplungen.
- 5 **Rivestimento impermeabile di copertura**, waterproof top covering, revêtement imperméable du toit, cubierta impermeable de los techos, Wasserstoßende Dachbespannung.
- 6 **Rivestimento impermeabile laterale**, waterproof side covering, revêtement imperméable latéral, cubierta impermeable lateral, Wasserstoßende Seitenbespannung.

1 Profili

2 Montanti

3 Traversi di base

4 Giunti

I profili in alluminio che formano la cornice per il rivestimento di copertura, i montanti e i traversi in acciaio che formano la struttura per il rivestimento laterale sono sottoposti a una speciale verniciatura che li rende adatti all'uso anche in condizioni ambientali difficili. I giunti che collegano i profili e i montanti sono co-stampati in poliuretano e acciaio.

Pavilion deve essere fissato a terra in modo permanente su superfici che garantiscano un'adeguata resistenza al peso. Su superfici portanti, come solette, plinti o cordoli in cemento, le piastre di ancoraggio sono fissate direttamente a terra. Su superfici non portanti, come prati o spiagge, le piastre sono fissate sulla testa di pali elicoidali in acciaio annegati nel terreno. Per assicurare l'ancoraggio migliore è comunque necessario predisporre punti di appoggio aventi una resistenza alla compressione di almeno 300 kg/cmq.

Indipendentemente dal tipo di terreno, il fissaggio della struttura deve essere realizzato con viti in acciaio.

5 Rivestimento impermeabile di copertura

6 Rivestimento impermeabile laterale

Il rivestimento impermeabile degli esagoni di copertura e dei pannelli laterali di supporto può essere realizzato in tela bianca di poliestere o in Madras e Tamil, tessuti esclusivi Paola Lenti.

Verniciature e tessuti sono disponibili in colori coordinati.

Pavilion non è predisposto per sopportare carichi statici accidentali: i teli di copertura e i teli laterali devono essere smontati in caso di neve e nei periodi di non utilizzo. In caso di forti piogge, è possibile far defluire l'acqua piovana dai teli di copertura grazie alle cerniere di cui sono dotati, che permettono il passaggio dell'acqua senza dover smontare il rivestimento in tessuto.

- 1 **Profiles**
- 2 **Uprights**
- 3 **Basis cross beams**
- 4 **Joints**

The aluminium profiles forming the frame of the top panels, the steel uprights and cross beams forming the structure of the side panels are treated with a special varnishing that makes them resistant also in difficult environments. The joints connecting the profiles to the uprights are made of co-moulded steel and polyurethane.

Pavilion must be permanently fixed to the ground on surfaces that guarantee an appropriate bearing capacity. On weight bearing surfaces, such as concrete slabs, footings or curbs, the anchoring plates are directly fixed to the ground. On non-weight bearing surfaces, such as lawns or beaches, the plates are fixed to the head of heavy-duty steel screw-in ground spikes embedded into the ground. However, in order to ensure the best anchoring, it is highly recommended to prepare anchoring points having a resistance to compression of at least 300 kg/cm².

Regardless of the kind of ground, the structure must be fixed with steel screws.

- 5 **Waterproof top covering**
- 6 **Waterproof side covering**

The waterproof covering of the hexagon tops and the side fabric support panels is available either in white polyester fabric or in Paola Lenti's signature fabrics Madras or Tamil.

Varnishing and fabrics are available in coordinated colours.

Pavilion is not designed to withstand accidental loads: the top and side covering fabric must be taken off in case of snow or during periods of non-use. In case of heavy rains, it is possible to drain rain water from the fabric covering thanks to the existing zippers which allow for water outflow without the need to take the covering off.

- 1 **Profils**
- 2 **Montants**
- 3 **Traverses de base**
- 4 **Jointes**

Les profilés en aluminium qui forment le cadre pour le revêtement de la structure, les montants et les traverses en acier qui forment la structure pour le revêtement latéral sont protégés par un vernis spécial qui les rend appropriés pour une utilisation dans des environnements difficiles. Les joints d'assemblage des profilés et des montants sont en polyuréthane et acier moulés ensemble.

Pavilion doit être fixée au sol de façon permanente sur des surfaces qui assurent une résistance suffisante aux poids. Sur des surfaces fermes, telles que des dalles, des plateformes planes, ou des corniches en béton, les platines d'ancrage sont fixées directement au sol. Sur des surfaces meubles, telles qu'une pelouse ou une plage, les platines sont ancrées sur la tête de pieux hélicoïdaux en acier noyés dans le sol. Afin d'assurer l'ancrage le meilleur, il est nécessaire de préparer des points d'appui ayant une résistance à la compression d'au moins 300 kg/cm².

Quel que soit le type de sol, l'ancrage de la structure doit être réalisé avec des vis en acier.

- 5 **Revêtement imperméable du toit**
- 6 **Revêtement imperméable latéral**

Le revêtement imperméable des toits hexagonaux et des panneaux latéraux de support est disponible soit en toile blanche polyester soit en Madras ou Tamil, tissus exclusifs à Paola Lenti. Vernis et tissus sont disponibles en coloris coordonnés.

Pavilion ne résiste pas aux charges accidentelles: les toiles de revêtement des toits et des panneaux latéraux doivent être démontées en cas de neige ou de non-utilisation. En cas de nécessité, les eaux de pluie peuvent s'écouler des toiles grâce aux fermetures éclairées dont les toiles sont équipées, qui permettent le passage de l'eau sans aucun besoin de démonter les revêtements.

1 Perfiles

2 Montantes

3 Travesaños de la base

4 Juntas

Los perfiles en aluminio que forman los marcos para el revestimiento de cubierta. Los montantes y los travesaños en acero que forman la estructura para el revestimiento lateral se someten a un barnizado especial para adecuarlo a su uso, incluso en condiciones ambientales severas. Las juntas que conectan los perfiles y los montantes son co-moldeados en poliuretano y acero.

Pavilion se ancla permanentemente al suelo, siempre sobre superficies que garantizan una resistencia adecuada al peso. Sobre superficies portantes como losas, plintos, o guarniciones de cemento, las pletinas de anclaje se fijan directamente a tierra. Sobre superficies no portantes, como prados y playas, las pletinas se fijan sobre la cabeza de unos polos helicoidales enterrados en el suelo. Para garantizar el mejor anclaje, es siempre necesario predisponer unos puntos de apoyo con una resistencia a la compresión de al menos 300 kg/cm².

Independientemente del tipo de terreno, el anclaje de la estructura se realiza con tornillos de acero.

5 Cubierta impermeable de los techos

6 Cubierta impermeable lateral

La cubierta impermeable de los techos hexagonales y de los paneles laterales de soporte se puede realizar en tela blanca de poliéster o en Madras y Tamil, tejidos exclusivos de Paola Lenti. Barnizados y tejidos están disponibles en colores coordinados.

Pavilion no puede soportar cargas accidentales: todas las lonas se deben desenganchar en caso de nieve o cuando no se utilice. En caso de lluvias intensas, el agua puede fluir del techo gracias a las cremalleras existentes, que permiten que el agua fluya sin desenganchar la lona.

1 Profilen

2 Pfosten

3 Untere Querbalken

4 Kupplungen

Die Aluminiumprofilen, die das Rahmen für die Dachbespannung bilden, die Pfosten und die Querbalken aus Stahl, die das Gestell der Seitenpaneele bilden, sind mit einer besonderen Lackierung versehen, die sie auch für den Einsatz unter rauen Bedingungen geeignet macht. Die Kupplungen, die die Profilen und die Pfosten verbinden, bestehen aus Stahl-Polyurethan-Verbundelementen.

Pavilion muss auf Auflageflächen mit ausreichender Tragfähigkeit dauerhaft befestigt werden. Auf tragfähigen Untergründen, wie Betonböden, -steinen oder -platten, werden die Verankerungsplatten direkt auf dem Boden fixiert. Auf nichttragenden Flächen, wie Rasen oder Stränden, werden die Platten auf den Köpfen von im Boden versenkten großen Erdspießen befestigt. Um eine optimale Verankerung zu gewährleisten, sind Verankerungspunkte mit einer Tragfähigkeit von mindestens 300 kg/cm² vorzusehen.

Unabhängig von der Art des Bodens muss das Gestell mit Stahlschrauben befestigt werden.

5 Wasserstoßende Dachbespannung

6 Wasserstoßende Seitenbespannung

Die Bespannung der hexagonalen Dachflächen und der Seitenpaneele besteht aus weißem Polyesterstoff oder aus Madras bzw. Tamil Stoff; letztere sind exklusive Stoffkreationen von Paola Lenti.

Lacke und Stoffe sind in aufeinander abgestimmten Farben erhältlich.

Pavilion verträgt keine Verkehrslasten: die Top- und Seitenstoffbespannung muss bei Schnee oder längerem Nichtgebrauch ausgehakt werden. Bei starkem Regen ist der ungehinderte Regenabfluss von der Dachbespannung dank der vorhandenen Reißverschlüsse möglich, die den Wasserablauf ermöglichen, ohne den Bespannungsstoff aushaken zu müssen.

PAVILION



Esagono di copertura singolo senza pannelli laterali.
Single hexagonal top without side panels.
Toit hexagonal simple sans panneaux latérales.
Techo hexagonal individual sin paneles laterales.
Einzelne hexagonale Dachfläche ohne Seitenpaneele.

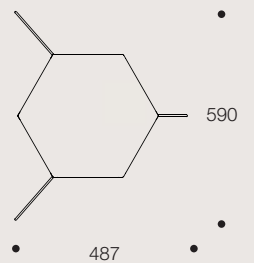



Le composizioni sono disponibili con uno, due o tre esagoni di copertura.
The compositions are available with one, two or three hexagonal tops.
Les compositions sont disponibles avec un, deux ou trois toits hexagonaux.
Las composiciones están disponibles con uno, dos o tres techos hexagonales.
Die Kompositionen sind mit einer, zwei oder drei hexagonalen Dachflächen erhältlich.

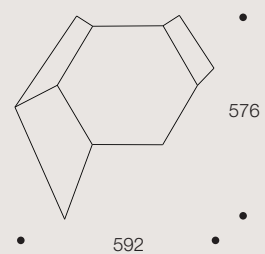

PAVILION



Le composizioni sono articolate secondo schemi fissi.
The compositions are built according to pre-established schemes.
Les compositions sont articulées selon des schémas fixes.
Las composiciones están articuladas en un patrón preestablecido.
Die Kompositionen werden einer festen Anordnung folgend aufgebaut.

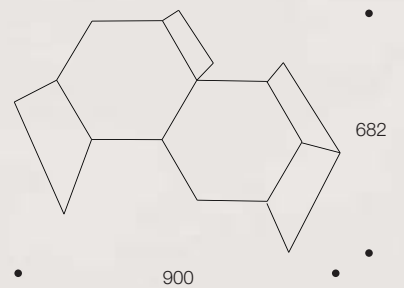

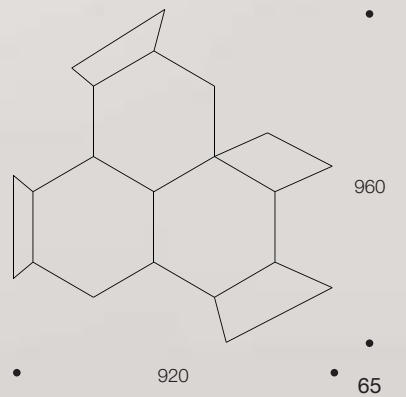

PAVILION



In tutte le composizioni è possibile aumentare il numero dei pannelli laterali.
In each composition, it is possible to increase the number of side panels.
En toute composition il est possible d'augmenter le nombre des panneaux latéraux.
En todas las composiciones se puede aumentar el número de paneles laterales.
Bei allen Kompositionen ist es möglich, die Menge der Seitenpaneele zu erhöhen.

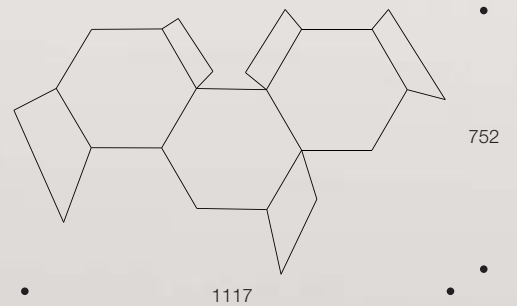









CA16B. Materials: steel ME002, white polyester fabric.















Design: Bestetti Associati

Ala è una vela ombreggiante dall'aspetto essenziale, composta da una copertura in tessuto sospesa fra due supporti in acciaio. Con Ala è possibile proteggere dal sole e delimitare in modo informale ampie zone all'aperto.

La posizione e l'inclinazione dei supporti e la curva del telo di copertura rendono Ala una presenza dinamica e flessibile, che si integra con naturalezza nell'ambiente in cui viene collocata. Il telo di copertura è disponibile sia intero sia composto da quattro elementi indipendenti. Le due tipologie offrono prestazioni differenti e sono state studiate per permettere di installare Ala in situazioni e luoghi con condizioni climatiche e carichi di vento molto diversi.

Ala è stata testata secondo le normative NTC, Norme Tecniche delle Costruzioni. Non è predisposta per impianti elettrici; in caso si desideri creare un allacciamento alla rete, è necessario affidarsi a personale altamente qualificato.

Ala is a shading sail with an essential appearance, composed of a fabric covering suspended between two steel supports. Ala protects from the sun and allows for the definition of large informal outdoor areas.

The position and inclination of the supports and the blend of the covering make Ala a dynamic and flexible presence, which integrates naturally in the environment.

The covering fabric is available either in one piece or composed of four independent elements. The two typologies offer different performances and have been conceived to allow for the installation of Ala in environments and places featuring very different climates and wind conditions. Ala meets the regulations NTC, Technical Construction Standards. It is not designed for electrical installations; in case a connection to the grid is required, we recommend to rely only on highly qualified personnel.

Ala est une voile ombrante au dessin contemporain, composée par une toile suspendue entre deux supports en acier. Ala protège du soleil et permet de délimiter de façon informelle de grands espaces extérieurs.

La position et l'inclinaison des supports et la courbure de la toile font d'Ala une présence dynamique et flexible, qui s'intègre naturellement dans l'environnement où elle est implantée.

La toile de couverture est disponible soit en une seule pièce, soit composée par quatre éléments indépendants. Les deux typologies offrent des performances différentes et ont été conçues afin

de permettre l'installation d'Ala dans des situations et des lieux caractérisés par des conditions climatiques et de vents très différentes.

Ala est conforme aux normes NTC, Normes Techniques des Constructions. Ala n'est pas préparée pour l'installation électrique; au cas où l'on désire créer une connexion électrique, il est nécessaire de s'adresser à des techniciens professionnels.

Ala es una estructura esencial, para dar sombra, compuesta por una cobertura en tejido suspendida entre dos soportes de acero. Con Ala se pueden sombrear y definir grandes zonas de exterior, con un estilo informal.

La posición y la inclinación de los soportes y la curva de la vela de cobertura hacen de Ala una presencia dinámica y flexible, que se integra con naturaleza, allá donde se instale. La vela de cobertura está disponible tanto en una pieza única, como dividida en cuatro elementos independientes. Las dos tipologías ofrecen prestaciones distintas y se han diseñado para instalar Ala en situaciones y lugares con condiciones climáticas y de viento muy diferentes.

Ala cumple con las reglas NTC, Normas Técnicas de Construcción. No tiene canalización para sistemas eléctricos; en caso de que quiera crear una conexión a la red, es necesario contar con profesionales cualificados para implementarla.

Ala ist ein schlichtes Sonnensegel bestehend aus einem Stoffsegel, die zwischen zwei Stahl-Trägern eingehängt wird. Ala bietet Schutz vor der Sonne und ermöglicht die informelle Abgrenzung von großen Außenbereichen.

Die Position und die Neigung der Träger und die Durchbiegung des Segels verleihen Ala ein dynamisches und flexibles Erscheinungsbild.

Das Sonnensegel ist entweder in einem einzigen Stück oder mit vier voneinander unabhängigen Elementen verfügbar. Diese zwei Konstruktionstypen bieten verschiedene Einsatzmöglichkeiten und wurden speziell entwickelt, um Ala in Situationen und Umgebungen mit unterschiedlichen Klima- und Windbedingungen installieren zu können.

Ala erfüllt die NTC-Vorschriften, Technischen Baunormen. Ala ist nicht für Elektroinstallationen vorgesehen; Falls ein Anschluss an das Stromnetz hergestellt werden soll, ist ein qualifizierter Fachmann zu beauftragen.



- 1 **Montanti**, uprights, montants, montantes, Pfosten.
- 2 **Giunti**, joints, joints, juntas, Kupplungen.
- 3 **Traversi**, cross beams, traverses, traversaños, Querbalken.
- 4 **Piastre**, plates, platines, pletinas, Platten.
- 5 **Base HEA**, HEA base, base HEA, base HEA, HEA Basis.
- 6 **Telo di copertura**, fabric covering, toile de couverture, vela de cobertura, Stoffsegel.

1 Montanti

2 Giunti

3 Traversi

I supporti di Ala sono formati da due montanti, due giunti e un tramezzo in acciaio inox; sono sottoposti a una speciale verniciatura che li rende adatti all'uso anche in condizioni ambientali difficili. Montanti e tramezzo sono assemblati fra loro con viti in acciaio inox.

Ala deve essere fissata a terra in modo permanente su superfici che garantiscano un'adeguata resistenza al peso. I supporti sono disponibili con piastre di ancoraggio o con base HEA.

4 Piastre

Su superfici portanti, come solette, plinti o cordoli in cemento, le piastre di ancoraggio sono fissate direttamente a terra e rimangono a vista.

5 Base HEA

Su superfici non portanti, come prati o spiagge, è necessario usare la base HEA.

Per assicurare l'ancoraggio migliore è comunque necessario predisporre punti di appoggio annegati nel terreno e aventi una resistenza alla compressione di almeno 300 kg/cmq.

6 Telo di copertura

Il telo di copertura intero è impermeabile. Può essere realizzato in tela bianca di poliestere o in Madras e Tamil, tessuti esclusivi Paola Lenti. Il telo è agganciato con moschettoni in acciaio a un meccanismo scorrevole inserito nel tramezzo di unione dei montanti.

Il telo non resiste a carichi accidentali; la possibilità di essere richiuso senza essere smontato permette di mettere Ala in sicurezza in caso di neve, grandine, forte pioggia o vento. Per tendere il telo e far sì che il meccanismo scorrevole funzioni correttamente, è necessario regolare l'inclinazione dei montanti. Il telo intero è stato studiato in modo da avere la giusta inclinazione per favorire il deflusso dell'acqua piovana in un punto preciso. Se la struttura di Ala è fissata a terra su superfici portanti, il telo di copertura intero resiste a carichi di vento fino a un massimo di 50 km/h, limite oltre il quale è sempre consigliato richiuderlo. Verniciature e tessuti sono disponibili in colori coordinati.

1 Uprights

2 Joints

3 Cross beams

The supports of Ala are composed of two uprights, two joints and a cross beam in stainless steel; they are treated with a special varnishing that make them suited to resist also in difficult environments. Uprights and cross beam are joined together by means of stainless steel screws.

Ala must be permanently anchored to the ground on surfaces which guarantee an appropriate bearing capacity. The supports are available with anchoring plates or with HEA base.

4 Plates

On weight bearing surfaces, such as concrete slabs, footing and curbs, the anchoring plates are directly fixed on the ground and remain visible.

5 Base HEA

On non-weight bearing surfaces, such as lawns and beaches, it is necessary to use the HEA base.

However, in order to ensure the best anchoring, it is highly recommended to prepare anchoring points embedded into the ground and having a compressive strength of at least 300 kg/cm².

6 Fabric covering

The covering in one single piece is water repellent. It is available either in white polyester or in Paola Lenti's signature fabrics Madras or Tamil. The sail is hooked by means of steel snap hooks to a sliding mechanism inserted in the cross beam connecting the uprights. The sail does not withstand accidental loads; the possibility to close the sail without removing it allows for the securing of Ala in case of snow, hail, heavy rain or strong wind. To tension the sail and make sure that the sliding mechanism works properly, it is necessary to adjust the uprights inclination.

The sail in one piece has been designed in order to have the right angle for the rainwater outflow in a precise point. When the structure of Ala is fixed on weight bearing surfaces, the sail in one piece withstand wind loads up to a maximum of 50 km/h, beyond which it is always recommended to close it. Varnishing and fabrics are available in coordinated colours.

1 Montants

2 Joints

3 Traverses

Les supports de Ala sont composés par deux montants, deux joints et une traverse en acier inox; ils sont protégés par un vernis spécial qui les rend propre à une utilisation dans des environnements difficiles. Les montants et la traverse sont assemblés entre eux par des vis en acier inox.

Ala doit être fixée au sol de façon permanente sur des surfaces qui assurent une résistance suffisante aux poids. Les supports sont disponibles avec des platines d'ancrage ou avec une base HEA.

4 Platines

Sur des surfaces fermes, telles que des dalles, des plateformes planes, ou des corniches en béton, les platines d'ancrage sont fixées directement au sol et restent visibles.

5 Base HEA

Sur des surfaces meubles, telles qu'une pelouse ou une plage, il faut utiliser la base HEA. Afin d'assurer la stabilité de la structure il est nécessaire de préparer des points d'ancrage noyés dans le sol ayant une résistance à la compression d'au moins 300 kg/cm².

6 Toile de couverture

La toile de couverture entière est imperméable. Elle peut être réalisée en toile blanche polyester ou bien en Madras ou Tamil, tissus exclusifs à Paola Lenti. La toile est accrochée par des mousquetons en acier à un mécanisme glissant inséré dans la traverse d'union des montants. La toile ne résiste pas aux charges accidentelles; la possibilité de la fermer sans le décrocher permet de mettre Ala en sécurité en cas de neige, grêle, pluie ou vents forts.

Pour bien tendre la toile et s'assurer que le mécanisme glissant fonctionne parfaitement, il faut régler l'inclinaison des montants. La toile entière a été dessinée de façon à avoir l'inclinaison correcte pour favoriser l'écoulement des eaux de pluie d'un point précis. Si la structure d'Ala est fixée au sol sur des surfaces fermes, la toile de couverture entière résiste à la charge du vent jusqu'à 50 Km/h; au-delà de cette limite, il est toujours conseillé de fermer la voile. Vernis et tissus sont disponibles en coloris coordonnés.

1 Montantes

2 Juntas

3 Traversaños

Ala se sustenta sobre dos montantes, dos juntas y un travesaño en acero inox; sometidos a un barnizado especial para su uso incluso en condiciones ambientales severas. Los montantes y el travesaño se unen con tornillos en acero inox.

Se ancla permanentemente al suelo, siempre sobre superficies que garantizan una resistencia adecuada al peso. Los soportes están disponibles con pletinas de anclaje o con una base HEA.

4 Pletinas

Sobre superficies portantes, como losas, plintos, o guarniciones de cemento, las pletinas se anclan directamente al suelo y quedan a la vista.

5 Base HEA

Sobre superficies no portantes, como prados y playas, es necesario el uso de la base HEA.

Para garantizar el mejor anclaje, es siempre necesario predisponer unos puntos de apoyo enterrados en el suelo, con una resistencia a la compresión de al menos 300 kg/cm².

6 Vela de cobertura

La vela de cobertura en una pieza única es impermeable. Puede realizarse en tela blanca de poliéster o en Madras o Tamil, tejidos exclusivos de Paola Lenti. La vela esta enganchada con mosquetones de acero a un mecanismo deslizante, instalado dentro del travesaño de unión entre los montantes. La vela no soporta cargas accidentales; la posibilidad de cerrar la vela sin desmontarla permite asegurar Ala en caso de nieve, granizo, fuerte viento o lluvia.

Para tensar la vela y para asegurar que el mecanismo funciona correctamente, es necesario ajustar la inclinación de los montantes.

Esta vela se ha diseñado para tener una inclinación que permite que el agua de lluvia fluya de un punto preciso.

Si la estructura se fija sobre superficies portantes, esta vela soporta cargas por viento hasta un máximo de 50 km/h; más allá de este límite siempre se recomienda cerrarla. Barnizados y tejidos están disponibles en colores coordinados.

1 Pfoften

2 Kupplungen

3 Querbalken

Die Träger von Ala bestehen aus zwei Pfoften, zwei Kupplungen und einem Querbalken aus rostfreiem Stahl; sie werden mit einer besonderen Lackierung behandelt, die sie auch für den Einsatz unter rauen Umgebungsbedingungen geeignet macht. Die Pfoften und der Querbalken werden mit Schrauben aus rostfreiem Stahl verschraubt.

Ala muss auf ausreichend tragfähigen Untergründen dauerhaft befestigt werden. Die Träger sind entweder mit Befestigungsplatten oder mit HEA-Basis erhältlich.

4 Platten

Auf tragfähigen Flächen, wie z.B. Betonböden oder Bordsteinen, werden die Platten direkt auf dem Boden befestigt und bleiben sichtbar.

5 HEA Basis

Bei nicht tragfähigen Untergründen, wie Rasen oder Stränden, ist die HEA Basis zu verwenden. Um eine optimale Verankerung zu gewährleisten, sind in der Erde versenkte Verankerungspunkte mit einer Tragfähigkeit von mindestens 300 kg/cm² vorzusehen.

6 Stoffsegel

Das aus einem Stück bestehende Segel ist wasserundurchlässig. Es kann aus weißem Polyesterstoff bzw. aus Madras oder Tamil gefertigt werden, beides exklusive Stoffe von Paola Lenti. Der Stoff wird mit Stahlhaken in einer Laufschiene befestigt, die im Inneren des Querbalkens verläuft. Das Segel hält keinen Verkehrslasten stand; es lässt sich schließen, ohne es abzubauen, dadurch kann Ala sicher vor Schnee, Hagel, starkem Regen oder Wind geschützt werden.

Zum Spannen des Segels und für die richtige Funktion der Laufschiene ist es nötig, die Neigung der Pfoften entsprechend einzustellen. Das Segel wurde mit einem gewissen Neigungswinkel entwickelt, um die Ableitung des Regenwassers an einer bestimmten Stelle zu begünstigen. Wird das Gestell von Ala fest auf einer Auflagefläche befestigt, widersteht dieses Segel Windlasten bis zu 50 km/h; bei höheren Windgeschwindigkeiten empfehlen wir Ihnen, das Segel zu schließen. Lackierungen und Stoffe sind in aufeinander abgestimmten Farben erhältlich.

ALA



Vela ombreggiante realizzata con telo di copertura intero.

Shading sail with covering in one single piece.

Voile ombrante réalisé avec une toile de couverture en une seule pièce.

Vela de cobertura en una pieza única.

Stoff aus einem einzigen Stück.



Vela ombreggiante realizzata con telo di copertura formato da quattro elementi.

Shading sail with covering composed of four elements.

Voile ombrante réalisée avec toile de couverture en quatre éléments séparés.

Vela de cobertura con cuatro elementos.

Stoff aus vier Stoffelemente.



1

1 Telo di copertura

Il telo di copertura formato da quattro elementi indipendenti può essere realizzato in tela bianca di poliestere o in Madras e Tamil, tessuti esclusivi Paola Lenti. Gli elementi sono collegati alla struttura di Ala con un sistema che permette lo sganciamento veloce in caso di necessità.

Vento e pioggia passano liberamente fra un telo e l'altro; per questo, la copertura formata da quattro elementi garantisce ad Ala una stabilità maggiore anche in presenza di pioggia o vento di particolare intensità. I teli non resistono a carichi accidentali e devono essere smontati in caso di neve, grandine o forte pioggia e nei periodi di non utilizzo.

1 Fabric covering

The covering composed of four independent elements is available either in white polyester or in Paola Lenti's signature fabrics Madras or Tamil. The elements are connected to the structure of Ala by a system allowing for a rapid release in case of need.

Wind and rain pass freely between one canvas and the other; for this reason, the covering composed of four elements guarantee a higher stability of Ala also in case of particularly heavy rain or wind. The coverings do not withstand accidental loads and must be removed in case of snow, hail, heavy rain or during periods of non-use.

1 Toile de couverture

La toile formée par quatre éléments indépendants peut être réalisée en toile blanche polyester ou en Madras ou Tamil, tissus exclusifs à Paola Lenti. Les éléments sont connectés à la structure de Ala par un système qui permet le décrochage rapide en cas de nécessité.

Le vent et la pluie passent librement entre une

toile et l'autre; pour cette raison, la couverture formée par quatre éléments assurent à Ala une stabilité supérieure même en présence de pluie ou vent d'intensité importante. Les toiles ne résistent pas aux charges accidentelles et doivent être démontées en cas de neige, grêle ou pluie forte et dans les périodes de non-utilisation.

1 Vela de cobertura

La vela de cobertura dividida en cuatro elementos independientes se fabrica en tela blanca de poliéster o en Madras o Tamil, tejidos exclusivos de Paola Lenti. Los elementos se unen a la estructura con un sistema que permite su rápido desenganche si es necesario.

Viento y lluvia fluyen libremente entre las lonas; por esto la cobertura compuesta de cuatro elementos asegura una mayor estabilidad de Ala, incluso en caso de lluvia o viento de fuerte intensidad. Las lonas no soportan cargas accidentales y deben desmontarse en caso de nieve, granizo o lluvia intensa y cuando no se utilice.

1 Stoffsegel

Das Stoffsegel aus vier unabhängigen Elementen ist in weißem Polyesterstoff bzw. in Madras oder Tamil erhältlich, beide exklusive Stoffkreationen von Paola Lenti. Die Elemente werden mithilfe eines Systems auf dem Gestell von Ala befestigt, das im Bedarfsfall ein schnelles Ausklinken erlaubt.

Wind und Regen strömen frei zwischen den einzelnen Stoffelementen durch; aus diesem Grund, bietet das in vier Elemente unterteilte Segel eine höhere Standfestigkeit auch bei besonders starkem Regen oder Wind. Die Segel-elemente vertragen keine Verkehrslasten und müssen bei Schnee, Hagel, starkem Regen oder bei längerem Nichtgebrauch abmontiert werden.

















Design: Fattorini+Rizzini+Partners

Resort è una struttura architettonica flessibile che può essere usata sia come un ampio parasole sia per creare percorsi coperti articolati. I moduli sono indipendenti oppure uniti da elementi di raccordo.

Resort ha dimensioni fisse, ma si produce anche su misura fino a un massimo di cinque metri di lunghezza per lato. La struttura dei moduli è composta da profili sagomati uniti da elementi di raccordo. Poggia su basi in ghisa e non deve necessariamente essere fissata a terra in modo permanente. Resort può essere montato e smontato facilmente; può essere spostato secondo necessità o messo completamente al riparo in ambienti chiusi e protetti nei periodi di non utilizzo. La possibilità di rivestire non solo le superfici orizzontali, ma anche i piani laterali verticali, permette di schermare dal sole e dal vento ambienti e zone di passaggio. In condizioni climatiche caratterizzate da piogge intense e frequenti, è consigliato utilizzare gli elementi Resort con la superficie di copertura impermeabile inclinata, che permette il deflusso immediato e costante dell'acqua piovana.

Resort è stato testato secondo le normative NTC, Norme Tecniche delle Costruzioni. Non è predisposto per impianti elettrici; in caso si desideri creare un allacciamento alla rete, è necessario affidarsi a personale altamente qualificato.

Resort is a flexible architectural structure that can be used both as a wide parasol and for the creation of articulated covered passageways. The modules are independent or can be joined together by connecting elements.

Resort is available in standard dimensions but can be also produced in custom sizes up to a maximum length of 5m per side. The structure of the modules is composed by shaped profiles joined by connection elements. It rests on cast iron bases and does not necessarily needs to be permanently fixed to the ground. Resort can be easily assembled and disassembled; it can be moved as needed or completely sheltered in closed and protected spaces when not in use. The possibility to cover not only the horizontal surfaces, but also the vertical side areas, allows for the protection from sunrays and wind of both spaces and passageways. Under climate conditions featured by heavy and frequent rain, it is recommended to use Resort elements with inclined waterproof top surface, that allows for the immediate and constant runoff of rainwaters.

Resort meets the regulations NTC, Technical Construction Standards. It is not prepared for electrical installations; in case a connection to the grid is required, we recommend to rely only on highly qualified personnel.

Resort est une structure architecturale flexible qui peut être utilisée soit comme un grand parasol, soit pour créer des passages couverts et articulés. Les modules sont indépendants ou unis par des éléments de jonction.

Resort est disponible en dimensions standard, mais peut être aussi produit sur mesure jusqu'à un maximum de 5m de longueur par côté. La structure des modules est composée de profilés façonnés unis par des éléments de jonction. Elle repose sur des bases en fonte et ne doit pas être nécessairement fixée au sol de façon permanente. Resort peut être montée et démontée facilement; elle peut être déplacée selon les besoins ou stockée

dans des espaces fermés et protégés dans les périodes de non-utilisation. La possibilité de couvrir aussi bien les surfaces horizontales que les panneaux verticaux, permet de protéger du soleil et du vent les espaces et les passages ainsi créés. Dans les climats caractérisés par des pluies intenses et fréquentes, on conseille d'utiliser les éléments Resort avec la surface de couverture inclinée qui permet l'écoulement immédiat et constant des eaux de pluie. Resort est conforme aux normes NTC, Normes Techniques des Constructions. La structure n'est pas préparée pour l'installation électrique; dans le cas où l'on désire créer une connexion électrique, il est nécessaire de s'adresser à des techniciens professionnels.

Resort es una estructura arquitectónica flexible que puede utilizarse como un amplio parasol o para crear pasillos cubiertos y articulados. Los módulos son independientes, pero pueden unirse por elementos de conexión.

Sus dimensiones son fijas, pero puede producirse también a medida hasta un máximo de cinco metros por lado. La estructura de los módulos se compone de perfiles unidos entre sí por elementos de conexión. Se apoya sobre bases en hierro y no debe necesariamente fijarse al suelo de forma permanente. Resort puede montarse y desmontarse fácilmente; puede trasladarse según necesidad o almacenarse cuando no se utilice. La posibilidad de cubrir no sólo las superficies horizontales, sino también los planos laterales verticales, permite la protección del sol y del viento.

En condiciones climáticas caracterizadas por lluvia intensa y frecuente, se aconseja de utilizar los elementos Resort con cobertura impermeable inclinada, que permite la evacuación veloz y continua del agua de lluvia. Resort cumple con la reglas NTC, Normes Techniques des Constructions.

Resort ist eine flexible, architektonische Konstruktion, die sowohl als breiter Sonnenschirm, als auch zur Überdachung gegliederter Durchgangsbereiche verwendet werden kann. Die Module werden unabhängig voneinander montiert oder mithilfe von Verbindungselementen miteinander verbunden.

Resort hat Standardmaße, kann aber auch in jeder gewünschten Größe bis zu maximal 5 m Länge pro Seite hergestellt werden. Das Gestell der Module besteht aus Formprofilen, die von Verbindungselementen zusammengehalten werden. Es steht auf Sockeln aus Gusseisen und muss nicht unbedingt dauerhaft im Boden verankert werden. Die Resort Module lassen sich ganz einfach montieren und abbauen; sie können nach Belieben versetzt oder bei längerem Nichtgebrauch vollständig in geschlossenen und geschützten Räumen aufbewahrt werden. Durch die Möglichkeit, nicht nur horizontale, sondern auch vertikale Flächen zubeziehen, lassen sich Flächen und Durchgangsbereiche effektiv vor Sonne und Wind abschirmen.

Bei heftigen und häufigen Regenfällen empfiehlt es sich, die speziellen Resort Elemente mit wasserabstoßender, geneigter Dachfläche zu verwenden, die eine unmittelbare und kontinuierliche Ableitung des Regenwassers gestatten.

Resort erfüllt die NTC-Vorschriften, Technische Baunormen. Sie ist nicht für die Elektroinstallation vorgesehen. Falls ein Anschluss an das Stromnetz hergestellt werden soll, ist ein qualifizierter Fachmann zu beauftragen.

RESORT



1 **Montanti**, uprights, montants, montantes, Pfosten.

2 **Profili perimetrali**, perimetral profiles, profilés périmétriques, perfiles perimétricos, Äußere Profile.

3 **Raccordi**, connecting elements, jonctions, enlacs, Verbindungselemente.

4 **Basi**, bases, bases, bases, Basis.

5 **Rivestimento superiore**, top covering, revêtement supérieur, revestimiento superior, Dachbespannung.

6 **Rivestimento laterale**, side covering, revêtement latéral, revestimiento lateral, Seitenbespannung.

1 Montanti

2 Profili perimetrali

3 Raccordi

4 Basi

I montanti e i profili perimetrali che formano le strutture di Resort sono realizzati con un estruso di alluminio e sono assemblati fra loro con raccordi sagomati in acciaio inox. Sono sottoposti a una speciale verniciatura che li rende adatti all'uso anche in condizioni ambientali difficili.

Le strutture poggiano a terra su basi in ghisa stampata dotate di piedini regolabili.

Le basi sono predisposte anche per essere fissate in modo permanente su superfici portanti, come solette, plinti o cordoli in cemento che garantiscano un'adeguata resistenza al peso; in questo caso, il rivestimento in tessuto resiste a carichi di vento fino a un massimo di 35 km/h.

5 Rivestimento superiore

6 Rivestimento laterale

I teli di rivestimento possono essere realizzati in tela bianca di poliestere o in Madras e Tamil, tessuti esclusivi Paola Lenti. Sono permeabili se destinati a strutture con copertura orizzontale; sono impermeabili se montati su strutture inclinate. In entrambi i casi, sono agganciati alla struttura con un sistema che permette lo sganciamento veloce in caso di necessità. I teli rimangono sempre parzialmente ancorati alla struttura grazie a un attacco di sicurezza che ne impedisce il distacco completo.

Le strutture di Resort non sopportano carichi statici accidentali; i teli di rivestimento devono essere smontati in caso di neve o grandine e nei periodi di non utilizzo.

Verniciature e tessuti sono disponibili in colori coordinati.

1 Uprights

2 Perimetral profiles

3 Connecting elements

4 Bases

The uprights and the perimetric profiles forming the structures of Resort are made of extruded aluminium and are assembled by means of stainless steel shaped connecting elements. They are treated with a special varnishing that makes them resistant also in difficult environments.

The structures rest on the ground on basis made of moulded cast iron provided with adjustable feet.

The bases are prepared also to be permanently fixed to weight bearing surfaces, such as concrete slabs, footings or curbs, that must guarantee a sufficient bearing capacity; in this case the fabric covering withstands wind loads up to a maximum of 35 km/h.

5 Top covering

6 Side covering

The top covering can be made of white polyester fabric or of Paola Lenti's signature fabrics Madras or Tamil. They are permeable when mounted on structures with flat top; they are waterproof when used on inclined structures. In both cases, they are hooked to the structure with a system allowing for a rapid release when needed. The fabric remain always partially anchored to the structure thanks to a safety connection that prevent from complete detachment.

The Resort structures do not withstand static accidental loads; the fabric covering must be removed in case of snow, hailstorm or over period of not-utilization.

Varnishing and fabrics are available in coordinated colours.

1 Montants

2 Profils périmétriques

3 Jonctions

4 Bases

Les montants et les profils périmétriques qui forment les structures de Resort sont réalisés en aluminium extrudé et sont assemblés entre eux par des jonctions façonnées en acier inox. Ils sont protégés par un vernis spécial qui les rend appropriés à une utilisation dans des environnements difficiles.

Les structures sont posées au sol sur des bases en fonte moulée pourvues de pieds réglables.

Les bases sont préparées aussi pour l'ancrage permanente au sol sur des surfaces fermes telles que des dalles, des plateformes planes, ou des corniches en béton qui assurent une résistance suffisante aux poids; dans ce cas le revêtement en tissu résiste à la charge du vent jusqu'à un maximum de 35 km/h.

5 Revêtement supérieur

6 Revêtement latéral

Les toiles de revêtement sont disponibles soit en polyester blanc, soit en Madras ou Tamil, tissus exclusifs à Paola Lenti. Elles sont perméables quand elles sont destinées à des structures avec couverture horizontale et sont imperméables quand elles sont montées sur des structures inclinées. Dans les deux cas, elles sont accrochées à la structure par un système qui permet un décrochage rapide en cas de nécessité. Les toiles restent toujours partiellement ancrées à la structure par une attache de sécurité qui en empêche le décrochement complet.

Les structures de Resort ne résistent pas aux charges accidentelles; les toiles de revêtement doivent être démontées en cas de neige, grêle ou en périodes de non-utilisation.

Vernis et tissus sont disponibles en coloris coordonnés.

1 Montantes

2 Perfiles perimétricos

3 Enlaces

4 Bases

Los montantes y los perfiles perimétricos que forman las estructuras de Resort son de aluminio extrudido y se montan con enlaces perfilados de acero inoxidable. Se someten a un barnizado especial para adecuarlo a su uso incluso en condiciones ambientales severas.

Las estructuras apoyan en el suelo sobre bases en hierro moldeado con pies regulables.

Las bases están preparadas también para la fijación permanente sobre superficies portantes, como losas, plintos, o guarniciones de cemento que garanticen una resistencia adecuada al peso; en este caso, el revestimiento en tejido, soporta cargas de viento hasta un máximo de 35 km/h.

5 Revestimiento superior

6 Revestimiento lateral

Las lonas de cobertura se pueden realizar en tela blanca de poliéster o en Madras y Tamil, tejidos exclusivos de Paola Lenti. Son permeables si se usan en estructuras con cobertura horizontal; e impermeables si se montan sobre estructuras inclinadas. En ambos casos, las lonas se anclan a la estructura con un sistema que permite el desprendimiento veloz en caso de necesidad. No obstante permanecen parcialmente ancladas mediante una unión de seguridad que impide su desprendimiento completo.

La estructura de Resort no puede soportar cargas accidentales: todas las lonas se deben desenganchar en caso de nieve, granizo o cuando no se utilice.

Barnizados y tejidos están disponibles en colores coordinados.

1 Pfosten

2 Äußere Profile

3 Verbindungselemente

4 Sockel

Die Ständer und die äußeren Profile, die das Gestell von Resort bilden, bestehen aus extrudiertem Aluminium und werden durch geformte Verbindungselemente aus rostfreiem Stahl verbunden. Sie sind mit einer speziellen Lackierung behandelt, die sie auch für den Einsatz unter rauen Umweltbedingungen geeignet macht.

Das Gestell steht auf Sockeln aus Gusseisen, die mit verstellbaren Füßen versehen sind.

Die Basis verfügten außerdem über entsprechende Vorrichtungen, um sie auf ausreichend tragfähigen Untergründen, wie Betonböden, -platten oder -steinen dauerhaft fixieren zu können. In diesem Fall widersteht die Stoffüberdachung Windlasten von bis zum maximal 35 km/h.

5 Dachbespannung

6 Seitenbespannung

Die Bespannungen werden entweder aus weißem Polyesterstoff oder aus Madras und Tamil Stoff hergestellt, beides exklusive Stoffkreationen von Paola Lenti. Auf den horizontal montierten Gestellen sind die Abdeckflächen wasserdurchlässig, auf den schräg montierten Gestellen sind sie wasserdicht. In beiden Fällen werden sie mithilfe eines speziellen Systems in das Gestell eingehakt, das im Notfall ein schnelle Aushaken erlaubt. Die Abdeckstoffe bleiben jedoch dank einer Sicherheitsverriegelung, die ein komplettes Aushängen des Stoffes verhindert, stets mit dem Gestell verbunden.

Das Gestell von Resort hält keinen Verkehrslasten stand. Die Abdeckstoffe müssen bei Schnee, Hagel oder bei längerem Nichtgebrauch ausgehängt werden.

Lackierungen und Stoffe sind in aufeinander abgestimmten Farben erhältlich.

RESORT



La superficie di copertura è disponibile orizzontale o inclinata. Le due tipologie offrono prestazioni differenti e sono state studiate per permettere di installare Resort in situazioni e luoghi dove la diversa intensità e frequenza delle piogge sono fattori determinanti.

The top can be flat or sloping. The two typologies offer different performances and are designed for the installation of Resort also in situations and places where the different intensity and frequency of rainfall are key factors.

La surface de couverture est disponible soit horizontale soit inclinée. Les deux typologies offrent des performances différentes et ont été dessinées pour permettre d'installer Resort dans des situations et des lieux où l'intensité et la fréquence des précipitations sont des facteurs clés.

La superficie de cobertura está disponible horizontal o inclinada. Las dos tipologías ofrecen prestaciones distintas y están diseñadas para instalar Resort en situaciones y lugares donde la diferente intensidad y frecuencia de las lluvias son factores clave.

Die Überdachung ist in horizontaler oder schräg montierter Ausführung erhältlich. Diese zwei Konstruktionstypen bieten verschiedene Einsatzmöglichkeiten und wurden entwickelt, um Resort auch in Situationen und an Orten mit Regenfällen in unterschiedlicher Intensität und Häufigkeit installieren zu können.

RESORT COMPOSITION PROPOSALS

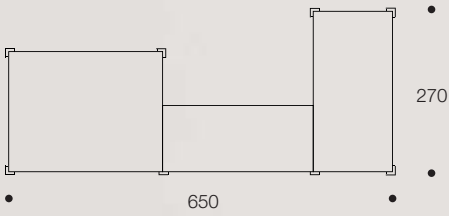

E' possibile articolare i singoli elementi Resort con estensioni che si agganciano alla struttura principale e che prevedono due ulteriori appoggi a terra. Le strutture possono anche essere collegate tra loro con un elemento ponte che le unisce senza necessità di ulteriori appoggi a terra.

It is possible to build articulated structures with single Resort elements and extensions that are joined to the main structure and require two further uprights. The elements can be connected also through a bridge element that joins them without necessity of further uprights.

Il est possible d'articuler les éléments individuels Resort grâce à des extensions qui s'accrochent à la structure principale et qui nécessitent deux supports au sol supplémentaires. Les éléments peuvent être aussi connectés entre eux par un élément-pont qui les unie sans qu'on ait recours à des supports à terre supplémentaires.

Los elementos individuales de Resort se pueden articular con extensiones que se anclan a la estructura principal y que necesiten dos soportes adicionales. Los elementos se pueden unir entre sí por un elemento puente que los une sin necesidad de soportes adicionales.

Es ist möglich, die einzelne Resort Elemente mit Verlängerungen zu erweitern, die am Hauptgestell befestigt werden, und zwei zusätzliche Träger benötigen. Alternativ können die Elemente auch durch ein Brückenelement verbunden werden, wodurch keine weiteren Träger nötig sind.

RESORT COMPOSITION PROPOSALS

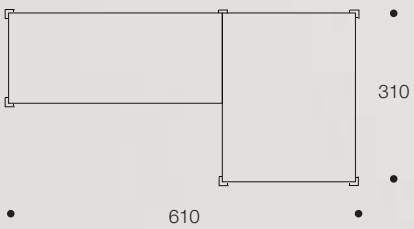











COMPLEMENTS, LIGHTING

OMBRA



CA07B. Materials: aluminium ME416, Thua fabric TH16.

Design: Bestetti Associati

Ombra è un parasole in tessuto. Il suo schermo circolare può essere inclinato e regolato in altezza. La struttura di Ombra è realizzata in alluminio. E' sottoposta a una speciale verniciatura che la rende adatta all'uso anche in condizioni ambientali difficili.

Su superfici portanti, il parasole può essere bloccato a terra con la sola zavorra in cemento, ma per garantire una maggiore stabilità e aumentare la resistenza ai carichi di vento, è consigliato fissarlo al suolo in modo permanente, con tasselli e viti in acciaio, utilizzando sempre anche l'apposita zavorra.

Su superfici non portanti, come prati o spiagge, il parasole deve essere fissato sulla testa di un palo in alluminio annegato nel terreno.

Lo schermo circolare è permeabile ed è composto da due semicerchi. E' realizzato in rete bianca di poliestere o in Thuaia, tessuto esclusivo Paola Lenti. Quando Ombra è chiuso, i semicerchi sono ripiegati uno sull'altro e sono allineati alla struttura verticale di sostegno del parasole. Quando Ombra è aperto, i semicerchi possono formare un'unica superficie piana o essere inclinati indipendentemente l'uno dall'altro per assumere tre differenti posizioni. Le operazioni di apertura e chiusura e le regolazioni sono possibili grazie a uno snodo in acciaio e alluminio.

Verniciature e tessuti sono disponibili in colori coordinati.

Lo schermo non resiste a carichi accidentali. In caso di forte vento o pioggia deve essere richiuso, messo in posizione verticale e agganciato alla struttura di sostegno. Nei periodi di non utilizzo, Ombra va riparato in un ambiente chiuso e protetto.

Ombra is a parasol with a fabric sunshade. Its circular screen can be inclined and adjusted in height. The structure of Ombra is made of aluminium. It is treated with a special varnishing that makes it suitable to resist also in difficult environments.

On weight bearing surfaces, the parasol can firmly stand on the ground with the sole concrete ballast, but in order to ensure greater stability and increase the resistance to wind loads, it is recommended to secure it permanently to the ground, with steel dowels and screws, using always the appropriate ballast.

On non-load-bearing surfaces, such as a lawn or a beach, the parasol must be fixed on the head of an aluminium pole embedded into the ground.

The circular screen is permeable and consists of two semi-circles. It is made either in white polyester net or in Paola Lenti's signature fabric Thuaia. When Ombra is closed, the semi-circles are folded one over the other and aligned to the vertical support structure of the parasol. When Ombra is open, the semi-circles can form a unique flat surface or be inclined independently of one other to assume three different positions. Opening, closing and adjusting operations are possible thanks to an articulated joint made of steel and aluminium.

Varnishing and fabrics are available in coordinated colours.

The screen does not resist to accidental loads. In case of strong wind or heavy rain it must be closed, vertically positioned and fixed to the bearing structure. During non-use periods, Ombra must be sheltered in a closed and protected space.

Ombra est un parasol en tissu. Son écran circulaire peut être incliné et réglé en hauteur. La structure de Ombra est en aluminium. Elle est protégée par un vernis spécial qui permet son utilisation dans des environnements difficiles.

Sur des sols durs, le parasol peut être bloqué au sol avec le seul ballast en béton, mais afin de garantir une stabilité meilleure et augmenter la résistance à la charge du vent, on conseille de le fixer au sol de façon permanente par des chevilles et des vis en acier, tout en utilisant aussi le ballast.

Sur des surfaces meubles, telles qu'une pelouse ou une plage, le parasol doit être fixé sur la tête d'un pieu en aluminium noyé dans le sol.

L'écran circulaire est perméable et formé par deux demi-cercles. Il est réalisé soit en filet blanc polyester soit en Madras ou Tamil, tissus exclusifs à Paola Lenti. Lorsqu'Ombra est fermé, les demi-cercles sont pliés l'un sur l'autre et alignés à la structure verticale de soutien du parasol. Lorsqu'Ombra est ouvert, les demi-cercles peuvent former une seule surface plane ou bien être inclinés de façon indépendante l'un de l'autre, pouvant prendre ainsi trois positions différentes. Les opérations d'ouverture et de fermeture et les réglages sont possibles grâce à une jonction en acier et aluminium.

Vernis et tissus sont disponibles en coloris coordonnés.

L'écran ne résiste pas aux charges accidentelles. En cas de vent fort ou de pluie il doit être fermé, mis en position verticale et accroché à la structure de soutien. Pendant les périodes de non-utilisation, il doit être abrité dans un lieu fermé et protégé.

Ombra es un parasol en tejido. Su sombrilla circular puede inclinarse y regularse en altura. La estructura de Ombra está fabricada en aluminio. Se somete a un barnizado especial para adecuarla a su uso incluso en condiciones ambientales severas.

Sobre superficies portantes, el parasol puede apoyarse simplemente sobre el suelo, utilizando el lastre en cemento, pero para garantizar una estabilidad mayor y aumentar la resistencia a las cargas por viento, se aconseja anclarlo permanentemente al suelo con tacos y tornillos de acero, también utilizando el lastre apropiado.

Sobre superficies no portantes, como prados o playas, el parasol debe ser fijado sobre la cabeza de un polo de aluminio enterrado en el suelo.

La sombrilla circular es permeable y compuesta por dos semicírculos. Se produce en red blanca de poliéster o en Thua, un tejido exclusivo de Paola Lenti. Cuando Ombra está cerrado, los semicírculos se doblan y se alinean con la estructura vertical de soporte del parasol. Cuando Ombra está abierto, los semicírculos pueden formar una única superficie o pueden inclinarse independientemente, en tres posiciones distintas. Apertura, cierre y regulación, se efectúan mediante una pieza de acero y aluminio.

Barnizados y tejidos están disponibles en colores coordinados.

La sombrilla no soporta cargas accidentales. En caso de viento fuerte o lluvia intensa se debe cerrar la sombrilla, ponerla en posición vertical y engancharla a la estructura de soporte. Cuando no se utilice, Ombra se guarda en un espacio cerrado y protegido.

Ombra ist ein Sonnenschirm aus Stoff mit einem runden, schwenkbaren und höhenverstellbaren Schirm. Das Gestell von Ombra besteht aus Aluminium. Es ist mit einer besonderen Lackierung behandelt, die es auch für den Einsatz unter rauen Umweltbedingungen geeignet macht.

Auf tragfähigen Untergründen kann der Sonnenschirm einfach mit seinem Ballast aus Beton aufgestellt werden; dennoch empfehlen wir Ihnen, den Ständer zur Verbesserung der Stabilität und für eine höhere Widerstandsfähigkeit gegen Windlasten zusätzlich mit Dübeln und Schrauben am Boden zu befestigen.

Auf nicht tragfähigen Flächen, wie Rasen und Stränden, muss der Sonnenschirm auf einem in der Erde versenkten großen Erdspeer aus Aluminium befestigt werden.

Der Schirm ist wasserdurchlässig und besteht aus zwei Halbkreisen. Er ist aus weißem Polyesternetz oder aus Thua gefertigt, einem exklusiven Stoff von Paola Lenti. Wenn Ombra geschlossen ist, werden die zwei separat zusammengefalteten Halbkreise aufeinander gelegt und am vertikalen Mast des Sonnenschirms ausgerichtet. Ist Ombra geöffnet, kann mit den Halbkreisen eine einzige ebene Fläche gebildet werden, alternativ lassen sich die Halbkreise auch unabhängig voneinander in drei verschiedene Positionen neigen. Das Öffnen und Schließen sowie die Neigungseinstellungen des Schirms erfolgen über ein Gelenk aus Stahl und Aluminium.

Lackierungen und Stoffe sind in aufeinander abgestimmten Farben erhältlich.

Der Schirm hält keinen Verkehrslasten stand. Bei starkem Wind oder Regen muss er geschlossen, vertikal aufgerichtet und am Gestell verankert werden. Bei längerem Nicht-Gebrauch ist Ombra in einem überdachten, geschützten Raum aufzubewahren.

OMBRA





n°2 CA07B. Materials: aluminium ME002, white polyester net (sunshade open at 45°), Thua fabric TH36 (sunshade closed).









BISTRO'



Bistrò
design: CRS Paola Lenti

Clique
design: Francesco Rota

Bistrò è un parasole in tessuto disponibile piatto o a cupola. Le due versioni sono state studiate per essere usate anche insieme e creare così ampi spazi coperti. La struttura è realizzata in alluminio. È sottoposta a una speciale verniciatura che la rende adatta all'uso anche in condizioni ambientali difficili. Bistrò può essere appoggiato a terra su superfici portanti in cemento, come solette o plinti, utilizzando l'apposita zavorra in ghisa stampata e verniciata. La base è predisposta anche per essere fissata in modo permanente su superfici che garantiscano un'adeguata resistenza al peso.

Su superfici non portanti, come prati o spiagge, il parasole deve essere fissato sulla testa di un palo in alluminio annegato nel terreno. Il telo ombreggiante è fisso o orientabile e poggia su bacchette in fibra di vetro. È permeabile ed è realizzato in Madras o Tamil, tessuti esclusivi Paola Lenti. Uno speciale sistema di apertura e chiusura, nascosto nella struttura portante, permette una grande facilità di utilizzo. Verniciature e tessuti sono disponibili in colori coordinati. Il parasole Bistrò ha vinto il German Design Award 2015 nella categoria Lifestyle e l'Interior Innovation Award 2015, premio istituito dal German Design Council in collaborazione con Imm Cologne.

I tavolini e le sedute Clique (pagina 128) sono accessori che completano e personalizzano i parasole Bistrò e Mogambo, rendendoli piccole aree conviviali riservate dove riposare, pranzare, leggere o conversare. I tavolini di servizio sono disponibili in diverse forme e misure e sono realizzati in alluminio verniciato in colori coordinati alle strutture dei parasole. Possono assumere l'altezza desiderata grazie a uno snodo in materiale plastico posto sotto al piano. Gli elementi di seduta hanno la base in multistrato fenolico e l'imbottitura in poliuretano espanso indeformabile a quote differenziate. Il rivestimento interno in poliestere idrorepellente è fisso; il rivestimento esterno è sfoderabile e disponibile in Rope T o Brio, tessuti esclusivi Paola Lenti.

Bistrò is a parasol made of fabric available with flat or dome-shaped sunshade. The two versions are designed to be used together and to allow this way for the creation of large sheltered areas. The structure is made of aluminium. It is treated with a special varnishing that makes it suitable to resist also in difficult environments. Bistrò can stand free on weight bearing surfaces such as concrete slabs or plinths, using the appropriate ballast made of varnished, moulded cast iron. The base is also suited to be permanently fixed on surfaces which can guarantee an appropriate bearing capacity.

On non-load-bearing surfaces, such as a lawns or a beach, the parasol must be fixed on the head of a aluminium pole embedded into the ground. The sunshade is fixed or can be bent and is supported by glass fibre rods. It is permeable and made of Paola Lenti's signature fabrics Madras and Tamil. A special open-close mechanism, hidden into the bearing structure, makes use very easy. Varnishing and fabrics are available in matching colours.

The Bistrò parasol won the German Design Award 2015 in the category Lifestyle and the Interior Innovation Award 2015, established by the German Design Council in cooperation with Imm Cologne.

The Clique side tables and seating (page 128) are accessories which complete and personalize the Bistrò and Mogambo parasols, creating little reserved convivial areas for resting, eating, reading or talking. The side tables are available in different shapes and sizes and are made of varnished aluminium in colours matching the parasol structure. They can be set at the desired height by means of a threaded ring in plastic materials placed under the top. The seating elements have a base in multilayer phenolic wood and padding in stress resistant, differentiated polyurethane foam. The padding covering in water repellent polyester is non removable; the upholstery cover is removable and available in Paola Lenti's signature fabrics Rope T and Brio.

Bistrò est un parasol en tissu disponible en forme plate ou en coupole. Les deux versions ont été conçues pour être utilisées ensemble et créer ainsi de grands espaces couverts. La structure est en aluminium, elle est protégée par un vernis spécial qui permet son utilisation dans des environnements difficiles. Bistrò peut être posé librement au sol sur des surfaces portantes en béton, telles que des dalles ou des plateformes, en utilisant le ballast en fonte moulée et vernie. La base est préparée aussi pour être fixée de façon permanente sur des surfaces qui assurent une résistance suffisante aux poids.

Sur des surfaces meubles, telles qu'une pelouse ou une plage, le parasol doit être fixé sur la tête d'un pieu en aluminium noyé dans le sol. La toile est fixe ou orientable et soutenue par des baleines en fibre de verre. Elle est perméable et réalisée en Madras ou Tamil, tissus exclusifs à Paola Lenti. Un système spécial d'ouverture et fermeture, caché dans la structure portante, permet une grande facilité d'utilisation. Les vernis et les tissus sont disponibles en coloris coordonnés.

Le parasol Bistrò a gagné le German Design Award 2015 dans la catégorie Lifestyle et l'Interior Innovation Award 2015, prix fondé par le Conseil du Design Allemand en collaboration avec Imm Cologne.

Les tablettes et les assises Clique (page 128) sont des accessoires qui complètent et personnalisent les parasols Bistrò et Mogambo et permettent de créer ainsi de petites zones conviviales où se reposer, manger, lire, converser. Les tablettes sont disponibles en formes et dimensions différentes et sont réalisées en aluminium verni dans des coloris coordonnés aux structures des parasols. Elles peuvent être fixées à la hauteur désirée, grâce à une bague filetée en matériau plastique positionné sous le plan. Les assises ont une base en bois multipliés phénolique et un rembourrage en polyuréthane expansé indéformable de différentes densités. La sous-housse en polyester hydrofuge est fixe; le revêtement est déhoussable et disponible en Rope T et Brio, tissus exclusifs à Paola Lenti.

Bistrò es un parasol en tejido, disponible en forma planas o de cúpula. Las dos versiones han sido diseñadas para su utilización conjunta y crear así grandes áreas cubiertas.

La estructura es de aluminio con un barniz especial para adecuarla a su uso, incluso en condiciones ambientales severas. Bistrò se puede apoyar al suelo sobre superficies portantes en cemento, como losas o plintos, utilizando el lastre en hierro fundido moldeado y barnizado. La base puede también anclarse permanentemente sobre superficies que garanticen una resistencia adecuada al peso.

Sobre superficies no portantes, como prados o playas, el parasol debe ser fijado sobre la cabeza de un polo de aluminio enterrado en el suelo. La sombrilla es fija o orientable y el soporte de la estructura lo componen varillas en fibra de vidrio. Es permeable y se fabrica en Madras

o Tamil, tejidos exclusivos de Paola Lenti. Un sistema especial de apertura y cierre en la estructura portante hacen que su uso sea muy fácil. Barnizados y tejidos están disponibles en colores coordinados.

El parasol Bistrò obtuvo el German Design Award 2015 en la categoría Lifestyle y el Interior Innovation Award 2015, establecido por el German Design Council, en colaboración con Imm Cologne.

Las mesas auxiliares y los asientos Clique (página 128) son accesorios que completan y personalizan los parasoles Bistrò y Mogambo, transformándolos en pequeñas áreas de convivencia y reservados para descansar, comer, leer o conversar.

Las mesas auxiliares están disponibles en distintas formas y dimensiones y son de aluminio barnizado en colores a juego con las estructuras de los parasoles. Se fijan a la altura deseada por medio de una junta en material plástico colocada bajo la mesa. Los elementos de asiento tienen la base en multiestrato fenólico y el relleno en poliuretano expandido diferenciado de alta densidad. Funda fija en poliéster repelente al agua; tapizado desenfundable en Rope T o Brio, tejidos exclusivos de Paola Lenti.

Bistrò ist ein Sonnenschirm aus Stoff, der sowohl mit flachem als auch mit kuppelförmigem Schirm erhältlich ist. Die beiden Versionen können nach Belieben miteinander kombiniert werden, um große Flächen zu überdachen.

Das Gestell besteht aus Aluminium und ist mit einer besonderen Lackierung behandelt, die es auch für den Einsatz unter rauen Bedingungen geeignet macht. Bistrò kann auf tragfähigen Betonflächen, wie z. B. Bodenplatten oder Betonböden, frei aufgestellt werden; allerdings ist dafür der dazugehörige Ballast aus lackiertem Gusseisen zu verwenden. Die Basis ist außerdem entsprechend für die dauerhafte Befestigung auf Untergründen vorbereitet, die einer solchen Belastung standhalten.

Auf nicht tragfähigen Flächen, wie Rasen und Stränden, muss der Sonnenschirm auf einem in der Erde versenkten großen Erdspeer aus Aluminium befestigt werden.

Der Schirm ist fest oder schwenkbar und ruht auf einer Konstruktion aus Glasfaserstangen. Er ist wasserdurchlässig und aus den exklusiven Stoffen Madras oder Tamil von Paola Lenti hergestellt. Ein besonderes, im Gestell verborgenes Öffnungs- und Schließsystem bietet herausragenden Bedienkomfort.

Lacke und Stoffe sind in zusammenpassenden Farben erhältlich.

Der Sonnenschirm Bistrò wurde mit dem German Design Award 2015 in der Kategorie Lifestyle ausgezeichnet und gewann den vom deutschen Rat für Formgebung in Zusammenarbeit mit Imm Cologne begründeten Interior Innovation Award 2015.

Accessoires wie die Clique Beistelltische und Sitzelemente (Seite 128) ergänzen die Bistrò und Mogambo Sonnenschirme und schaffen persönliche, diskrete und komfortable Bereiche zum Erholen, Essen, Lesen oder für gesellige Zusammenkünfte. Die Beistelltische sind in verschiedenen Formen und Größen erhältlich und bestehen aus lackiertem Aluminium in denselben Farben wie das Sonnenschirmgestell. Die Basis der Sitzelemente besteht aus phenolharzbeschichtetem Multiplexholz und ist mit einer Polsterung aus formstabilem Polyurethanschaum in unterschiedlichen Dichten versehen. Der feste Überzug ist aus wasserabstoßendem Polyester; der abnehmbare Bezug ist in den exklusiven Stoffen Rope T oder Brio von Paola Lenti erhältlich.

BISTRÒ, CLIQUE





















MOGAMBO



Design: CRS Paola Lenti

Mogambo è un parasole non richiudibile con rivestimento in corda intrecciata. La struttura è realizzata in alluminio e acciaio. È sottoposta a una speciale verniciatura che la rende adatta all'uso anche in condizioni ambientali difficili.

Mogambo può essere appoggiato a terra su superfici portanti in cemento, come solette o plinti, utilizzando l'apposita zavorra in ghisa stampata e verniciata in colori coordinati. La base è predisposta anche per essere fissata in modo permanente su superfici che garantiscano un'adeguata resistenza al peso.

Lo schermo ombreggiante è permeabile all'aria e all'acqua. È composto da una struttura in acciaio sulla quale è intrecciata a mano una corda mélange in filato Rope. È possibile completare e personalizzare Mogambo con le sedute e i tavolini Clique (pagina128).

In caso di forte vento o nei periodi di non utilizzo è necessario mettere in sicurezza il parasole, non essendo possibile richiudere lo schermo ombreggiante.

Mogambo is a non-folding parasol with sunshade woven by hand. The structure is made of aluminium and steel. It is treated with a special varnish that makes it suitable to resist also in difficult environments.

Mogambo can stand free on weight bearing concrete surfaces, such as slabs or plinths, using the appropriate ballast made of moulded and varnished cast iron in matching colours. The base is also prepared to be permanently fixed on surfaces which can guarantee an appropriate bearing capacity.

The sunshade let air and water pass through. It is made of a cord in melange colours in Rope yarn which is hand woven on a steel frame. Mogambo can be completed and personalised with Clique seating and side tables (page128).

In case of strong wind or in periods of non-use it is necessary to secure the parasol, since it is not possible to fold the sunshade.

Mogambo est un parasol non pliant dont le dais est tressée à la main. La structure est réalisée en aluminium et acier. Elle est protégée par un vernis spécial qui permet son utilisation dans des environnements difficiles. Mogambo peut être posé librement au sol sur des surfaces portantes en béton telles que des dalles ou des plateformes en utilisant le ballast en fonte moulée et vernie. La base est préparée aussi pour être fixée de façon permanente sur des surfaces qui assurent une résistance suffisante aux poids.

Le dais est perméable à l'air et à l'eau. Il est composé d'une structure en acier sur laquelle une corde mélangée en fil Rope est tressée à la main. Mogambo peut être complété et personnalisé avec les poufs et les tablettes Clique (page128).

En cas de vents forts ou pendant les périodes de non-utilisation, il est nécessaire de mettre en sécurité le parasol, puisque le dais ne peut pas être fermé.

Mogambo es un parasol con sombrilla no recellable trenzada a mano. Su estructura es de aluminio y acero barnizado con un acabado especial, para su uso incluso en condiciones ambientales severas.

Se puede apoyar al suelo sobre superficies portantes en cemento, como losas o plintos, utilizando el lastre en hierro fundido moldeado y barnizado. La base puede también anclarse permanentemente sobre superficies que garanticen una resistencia adecuada al peso.

La sombrilla es permeable al aire y al agua. Se compone de una estructura de acero sobre la que se trenza a la mano un cordón Rope bicolor. Puede completarse y personalizarse con los asientos y las mesas auxiliares Clique (página 128).

En caso de viento fuerte o cuando no se utilice, es necesario asegurar toda la estructura, ya que no se puede cerrar.

Mogambo ist ein nicht faltbarer Sonnenschirm mit einer Bespannung aus handgewobenem Seil. Das Gestell besteht aus Aluminium und Stahl. Es ist mit einer besonderen Lackierung versehen, die es auch für den Einsatz in rauen Umgebungen geeignet macht.

Mogambo kann auf tragfähigen Betonflächen, wie z. B. Betonböden oder -Platten, frei aufgestellt werden; allerdings ist zu diesem Zweck der dazugehörige Ballast aus in den dazu passenden Farben lackiertem Gusseisen zu verwenden. Die Basis ist außerdem entsprechend für die dauerhafte Befestigung auf Untergründen vorbereitet, die einer solchen Belastung standhalten.

Der Schirm ist luft- und wasserdurchlässig. Sein Gerüst besteht aus einem Stahlrahmen, auf dem ein mischfarbiges Seil aus Rope Garn von Hand eingewoben wird. Mogambo kann mit Clique Sitzelementen und Beistelltischen ergänzt und nach Belieben persönlich gestaltet werden (Seite 128).

Bei starkem Wind oder längerem Nichtgebrauch ist das ganze Gestell sicher unterzubringen, da der Schirm nicht gefaltet werden kann.







ABRI



Design: Francesco Rota

La serie Abri è composta da pannelli lineari e angolari, studiati per creare spazi riservati e protetti in giardini, spiagge, terrazzi e a bordo piscina.

La struttura di Abri è disponibile in due altezze ed è realizzata in alluminio. È sottoposta a una speciale verniciatura che la rende adatta all'uso anche in condizioni ambientali difficili. I pannelli angolari possono essere usati singolarmente o in composizione con altri pannelli; gli elementi utilizzati per le composizioni sono collegati fra loro con giunti e viti in acciaio.

Il rivestimento permeabile dei pannelli scherma e protegge lasciando filtrare aria e luce. È realizzato in Thua, tessuto esclusivo Paola Lenti. I pannelli Abri possono poggiare a terra su piastre in acciaio o essere fissati al suolo in modo permanente: su superfici portanti, come solette, plinti o cordoli in cemento, le strutture devono essere ancorate a supporti in acciaio verniciato; su superfici non portanti, come prati o spiagge, le strutture devono essere fissate sulla testa di pali in alluminio annegati nel terreno.

Le verniciature sono disponibili in colori coordinati al tessuto di rivestimento.

In caso di forte vento, i pannelli Abri vanno rimossi e messi al riparo in un ambiente chiuso e protetto.

The series Abri is composed of linear and corner panels, conceived to create intimate and sheltered spaces in the garden, on the terrace or beachfront and by the swimming pool. Abri structure is available with two heights and it is made of aluminium. It is treated with a special varnishing that makes it suitable to resist also in difficult environments.

The corner panels can be used alone or in composition with other panels; the elements used in the compositions are joined together by means of joints and steel screws.

The permeable panel covering shields and protect letting air and light pass through. It is made of Thua, a Paola Lenti's signature fabric. Abri panels can stand free on steel plates or be permanently fixed to the ground: on weight bearing surfaces, such as concrete slabs, footings or curbs, the structures must be anchored to varnished steel supports; on non-weight bearing ground, such as a lawn or a beach, the structures must be fixed on the head of aluminium poles embedded into the ground.

Varnishing is available in colours matching the covering fabric.

In case of strong wind, the Abri panels must be removed and sheltered in a closed and protected space.

La série Abri est composée de panneaux droits et d'angle, conçus pour créer des espaces privatifs et protégés dans un jardin, sur une plage, une terrasse ou au bord d'une piscine.

La structure de Abri est disponible en deux hauteurs et est réalisée en aluminium. Elle est protégée par un vernis spécial qui permet son utilisation dans des environnements difficiles.

Les panneaux d'angle peuvent être utilisés seuls ou en composition avec d'autres panneaux; les éléments utilisés dans les compositions sont assemblés entre eux par des joints et des vis en acier. Le revêtement perméable des panneaux cache et protège tout en laissant passer l'air et la lumière. Il est réalisé en Thua, un tissu exclusif à Paola Lenti. Les panneaux Abri peuvent être appuyés au sol sur des platines en acier ou bien être fixés dans le sol de façon permanente: sur des surfaces fermes telles que des dalles, des plateformes ou des corniches en béton, les structures doivent être ancrées dans des supports en acier verni; sur des

surfaces meubles telles qu'une pelouse ou une plage, les structures doivent être fixées sur la tête de pieux en aluminium noyés dans le sol.

Les vernis sont disponibles dans des coloris coordonnés aux tissus de revêtement.

En cas de vents forts, il faut démonter les panneaux Abri et les stocker dans un espace fermé et protégé.

La serie Abri se compone de paneles lineales y de esquina, pensados para crear espacios discretos y protegidos en el jardín, la playa o la piscina.

Su estructura es de aluminio y está disponible en dos alturas distintas. Se somete a un barnizado especial para adecuarla a su uso incluso en condiciones ambientales severas.

Los paneles de esquina se pueden usar solos o en composición con otros paneles; los elementos se unen entre sí con juntas y tornillos de acero.

El tapizado estructural permeable abriga y protege filtrando el aire y la luz. Está realizado en Thua, un tejido exclusivo de Paola Lenti. Los paneles Abri pueden apoyarse sobre el suelo con pletinas de acero o anclarse permanentemente: sobre superficies portantes, como losas, plintos, o guarniciones de cemento, se anclan sobre soportes de acero barnizado; sobre superficies no portantes, como prados y playas, las estructuras se fijan sobre la cabeza de unos polos de aluminio enterrados en el suelo.

El barnizado está disponible en color coordinado con el tejido para tapizar.

En caso de viento fuerte, es necesario quitar los paneles Abri y guardarlos en un ambiente cerrado y protegido.

Die Abri Serie besteht aus geraden Paneelen und Eckpaneelen, die speziell entworfen wurden, um private und geschützte Räume im Garten, am Strand, auf der Terrasse und beim Pool zu schaffen.

Das Gestell von Abri besteht aus Aluminium und ist in zwei Höhen erhältlich. Es ist mit einer besonderen Lackierung behandelt, die es auch für den Einsatz in rauen Umgebungen geeignet macht. Die Eckpaneele können alleine oder in Kombination mit anderen Paneelen verwendet werden; miteinander kombinierte Elemente sind durch Stahlkupplungen und -Schrauben miteinander verbunden.

Der wasserdurchlässige Bezug der Paneele schützt und schirmt zwar ab, lässt jedoch gleichzeitig Luft und Licht durch. Der Bezug ist aus Thua gefertigt, einem exklusiven Stoff von Paola Lenti.

Die Abri Paneele können freistehend auf Stahlplatten aufgestellt oder fest im Boden verankert werden: auf tragfähigen Flächen, wie Betonböden, Bodenplatten oder Betonsteinen, wird die Konstruktion auf lackierten Stahlstützen verankert; auf nichttragenden Flächen, wie Rasen und Stränden, muss sie auf den Köpfen von im Boden versenkten Erdspeießen aus Aluminium befestigt werden.

Die Lacke sind in auf dem Bezugstoff abgestimmten Farben erhältlich.

Bei starkem Wind müssen die Abri Paneele abgebaut und in einem geschlossenen Raum aufbewahrt werden.

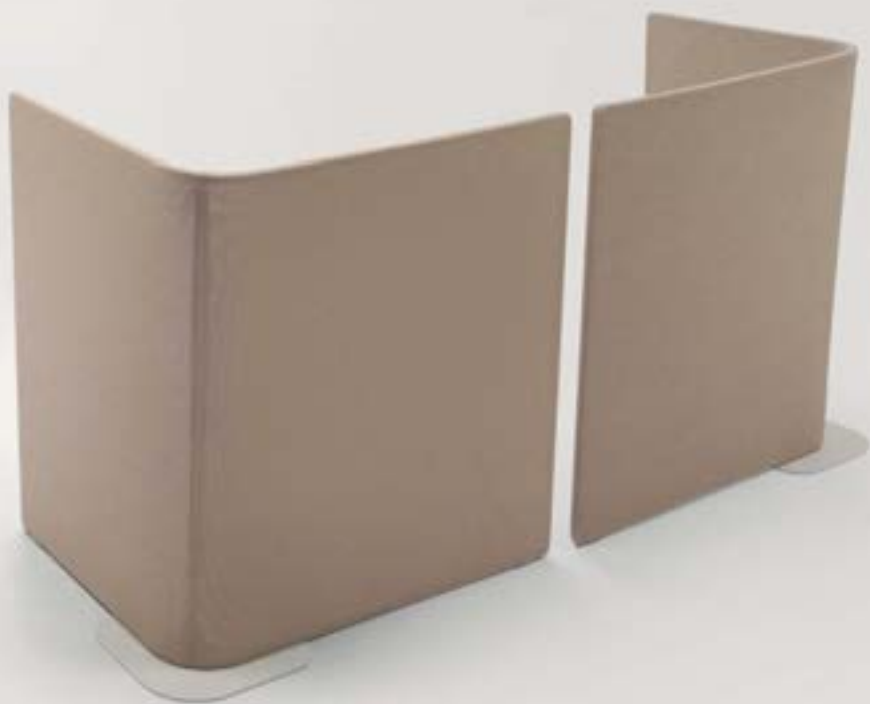

ABRI

















PLANO



Design: Francesco Rota

Plano è una libreria per esterno disponibile con due o quattro ripiani. La collezione comprende anche un tavolino di servizio e una serie di tavoli da pranzo (pagine 250 e 286 Aqua Collection technical book). La struttura delle librerie Plano è realizzata in acciaio. È sottoposta a un trattamento di cataforesi e a una speciale verniciatura che la rende adatta all'uso anche in condizioni ambientali difficili. I ripiani sono in cemento alleggerito in colori coordinati alla struttura o in legno Accoya®. Il cemento alleggerito resiste alla compressione, alla flessione e all'abrasione. I piani realizzati con questo materiale sono quasi del tutto impermeabili. Il legno Accoya® deriva dal legno di pino e proviene da foreste gestite secondo criteri di eco-sostenibilità. I trattamenti ai quali è sottoposto ne aumentano la stabilità dimensionale e la durata, pur permettendone la normale maturazione.

Plano is a bookshelf for the exteriors available with two or four shelves. The collection includes also a side table and a series of dining tables (pages 250 and 286 Aqua Collection Technical Book). The structure of the Plano bookshelves is made of steel. It is treated with cataphoresis and a special varnishing that make it suitable to resist also in difficult environments. The shelves are made of lightened concrete in colours matching the structure or in Accoya® wood. Lightened concrete is resistant to compression, bending and abrasion. The shelves made of this materials are almost completely water repellent. Accoya® wood derives from sustainably sourced pinewood. The treatments applied increase its dimensional stability and durability, yet allowing for its natural aging.

Plano est une étagère pour l'extérieur disponible avec deux ou quatre tablettes. La collection comprend aussi une table basse et une série de tables hautes (pages 250 et 286 Aqua Collection Technical Book). La structure des étagères Plano est réalisée en acier. Elle est traitée par cataphorèse et par un vernis spécial qui permet son utilisation dans des environnements difficiles. Les plans sont en béton allégé en coloris coordonnés à la structure ou en bois Accoya®. Le béton allégé est résistant en compression, en flexion et à l'abrasion. Les plans réalisés avec ce matériau sont presque complètement imperméables. Le bois Accoya® dérive du bois de pin provenant de forêts renouvelables. Les traitements appliqués au bois augmentent sa stabilité dimensionnelle et sa durabilité, tout en permettant son vieillissement naturel.

Plano es una librería para exterior disponible con dos o cuatro baldas. La colección incluye también una mesa auxiliar y una serie de mesas de comedor (páginas 250 y 286 Aqua Collection Technical Book). Los materiales y los acabados ofrecen una alta resistencia a la intemperie. La estructura de las librerías Plano es de acero. Se somete a un tratamiento con cataforesis y a un barnizado especial para adecuarla a su uso incluso en condiciones ambientales severas. Las baldas en cemento aligerado están disponibles en color combinado con la estructura, o en madera de Accoya®. El cemento aligerado es resistente a la compresión, a la flexión y a la abrasión. Las baldas realizadas en este material son casi completamente impermeables. La madera de Accoya® se fabrica con madera de pino procedente de bosques sostenibles. Los tratamientos aplicados aumentan su estabilidad dimensional y durabilidad, permitiendo al mismo tiempo su maduración normal.

Plano ist ein Bücherregal mit zwei oder vier Zwischenböden für den Außenbereich. Die Kollektion umfasst auch einen Beistelltisch und eine Serie von Esstischen (Seiten 250 und 286 Aqua Collection Technical Book). Das Gestell der Plano Bücherregale besteht aus Stahl, der mit cataphoresis und einer Speziallackierung behandelt wurde, die es auch für den Einsatz unter rauen Umweltbedingungen geeignet machten. Die Zwischenböden bestehen aus farblich auf das Gestell abgestimmtem Leichtbeton oder aus Accoya® Holz. Der Leichtbeton widersteht Druck, Biegung und Abrieb. Zwischenböden aus diesem Material sind nahezu vollständig wasserundurchlässig. Accoya® ist Kiefernholz, das aus ökologisch nachhaltig beforsteten Wäldern stammt. Es wird mit Stoffen behandelt, die seine Formbeständigkeit und Haltbarkeit erhöhen, gleichzeitig aber eine normale Holzalterung gestatten.

PLANO









GREENERY



Design: CRS Paola Lenti con Verde Profilo

La serie Greenery è composta da pareti vegetali verticali, studiate per dividere gli spazi all'aperto. Le pareti sono autoportanti e possono essere utilizzate per realizzare aree verdi anche su balconi e terrazzi, dove spesso per le piante non è disponibile uno spazio adeguato. La cornice portante di Greenery è realizzata in acciaio ed è disponibile in due altezze. È sottoposta a una speciale verniciatura che la rende adatta all'uso anche in condizioni ambientali difficili. La cornice accoglie sei file di vaschette in materiale plastico stampato nelle quali possono essere coltivate piante da giardino o da orto. Le vaschette garantiscono isolamento e protezione alle radici e forniscono un ottimo ambiente di crescita.

Le piante preferite possono essere messe a dimora su entrambi i lati oppure su un lato solo, nel caso Greenery vada posizionato in prossimità di una parete già esistente. Un sistema di irrigazione interno permette il mantenimento necessario alla vita delle piante utilizzate. Il sistema va collegato a una rete idraulica fissa.

Greenery può essere appoggiato a terra o fissato in modo permanente con tasselli e viti in acciaio su superfici portanti, come solette, plinti o cordoli in cemento.

The series Greenery consists of green walls, conceived to divide outdoor spaces. These self-bearing walls can be used to create green areas also on balconies and terraces, where sufficient space for plants is often unavailable. The weight bearing frame of Greenery is made of steel and is available in two heights. It is treated with a special varnishing that makes it suited to resist also in difficult environments.

The frame contains six rows of planters made of moulded plastic material where both garden plants and vegetables can be grown. The planters guarantee insulation and protection to the roots and offer an excellent growth environment. The chosen plants can be planted on both sides or on one side only, when Greenery is placed next to an already existing wall. An integrated watering system allow for the maintenance necessary to the life of the plants used. The system must be connected to the main hydraulic network.

Greenery may simply stand on the ground or be permanently fixed with steel dowels and screws on weight bearing surfaces, such as concrete slabs, footings or curbs.

La série Greenery est composée de containers à végétaux qui peuvent servir à diviser les espaces extérieurs. Ils sont autoportants et peuvent être utilisés pour réaliser des zones vertes notamment sur les balcons et les terrasses où souvent il n'y a pas d'espace suffisant pour les plantes. Le cadre portant de Greenery, réalisé en acier, est disponible en deux hauteurs. Il est protégé par un vernis spécial qui permet son utilisation dans des environnements difficiles.

Le cadre contient six rangées de pots rectangulaires moulés en matériau plastique dans lesquels on peut cultiver aussi bien des fleurs que des légumes ou des herbes aromatiques. Les pots assurent l'isolation et la protection des racines et offrent d'excellentes conditions de croissance. Les végétaux choisis peuvent être plantés sur les deux côtés ou sur un seul côté: simple face, Greenery peut-être positionné contre un mur; double-face, il peut servir de séparation. Greenery est équipé d'un système d'irrigation interne qui doit être branché à une arrivée d'eau fixe. Les containers peuvent être posés au sol ou fixés de façon permanente sur des surfaces portantes, telles qu'une dalle, une plateforme, ou une corniche en béton, avec des chevilles et des vis en acier.

La serie Greenery se compone de paredes verticales con plantas para dividir espacios exteriores. Las paredes son auto portantes y se utilizan también en balcones y terrazas, donde frecuentemente no hay espacio adecuado para las plantas.

El marco portante de Greenery es de acero con un barniz especial para su uso en exterior, incluso en condiciones ambientales severas y está disponible en dos alturas. El marco incluye seis filas de contenedores en material plástico moldeado en los que se pueden cultivar plantas de jardín y de huerta. Los contenedores ofrecen aislamiento y protección a las raíces y son un excelente ambiente para el crecimiento de las plantas.

Las plantas elegidas pueden plantarse en ambos lados o sólo en un lado, si Greenery se coloca contra una pared. Mantenimiento por medio de un sistema de drenaje interno. Hay que conectarlo a una pared hidráulica fija. Greenery puede apoyarse sobre el suelo o fijarse permanentemente sobre superficies portantes, como losas, plintos, o guarniciones de cemento, con tacos y tornillos de acero.

Die Serie Greenery besteht aus vertikalen begrünten Wänden, die Räume im Freien unterteilen. Die Wände sind selbsttragend und eignen sich unter anderem perfekt, um grüne Zonen auf Balkonen und Terrassen zu schaffen, wo häufig nicht genügend Platz für andere Pflanzen ist. Der Rahmen von Greenery besteht aus Stahl und ist in zwei Höhen erhältlich. Er ist mit einer besonderen Lackierung versehen, die ihn auch für den Einsatz in rauen Umgebungen geeignet macht.

Der Rahmen enthält sechs Reihen mit Behältern aus geformtem Kunststoff, in die Blumen oder auch Gemüse angepflanzt werden können. Die Behälter bieten den Wurzeln Isolation und Schutz und schaffen so ein hervorragendes Klima für das Pflanzenwachstum.

Die Lieblingspflanzen können wahlweise auf beiden Seiten oder nur auf einer Seite angepflanzt werden, wenn Greenery an einer bereits vorhandenen Wand aufgestellt wird.

Ein eingebautes Bewässerungssystem gewährleistet die kontinuierliche Versorgung der Pflanzen mit Wasser. Das System muss an die Wasserversorgung angeschlossen werden. Greenery kann freistehend oder fest mit Stahlschrauben und -dübeln auf tragenden Flächen wie Betonböden, -platten oder -steinen befestigt werden.



GREENERY













SHIELD, BENCH



Design: Bestetti Associati

Shield è un coprivaso di grandi dimensioni per piante da giardino, disponibile in forme e misure diverse. Il coprivaso permette di non togliere le piante dal loro contenitore originale, che una volta rivestito assume anche una funzione estetica.

Shield può essere utilizzato dove non è disponibile un terreno adeguato per mettere a dimora le piante.

La struttura è realizzata in acciaio inox ed è sottoposta a una speciale verniciatura che la rende adatta all'uso in condizioni ambientali difficili.

Le due metà in cui è diviso Shield si agganciano attorno al vaso da rivestire con un sistema in acciaio inox che rende semplici le operazioni di montaggio e smontaggio.

Una volta assemblato il coprivaso, è necessario riempire la parte superiore con materiali permeabili, come terra, sabbia, corteccia o sassi, per completare l'estetica della composizione e creare un piccolo ambiente coerente con la pianta utilizzata.

Bench (pagina 180) è una fioriera rettangolare o quadrata. È formata da due parti: una tecnica e funzionale interna, destinata a contenere il terriccio, e una estetica di finitura esterna. La struttura, simile per materiale e finiture a quella di Shield, è dotata di puntali regolabili in materiale plastico.

Le fioriere Bench hanno dimensioni utili per essere composte con le sedute per esterno della stessa serie (pagina 116 Aqua Collection technical book). Possono essere utilizzate anche indipendentemente per creare aiuole decorative o piccoli orti in aree come balconi e terrazzi dove spesso per le piante non è esiste uno spazio adeguato.

Shield is a large planter cover for garden plants, available in different forms and dimensions. The cover allows for keeping the plants in their original container, that, once covered, also performs an aesthetic function.

Shield can be used where an appropriate ground for planting is not available.

The structure is made of steel and is protected with a special varnishing that makes it suited to resist also in difficult environments.

Shield is divided into two halves that can be hooked around the planter to be covered by means of a stainless steel system that makes assembly and disassembly very easy.

Once the cover is assembled, it is necessary to fill the upper part with permeable materials, such as ground, sand, bark or stones, in order to complete the aesthetics of the composition and create a little space coherent with the used plant.

Bench (page 180) is a rectangular or square planter. It is composed of two parts: an internal one, technical and functional, aimed to contain the soil and an external, esthetically finishing one. The structure, similar to the Shield's one as far as materials and finishes are concerned, is provided with adjustable plastic spacers.

The Bench planters are available in such dimensions that make it possible to combine them with the outdoor seating of the same series (page 116 Aqua Collection Technical Book). They can be used also alone to create beds planted with grass or even vegetables, in such areas like balconies and terraces where, very often, an appropriate space for plants is unavailable.

Shield est une collection de cache-pots de grandes dimensions pour plantes de jardin disponible en différentes formes et dimensions qui permettent de garder les plantes dans leur contenant original qui, une fois caché, effectue également une fonction esthétique.

Shield peut être utilisé là où il n'y a pas de surfaces appropriées pour cultiver les plantes.

La structure, réalisée en acier inox, est protégée par un vernis spécial qui permet son utilisation dans des environnements difficiles.

Elle est conçue en 2 parties qui se fixent autour du pot grâce à un système en acier inox qui simplifie les opérations de montage et démontage.

Après avoir assemblé le cache-pot, il est nécessaire de remplir la partie supérieure avec des matériaux perméables, tels que de la terre, du sable, de l'écorce ou des cailloux, afin de compléter l'esthétique de la composition et créer ainsi un petit milieu cohérent avec la plante utilisée.

Bench (page 180) est une jardinière rectangulaire ou carrée. Elle est formée de deux parties: une, interne, technique et fonctionnelle, destinée à contenir la terre, l'autre, esthétique, de finition externe. La structure, pareil par matériaux et finitions à celle de Shield, est équipée d'écarteurs réglables en matériau plastique.

Les jardinières Bench ont les dimensions appropriées pour être combinées avec les sièges pour l'extérieur de la même série (page 116 Aqua Collection Technical Book). Elles peuvent être aussi utilisées seules pour créer des parterres décoratifs plantés avec de l'herbe ou même des légumes dans des espaces, tels qu'un balcon ou une terrasse, là où souvent il n'y a pas d'espace suffisant pour les plantes.

Shield es una cubierta para macetas de grandes dimensiones disponible en distintos tamaños y formas. La cubierta permite guardar las plantas en su contenedor original, que, una vez revestido, también realiza una función estética.

Shield puede utilizarse donde no hay un terreno adecuado para plantar.

La estructura se produce en acero inox y se somete a un barnizado especial para adecuarlo a su uso, incluso en condiciones ambientales severas.

Las dos partes que forman Shield se enganchan en torno a la maceta mediante un sistema en acero inox que simplifica las operaciones de montaje y desmontaje.

Una vez montada la cubierta, es necesario llenar la parte superior con materiales permeables, como tierra, arena, piedras o cortezas, para completar la estética de la composición y crear un pequeño ambiente coherente con la planta utilizada.

Bench (página 180) es una maceta rectangular o cuadrada. Está formada para dos partes: una interna, técnica y funcional, para contener el suelo, y una estética, de acabado exterior. La estructura, en los mismos materiales y acabados de Shield se completa de pies regulables de plástico.

Las macetas Bench tienen dimensiones útiles para componerse con los asientos de la misma serie (pagina 116 Aqua Collection Technical Book). Se pueden utilizar también solas para crear parterres decorativos o incluso verduras, en zonas como balcones y terrazas donde a menudo no hay un espacio adecuado para las plantas.

Shield ist ein großer zweiteiliger Übertopf für Gartenpflanzen, der in verschiedenen Formen und Größen erhältlich ist. Der Übertopf bietet die Möglichkeit, die Pflanzen im ursprünglichen Behälter aufzubewahren: er wird ganz einfach darübergestülpt und verbessert so das ästhetische Erscheinungsbild des Topfes erheblich.

Shield kann eingesetzt werden, wo oft keine geeignete Erde zum Einsetzen von Pflanzen verfügbar ist.

Das Gestell besteht aus rostfreiem Stahl und ist mit einer besonderen Lackierung versehen, die es auch für den Einsatz unter rauen Umweltbedingungen geeignet macht.

Die zwei Hälften, aus denen Shield besteht, lassen sich mithilfe eines Systems aus rostfreiem Stahl um den Pflanzenbehälter einhaken. Dieses System ermöglicht eine einfache Montage und Demontage des Übertopfes.

Nach der Montage muss der obere Teil mit durchlässigen Materialien, wie Erde, Sand, Rinde oder Steinen aufgefüllt werden, um das ästhetische Bild abzurunden und eine zu der eingepflanzten Pflanze passende Umgebung zu schaffen.

Bench (seite 180) ist ein in viereckiger oder rechteckiger Form erhältlicher Blumenkasten. Er besteht aus zwei Teilen: das innenliegende technische und funktionelle Element enthält die für das Leben der Pflanzen benötigte Komposterde, und das äußere Element dient dem ästhetischen Erscheinungsbild. Das Gestell besteht aus denselben Materialien wie Shield und wird ähnlich behandelt, ist aber mit verstellbaren Kunststoffgleitern versehen.

Die Außenmaße der Bench Blumenkästen sind entsprechend auf die Sitzelemente für den Außenbereich derselben Serie abgestimmt (Seite 116 Aqua Collection Technical Book). Sie können jedoch auch alleine verwendet werden, um dekorative Beete oder auch Gemüse auf Balkonen und Terrassen anzulegen, wo ansonsten häufig kein geeigneter Platz für Pflanzen ist.





SHIELD





BENCH



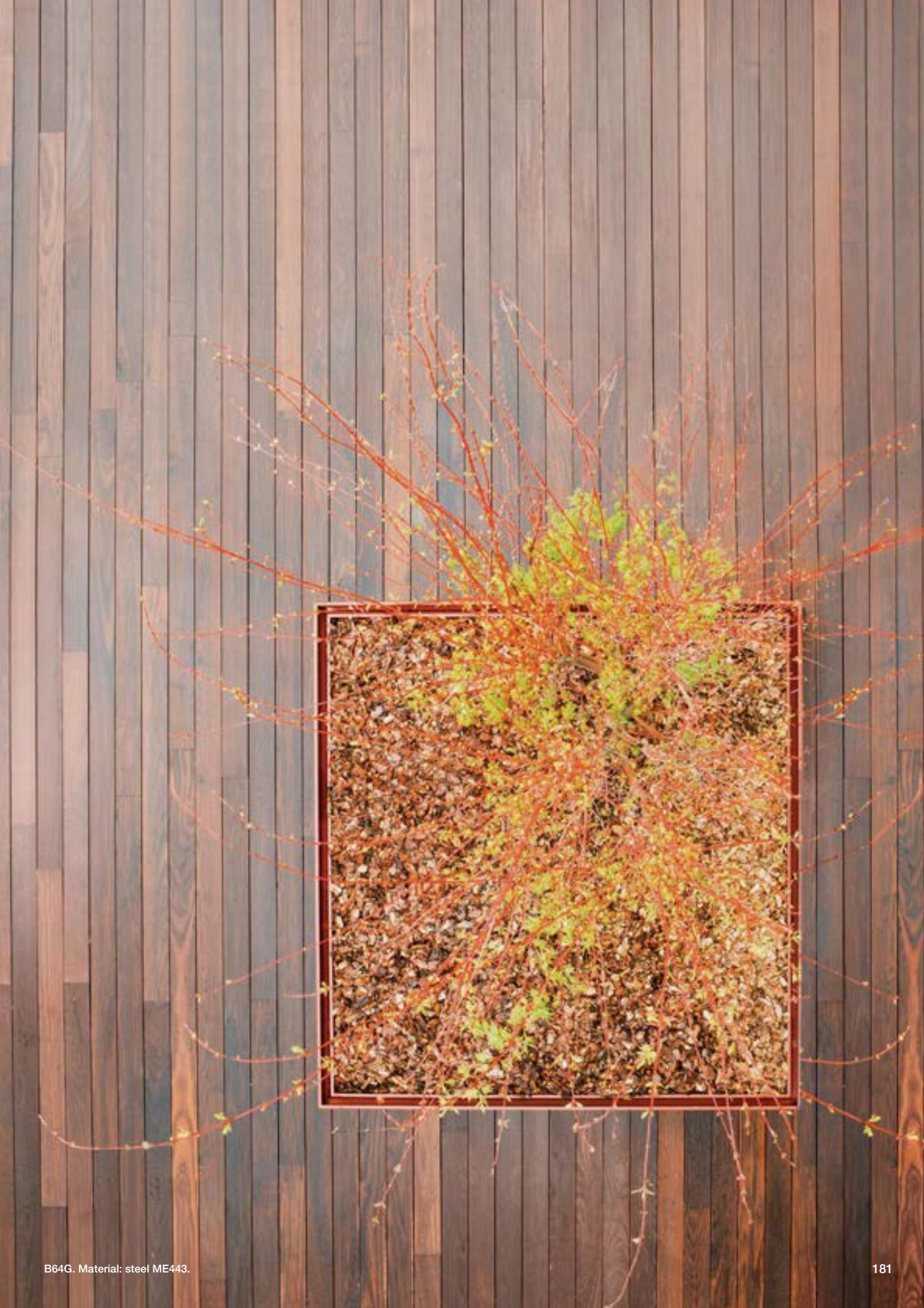





LENTA



CA06A

Design: Davide Groppi, Bestetti Associati

Lenta è una lampada che può essere usata sia a terra sia sospesa. La struttura è in alluminio, il diffusore in metacrilato e policarbonato. Lenta monta una lampadina E27 fluorescente compatta da 11W e rispetta le norme internazionali per il collegamento alla rete in ambienti esterni.

Lenta is a lamp designed for both floor and suspension use. The structure is made of aluminium, the lamp shade of methacrylate and polycarbonate. Lenta uses a fluorescent compact 11W - E27 bulb and complies with the international standards for the connection to the power grid in exterior environments.

Lenta est une lampe qui peut être utilisée soit posée au sol, soit en suspension. La structure est en aluminium, l'abat-jour en méthacrylate et polycarbonate. Lenta est équipée d'une ampoule E27 fluorescente compacte de 11W et elle est conforme aux normes internationales pour la connexion aux réseaux électriques en milieu extérieur.

Lenta es una lámpara que puede utilizarse tanto a suelo como en suspensión a techo. La estructura es en aluminio, la pantalla en metacrilato y policarbonato. Lenta monta una bombilla fluorescente compacta E27 11W y cumple las normas internacionales para su uso en exterior.

Lenta ist eine Lampe, die sowohl als Steh- als auch als Hängeleuchte verwendet werden kann. Das Gestell besteht aus Aluminium, der Lampenschirm ist aus Methacryl und Polycarbonat gefertigt. Lenta benötigt eine E27 Kompaktleuchtstofflampe mit maximal 11W und entspricht den internationalen Standards für den Anschluss an das Stromnetz im Außenbereich.

SHOJI



AC302E, AC303E.

Design: Davide Groppi con CRS Paola Lenti

Le lampade da terra Shoji sono disponibili in due dimensioni, sia nella versione da esterno sia in quella da interno. La base è in acciaio inox verniciato nero con puntali in materiale plastico. Il diffusore è realizzato cucendo a spirale una corda opalina in poliestere. Shoji monta un modulo led da 18W/3000K.

Shoji floor lamps are available in two dimensions, both in the indoor and outdoor version. The base is made of black varnished stainless steel provided with plastic spacers. The lamp shade is made of a semi-transparent polyester cord which is sewn in a spiral-like pattern. Shoji uses an 18W/3000K led module.

Les lampadaires Shoji sont disponibles en deux dimensions et en deux versions, pour l'extérieur et pour l'intérieur. La base est en acier inox verni noir avec des écarteurs en matériau plastique. L'abat-jour est réalisé avec une corde opaline en fil polyester cousue en spirale. Shoji est équipé d'un module LED de 18W/3000K.

Las lámparas de pies Shoji estan disponibles en dos tamaños, tanto en la versión para exterior, como en la para interior. La base es en acero inox lacado negro con patines de plástico. La pantalla se fabrica cosiendo en espiral un cordón en poliéster semitransparente. Shoji monta un módulo led 18W/3000K.

Die Stehleuchte Shoji ist in zwei Größen erhältlich, sowohl in der Version für den Innen- als auch für den Außenbereich. Die Basis besteht aus schwarz lackiertem rostfreiem Stahl und ist mit Kunststoffgleitern versehen. Der Lampenschirm besteht aus einem spiralförmig vernähten, opalartigen Polyesterseil. Shoji benötigt ein 18W/3000K LED-Modul.

TAIKI



Design: CRS Paola Lenti

Serie di lampade a sospensione disponibili in tre dimensioni. Il doppio diffusore è composto da una parte esterna, realizzata cucendo a spirale una corda in filato Rope tinta unita o bicolore, e da una parte interna realizzata con una corda opalina in poliestere cucita con la stessa tecnica. Taiki monta un modulo led a luce diffusa da 10W.

Series of suspension lamps available in three dimensions. The double lamp shade consists of an external part, made of a one or two-colour Rope cord which is sewn in a spiral-like pattern and an internal part made of a semi-transparent polyester cord sewn with the same technique. Taiki uses a diffused light 10W led module.

Série de lampes en suspension disponibles en trois dimensions. Le double abat-jour se compose d'une partie externe réalisée avec une corde en fil Rope de teinte unie ou bicolore cousue en spiral, et d'une partie interne réalisée avec une corde opaline en fil polyester cousue avec la même technique. Taiki est équipé d'un module LED de 10W.

Serie de lámparas de suspensión disponibles en tres tamaños distintos. La doble pantalla se compone de una parte externa, fabricada cosiendo en espiral un cordón en hilo Rope monocolor o bicolor, y de una interna fabricada con un cordón en poliéster cosido con la misma técnica. Taiki monta un módulo LED a luz difusa de 10W.

Eine in drei Größen erhältliche Hängelampen-Serie. Der zweilagige Lampenschirm besteht außen aus einem spiralförmig vernähten ein- oder zweifarbigem Seil aus Rope Garn und innen aus einem opalartigen Polyesterseil, das mit derselben Technik genäht wird. Taiki benötigt ein 10W LED- Streulicht-Modul.





AGADIR



Design: CRS Paola Lenti

Serie di lanterne di forme e dimensioni diverse. Il diffusore è realizzato cucendo a spirale una corda in filato Rope tinta unita o bicolore, intervallando parti piene a parti traforate per permettere alla luce di diffondersi. Il corpo illuminante a luce variabile è a batteria e monta un modulo led da 2,5W/2700K. La batteria è ricaricabile e ha una autonomia di circa 6 ore.

Series of lanterns with different forms and dimensions. The lamp shade is made of a one or two-colour Rope cord sewn in a spiral-like pattern, alternating full and openwork parts to allow for light diffusion. The lighting body with variable light is battery powered and uses a 2,5W/2700K Led module. The battery is rechargeable and lasts about 6 hours.

Série de lanternes de formes et de dimensions différentes. L'abat-jour est réalisé avec une corde en fil Rope de teinte unie ou bicolore cousue en spiral en alternant les parties pleines et les parties avec décor ajouré qui permettent la diffusion de la lumière. L'intensité de la lumière est réglable; la batterie est rechargeable, et dure environ 6 heures. Le luminaire est équipé d'un module LED de 2,5W/2700K.

Serie de linternas en distintos formas y tamaños. La pantalla se fabrica cosiendo en espiral un cordón en hilo Rope monocolor o bicolor, alternando partes llenas y partes caladas que permiten la difusión de la luz. El cuerpo iluminante a luz ajustable es a batería y monta un módulo led 2,5W/2700K. La batería puede recargarse y tiene un alcance de 6 horas aprox.

Eine in verschiedenen Größen und Formen erhältliche Laternen Serie. Der Schirm besteht aus einem ein- oder zweifarbigen Seil aus Rope Garn, das spiralförmig mit einem sich abwechselnden Muster aus vollen und durchbrochenen Verzierungen aufgenäht wird und Licht durchlässt. Die Batteriebeleuchtung mit dimmbarem Licht ist aufladbar, und dauert etwas 6 Stunden. Die Laternen benötigen ein 2,5W/2700K LED-Modul.





TECHNICAL DETAILS

Le fasi di montaggio delle strutture Cabanne, Pavilion, Resort e Ala, dei parasole Bistrò e Om-bra e dei pannelli Abri sono illustrate dettagliatamente nei manuali in dotazione. Prima di qualsiasi operazione, i manuali devono essere letti attentamente per verificare la disponibilità di tutti i mezzi e gli strumenti necessari e l'esistenza di tutti i presupposti che garantiscano una corretta e sicura installazione.

Una volta installato il prodotto, è necessario verificare che il montaggio sia stato eseguito in modo corretto e che tutte le sue fasi siano state rispettate, per prevenire ed evitare qualsiasi problema durante l'uso.

La manutenzione dei materiali e la pulizia dei tessuti devono essere eseguite solo con i prodotti e i metodi consigliati nelle istruzioni fornite dall'azienda; la loro periodicità è strettamente legata alle condizioni d'uso del prodotto. Queste operazioni, necessarie a mantenere le strutture da esterno nelle condizioni migliori, devono essere costanti e accurate; solo così potranno limitare gli inevitabili problemi causati da condizioni climatiche, inquinamento, atmosfere marine ed esposizione prolungata ai raggi UV.

The assembly phases of the structures Cabanne, Pavilion, Resort and Ala, the parasols Bistrò and Ombra and the Abri panels are given in details in the manuals delivered with the products. Before starting assembly, read them carefully to verify the availability of the necessary equipment and tools and the existence of all the conditions necessary to guarantee a correct and safe installation.

Once the product is installed, verify that the assembly has been executed correctly and that all the corresponding phases have been properly carried out, to prevent and avoid any problem when using the product.

Only use the products and the methods recommended by the Company for the maintenance of the materials and the cleaning of the fabrics; their frequency strictly depends on the conditions under which the product is used. These operations are necessary to keep the outdoor structures in the best conditions, therefore, they must be regular and accurate; this is the only way to limit the inevitable problems caused by climate conditions, pollution, marine atmospheres and prolonged exposition to UV rays.

Les phases de montage des structures Cabanne, Pavilion, Resort et Ala, des parasols Bistrò et Ombra et des écrans Abri sont détaillées dans les instructions de montage fournies avec les produits. Avant toute opération, il faut les lire attentivement et vérifier la disponibilité de tous les outils et équipement nécessaires, ainsi que l'existence de toutes les conditions qui garantissent la sécurité d'une installation correcte.

Une fois le produit installé, il faut vérifier que le montage a bien été exécuté correctement et que toutes ses phases ont été respectées, afin de prévenir et d'éviter tout problème lors de l'utilisation.

L'entretien des matériaux et le lavage des tissus ne doivent être exécutés qu'avec les produits et les méthodes conseillés dans les instructions d'emploi fournies par la Maison; la fréquence est strictement liée au conditions d'utilisation du produit. Ces opérations sont nécessaires pour garder les structures utilisées en extérieur dans les meilleures conditions possibles et doivent donc être renouvelées soigneusement et régulièrement; c'est le seul moyen pour limiter les problèmes inévitablement causés par le climat, la pollution, l'atmosphère marine et l'exposition prolongée au rayons UV.

El montaje de las estructuras Cabanne, Pavilion, Resort y Ala, de los parasoles Bistrò, Mogambo y Ombra y de los paneles Abri se explica en detalle en los manuales suministrados con el producto. Antes de cualquier operación, es necesario leerlo cuidadosamente para verificar la disponibilidad de todos los medios e instrumentos necesarios y la existencia de todas las condiciones que garanticen una instalación correcta y segura.

Una vez instalado el producto, es necesario asegurarse que el montaje fue correcto y que se terminaron todas sus fases, para prevenir y evitar cualquier problema durante el uso.

El mantenimiento de los materiales y la limpieza de los tejidos deben hacerse solo con los productos y los métodos indicados en las instrucciones suministrados por Paola Lenti; la frecuencia depende de las condiciones de uso del producto. Estas operaciones son necesarias para mantener las estructuras de exterior en las mejores condiciones y por tanto, deben ser constantes y cuidadosas; sólo así se limitan los inevitables problemas causados por las condiciones climáticas, la contaminación, la cercanía al mar y la exposición prolongada a los rayos UV.

Die Montagephasen der Cabanne, Pavilion, Resort und Ala Konstruktionen, der Sonnenschirme Bistrò und Ombra und der Abri Paneele sind in der mit dem Produkt mitgelieferten Montageanleitung angegeben. Lesen Sie die Anleitung vor der Montage aufmerksam durch und stellen Sie sicher, dass alle nötigen Vorrichtungen und Werkzeuge bereit stehen und dass alle Voraussetzungen für eine richtige und sichere Installation gegeben sind.

Kontrollieren Sie nach der Installation unbedingt, ob die Montage korrekt ausgeführt wurde und ob alle Schritte befolgt wurden, um möglichen Problemen während des Gebrauchs vorzubeugen bzw. solche Probleme von vornherein zu vermeiden.

Die Wartung und Pflege der Materialien und der Stoffe darf nur mit den vom Unternehmen in der Wartungs- und Pflegeanleitung angegebenen Produkten und Verfahren durchgeführt werden; die Wartungs- und Pflegeintervalle sollten entsprechend an die Einsatzbedingungen des Produkts angepasst werden.

Diese Handgriffe, die nötig sind, um den guten Zustand der Konstruktionen in Außenbereichen zu erhalten, sollten daher regelmäßig und sorgfältig durchgeführt werden. Nur so können die durch Witterungseinflüsse, Verschmutzung, Meeresklima und längere Exposition gegenüber UV-Strahlen bedingten unvermeidlichen Probleme wirkungsvoll begrenzt werden.

Cabanne, Modulo Quadro
design Bestetti Associati

CA01A structure without base

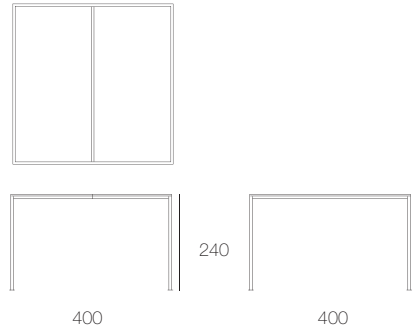

CA01AH structure without base

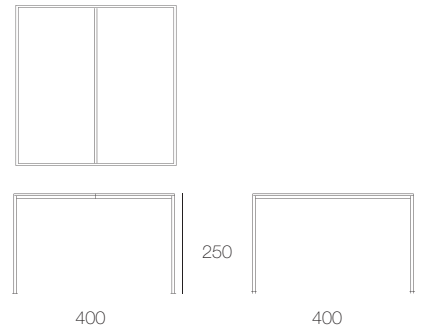

CA01AB structure with base

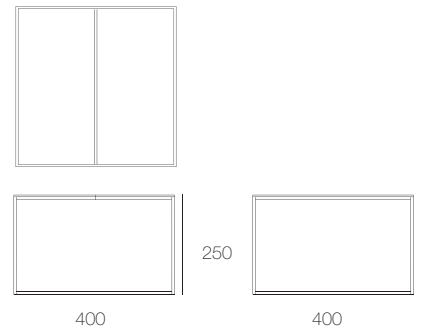

CA01ABH structure with base

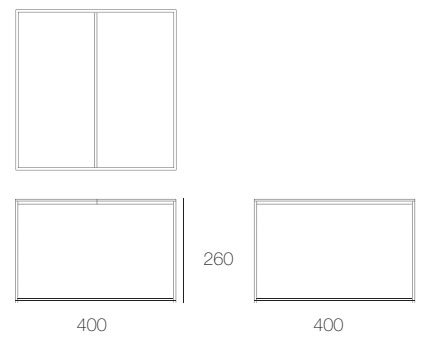

CA01B aluminium top

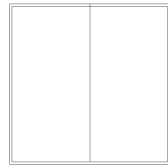

400

CA01C fabric top

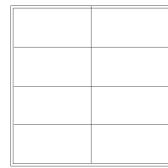

400

CA01D wood lattices top

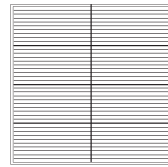

400

CA01S fabric top with false ceiling

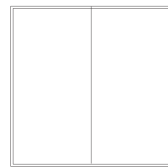

400

CA01R fabric false ceiling

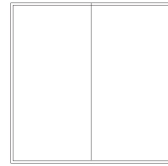

400

CA01H wood lattices fixed panel



217

93

CA01L Thuya fabric fixed panel



217

105

CA01M wood lattices moving panel



217

93

CA01N Thuya fabric moving panel



217

105

CA01P Shade fabric curtain



217

100



217

93

Cabanne, Modulo Tunnel
design Bestetti Associati

CA02A Modulo Tunnel in wood
without base, low uprights

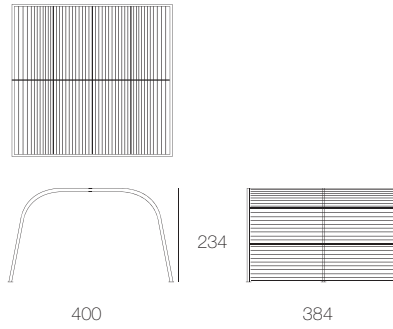

CA02AT Modulo Tunnel in fabric
without base, low uprights

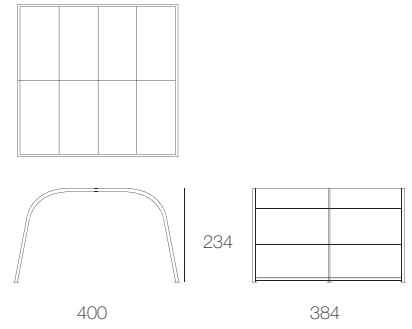

CA02AH Modulo Tunnel in wood
without base, high uprights

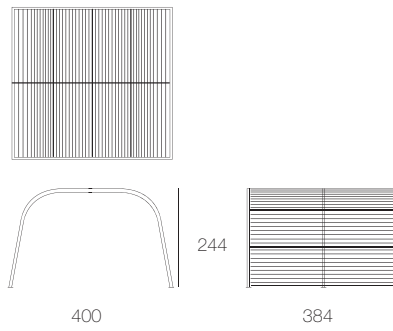

CA02ATH Modulo Tunnel in fabric
without base, high uprights

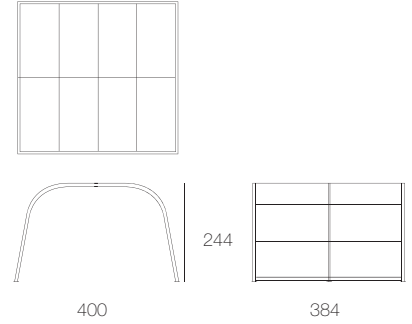

CA02AB Modulo Tunnel in wood
with base, low uprights

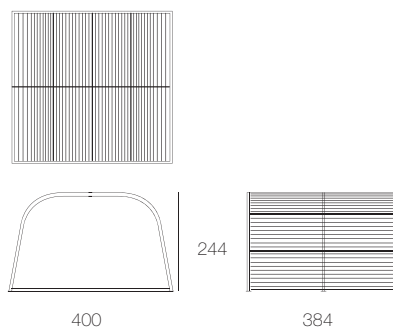

CA02ATB Modulo Tunnel in fabric
with base, low uprights

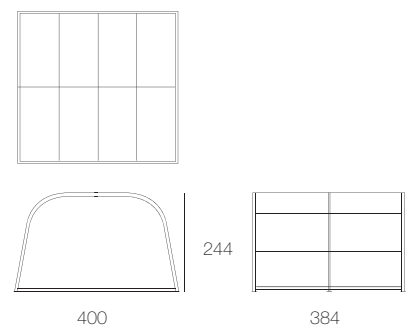

CA02ABH Modulo Tunnel in wood
with base, high uprights

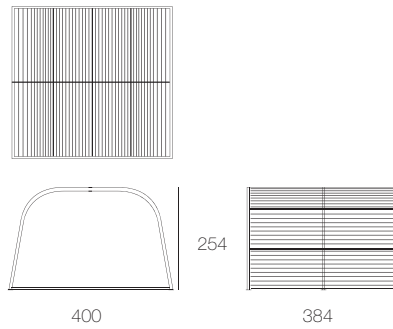

CA02ATBH Modulo Tunnel in fabric
with base, high uprights

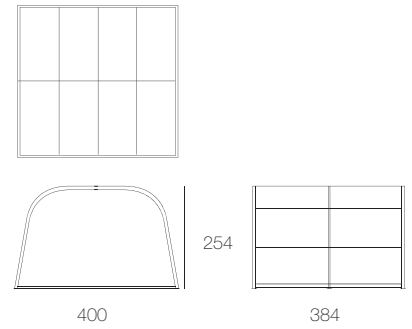

Cabanne, Modulo Veranda
design Bestetti Associati

CA01F Modulo Veranda in wood
without base, low uprights

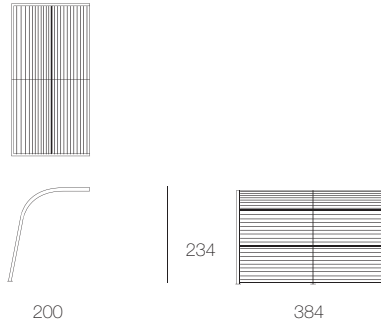

CA01FT Modulo Veranda in fabric
without base, low uprights

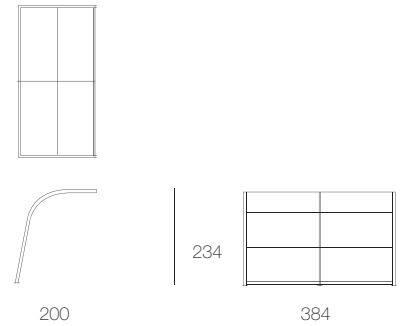

CA01FH Modulo Veranda in wood
without base, high uprights

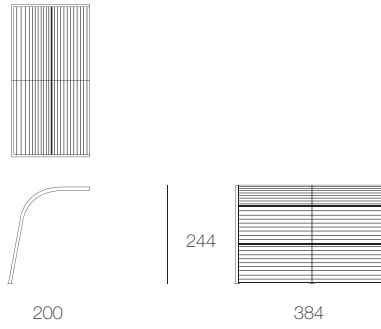

CA01FTH Modulo Veranda in fabric
without base, high uprights

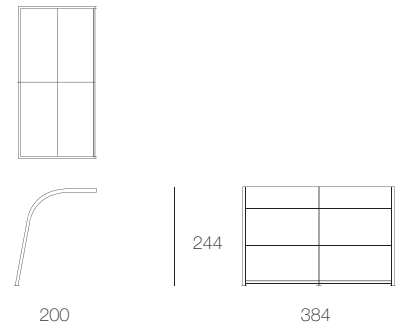

CA01FB Modulo Veranda in wood
with base, low uprights

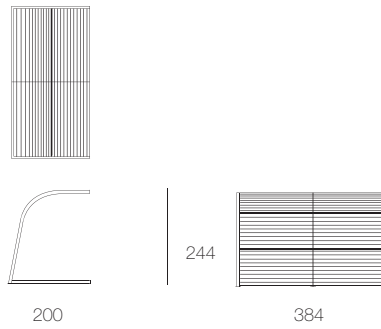

CA01FTB Modulo Veranda in fabric
with base, low uprights

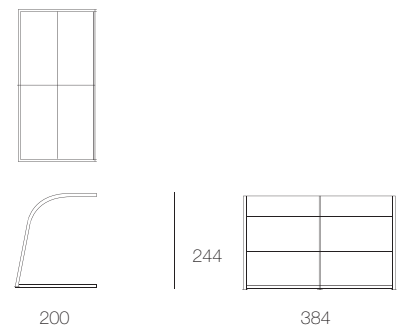

CA01FBH Modulo Veranda in wood
with base, high uprights

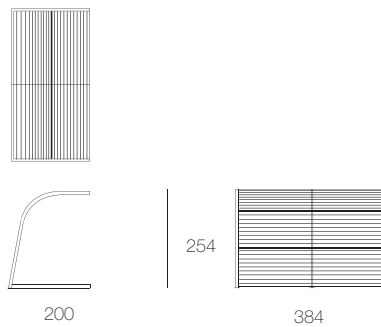

CA01FTBH Modulo Veranda in fabric
with base, high uprights

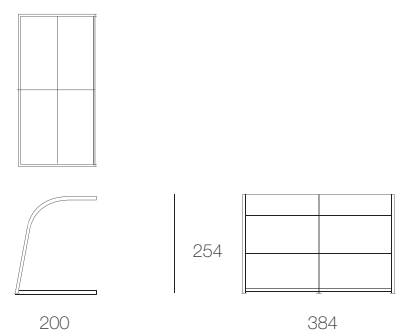

CA05G sliding sail with base
CA05H sliding sail without base

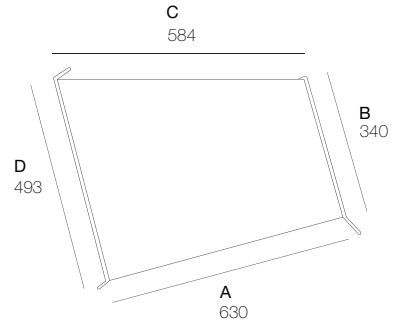

CA05E fixed sail with base
CA05F fixed sail without base

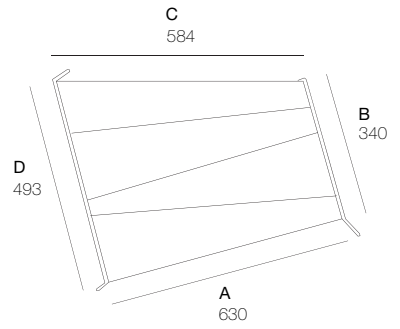

front A

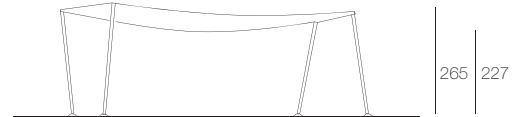

front B

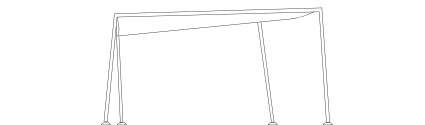

front C



front D

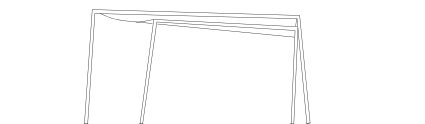

Pavilion
design m-ar by Renato J. Morganti

CA16C single hexagon top

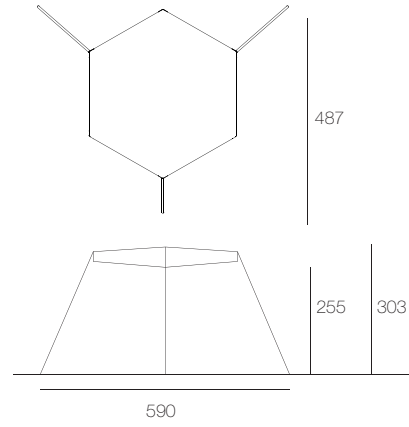

CA16A single hexagon top with 3 supporting panels

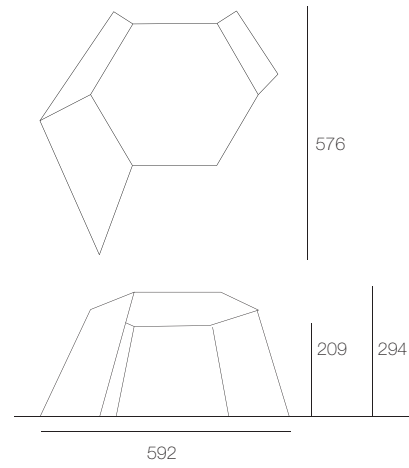

CA16D 2 hexagon tops with 4 supporting panels

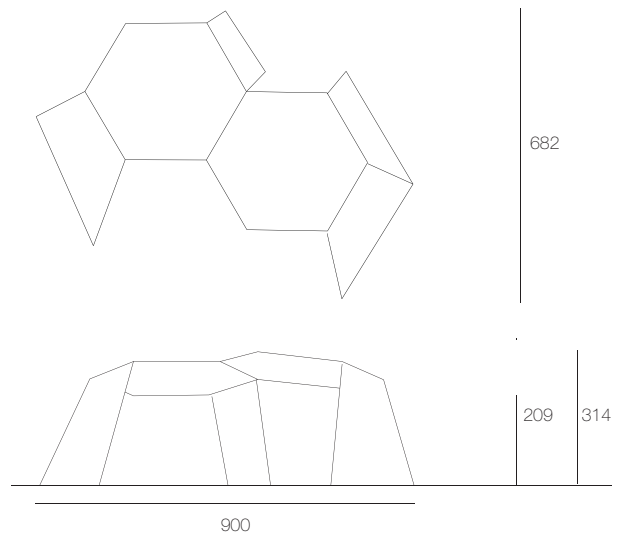

Pavilion
design m-ar by Renato J. Morganti

CA16E 3 hexagon tops with 5 supporting panels

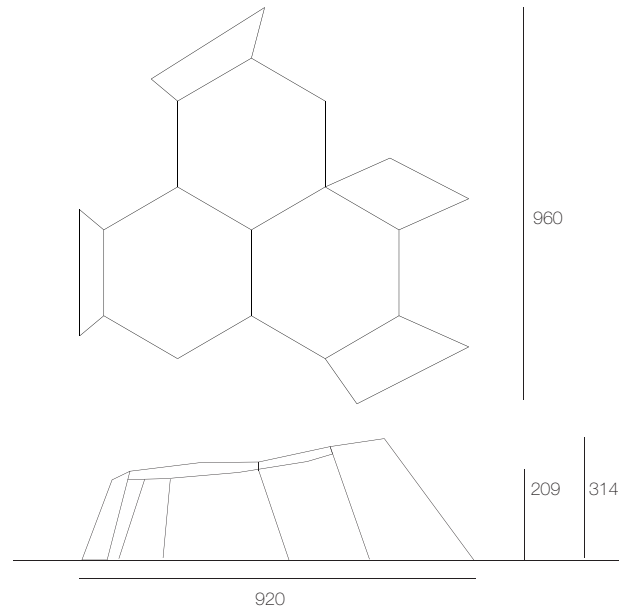

CA16B 3 hexagon tops with 5 supporting panels

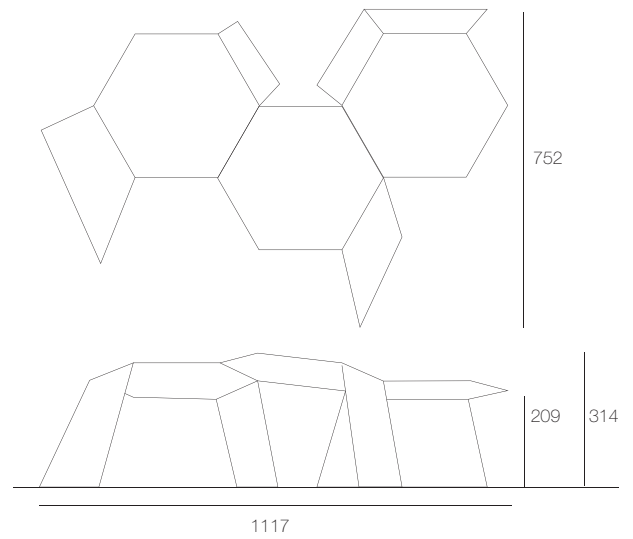

Resort
design Fattorini+Rizzini+Partners

CA17A shading structure

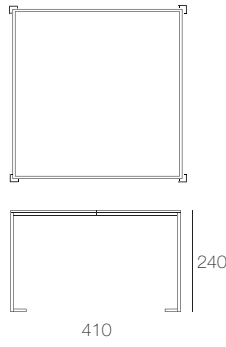

CA17D shading structure

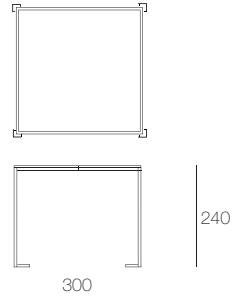

CA17B asymmetric shading structure

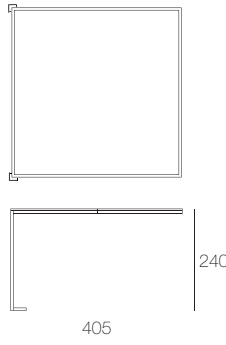

CA17E asymmetric shading structure

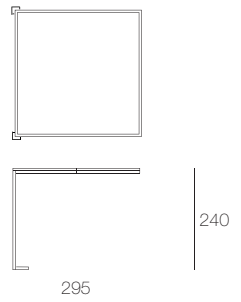

CA17G shading structure

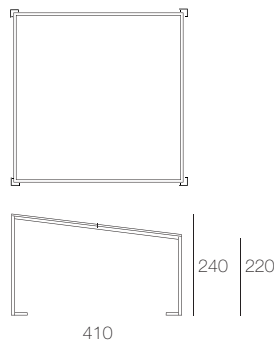

CA17H shading structure

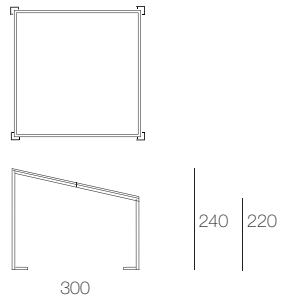

CA17C bridge



CA17F bridge



Ombra
design Bestetti Associati

CA07A parasol

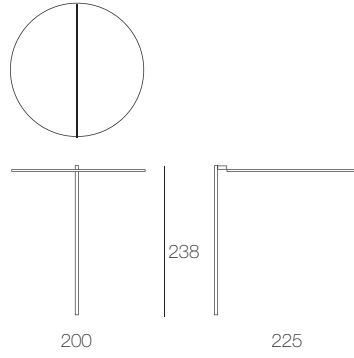

CA07B parasol with base

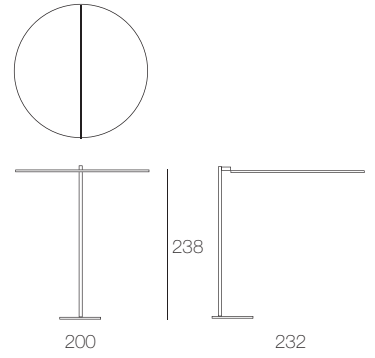

Bistrò
design CRS Paola Lenti

CA09A domed parasol

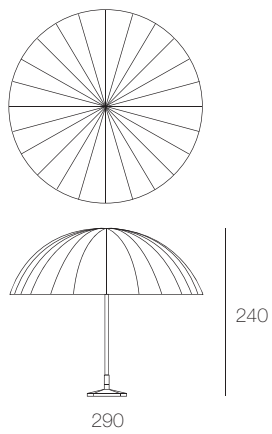

CA09C flat parasol

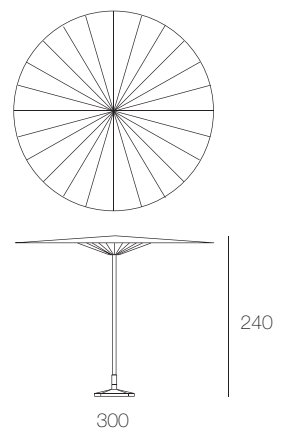

Mogambo
design CRS Paola Lenti

CA12A parasol

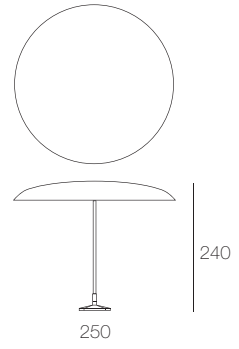

Clique
design Francesco Rota

CA14D square pouf

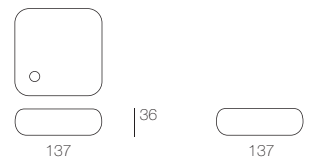

CA14E rectangular pouf

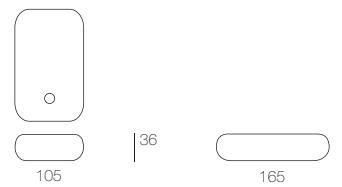

CA14A square side table



CA14B rectangular side table



Abri
design Francesco Rota

CA04DS left screen

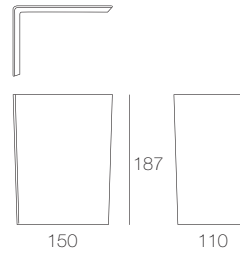

CA04CS left screen

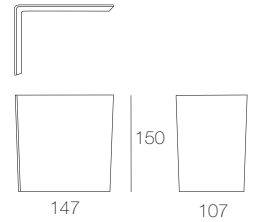

CA04DD right screen

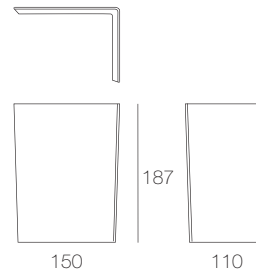

CA04CD right screen

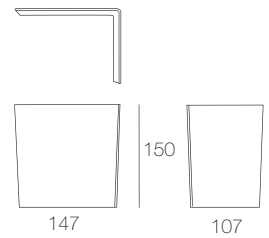

CA04F central screen

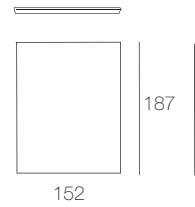

CA04E central screen

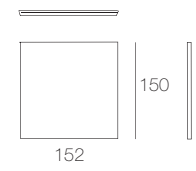

Greenery
design CRS Paola Lenti con Verde Profilo

AC232D low structure



AC232B high structure

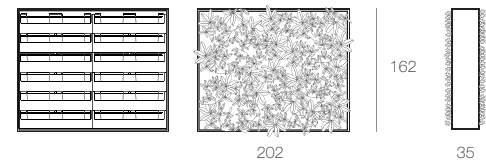

Shield
design Bestetti Associati

AC204 planter cover

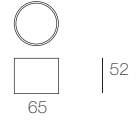

AC202 planter cover

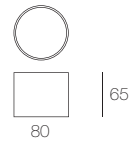

AC203 planter cover

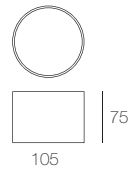

AC207 planter cover

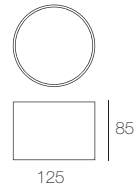

AC206 planter cover

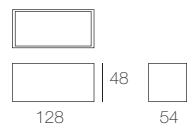

Bench
design Bestetti Associati

B64F planter

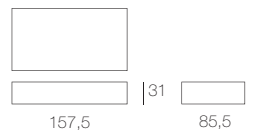

B64G planter

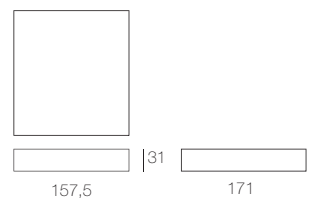

Plano
design Francesco Rota

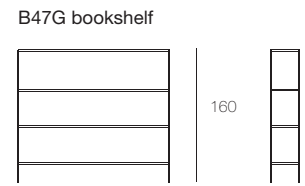
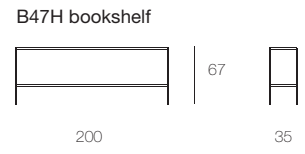

Lenta
design Davide Groppi, Bestetti Associati

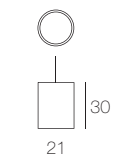
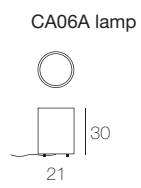

Shoji
design Davide Groppi con CRS Paola Lenti

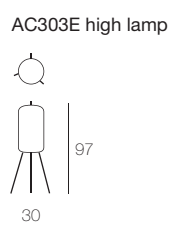
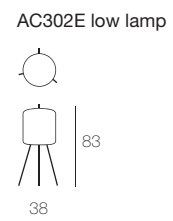

Taiki
design CRS Paola Lenti

AC315E lamp

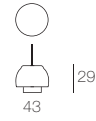

AC316E lamp

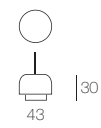

AC317E lamp

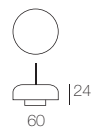

Agadir
design CRS Paola Lenti

AC337E little low lantern



AC336E little high lantern



AC332E cylinder low lantern

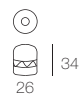

AC333E cylinder high lantern

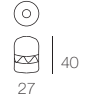

AC334E oval low lantern



AC335E oval high lantern



AC338E cosmo design lantern



FABRICS AND MATERIALS COLOURS RANGE

I materiali usati per i sistemi architettonici e i complementi da esterno di Landscapes Collection sono il risultato di un lungo e meticoloso percorso di sperimentazione e di ricerca.

I filati tecnici esclusivi Paola Lenti sono alla base della produzione di tessuti e di corde di rivestimento che abbinano qualità estetiche a elevate prestazioni funzionali: resistenza ai raggi UV, agli agenti atmosferici, all'acqua di mare e di piscina. L'azienda Paola Lenti è impegnata costantemente a migliorare la qualità e l'affidabilità dei filati, mantenendo sempre il necessario equilibrio fra prestazioni e rispetto per l'ambiente. Le strutture sono realizzate in acciaio, acciaio inox e alluminio, materiali selezionati per durare nel tempo e sottoposti a finiture che garantiscono la necessaria resistenza agli agenti atmosferici. I legni utilizzati sono protetti con sostanze naturali e maturano modificandosi nel colore, nella compattezza e nella struttura, senza che questo ne pregiudichi la qualità.

Facili operazioni, eseguite con costanza seguendo le istruzioni di manutenzione consigliate, possono limitare i danni causati da condizioni climatiche difficili, inquinamento, atmosfere marine o esposizione prolungata ai raggi del sole. I prodotti di Landscapes Collection sono coordinati, per materiali e colori, alle sedute di Aqua Collection e ai tappeti della collezione High Tech.

The materials used for the architectural systems and the outdoor complements in the Landscapes Collection are the outcome of a long and meticulous experimentation and research process. Paola Lenti's signature high tech yarns are the basis for the production of upholstery fabrics and cords, that combine aesthetics and functional performances: resistance to UV rays, to atmospheric agents, sea and swimming pool water. Paola Lenti as a Company is committed to constantly improve the quality and the reliability of the yarns, while keeping the best balance between performances and respect for the environment.

The structures are made of steel, stainless steel and aluminium, selected because of their endurance over the years; they go through special finishing processes that guarantee the required resistance to atmospheric agents.

The woods are protected with natural substances and age over time, as it normally occurs, changing in color, compactness and structure, without this affecting their quality.

Simple operations, carried out on a regular basis following the recommended maintenance instructions, can limit the damages caused by difficult climate conditions, pollution, marine atmospheres or by a prolonged exposition to sun rays.

Landscapes Collection products can be combined, through materials and colours, with the seating in the Aqua Collection and with the High Tech rugs.

Les matériaux utilisés pour les systèmes architecturaux et les compléments pour l'extérieur de Landscapes Collection sont le résultat d'un long et minutieux chemin d'expérimentation et de recherches.

Les fils techniques exclusifs à Paola Lenti sont à la base de la production de tissus et de cordes de revêtement qui unissent leurs qualités esthétiques à des performances fonctionnelles élevées: forte résistance aux rayons UV, aux agents atmosphériques, à l'eau de mer et de piscine. La Maison Paola Lenti travaille sans cesse à améliorer la qualité et la fiabilité des fils, tout en gardant l'équilibre nécessaire entre les performances techniques et le respect de l'environnement.

Les structures sont réalisées en acier, acier inox et aluminium, matériaux sélectionnés pour durer au fil des ans et protégés par des finitions qui assurent la résistance nécessaire aux agents atmosphériques.

Les bois utilisés sont protégés avec des produits naturels et vieillissent en changeant de coloris, d'aspect et de structure, sans que cela en affecte la qualité.

Des opérations faciles, exécutées régulièrement en suivant les instructions d'entretien conseillées, peuvent limiter les dommages causés par des conditions climatiques difficiles, par la pollution, les atmosphères marines ou par une exposition prolongée aux rayons du soleil.

Les produits de Landscapes Collection sont proposés dans des matériaux et des coloris coordonnés aux sièges de Aqua Collection et aux tapis de la collection High Tech.

Los materiales utilizados para los sistemas arquitectónicos y los complementos para exterior de Landscapes Collection son fruto de un largo y meticuloso proceso de experimentación y de investigación.

Con las fibras técnicas exclusivas de Paola Lenti se producen tejidos de tapizado y cordones con calidad estética y rendimientos funcionales: resistencia a los rayos UV, a los agentes atmosféricos y al agua salada o clorada.

La Compañía Paola Lenti está comprometida en la mejora constante de la calidad y fiabilidad de las fibras, buscando el equilibrio además entre su rendimiento y el respeto al medio ambiente. Las estructuras se fabrican en acero, acero inox y aluminio; todos son materiales seleccionados para durar a lo largo del tiempo y se someten a tratamientos que garantizan la necesaria resistencia a los agentes atmosféricos. Las maderas están protegidas con sustancias naturales y envejecen cambiando de color, consistencia y estructura, sin que esto afecte a su calidad.

Es necesario realizar regularmente el mantenimiento aconsejado para limitar los daños causados por condiciones climáticas difíciles, contaminación medioambiental, atmósferas marinas o por la exposición prolongada a los rayos del sol.

Los materiales y colores de la colección Landscapes se coordinan con todos los asientos tapizados de Aqua Collection y con las alfombras High Tech.

Die für die architektonischen Konstruktionen und ergänzenden Outdoor-Produkte der Landscapes Collection verwendeten Materialien sind das Ergebnis eines langen und gewissenhaften Versuchs- und Forschungsprozesses. Mit den exklusiven technischen Garnen von Paola Lenti werden ästhetische Bezugstoffe und -seile hergestellt, die hohe Leistung bieten: sie sind gegen UV-Strahlen, Witterungseinflüsse, Meerwasser und Chlorwasser beständig. Die Firma Paola Lenti hat sich der ständigen Verbesserung der Qualität und der Zuverlässigkeit der Garne verpflichtet, berücksichtigt dabei jedoch stets die optimale Balance zwischen technischer Leistung und Umweltschutz.

Die Gestelle sind aus Stahl, rostfreiem Stahl oder Aluminium gefertigt. Materialien, die wegen ihrer Langlebigkeit ausgewählt und mit besonderen Verfahren weiterbehandelt werden, um die nötige Witterungsbeständigkeit zu gewährleisten. Die verwendeten Hölzer werden mit natürlichen Substanzen geschützt und unterlaufen einem natürlichen, normalen Alterungsprozess. Veränderungen der Farbe, Materialdicke und der Struktur beeinträchtigen nicht die Qualität des Holzes.

Eine einfache, regelmäßige Pflege unter Berücksichtigung der empfohlenen Anleitung kann Schäden durch raue Witterungen, Verschmutzung, Meeresklima oder längere Einwirkung von Sonnenlicht vermeiden.

Die Produkte der Landscapes Collection sind nach Materialien und Farben aufeinander abgestimmt und passen zu den Sitzelementen der Aqua Collection und den Teppichen der High-Tech Kollektion.

Rope
Corda 10
 Agadir
 Taiki



T3229



T2932



T3237



T137
solid colour



T3729



T3719



T1937



T136
solid colour



T2905



T0537



T0529



T105
solid colour



T0519

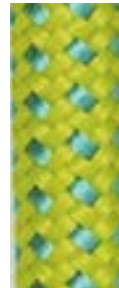

T0531



T0528



T0503



T0515



T3728



T1928



T2837



T2835



T128
solid colour



T2819



T2813



T2803



T2811



T2815



T2859



T2862



T2831



T6328



T5935



T5928



T5963



T5937



T5919



T6268



T6267



T5931



T5907

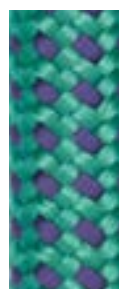

T5967



T5957

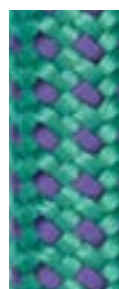

T5968



T6206

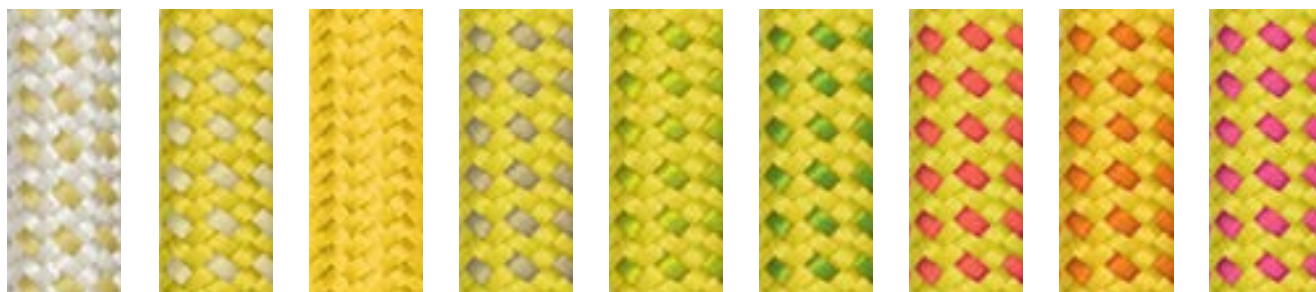

T3735 T3537 T135 solid colour T3536 T3505 T3528 T3511 T3503 T3515

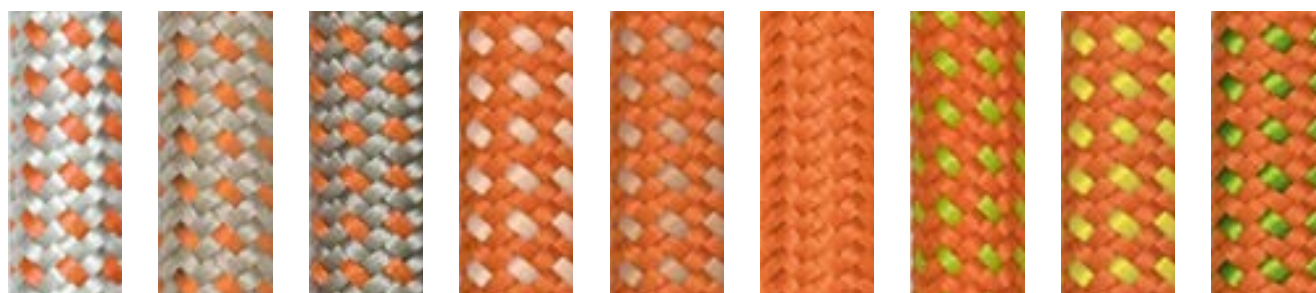

T2903 T3603 T1903 T0337 T0336 T103 solid colour T0305 T0335 T0328

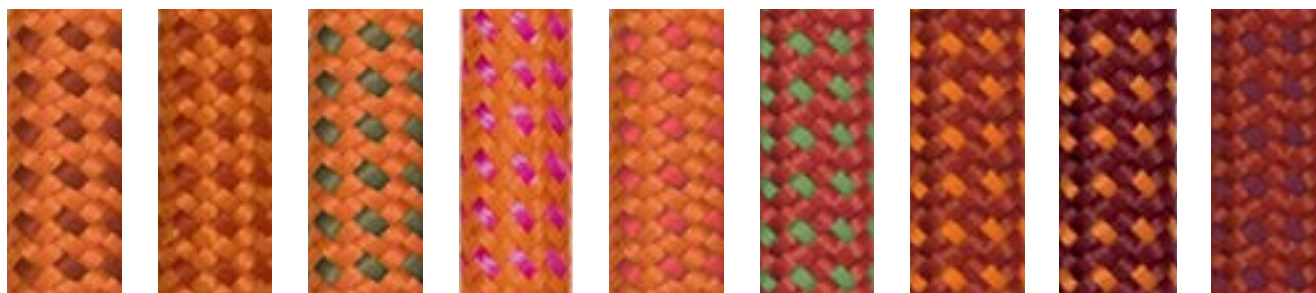

T0314 T0318 T0313 T0315 T0311 T1128 T1803 T1403 T1814

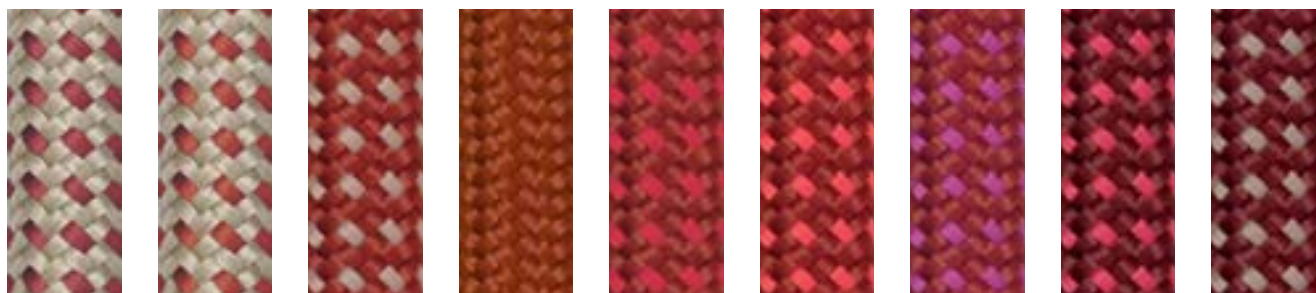

T3614 T3618 T1836 T118 T1856 T1811 T1815 T1411 T1419



T5503 T5515 T5511 T5603 T6611 T5614 T6668 T6606 T5611



T3611



T111
solid colour



T1115



T6656



T6618



T1103



T1118



T5672



T5615



T1119



T1114

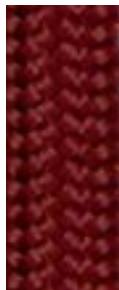

T114
solid colour

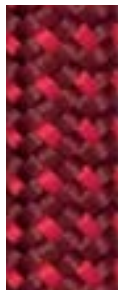

T1456



T1418



T1466



T1416



T1407



T1420



T3769



T6937



T6929



T6931



T6919



T6907



T2915



T1529



T1531



T3615



T1915



T115
solid colour



T1511



T1518



T1514



T1526



T1507

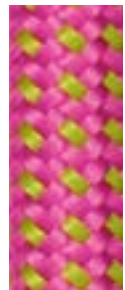

T1505



T1528



T1503



T6620



T6614



T1415



T0715



T0711

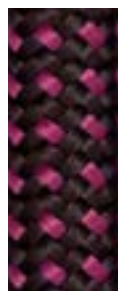

T2066

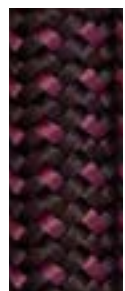

T2014



T6766



T0671



T0616



T1606



T116
solid colour



T6807



T6829



T1619



T1612



T6859



T6862



T6762



T6731



T6734



T6756



T6712



T6706



T6757



T5715



T5731

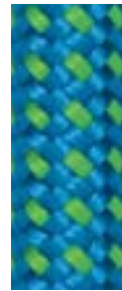

T5728



T5707



T5826



T5807



T5866



T7478



T7578



T2931



T3129



T131
solid colour

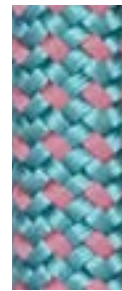

T3169



T3115



T3168

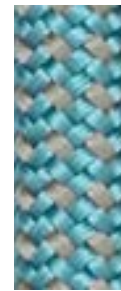

T3119



T3107



T3106

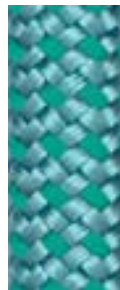

T3159

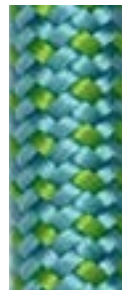

T3128

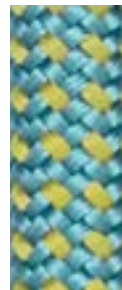

T3152



T3105



T6277

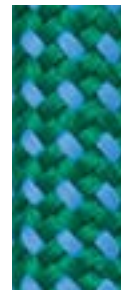

T7874



T7857



T6258



T7372



T132
solid colour



T129
solid colour



T3736



T3708



T0837



T108
solid colour



T119
solid colour



T3637



T3713



T3613



T1925



T1905



T3628



T1914



T1918



T1916



T1913



T1926



T1337



T1328



T1303



T113
solid colour



T1319



T1312

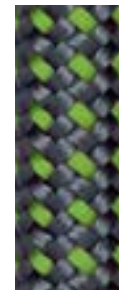

T0728



T2028

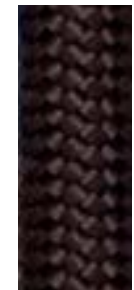

T120
solid colour

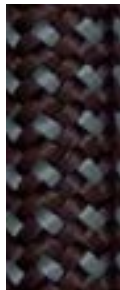

T2007



T2026



T2016

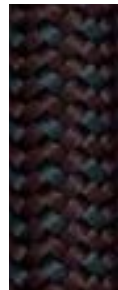

T2017



T2006



T1720



T1620

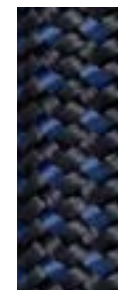

T1712

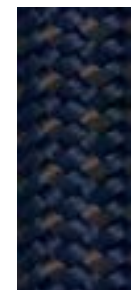

T1220



T2926



T2513



T2620

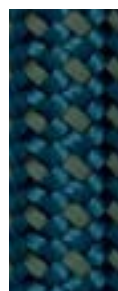

T2625



T2526



T2506



T2534



T125
solid colour

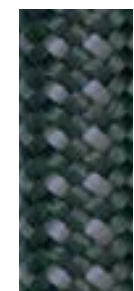

T2507



T8334

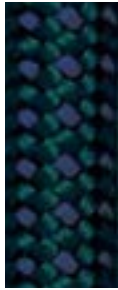

T8312



T8307



T183



T8313



T8316



T8320



T2619



T2607



T106
solid colour



T0607



T0612



T0626



T1206



T3406



T0620



T112
solid colour



T1216



T126
solid colour



T134
solid colour



T3407



T2526



T2512



T1225



T3425



T0726



T0720



T2907



T0729



T107
solid colour

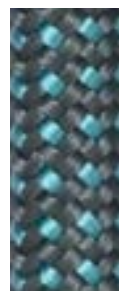

T0731



T0759



T0712



T0734



T1207



T1217



T117
solid colour

Rope
Corda Samo
 Mogambo



CS87



CS77

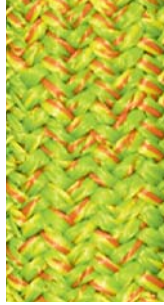

CS158



CS179

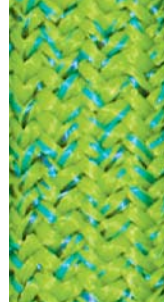

CS176



CS92

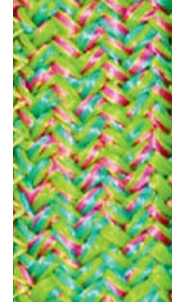

CS113



CS76



CS166



CS89



CS79

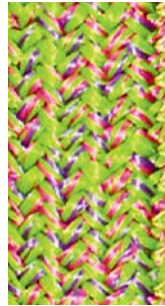

CS116



CS114



CS169



CS153



CS152



CS84



CS61



CS165

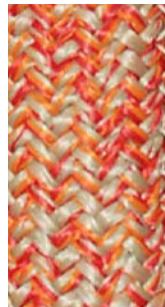

CS121

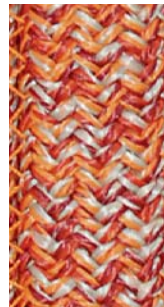

CS94

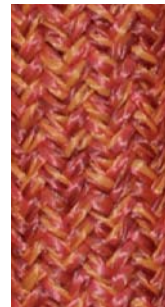

CS109



CS195



CS196



CS118



CS182

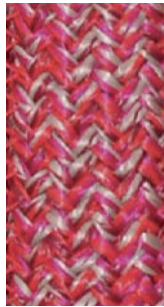

CS167

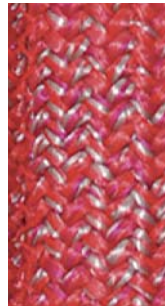

CS141

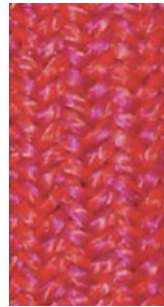

CS178



CS115

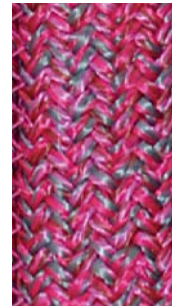

CS82



CS143



CS183



CS104

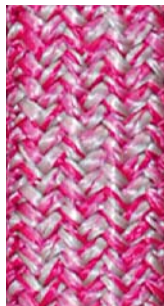

CS164



CS147

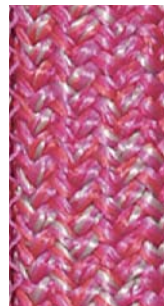

CS148

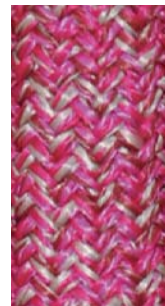

CS83

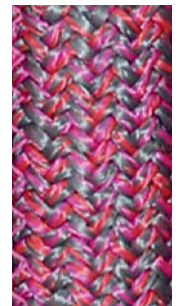

CS96



CS72

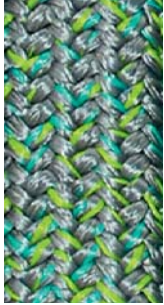

CS97

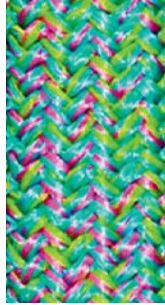

CS122



CS119



CS111

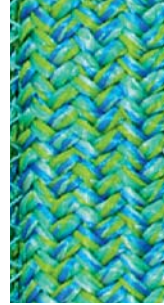

CS98



CS93

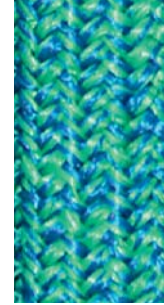

CS149



CS162



CS150



CS161



CS68

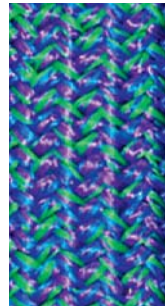

CS180

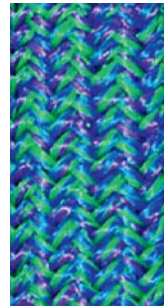

CS107



CS171



CS73



CS194



CS193



CS181



CS126



CS192



CS63



CS137



CS117



CS160



CS120



CS64



CS189



CS188



CS151

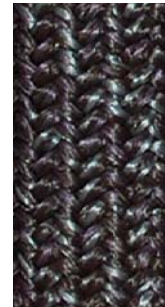

CS123



CS184



CS190



CS191



CS74



CS163

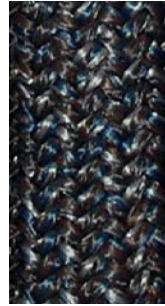

CS154



CS185



CS187



CS186

Brio
fabric
Clique



BT293705



BT373735



BT373505



BT293728

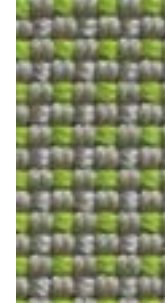

BT361905

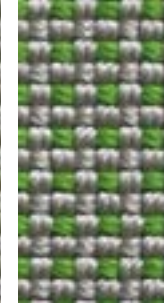

BT191928



BT363628



BT053519



BT051937

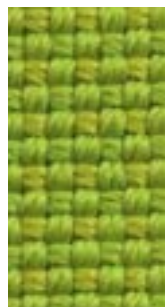

BT050535



BT050531



BT050515



BT050528



BT282805



BT282831



BT190503



BT053503



BT052818



BT050336

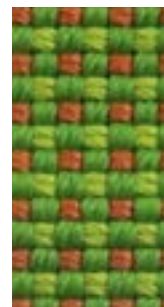

BT280305



BT281519



BT281505

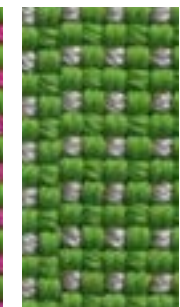

BT282819



BT032805

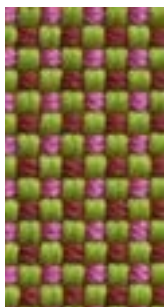

BT051518

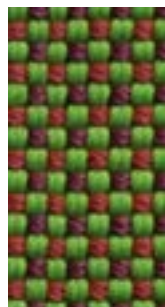

BT281814

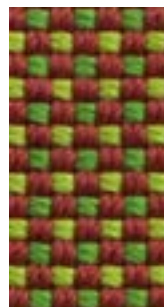

BT182805

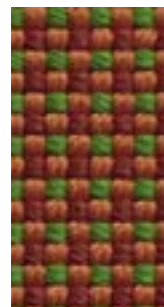

BT032818



BT181828



BT142818



BT282813



BT281319



BT282859



BT281959

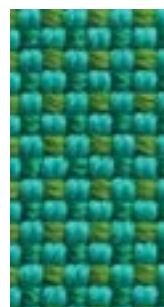

BT592864

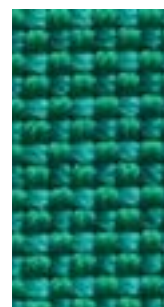

BT645962



BT313728



BT592819

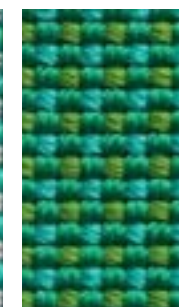

BT645928

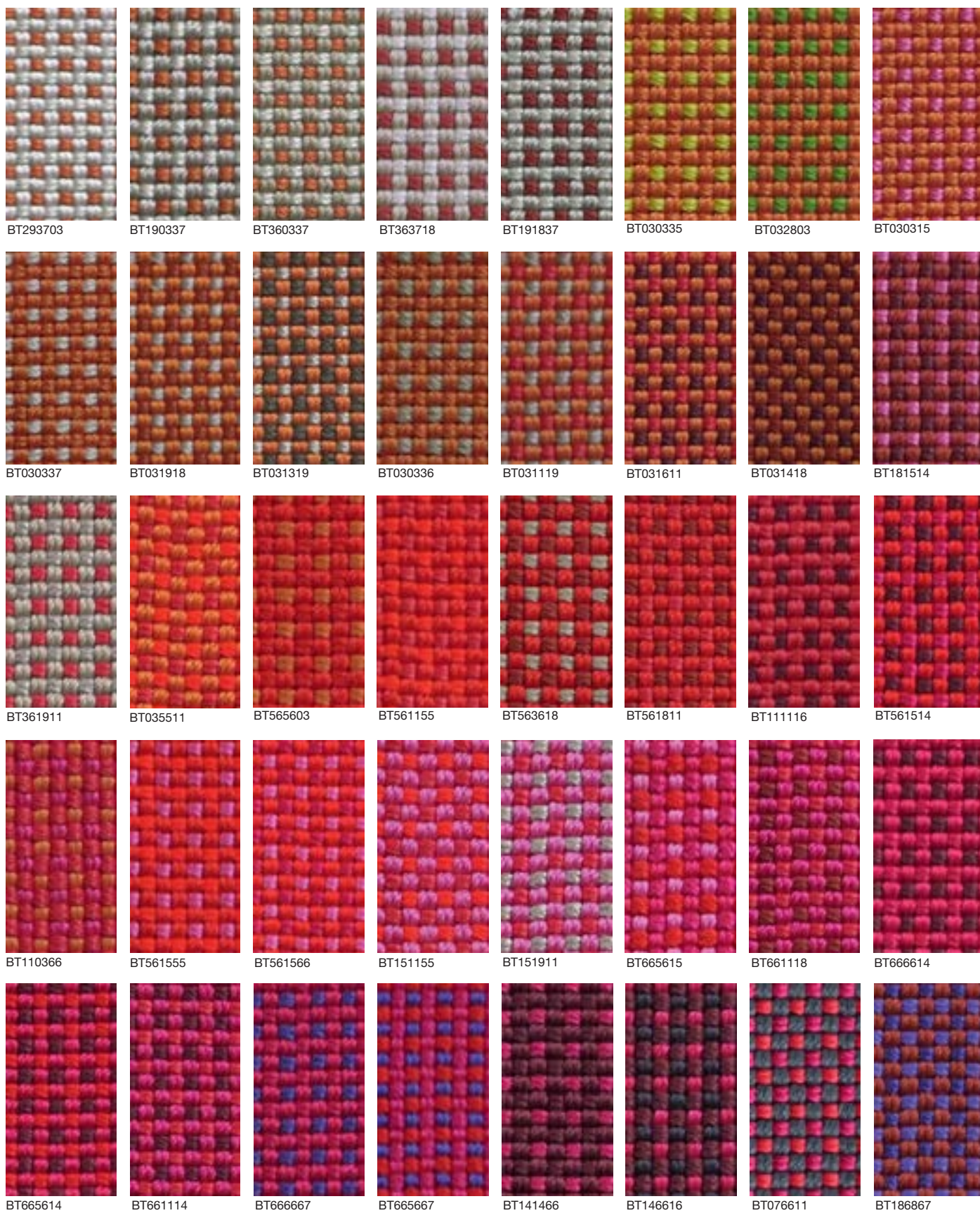



BT191436



BT141419

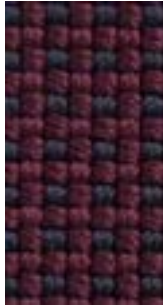

BT141416

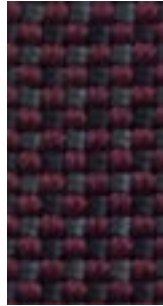

BT140716

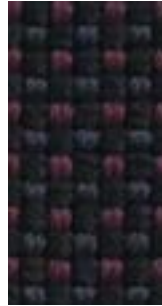

BT201416

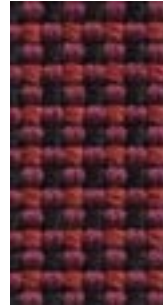

BT141820

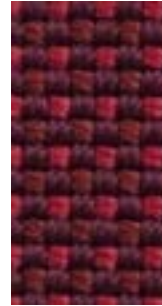

BT141811

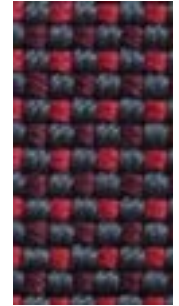

BT071411



BT141403



BT181814

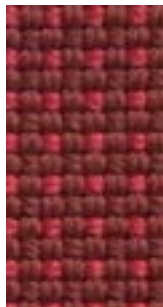

BT181811



BT141411

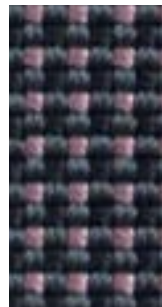

BT076916

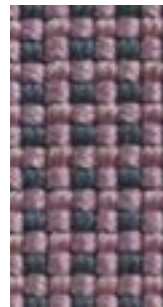

BT696907



BT691929

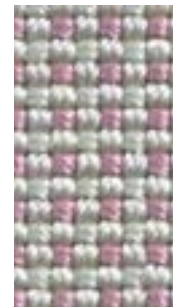

BT373769



BT292915



BT192915



BT363715



BT151529

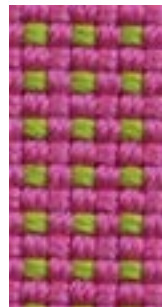

BT151505



BT151503



BT151511

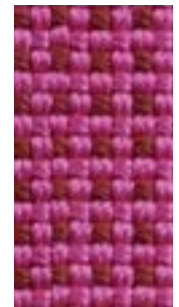

BT151518



BT151514



BT151507

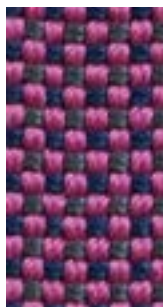

BT150706



BT070715

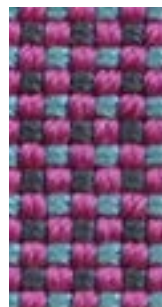

BT153107



BT156867

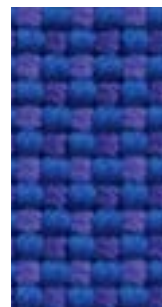

BT586867

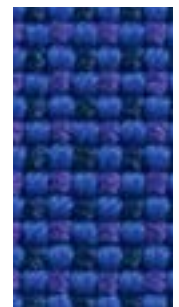

BT586706



BT671466



BT673407

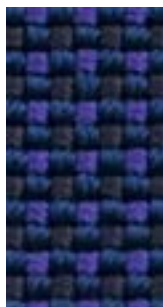

BT066716

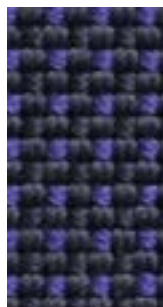

BT161667



BT580634



BT206757

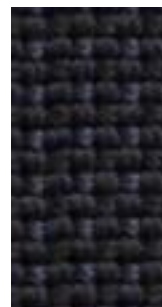

BT202016

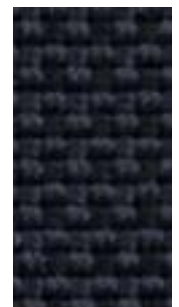

BT161620



BT323229



BT292931



BT313129



BT155962

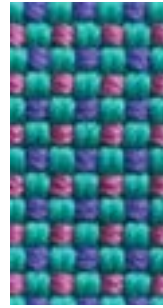

BT596815

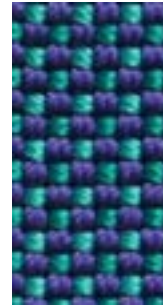

BT675962



BT586762



BT675862



BT595931

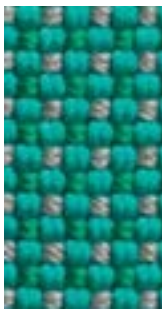

BT591964

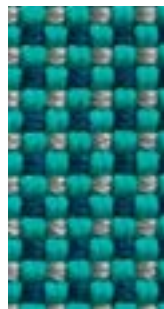

BT591934



BT595758

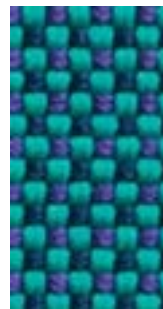

BT596706



BT581659

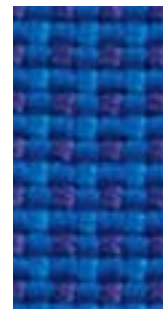

BT585767

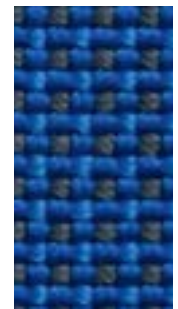

BT585707



BT313107



BT071631

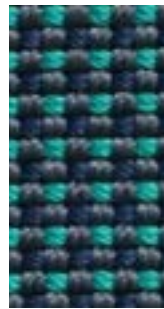

BT075906

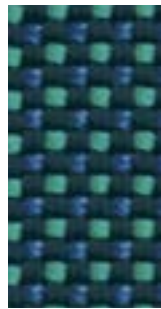

BT345906



BT066234



BT163406

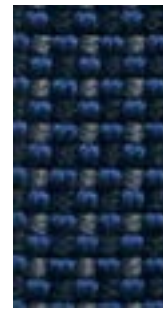

BT060712

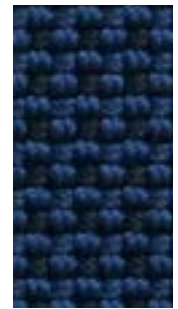

BT060612



BT072606

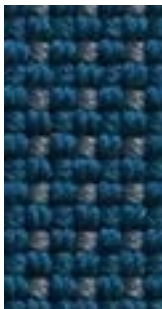

BT260726



BT062634



BT250634



BT262620



BT262017



BT121206

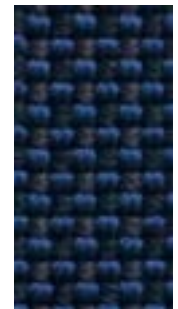

BT063416

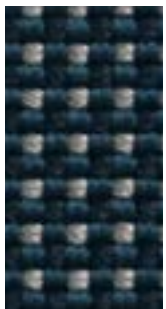

BT251912

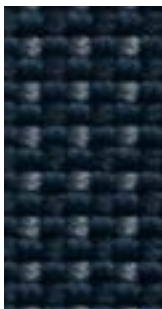

BT340712

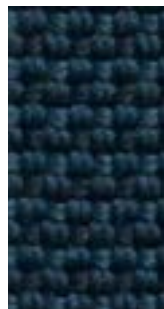

BT341725

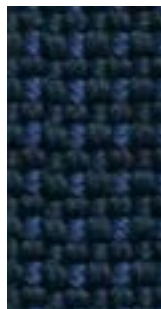

BT343406

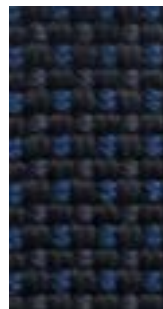

BT201606

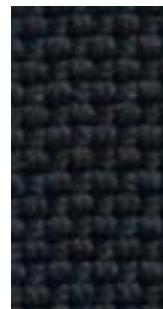

BT201234



BT342012

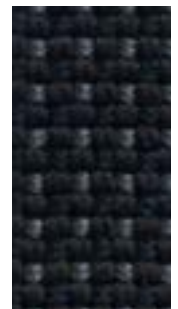

BT201207



BT831336

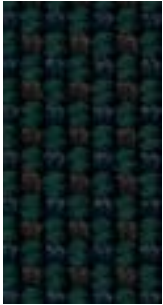

BT832034

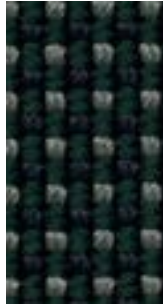

BT831207

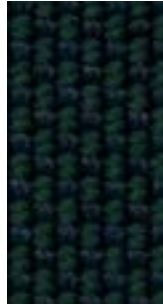

BT831234

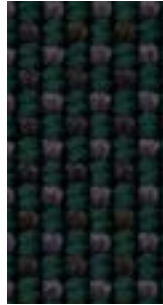

BT832016

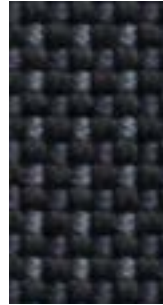

BT200716

**Rope T
fabric**
Clique



RT32 bianco



RT37 ghiaccio



RT29 silver



RT19 cemento



RT36 sand

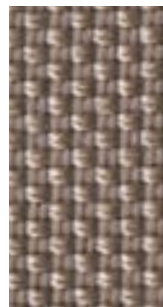

RT08 bruno



RT35 limone



RT03 arancio



RT18 terracotta

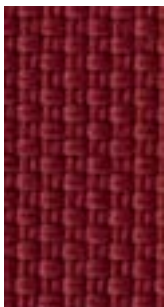

RT14 bordeaux



RT11 corallo

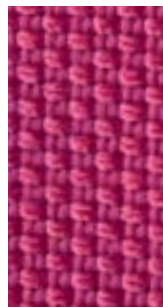

RT15 fucsia

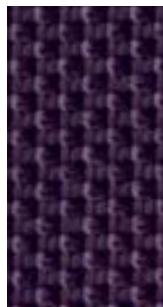

RT16 viola

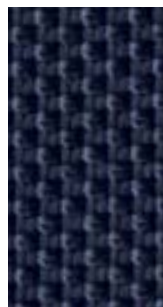

RT06 blu

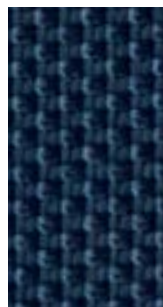

RT34 blu marino

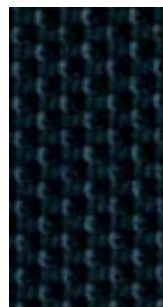

RT12 notte

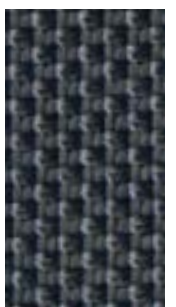

RT07 grigio



RT05 verde mela

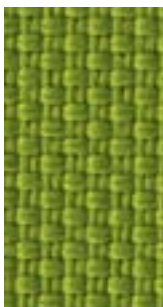

RT28 verde erba



RT31 acquamarina



RT26 ottanio



RT83 foresta



RT25 verde scuro

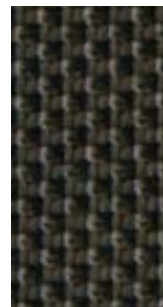

RT13 muschio

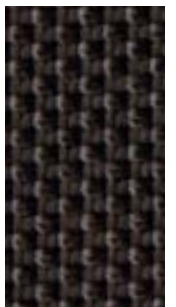

RT20 wengé

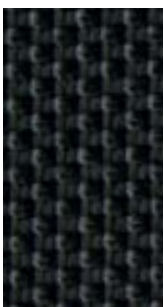

RT17 antracite

**Polyester
net**
Ombra

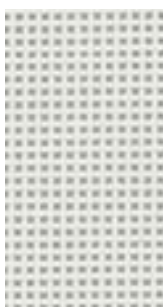

RE32 bianco

Thuia fabric

Abri
Cabanne
Ombra



TH32 bianco



TH36 sand



TH43 ruggine



TH16 mora



TH02 sottobosco



TH76 oliva



TH25 foresta



TH13 basalto

Thuia mélange fabric

Selection from
colours range.
Abri
Cabanne
Ombra



TH437636



TH433676



TH431676



TH360243



TH251643



TH431616

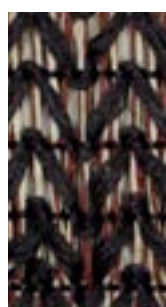

TH433616



TH360216



TH130202



TH130213



TH130216



TH250216

Shade fabric

Cabanne



SH36 sand

Tamil fabric
Ala
Bistrò
Pavilion
Resort

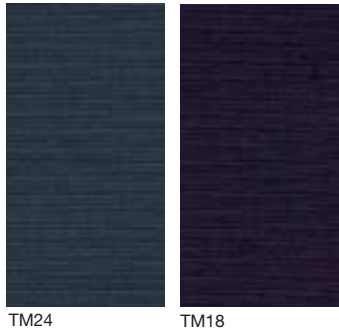
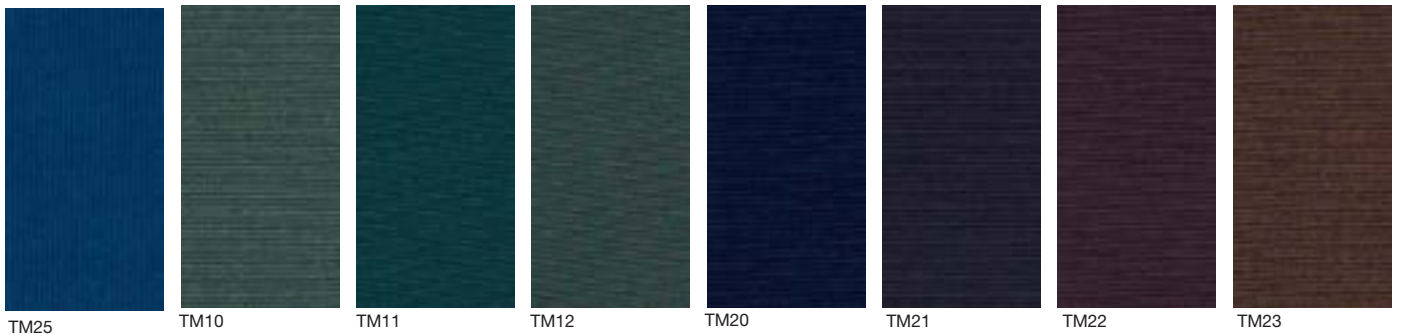
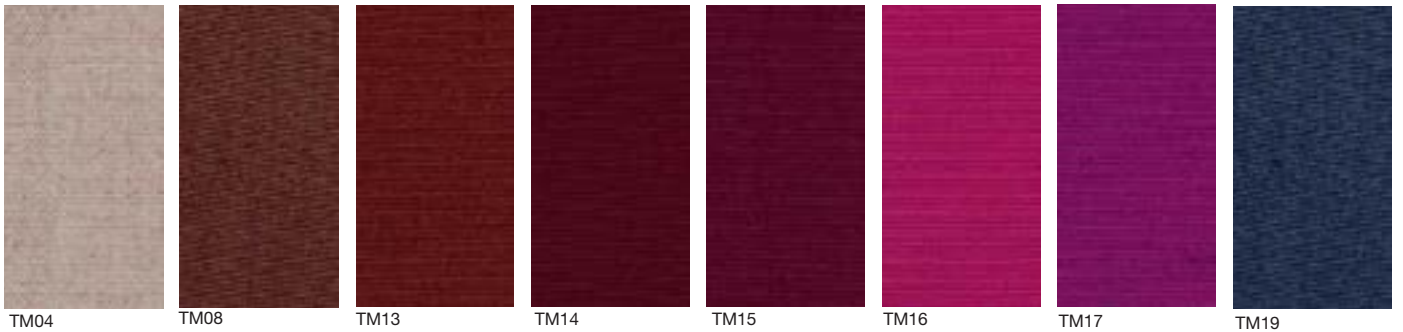
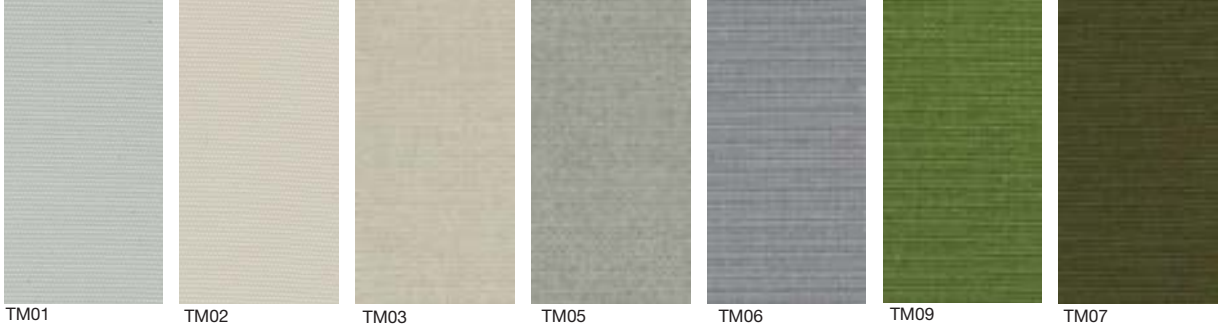

Madras fabric
Ala
Bistrò
Pavilion
Resort

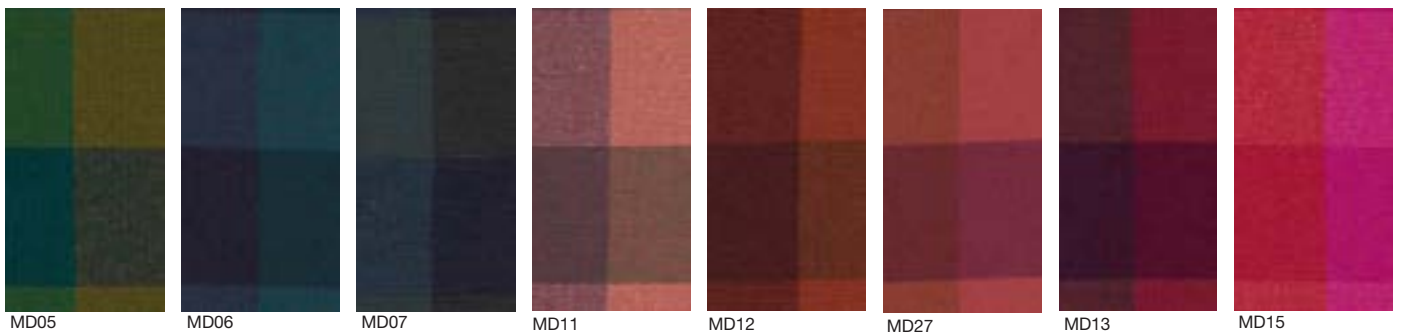
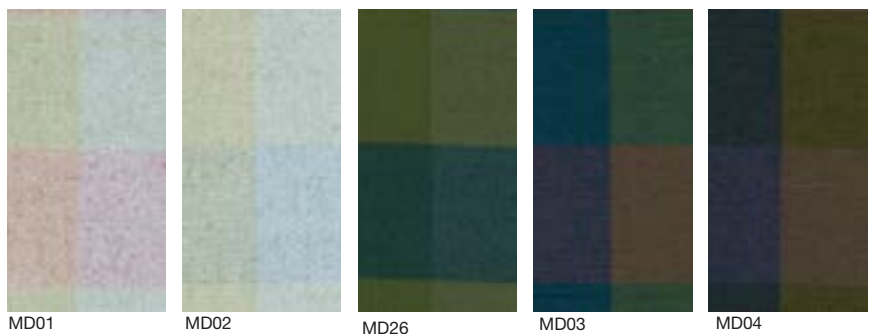



MD16



MD17



MD25



MD08



MD18



MD19



MD20



MD21



MD22



MD23



MD24



MD10

**Polyester
fabric**
Ala
Pavilion
Resort



PY32 bianco

Metal finishing

Ala
Bench
Bistrò
Cabanne
Clique
Greenery
Mogambo
Pavilion
Resort
Shield

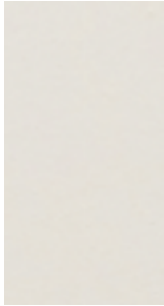

ME002 avorio



ME443 ruggine



ME416 mora



ME444 sottobosco



ME476 oliva



ME425 foresta



ME445 basalto

Metal finishing

Plano



ME002 avorio

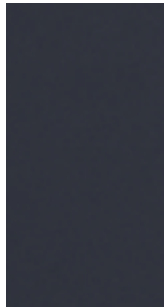

ME021 grafite

Concrete

Plano



032 avorio



007 grafite

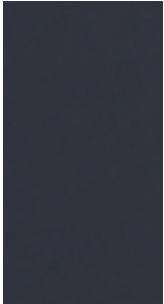

ME021 grafite

Pulire regolarmente con un panno umido, eventualmente con l'aggiunta di detergente neutro.

Regularly clean with a wet cloth, eventually adding some neutral detergent.

Nettoyez régulièrement avec un chiffon humide; ajoutez éventuellement du détergent neutre.

Limpie regularmente con un paño humedo, posiblemente con la adición de un detergente neutro.

Regelmäßig mit einem feuchten Tuch abwischen, bei Bedarf kann ein neutrales Reinigungsmittel zugegeben werden.

Proteggere periodicamente la superficie superiore e inferiore dei piani con cera d'api dopo averli puliti con acqua e detergente neutro.

Periodically protect the upper and lower surfaces of the tops with beeswax after you have cleaned them with water and neutral detergent.

Protégez périodiquement les surfaces supérieure et inférieure des plateaux avec de la cire d'abeilles, après les avoir nettoyées à l'eau et détergent neutre.

Proteja periódicamente la superficie superior y inferior de los sobres con cera de abeja después una limpieza con agua y detergente neutro.

Die oben- und untenliegenden Flächen nach dem Reinigen mit Wasser und Neutralreiniger mit Bienenwachs schützen.

Sassafras wood

Cabanne



1



2



3

Accoya® wood

Plano



1



2



3

1 Nuovo, new, neuf, nueva, neuf.

2 Maturazione dopo media esposizione, aging after medium exposition, maturation après une exposition moyenne, envejecimiento después de una media exposición, Reifung nach mittelfristiger Belichtung.

3 Maturazione dopo lunga esposizione, aging after long exposition, maturation après une exposition longue, envejecimiento después de una larga exposición, Reifung nach langfristiger Belichtung.

I trattamenti ai quali sono sottoposti i legni di Landscapes Collection nutrono e proteggono il materiale, ma non lo rendono impermeabile e non escludono la maturazione, l'ossidazione e la fessurazione delle superfici, fenomeni del tutto normali e legati alla natura del materiale.

Rinnovare periodicamente il trattamento oleo-idrorepellente originale con un impregnante a base di cera d'api, olio di canapa e acqua, seguendo attentamente le istruzioni d'uso.

The treatments applied to Landscapes Collection woods nourish and protect the material, but do not make it waterproof and do not prevent surfaces from aging, oxidation and cracking. These phenomena are entirely normal and due to the nature of the material.

Periodically repeat the original oil and water repellent treatment with a primer composed of beeswax, hemp oil and water, carefully following the instructions.

Les traitements appliqués aux bois de Landscapes Collection nourrissent et protègent le matériau, mais ne le rendent pas imperméable et n'empêchent pas le vieillissement, l'oxydation et la fissuration des surfaces, des phénomènes tout à fait normaux et dû à la nature du matériau.

Renouvelez périodiquement le traitement contre l'eau et les matières grasses avec un produit d'imprégnation composé de cire d'abeille, huile de chanvre et d'eau, en suivant soigneusement les instructions.

Los tratamientos aplicados a las maderas de la Landscapes Collection nutren y protegen el material, pero no lo hacen resistente al agua y no excluyen el envejecimiento, la oxidación y la rotura de la superficie, fenómenos que son completamente normales y debidos a la natura del material.

Renueva periódicamente el tratamiento repelente à l'agua y al aceite con productos al agua, aceite de cáñamo y cera de abeja, siguiendo cuidadosamente las instrucciones.

Die besondere Behandlung der Hölzer der Kollektion Landscapes schützt und pflegt das Material, macht es jedoch nicht wasserabstoßend und verhindert nicht die Reifung, die Oxydation und das Einreißen der Oberflächen; diese Erscheinungen sind ganz normal und der Natur des Materials verbunden.

Erneuern Sie periodisch die originelle Öl- und wasserabstoßende Behandlung mit einem Imprägnierungsmitteln aus Bienenwachs, Hanföl und Wasser, nach den Anweisungen.

Paola Lenti srl si riserva il diritto di apportare modifiche tecniche e dimensionali e di introdurre miglioramenti che potrebbero cambiare l'estetica dei prodotti presentati in catalogo. I riferimenti colore stampati non sono vincolanti.

Paola Lenti srl reserves the right to alter the technical and dimensional specifications given in this publication and to introduce improvements that may change the aesthetics of the products shown in this catalogue. The printed colours hues are not binding.

Paola Lenti srl se réserve le droit d'apporter des modifications techniques et de dimensions, ainsi que d'introduire des améliorations qui peuvent changer l'esthétique des produits présentés. Les tonalités imprimées ne engage pas la société.

Paola Lenti srl se reserva el derecho de cambiar tamaños y especificaciones técnicas de los productos listados en esta publicación, así como el de introducir mejoras que puedan cambiar la estética de los mismos. Por favor tengan en cuenta que los colores de los tejidos mostrados en fotografía no son totalmente fidedignos.

Paola Lenti srl behält sich das Recht vor, Änderungen an technischen Angaben und Dimensionen in diesem Katalog vorzunehmen, und Verbesserungen einzuführen, die die Ästhetik der gezeigten Produkten verändern können. Die ausgedrückten Farben- Tönen sind nicht verbindlich.

Index by collections

Shading structures	6
Cabanne	8
Modulo Quadro	10
Modulo Veranda	40
Modulo Tunnel	48
Pavilion	56
Ala	78
Resort	96
Complements, lighting	112
Ombra	114
Bistrò	124
Clique	124
Mogambo	138
Abri	144
Plano	156
Greenery	162
Shield	172
Bench	172
Lenta	184
Shoji	186
Taiki	188
Agadir	192
Technical details	196
Fabrics and materials	214

Index by products

Abri	144
Agadir	192
Ala	78
Bench	172
Bistrò	124
Cabanne	8
Modulo Quadro	10
Modulo Veranda	40
Modulo Tunnel	48
Clique	124
Greenery	162
Lenta	184
Mogambo	138
Ombra	114
Pavilion	56
Plano	156
Resort	96
Shield	172
Shoji	186
Taiki	188

Photo Sergio Chimenti

Page 76, 77

Klein Bottle House, McBride Charles Ryan Architecture - Australia
photo John Gollings

Paola Lenti srl
Via Po, 100 A
20821 Meda MB Italia
ph. +39 0362 344587
fx. +39 0362 71204
info@paolalenti.it
www.paolalenti.com

capitale sociale € 800.000,00 i.v.
C.C.I.A.A. di Milano
R.E.A. MB 1350348
c.f. e p.iva IT02100810965