

jardinico®

CARACTÈRE

CARACTÈRE
PREMIUM SHADE 2022



jardinico[®]



PREMIUM
shade

An intuitive view on shade solutions paying tribute to craftsmanship and technical insight was translated into the Caractère collection. A premium outdoor umbrella allowing unlimited shade possibilities and discreet luxury to your garden or terrace. Quality, aesthetics and durability merge together in a modern, chic and demanding world on exterior living.

Caractère creates an elegant aesthetic that respects the architectural vision of any space. A collection that is designed with an eye for every detail and finished with the greatest care. Its versatile use makes each piece the perfect umbrella as a finishing touch for any outdoor area.

All Jardinico® Caractère designs are internationally registered.

PRODUCT TYPE	Mid pole aluminium	
	JCP.1 series	62
	JCP.2 series	64
	Free pole aluminium	
	JCP.3 series	68
	JCP.4 series	72
	JCP.5 series	78
	JCP.6 series	80

JCP.1 SERIES	Gallery	9
	Technical	
	JCP.102 - 230 x 230 cm	63

JCP.2 SERIES	Gallery	17
	Technical	
	JCP.201 - 400 x 400 cm	65
	JCP.202 - 500 x 500 cm	66
	JCP.203 - ø 450 cm	67

JCP.3 SERIES	Gallery	25
	Technical	
	JCP.301 - 300 x 300 cm	69
	JCP.302 - 260 x 260 cm	70
	JCP.303 - ø 350 cm	71

JCP.4 SERIES	Gallery	35
	Technical	
	JCP.401 - 370 x 370 cm	73
	JCP.402 - 425 x 300 cm	74
	JCP.403 - ø 400 cm	75
	JCP.404 - 250 x 350 cm	76

JCP.5 SERIES	Gallery	45
	Technical	
	JCP.501 - 4 * 300 x 300 cm	79

JCP.6 SERIES	Gallery	51
	Technical	
	JCP.601 - 2 * 300 x 300 cm	81

SPECIFICATIONS	Technical	61
	Materials	83
	Protection & maintenance	89



A perfect match for any project around the world, outdoor umbrellas that blend in seamlessly with the environment. Caractère One Series surprises thanks to its sturdiness.

With a canopy incline of 10°, the umbrella looks enormously flat, drawing attention to its sleek lines with an elegant touch.

JCP.1 SERIES

mid pole









Two series offers outdoor umbrellas that play a central role on your patio. A true eye-catcher, providing up to 25 m² of shade. Thanks to a telescopic system, you can smoothly open and close the sturdy umbrella at arm height without touching other furniture.

Despite their enormous strength, the umbrellas are very mobile and supported by a base of 158 kg - 348 lbs.

JCP.2 SERIES

mid pole



JCP.202 500 x 500 cm A01 white C003 pearl FLEXX bistro







The most iconic series from Caractère. Three Series includes umbrellas that are the heart of your garden, perfect for shelter and protection from the bright sun rays. Every model is extremely convenient to move and operate. By means of the slider, you can easily move this parasol into every desired position and turn it 360° without having to move its base.

JCP.3 SERIES

free pole





Caractère collection gets its strength from its frame. All parts of the frame are made from aluminium, such as the interior and the full opening system. An extra strong aluminium frame with a profile thickness of 3 mm and a seamless, elegant transition from the frame to the accompanying parasol base.

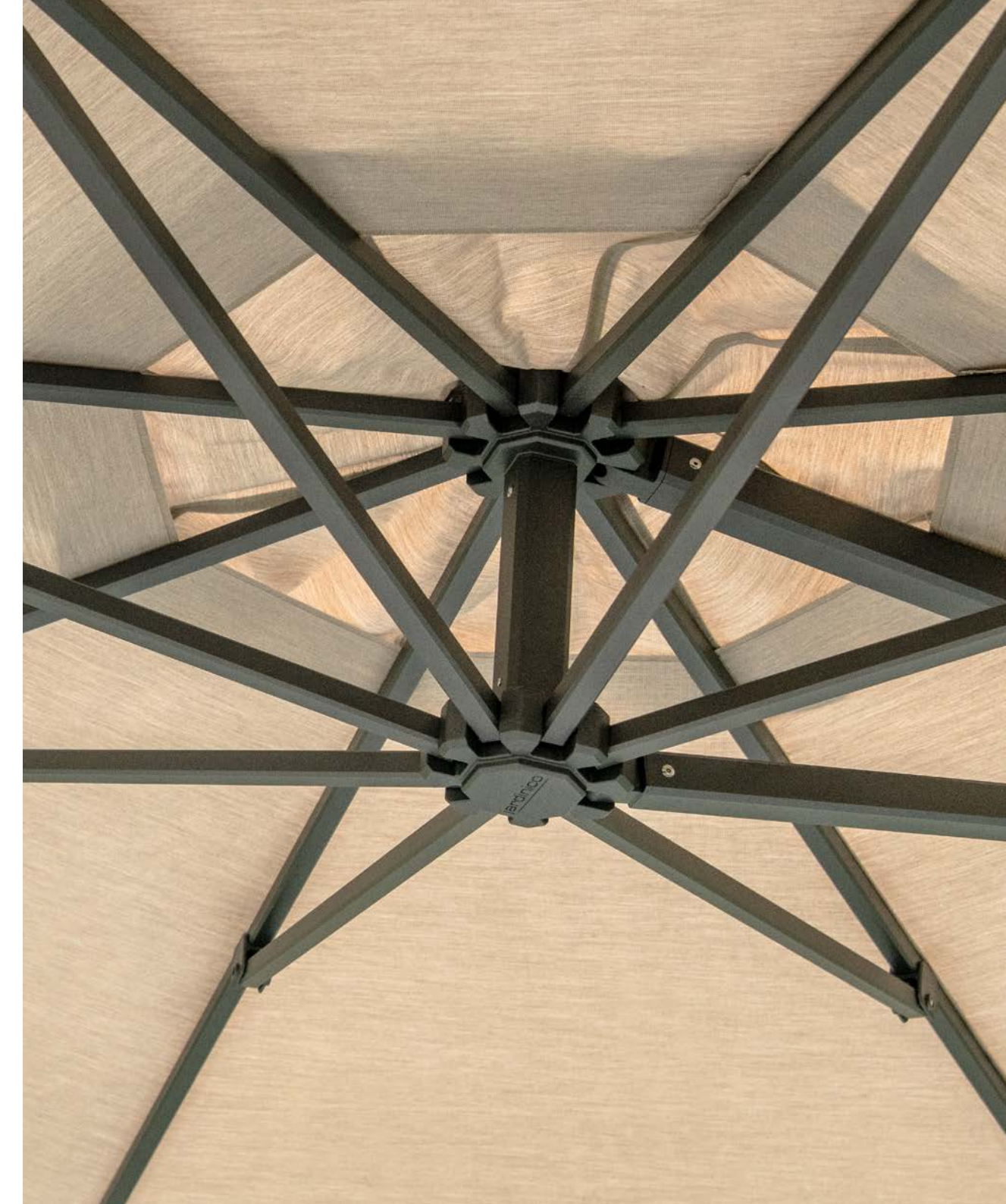



JCP.303 ø 350 cm A01 white C011 cotton VOLTE dining



JCP.301 300 x 300 cm A31 charcoal C305 umber FLEXX dining



Four series is home to a variety of environments all over the world. You may find them in both private use and large projects such as hotels, public buildings, resorts and pool areas.

An exceptionally sturdy outdoor umbrella with an elegant and luxurious appearance. Supported by a 245 kg - 540 lbs base and its dimensions, this series is the perfect marriage between Belgian design, enormous strength and guaranteed quality.

JCP.4 SERIES

free pole



JCP.404 250 x 350 cm A31 charcoal C011 cotton SCOOP lounge







JCP 402 425 x 300 cm A01 white C416 sapphire

The outdoor umbrella bases of Caractère were exclusively designed in Belgium. Hot galvanised and powder coated steel plates, each with a thickness of 15 mm, give a modern and sophisticated look to each base. The heavy weight provides extremely stable support for carefree enjoyment of the outdoors.



A sturdy full aluminium frame ensures that you can operate such a large umbrella with the greatest of ease. Tilt in height or turn your umbrella 360° around its axis, depending on the position of the sun and where you want your shade.



Five series has proven to be the ideal model for hospitality. With four separate outdoor umbrellas of 300 x 300 cm on one central pole, this model offers no less than 40 m² of shade. Each parasol can be tilted in height and opened individually.

Gutters are available to connect them to each other and enable large areas to have complete, uninterrupted coverage from the sun or rainy weather conditions.

JCP.5 SERIES

free pole



JCP.501 4* 300 x 300 cm A12 alu teak C003 pearl





JCP.501 3* 300 x 300 cm A12 alu teak C003 pearl FLEXX bistro



JCP.6 SERIES

free pole

An umbrella that will grace every large outdoor area by its Belgian design. The JCP.601 combines two outdoor umbrellas of 300 x 300 cm that can be opened, closed and tilted in height individually. Together they provide 18 m² of shade. Thanks to one pole, the space underneath can be used optimally which makes this sunshade ideal for catering projects.











Technical

SPECIFICATIONS

The representation of colours, dimensions and weights may differ from reality as may variations when a product is handmade. Dimensions and technical details are subject to change without prior notice. Jardinico reserves the right to make any improvements such as technological and aesthetical modifications to its models, including adjustments of sizes and materials when it comes to technical developments or availability of raw materials.

More information, accompanying videos about the collections and technical data sheets of each product can always be consulted or downloaded on our website www.jardinico.com.



JCP.1 SERIES

- ✓ Full aluminium frame.
- ✓ Light, compact and strong.
- ✓ Push-up system.
- ✓ Belgian design.
- ✓ Ideal for hospitality projects, smaller terraces or along the swimming pool.

FRAME	Mid pole umbrella with push-up system. Pole and ribs are aluminium powder coated. Pole profile: 40 x 40 x 1.5 mm, 1.6 x 1.6 x 0.06". Ribs profile: 22 x 22 x 1.6 mm, 0.9 x 0.9 x 0.06".
CANOPY	320g/m ² Sunbrella® Plus, 100% solution dyed acrylic. Fast stock: canopies available from stock.
BASE	Two hot galvanised steel plates, powder coated.
TILT & ROTATION	Not applicable.
WIND SPEED	43 km/h, 26.7 mph - Maximum wind speed to which the umbrella may be exposed.



JCP.102 - 230 x 230 cm

230 X 230 CM

UMJCP.102 FRAME & CANOPY

FIXED COMBO			A01C101 white & cloud
			A31C101 charcoal & cloud
			A32C208 black & black
			A12C001 alu teak & natural
			A31C101 charcoal & cloud
			A31C204 charcoal & night

UFJCP.102 FRAME

	A01 white		A02 silver
	A12 alu teak		A31 charcoal
	A32 black		

UCJCP.102 CANOPY

MIX & MATCH			C003 pearl		C011 cotton
			C100 ice		C207 onyx
			C305 umber		
			C107 mooncrest		C210 pitch
			C416 sapphire		
			Free pick: Other fabrics available upon request.		

UBJCP.1S BASE

	S01 white		S02 silver
	S31 charcoal		S32 black

PROTECTION COVER

	UPJCP.1S-X77 black
--	---------------------------

17 kg, 37.5 lbs nett
excl. base

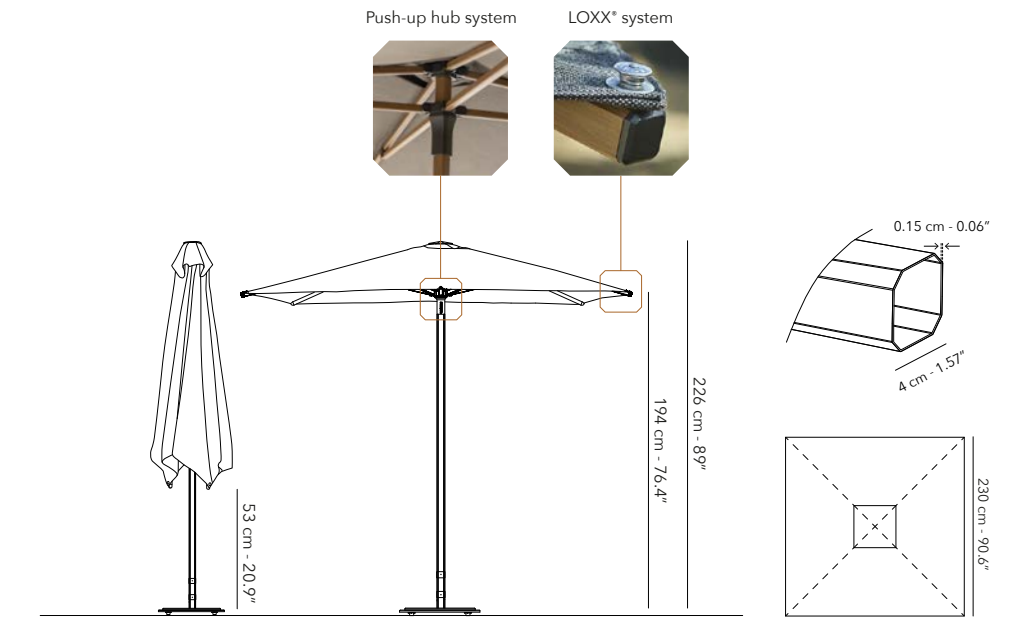

All dimensions exclude the base.
* Stainless steel LOXX® to easily attach the canopy to the frame and detach it.

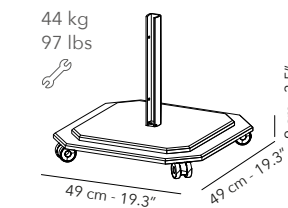

- BASE**
- Base with 4 wheels that rotate 360°, each with brakes to fix the umbrella.
 - Has the same colour as its frame.
 - For an alu teak frame, we provide a charcoal base.



JCP.2 SERIES

- ✓ Full aluminium frame.
- ✓ Large and robust with 25 m² of shade.
- ✓ **Telescopic opening system:** easy to open and close without touching other furniture.
- ✓ Gutters available to connect multiple umbrellas.
- ✓ Perfect for large terraces.

FRAME Mid pole umbrella with crank handle and telescopic opening system. Pole and ribs are aluminium powder coated. Pole profile: 80 x 80 x 2.8 mm, 3.2 x 3.2 x 0.1". Ribs profile: 32 x 32 x 1.6 mm, 1.3 x 1.3 x 0.06".

CANOPY 320g/m² Sunbrella® Plus, 100% solution dyed acrylic. Fast stock: canopies available from stock.

BASE 2 hot galvanised steel plates, powder coated.

TILT & ROTATION Not applicable.

WIND SPEED 58 km/h, 36 mph - Maximum wind speed to which the umbrella may be exposed.



JCP.201 - 400 x 400 cm



JCP.202 - 500 x 500 cm



JCP.203 - ø 450 cm

400 X 400 CM

UFJCP.201 FRAME

	A01 white		A02 silver
	A31 charcoal		

MIX & MATCH

UCJCP.201 CANOPY

	C003 pearl		C011 cotton
	C305 umber		
	C100 ice		C107 mooncrest
	C207 onyx		C210 pitch
	C416 sapphire	Free pick: Other fabrics available upon request.	

UBJCP.2S-3S BASE

	S01 white		S02 silver
	S31 charcoal		

UBIGB-JCP.2S-3S in ground base
UBOGB-JCP.2S-3S on ground base

PROTECTION COVER

	UPJCP.2S-X77 black
--	--------------------

GUTTERS p. 90

UAJCP.2S colour of the canopy

56 kg, 123.5 lbs nett
excl. base

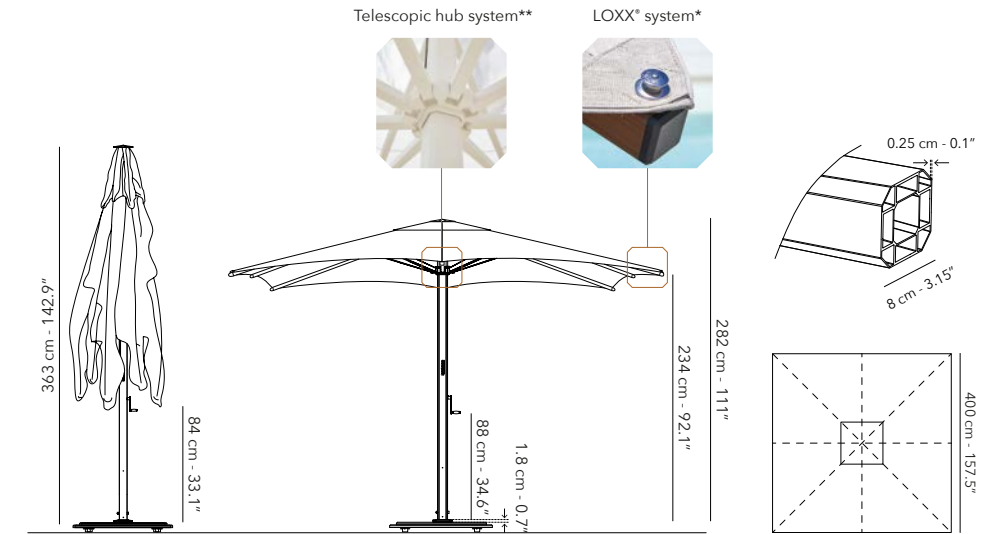

All dimensions exclude the base.
* Stainless steel LOXX® to easily attach the canopy to the frame and detach it.
** Easy to open and close without touching furniture.

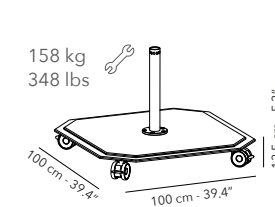

BASE

- Base with 4 wheels that rotate 360°, each with brakes to fix the umbrella.
- Has the same colour as its frame.

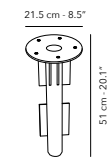

IN GROUND BASE

Anchored in the ground with concrete. Can not be moved.

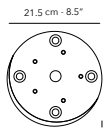

ON GROUND BASE

Only possible with a substrate where chemical anchoring is possible.

500 X 500 CM

UFJCP.202 FRAME

	A01 white		A02 silver
	A31 charcoal		

UCJCP.202 CANOPY

	C003 pearl		C207 onyx
	C305 umber		
	C011 cotton		C100 ice
	C107 mooncrest		C210 pitch
	C416 sapphire	Free pick: Other fabrics available upon request.	

UBJCP.2S-3S BASE

	S01 white		S02 silver
	S31 charcoal		

UBIGB-JCP.2S-3S in ground base
UBOGB-JCP.2S-3S on ground base

PROTECTION COVER

	UPJCP.2S-X77 black
--	--------------------

GUTTERS p. 90

UAJCP.2S colour of the canopy

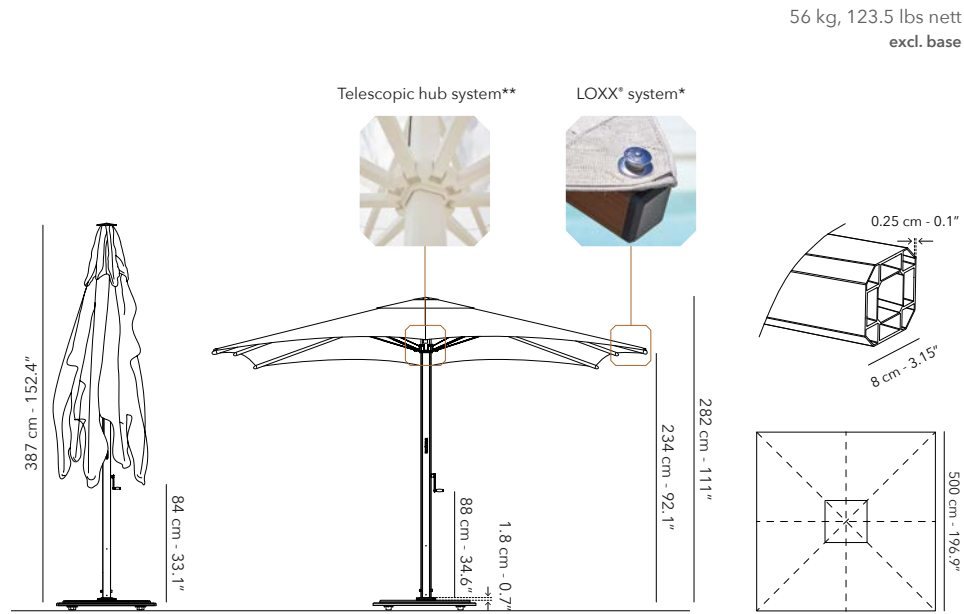

56 kg, 123.5 lbs nett
excl. base

All dimensions exclude the base.
* Stainless steel LOXX® to easily attach the canopy to the frame and detach it.
** Easy to open and close without touching furniture.

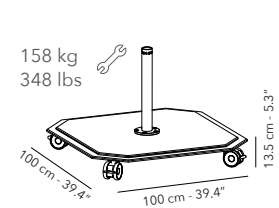

BASE

- Base with 4 wheels that rotate 360°, each with brakes to fix the umbrella.
- Has the same colour as its frame.

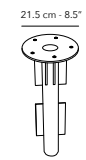

IN GROUND BASE

Anchored in the ground with concrete. Can not be moved.

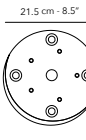

ON GROUND BASE

Only possible with a substrate where chemical anchoring is possible.

Ø 450 CM

UFJCP.203 FRAME

	A01 white		A02 silver
	A31 charcoal		

UCJCP.203 CANOPY

	C003 pearl		C011 cotton
	C100 ice		C107 mooncrest
	C207 onyx		C210 pitch
	C305 umber		C416 sapphire

Free pick: Other fabrics available upon request.

UBJCP.2S-3S BASE

	S01 white		S02 silver
	S31 charcoal		

UBIGB-JCP.2S-3S in ground base
UBOGB-JCP.2S-3S on ground base

PROTECTION COVER

	UPJCP.2S-X77 black
--	--------------------

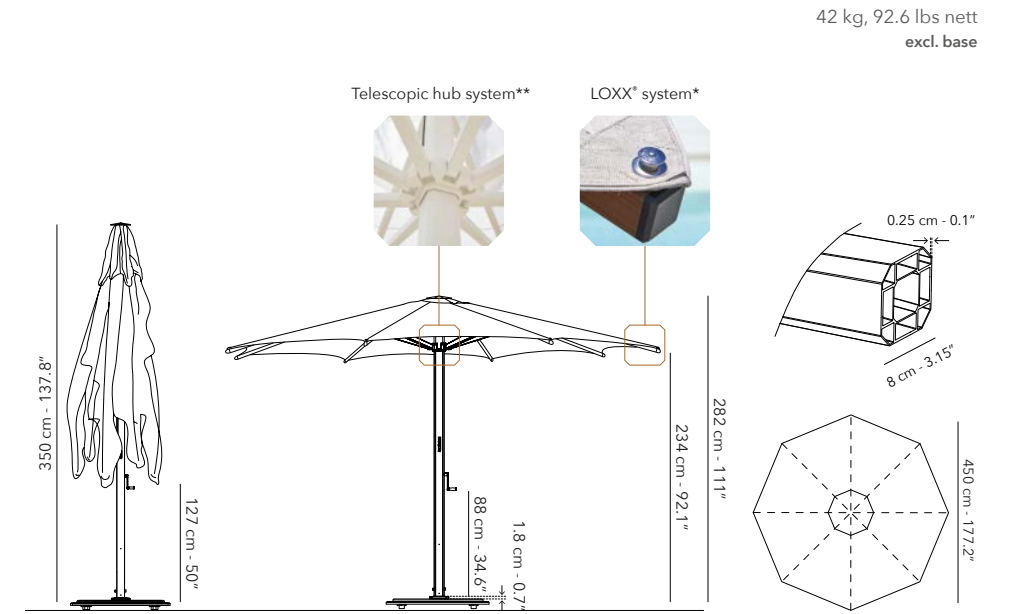

42 kg, 92.6 lbs nett
excl. base

All dimensions exclude the base.
* Stainless steel LOXX® to easily attach the canopy to the frame and detach it.
** Easy to open and close without touching furniture.

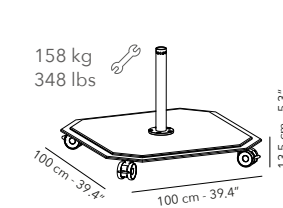

BASE

- Base with 4 wheels that rotate 360°, each with brakes to fix the umbrella.
- Has the same colour as its frame.

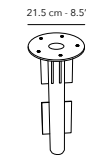

IN GROUND BASE

Anchored in the ground with concrete. Can not be moved.

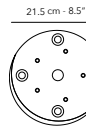

ON GROUND BASE

Only possible with a substrate where chemical anchoring is possible.



JCP.3 SERIES

- ✓ Full aluminium frame.
- ✓ Shade wherever you like, depending on the position of the sun.
- ✓ Put together according to your taste and preference.
- ✓ Ideal for both private use and hospitality projects.

FRAME Free pole umbrella with crank handle. Pole and ribs are aluminium powder coated. Pole profile: 80 x 80 x 2.3 mm, 3.5 x 3.5 x 0.09". Ribs profile: 22 x 22 x 1.6 mm, 0.9 x 0.9 x 0.06".

CANOPY 320g/m² Sunbrella® Plus, 100% solution dyed acrylic. Fast stock: canopies available from stock.

BASE 2 hot galvanised steel plates, powder coated.

TILT & ROTATION Tilt in height, left and right. Rotation of 360° by means of a pin at the bottom of the pole.

WIND SPEED 58 km/h, 36 mph - Maximum wind speed to which the umbrella may be exposed.



JCP.301 - 300 x 300 cm



JCP.302 - 260 x 260 cm



JCP.303 - ø 350 cm

JCP.301



42 kg, 92.6 lbs nett
excl. base

300 X 300 CM

UMJCP.301 FRAME & CANOPY

FIXED COMBO			A01C101 white & cloud
			A12C001 alu teal & natural
			A31C101 charcoal & cloud
			A31C204 charcoal & night
			A32C208 black & black

UFJCP.301 FRAME

	A01 white		A02 silver
	A10 cappuccino		A12 alu teal
	A31 charcoal		A32 black

UCJCP.301 CANOPY

	C003 pearl		C011 cotton
	C100 ice		C207 onyx
	C305 umbur		

C107 mooncrest

	C210 pitch
--	------------

Free pick: Other fabrics available upon request.

UBJCP.2S-3S BASE

	S01 white		S02 silver
	S31 charcoal		S32 black

UBIGB-JCP.2S-3S in ground base
UBOGB-JCP.2S-3S on ground base

PROTECTION COVER

	UPJCP.3S-X77 black
--	--------------------

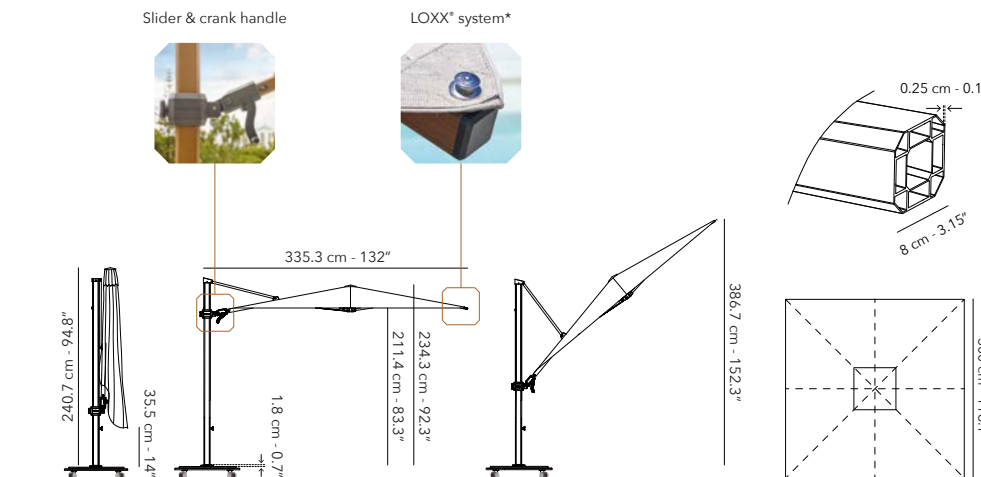

All dimensions exclude the base.
* Stainless steel LOXX® to easily attach the canopy to the frame and detach it.

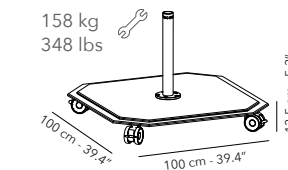

BASE

- Base with 4 wheels that rotate 360°, each with brakes to fix the umbrella.
- Has the same colour as its frame.
- For a frame in alu teal and cappuccino we provide a charcoal base.

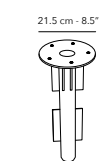

IN GROUND BASE

Anchored in the ground with concrete. Can not be moved.

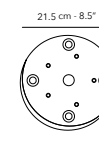

ON GROUND BASE

Only possible with a substrate where chemical anchoring is possible.

260 X 260 CM

UMJCP.302 FRAME & CANOPY

FIXED COMBO			A01C101 white & cloud
			A12C001 alu teak & natural
			A31C101 charcoal & cloud
			A31C204 charcoal & night

UFJCP.302 FRAME

	A01 white		A02 silver
	A10 cappuccino		A12 alu teak
	A31 charcoal		

UCJCP.302 CANOPY

MIX & MATCH		C003 pearl		C011 cotton
		C100 ice		C207 onyx
		C305 umber		
		C107 mooncrest		C210 pitch

	C107 mooncrest		C210 pitch
	C416 sapphire	Free pick: Other fabrics available upon request.	

UBJCP.2S-3S BASE

	S01 white		S02 silver
	S31 charcoal		

UBIGB-JCP.2S-3S in ground base
UBOGB-JCP.2S-3S on ground base

PROTECTION COVER

	UPJCP.3S-X77 black
--	--------------------

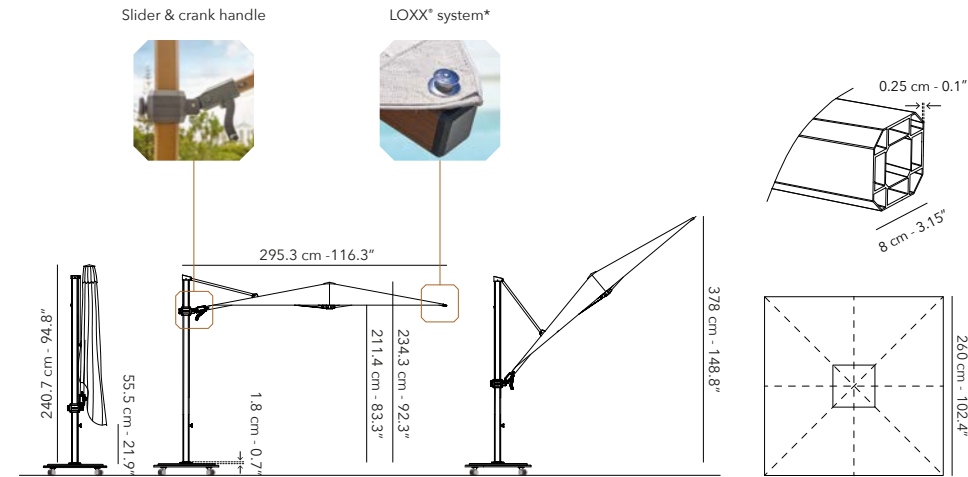

All dimensions exclude the base.
* Stainless steel LOXX® to easily attach the canopy to the frame and detach it..



31 kg, 68.3 lbs nett
excl. base

Ø 350 CM

UFJCP.303 FRAME

	A01 white		A02 silver
	A10 cappuccino		A12 alu teak
	A31 charcoal		

UCJCP.303 CANOPY

MIX & MATCH		C003 pearl		C011 cotton
		C100 ice		C107 mooncrest
		C207 onyx		C210 pitch
		C305 umber		C416 sapphire

UBJCP.2S-3S BASE

	S01 white		S02 silver
	S31 charcoal		

UBIGB-JCP.2S-3S in ground base
UBOGB-JCP.2S-3S on ground base

PROTECTION COVER

	UPJCP.3S-X77 black
--	--------------------

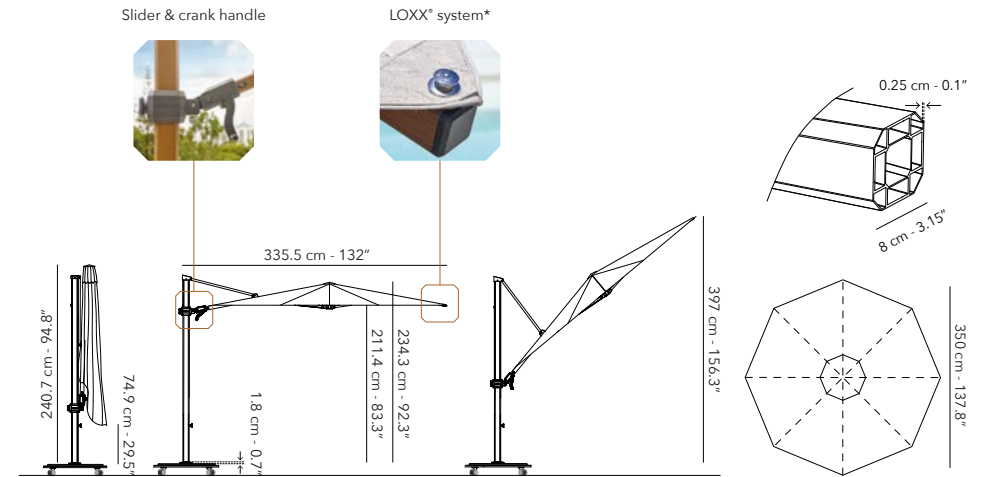

All dimensions exclude the base. - Toutes les dimensions excluent le socle.
* Stainless steel LOXX® to easily attach the canopy to the frame and detach it..



34 kg, 74.9 lbs nett
excl. base

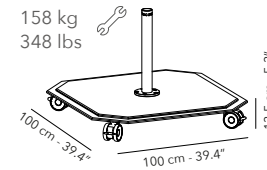

BASE

- Base with 4 wheels that rotate 360°, each with brakes to fix the umbrella.
- Has the same colour as its frame.
- For a frame in alu teak and cappuccino we provide a charcoal base.

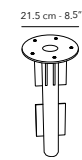

IN GROUND BASE

Anchored in the ground with concrete. Can not be moved.

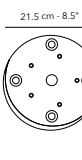

ON GROUND BASE

Only possible with a substrate where chemical anchoring is possible.

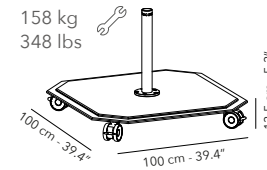

BASE

- Base with 4 wheels that rotate 360°, each with brakes to fix the umbrella.
- Has the same colour as its frame.
- For a frame in alu teak and cappuccino we provide a charcoal base.

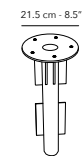

IN GROUND BASE

Anchored in the ground with concrete. Can not be moved.

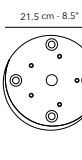

ON GROUND BASE

Only possible with a substrate where chemical anchoring is possible.

JCP.4 SERIES

- ✓ Full aluminium frame.
- ✓ Despite its weight of 309 kg (incl. base), an elegant appearance.
- ✓ Variations in dimensions, finishes and colours.
- ✓ Ideal for a lounge setting or over long dining tables.

FRAME	Free pole umbrella with crank handle. Pole and ribs are aluminium powder coated. Pole profile: 100 x 100 x 3.5 mm, 3.9 x 3.9 x 0.2". Ribs profile: 32 x 32 x 1.6 mm, 1.2 x 1.2 x 0.06".
CANOPY	320g/m ² Sunbrella® Plus, 100% solution dyed acrylic.  Fast stock: canopies available from stock.
BASE	3 hot galvanized steel plates, powder coated.
TILT & ROTATION	Tilt in height. Rotation of 360° by means of a pin at the bottom of the pole.
WIND SPEED	58 km/h, 36 mph - Maximum wind speed to which the umbrella may be exposed.

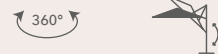

JCP.401 - 370 x 370 cm



JCP.402 - 425 x 300 cm



JCP.403 - ø 400 cm



JCP.404 - 250 x 350 cm

370 X 370 CM

UMJCP.401 FRAME & CANOPY

FIXED COMBO			A01C101 white & cloud
			A12C001 alu teak & natural
			A31C101 charcoal & cloud
			A31C204 charcoal & night
			A32C208 black & black

UFJCP.401 FRAME

	A01 white		A02 silver
	A10 cappuccino		A12 alu teak
	A31 charcoal		A32 black

UCJCP.401 CANOPY

MIX & MATCH		C003 pearl		C011 cotton
		C100 ice		C207 onyx
		C305 umber		
		C107 mooncrest		C210 pitch
		C416 sapphire	Free pick: Other fabrics available upon request.	

UBJCP.4S BASE

	S01 white		S02 silver
	S31 charcoal		S32 black

UBIGB-JCP.4S-5S-6S in ground base
UBOGB-JCP.4S-5S-6S on ground base

PROTECTION COVER

	UPJCP.4S-X77 black
--	--------------------

JCP.401



64 kg, 141.1 lbs nett
excl. base

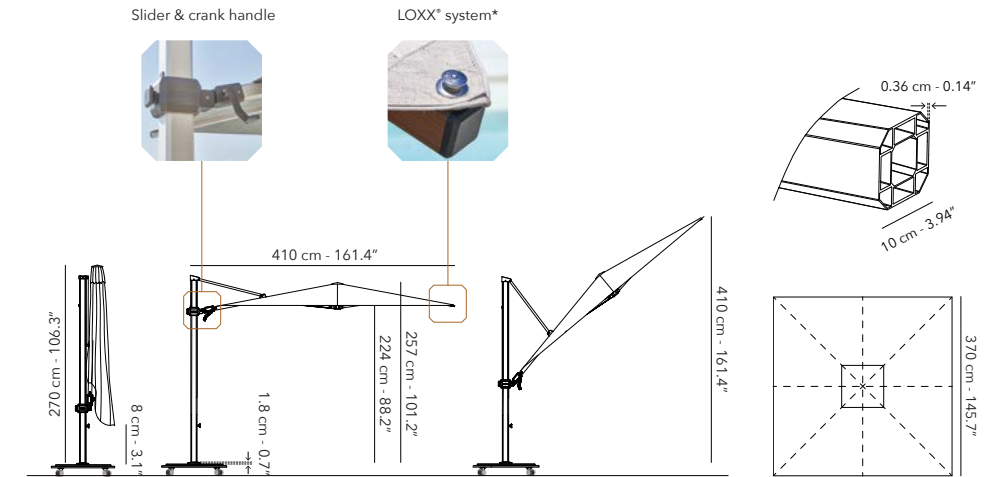

All dimensions exclude the base.

* Stainless steel LOXX® to easily attach the canopy to the frame and detach it.

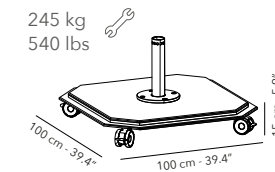

BASE

- Base with 4 wheels that rotate 360°, each with brakes to fix the umbrella.
- Has the same colour as its frame. For a frame in alu teak and cappuccino we provide a charcoal base.

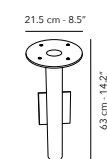

IN GROUND BASE

Anchored in the ground with concrete. Can not be moved.

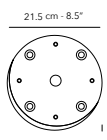





ON GROUND BASE

Only possible with a substrate where chemical anchoring is possible.

425 X 300 CM

UFJCP.402 FRAME

 A01 white	 A02 silver
 A10 cappuccino	 A12 alu teak
 A31 charcoal	

MIX & MATCH UCJCP.402 CANOPY

 C003 pearl	 C011 cotton
 C100 ice	 C207 onyx
 C305 umber	
 C107 mooncrest	 C210 pitch
 C416 sapphire	Free pick: Other fabrics available upon request.

UBJCP.4S BASE

 S01 white	 S02 silver
 S31 charcoal	

UBIGB-JCP.4S-5S-6S in ground base
UBOGB-JCP.4S-5S-6S on ground base

PROTECTION COVER

 UPJCP.4S-X77 black
--

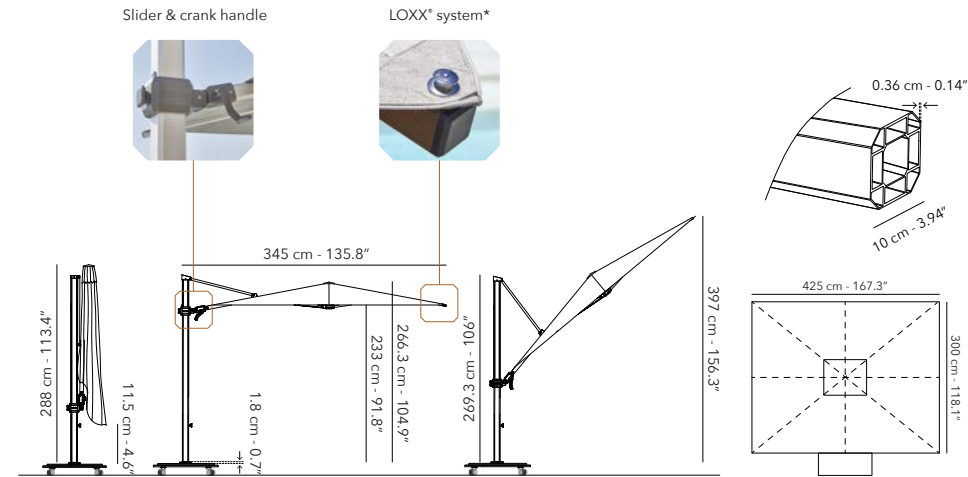

53 kg, 116.8 lbs nett
excl. base

All dimensions exclude the base.
* Stainless steel LOXX® to easily attach the canopy to the frame and detach it.

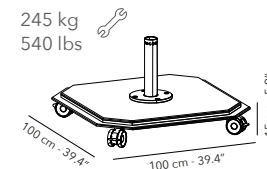

BASE

- Base with 4 wheels that rotate 360°, each with brakes to fix the umbrella.
- Has the same colour as its frame.
- For a frame in alu teak and cappuccino we provide a charcoal base.

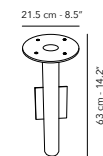

IN GROUND BASE

Anchored in the ground with concrete. Can not be moved.

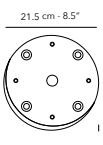

ON GROUND BASE









Only possible with a substrate where chemical anchoring is possible.

Ø 400 CM

UFJCP.403 FRAME

 A01 white	 A02 silver
 A10 cappuccino	 A12 alu teak
 A31 charcoal	

MIX & MATCH UCJCP.403 CANOPY

 C003 pearl	 C011 cotton
 C100 ice	 C107 mooncrest
 C207 onyx	 C210 pitch
 C305 umber	 C416 sapphire

Free pick: Other fabrics available upon request.

UBJCP.4S BASE

 S01 white	 S02 silver
 S31 charcoal	

UBIGB-JCP.4S-5S-6S in ground base
UBOGB-JCP.4S-5S-6S on ground base

PROTECTION COVER

 UPJCP.4S-X77 black
--

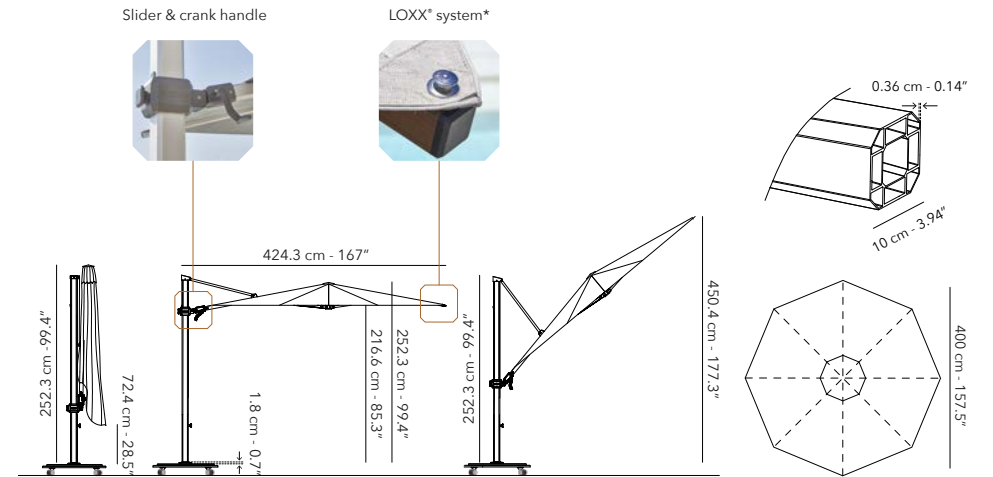

53 kg, 116.8 lbs nett
excl. base

All dimensions exclude the base.
* Stainless steel LOXX® to easily attach the canopy to the frame and detach it.

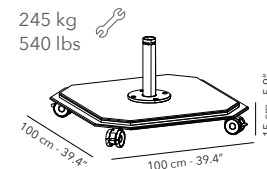

BASE

- Base with 4 wheels that rotate 360°, each with brakes to fix the umbrella.
- Has the same colour as its frame.
- For a frame in alu teak and cappuccino we provide a charcoal base.

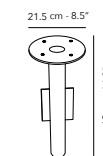

IN GROUND BASE

Anchored in the ground with concrete. Can not be moved.

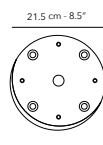

ON GROUND BASE

Only possible with a substrate where chemical anchoring is possible.

JCP.404

250 X 350 CM

UFJCP.404 FRAME



 A01 white	 A02 silver
 A10 cappuccino	 A12 alu teak
 A31 charcoal	

MIX & MATCH

UCJCP.404 CANOPY

 C003 pearl	 C011 cotton
 C207 onyx	
 C100 ice	 C107 mooncrest
 C210 pitch	 C305 umber
 C416 sapphire	Free pick: Other fabrics available upon request.

UBJCP.4S BASE - SOCLE

 S01 white	 S02 silver
 S31 charcoal	

UBIGB-JCP.4S-5S-6S in ground base
UBOGB-JCP.4S-5S-6S on ground base

PROTECTION COVER

 UPJCP.4S-X77 black



60 kg, 132.3 lbs nett
excl. base

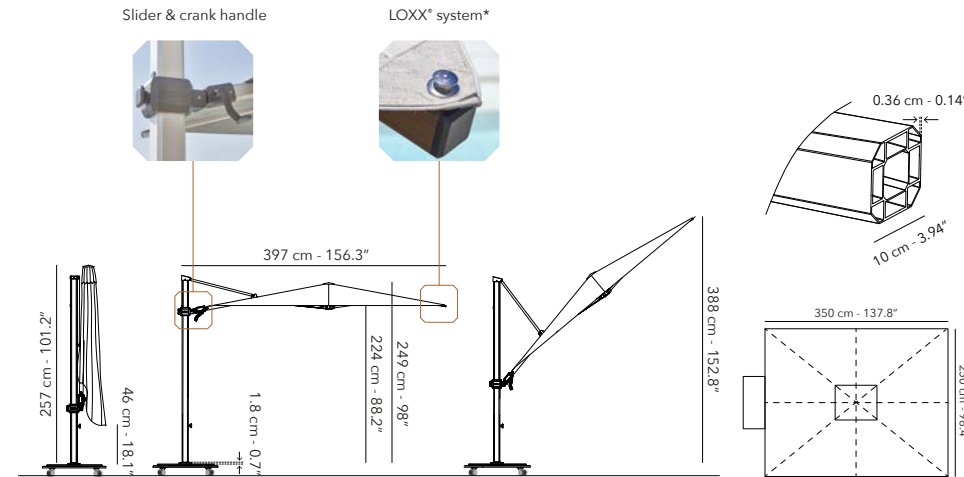

All dimensions exclude the base.
* Stainless steel LOXX® to easily attach the canopy to the frame and detach it.

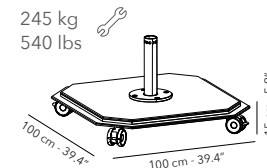

BASE

- Base with 4 wheels that rotate 360°, each with brakes to fix the umbrella.
- Has the same colour as its frame. For a frame in alu teak and cappuccino we provide a charcoal base.

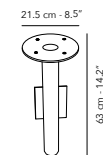

IN GROUND BASE

Anchored in the ground with concrete. Can not be moved.

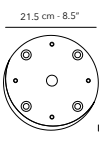

ON GROUND BASE

Only possible with a substrate where chemical anchoring is possible.



JCP.403 ø 400 cm A31 charcoal C207 onyx



JCP.5 SERIES

- ✓ Full aluminium frame.
- ✓ 4 free pole umbrellas on one mid pole.
- ✓ Heavy 300 kg steel base or in ground base.
- ✓ Ideal for hospitality projects.

FRAME	4 free pole umbrellas with crank handle. Pole and ribs are aluminium powder coated. Pole profile: 150 x 150 x 3.6 mm, 5,9 x 5,9 x 0.14". Ribs profile: 32 x 32 x 2.5 mm, 1.2 x 1.2 x 0.1".
CANOPY	320g/m ² Sunbrella® Plus, 100% solution dyed acrylic. 🕒 Fast stock: canopies available from stock.
BASE	3 hot galvanised steel plates, powder coated.
TILT	Tilt in height.
WIND SPEED	58 km/h, 36 mph - Maximum wind speed to which the umbrella may be exposed.



JCP.501 - 4* 300 x 300 cm

JCP.501



143.5 kg, 316.4 lbs nett
excl. base

4* 300 X 300 CM

UFJCP.501 FRAME

	A02 silver		A12 alu teak
	A31 charcoal		

MIX & MATCH

UCJCP.501 CANOPY

	C003 pearl		C011 cotton
	C207 onyx		
	C100 ice		C107 mooncrest
	C210 pitch		C305 umber
	C416 sapphire	Free pick: Other fabrics available upon request.	

UBJCP.5S-6S BASE

	S02 silver		S31 charcoal
--	------------	--	--------------

UBIGB-JCP.4S-5S-6S in ground base
UBOGB-JCP.4S-5S-6S on ground base

PROTECTION COVER

	UPJCP.5S-X77 black
--	--------------------

UAJCP.5S - GUTTERS (4x) p. 90

A fabric from our fast stock

Other fabric of your choice

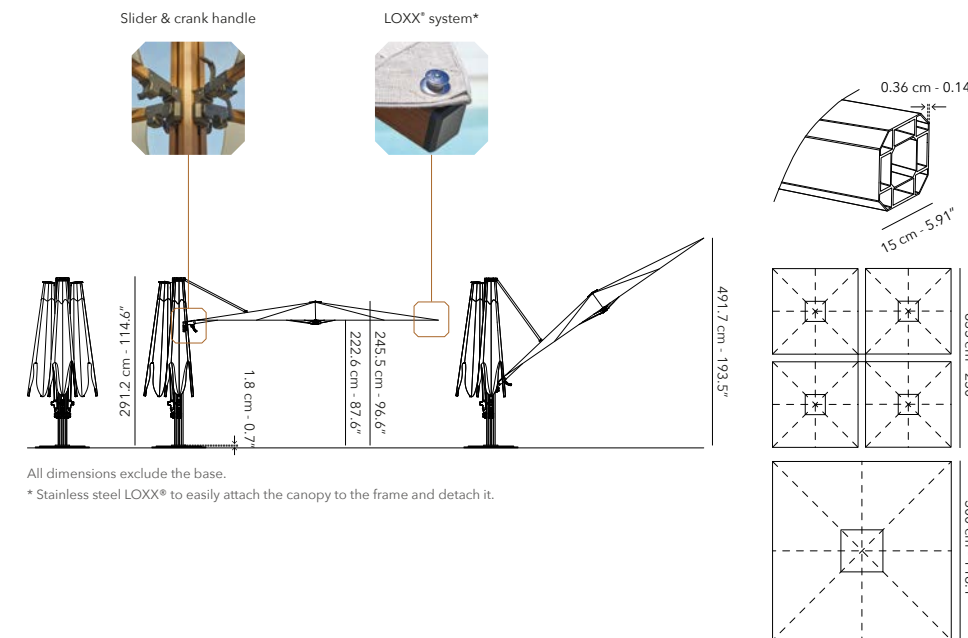

All dimensions exclude the base.
* Stainless steel LOXX* to easily attach the canopy to the frame and detach it.

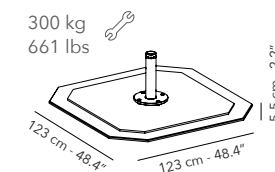

- BASE**
- Base without wheels.
 - Has the same colour as its frame.
 - For a frame in alu teak we provide a charcoal base.

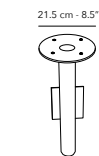

IN GROUND BASE

Anchored in the ground with concrete.
Can not be moved.

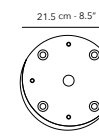

ON GROUND BASE

Only possible with a substrate where chemical anchoring is possible.

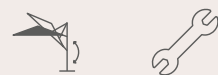



JCP.6 SERIES

- ✓ Full aluminium frame.
- ✓ 2 free pole umbrellas on one mid pole.
- ✓ Heavy 300 kg steel base or in ground base.
- ✓ Ideal for hospitality projects.

FRAME	2 free pole umbrellas with crank handle. Pole and ribs are aluminium powder coated. Pole profile: 150 x 150 x 3.6 mm, 5.9 x 5.9 x 0.14". Ribs profile: 32 x 32 x 2.5 mm, 1.2 x 1.2 x 0.1".
CANOPY	320g/m ² Sunbrella® Plus, 100% solution dyed acrylic. 🕒 Fast stock: canopies available on stock.
BASE	Hot galvanized steel plate, powder coated.
TILT	Tilt in height.
WIND SPEED	58 km/h, 36 mph - Maximum wind speed to which the umbrella may be exposed.



JCP.601 - 2* 300 x 300 cm

JCP.601



86.5 kg, 190.7 lbs nett
excl. base

2* 300 X 300 CM

UFJCP.601 FRAME

	A10 cappuccino		A12 alu teak
	A31 charcoal		

MIX & MATCH

UCJCP.601 CANOPY

	C003 pearl		C011 cotton
	C207 onyx		
	C100 ice		C107 mooncrest
	C210 pitch		C305 umber
	C416 sapphire		

UBJCP.5S-6S BASE

	S31 charcoal
--	--------------

UBIGB-JCP.4S-5S-6S in ground base
UBOGB-JCP.4S-5S-6S on ground base

PROTECTION COVER

	UPJCP.6S-X77 black
--	--------------------

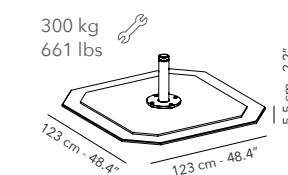
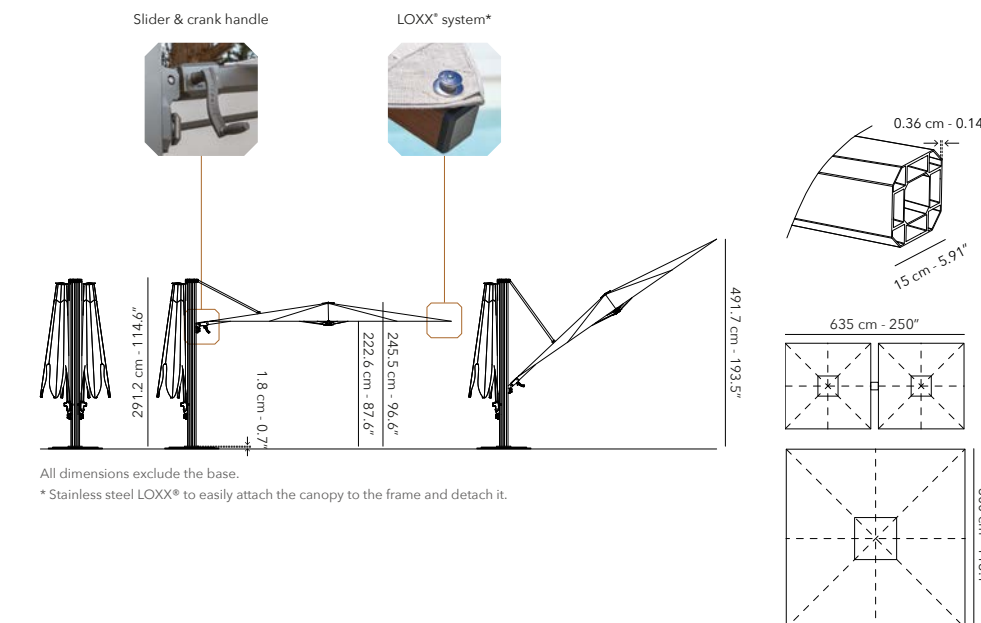

- BASE**
- Base without wheels.
 - Has the same colour as its frame.
 - For a frame in alu teak we provide a charcoal base.

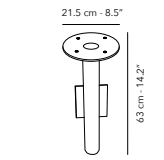

IN GROUND BASE
Anchored in the ground with concrete.
Can not be moved.

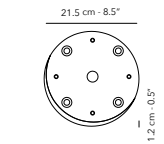

ON GROUND BASE
Only possible with a substrate where chemical anchoring is possible.

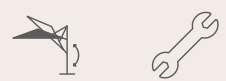



Material SPECIFICATIONS

Our materials are always selected in function of intensive outdoor use and exposure to the sun. Jardinico only works with the best materials to ensure the best quality, added value and a luxurious appearance in any environment around the globe. Quality, aesthetics and durability are absolute top priorities. The best materials embrace Caractère's beautiful design for you to enjoy the outdoors carefree for many years to come.



All fabrics for the outdoor umbrellas canopies from the Caractère collection are from Sunbrella® PLUS Marine collection and made of solution dyed acrylic yarns. A global reference for marine applications, 100% recyclable and ideal for sun, wind and rain protection.











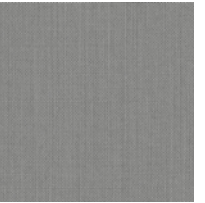

Performance

All canopies are made of solutions dyed acrylic. This means the colour of the fabric runs all the way through the yarn. The colour is added to the liquid solution that the yarn is extruded from. Only solution dyed fabrics keep their colour and are resistant to fading under the effect of UV rays when exposed to the sun.

Stain resistant & waterproof

All fabrics have a surface finish that makes the fabric water and stain repellent. A coating on the reverse side makes the fabric waterproof, mildew resistant and keeps its drying time to a minimum. Please consult our product data sheets or website to learn more on how to care and maintain your fabrics.

FABRICS

							
C003 pearl	C011 cotton	C100 ice	C107 mooncrest	C207 onyx	C210 pitch	C305 umber	C416 sapphire
 JCP.1, 2, 3, 4, 5, 6 series	 JCP.1, 2, 3, 4, 5, 6 series	 JCP.1, 3, 4 series		 JCP.1, 2, 3, 4, 5, 6 series		 JCP.1, 2, 3, 4 series	

Technical data

Composition	100% solution dyed acrylic from Sunbrella® PLUS Marine collection
Finish	Resin based anti-fungi coating, water and UV resistant
Weight	320 g/m ²
UPF 50+	The fabric filters more than 98% of UVB rays
Colour fastness UV ISO 105 B02	UV ISO 105 B02: 7-8 / 8 dry & wet friction: 5 / 5

Fast stock

Canopies available from stock. We offer 'fast stock' to speed up the delivery time of our canopies. We selected a few fabrics of which canopies are held in stock in Belgium and can be delivered quickly. This service is subject to availability of raw materials worldwide. These colours are shown above with the following icon: 

It is always possible to order canopies that differ from the fast stock colours. A delivery time of six to eight weeks should be taken into account. An overview of all available fabrics can be found above.





MATERIALS

POWDER COATED ALUMINIUM

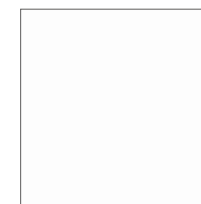

A01
white



A02
silver



A10
cappuccino

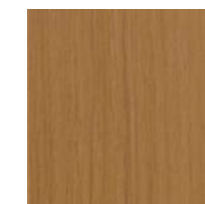

A12
alu teak



A31
charcoal



A32
black

STAINLESS POWDER COATED STEEL

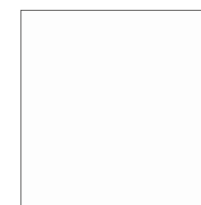

S01
white



S02
silver



S31
charcoal



S32
black

Aluminium treated with a structured coloured coating.

Epoxy powder coating to increase durability and strength. It makes the material water repellent, stain and scratch resistant.

Excellent resistance to corrosion under the effect of various weather conditions due to the technique also used in marine applications.

Suitable for outdoor use. Easy to clean and maintain.

Hot galvanised steel plates treated with a structured coloured coating.

Structured powder coating to increase durability and strength. It makes the material water repellent, stain and scratch resistant.

Stainless steel with excellent resistance to corrosion under the effect of various weather conditions due to the technique also used in marine applications.

Suitable for outdoor use. Easy to clean and maintain.



Protection & MAINTENANCE

To enhance the durability and appearance of your outdoor umbrella, we recommend following our care instructions regularly. The umbrella should never be used in strong wind or rainy conditions. An open umbrella should never be left unattended. The umbrella should be protected against blurring or damage by always using its accompanying protection cover. During autumn and winter, we advise to store the umbrella in a dry place when not in use.

PROTECTION

PROTECTION COVER

We suggest to always use the protection cover to protect your outdoor umbrella from poor weather conditions or when not in use during the summer. The protection cover can be placed over the umbrella and its pole. The stain resistant and water repellent cover will extend its life for you to enjoy your umbrella whenever you like.

Ref.	Colour	Swatch	Weight	About this fabric
X77	Black		240 g/m ²	Sunbrella® surlast black, 100% solution dyed acrylic with PU coating



GUTTERS

Gutters provide uninterrupted protection between multiple outdoor umbrellas. Connecting umbrellas enables large areas to have complete coverage from the sun or rainy weather conditions.

A gutter is always attached to the umbrella at a slight decline to allow water to drain off efficiently in desired directions.

Our gutters are only applicable on the following umbrellas:

- JCP.201 (p. 65)
- JCP.202 (p. 66)
- JCP.501 (p. 79)

They are available in the same colour as your umbrella canopy to blend in perfectly.



MAINTENANCE

FRAME & BASE

Clean the aluminium frame with a damp cloth, mild soap and water. Do not use any sharp tool to avoid scratches.

CANOPY







Before use, you can apply an invisible film to make the canopy stain and water repellent by using a textile protector. You can maintain and clean your canopy by following a few simple steps:

- Brush off loose dirt before it becomes embedded in the fabric.
- Hose down.
- Spot clean soon after stains occur with water and mild soap or a textile cleaner (no detergents). Use a soft bristle brush to clean.
- Allow soap to soak in.
- Rinse thoroughly.
- Always let the canopy air dry completely before storing or covering.

Machine wash in cold water. Depending on wash load size, use normal amounts of mild laundry detergent and add 1 cup of bleach. Allow fabric to air dry. Never subject to excessive heat, steam press or tumble dry as the fabric will shrink.



CORRECTOR PEN 12 ML

	SPCOR-12ML		A01 white
			A03 linen
			A11 taupe
			A30 anthracite
			A31 charcoal
			A32 black

Quick-drying liquid paint with built-in brush for powder-coated surfaces. Ideal for retouching small surface traces (scratches, wear).

MAINTENANCE SET

	SPCARE-TEXT-75CL	2 scrubbing sets 3 application cloths 1 textile protector 750 ml 1 textile cleaner 750 ml
---	-------------------------	--

Project

REFERENCES

Fairmont Royal palm - Marrakesh - Morocco

Sea lounge - Porto-Vecchio - Corsica

Cove beach - Dubai - UAE

Limonade Maillot - Paris - France

Kempinski - Aqaba - Jordan

Jules Bar - Kortrijk - Belgium

Radisson Blu - Wiesbaden - Germany

Limonade Maillot - Paris - France

Wittamer - Brussels - Belgium

Kempinski Hotel - Bruges - Belgium

Blue Origin - Deerlijk - Belgium

Blue Buddha Beachclub - Knokke - Belgium

Collin's Beach - Knokke - Belgium

Bar d'O Beach Club - Knokke - Belgium

Blue Buddha beach club - Knokke - Belgium

Kruisheren Hotel - Maastricht - The Netherlands

Country Club - Samois Sur Seine - France

Le Couvent des Minimes - Mane - France

Hôtel Julien - Fouday - France

Peninsula - Paris - France

Golf Up - Grimaud - France

Nørgaard - Hornbaek - Denmark

La Plage - Casadelmar - Corsica

Yacht Club - Porto-Montenegro

La Gazelle d'Or - Tunesia

Parkhotel - Kortrijk - Belgium

Eyebar - Hong Kong - China

Honi Honi Bar - Hong Kong - China

Wooloo Mooloo - Hong Kong - China

Retreat & Spa - Maledives

Berjaya Hotel - Kuala Lumpur - Malaysia

Mulia Hotel - Bali - Indonesia

Age-Hassim Hill - Singapore

Joe's Café - Doha - Qatar

Utopia - Abu Dhabi

Mercure Hotel Harbourside - Carens - Australia

Royalton Hotel Riviera Cancun - Mexico

Grand Palladium Lady Hamilton - Jamaica

Radisson Blu - Dakar - Senegal

Catalogue made thanks to:

- Jardinico® team
- Shoot Photography
- Steije.be Creative Video Agency
- Frederik Naessens Transport

JARDINICO PARASOLS BV
Evolis 101
8530 Harelbeke
Belgium

T +32 (0)56 89 04 10

info@jardinico.com
www.jardinico.com

Follow us on:



Visit our website
to learn more:



www.jardinico.com