

2025



FINEST ITALIAN SHADE

SCOLARO PARASOL

*GALAXIA
CATALOGUE*

GALAXIA CATALOGUE



GALAXIA

Abbiamo ideato un nuovo futuro per vivere lo spazio esterno dominato da sinergia tra:
Tecnologia | Ergonomia | Design | Innovazione

La sapienza e l'eccellenza italiana artigiana si sono evolute e raffinate attraverso studi accurati e dedicati, tecnologici e di ingegneria, ottenendo risultati stratosferici: GALAXIA

We have created a futuristic way of living the outdoors through the synergic combination of:
Technology | Ergonomics | Design | Innovation
 Italian wisdom and artisanal excellence have evolved and been refined through dedicated technological and engineering studies, producing stratospheric results: GALAXIA.

Futuristisch innovative Art im Freien zu leben Synergie zwischen: **Technologie | Ergonomie | Design | Innovation**
 Die Weisheit und die handwerkliche italienische Exzellenz haben sich weiterentwickelt und verfeinert durch genaue, relevante, technologische und technische Forschungen. Es wurden stratosphaerische Ergebnisse erzielt: GALAXIA.

Nous avons créé un nouveau produit reposant sur un nouveau concept, la synergie entre:
Technologie | Ergonomie | Conception | Innovation
 L'excellence et le raffinement de l'artisanat italien ont évolué grâce à des études précises et des avancées technologiques de l'ingénierie, permettant d'obtenir des résultats exceptionnels: GALAXIA.

Hemos ideado un nuevo futuro para vivir el espacio exterior en sinergia dominado entre:
Tecnología | Ergonomía | Diseo | Innovación
 La sabiduría y la excelencia italiana artesana se han evolucionado y perfeccionado a través de estudios cuidadosos y dedicados, tecnológicos y de ingeniería, obteniendo resultados estratosféricos: GALAXIA.

INTRODUZIONE INTRODUCTION

IT

Scolaro è un'azienda nata 50 anni fa come antico laboratorio artigianale di ombrelloni DOC e trae le sue radici nelle vicinanze di Venezia, luogo intriso di storia e bellezza senza tempo, che ha ispirato generazioni di artisti. L'ampia gamma di articoli è studiata per il Contract, l'arredo giardino e il settore pubblicitario ed è costituita da ombrelloni in legno e alluminio con palo centrale, palo laterale e con telaio telescopico. La politica aziendale costantemente rivolta alla soddisfazione del cliente finale consente ora a Scolaro di esportare i propri prodotti in più di 70 Paesi, ottenendo il riconoscimento di azienda ambasciatrice del made in Italy.

All'esperienza e capacità manipolativa aggiunge negli anni sempre maggiori tecnologie per migliorare lo standard qualitativo e da semplice prodotto per riparare dal sole ne ha fatto un elegante strumento per l'arredamento personalizzato. Il design, le nuove soluzioni tecniche e l'abbinamento dei materiali migliori, segnano l'evoluzione e l'utilizzo dell'ombrellone, il tutto garantito da un processo produttivo interamente italiano. I nostri articoli sono progettati, sviluppati e prodotti interamente all'interno della nostra azienda con sede in Italia. Particolare cura per la rifinitura e il controllo di qualità sono parte integrante della nostra politica.

Grazie ai materiali impiegati e ai dispositivi tecnici i nostri articoli sono particolarmente robusti e adatti per un uso intenso e professionale. L'utilizzo di tessuti acrilici impermeabili, di legno, acciaio e alluminio trattati ne garantiscono una lunga vita. L'azienda Scolaro presta particolare attenzione alla facilità di manutenzione e alla disponibilità di componenti di ricambio garantita nel tempo.



43 PRODUCT RANGES
1000+ VARIANTS
+70 COUNTRIES
>7000^{M2} PRODUCTION FACILITY

EN

Scolaro is a company born 50 years ago as an ancient workshop of DOC umbrellas and draws its roots in the vicinity of Venice, a place steeped in history and timeless beauty, which has inspired generations of artists. The wide range of items is designed for contract, garden furniture and advertising sector, consists of wooden and aluminum umbrellas with central and side pole and telescopic frame. The company policy constantly aimed at final customer satisfaction allows Scolaro to export its products to more than 70 countries. To the experience and manipulative skills are added over the years more and more technologies to improve the quality standard, making a simple product for sheltering from the sun an elegant tool for personalized furnishing. Design, new technical solutions and the combination of the best materials mark the evolution and use of the sunshade, all guaranteed by an entirely Italian production process. Our products are designed, developed and produced entirely in-house by our company based in Italy. Special care for finishing and quality control are an imperative part of our policy. Thanks to the materials used and the technical devices, our products are particularly robust and suitable for intensive and professional use. The application of waterproof acrylic fabrics, treated wood, steel and aluminum ensure their long life. Scolaro Company pays special attention to ease of maintenance and the readiness of spare parts guaranteed over time.

ARCHITETTURA DEL FUTURO: RIPROGETTARE GLI SPAZI OUTDOOR

ARCHITECTURE OF THE FUTURE: REDESIGNING OUTDOOR SPACES

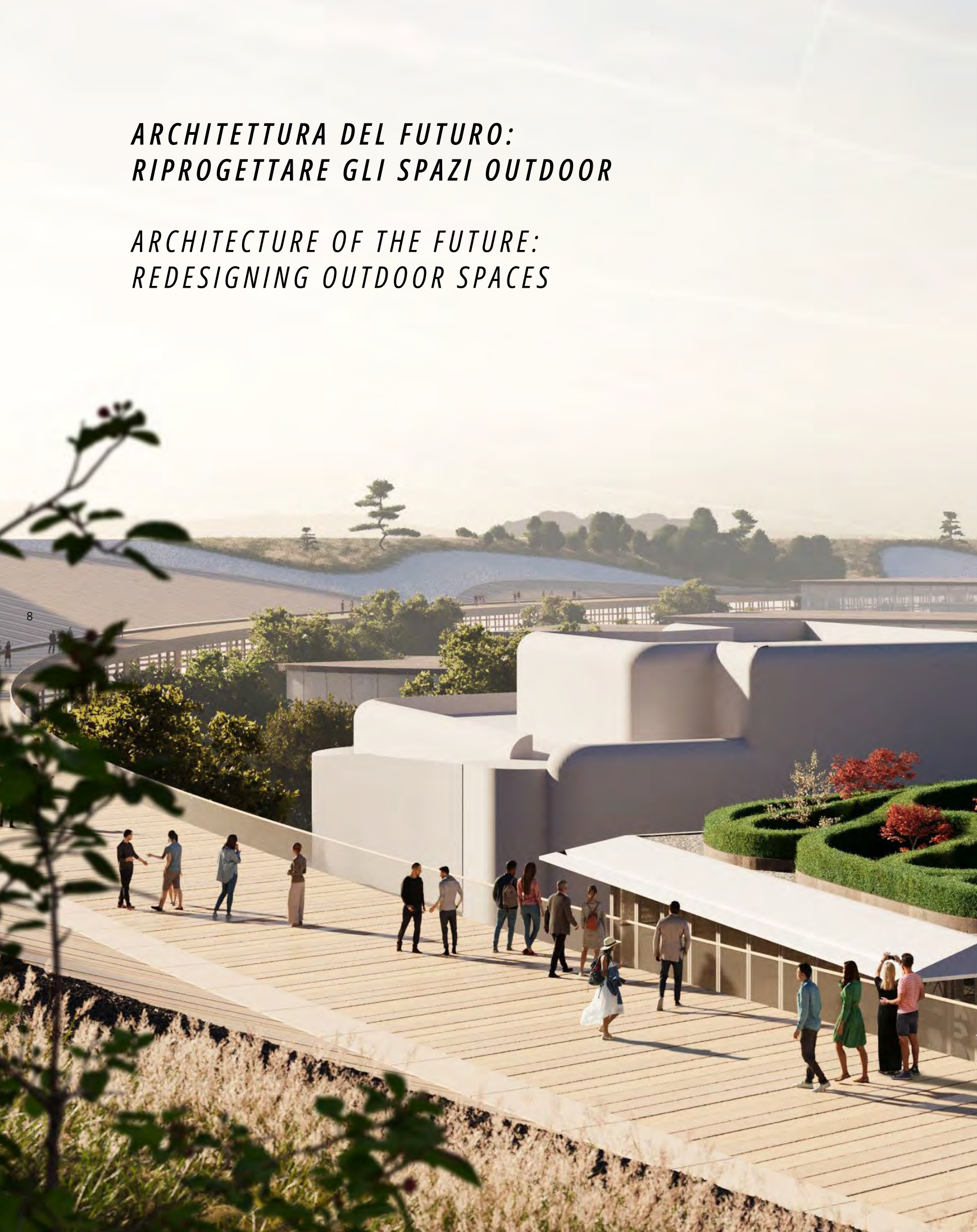

OFFICIAL PARTICIPANT

IT

L'Expo 2025 di Osaka rappresenta un traguardo di eccezionale importanza per la nostra azienda, posizionandoci come protagonisti del design outdoor a livello globale. I nostri prodotti avranno una visibilità straordinaria, accompagnando e accogliendo i visitatori negli spazi esterni comuni dell'esposizione, che è attesa per ospitare circa 30 milioni di visitatori da tutto il mondo. Questo palcoscenico internazionale ci offre l'opportunità di mostrare la qualità e l'innovazione che definiscono la nostra proposta di ombrelloni, consentendoci di costruire una connessione diretta con un pubblico internazionale ampio e diversificato. In aggiunta, abbiamo concluso l'accordo come sponsor tecnico del Padiglione Italia, un progetto che mira a rivisitare in chiave moderna la città ideale rinascimentale, completa di teatro, piazza e giardino all'italiana. Questo contesto ci offre una cornice perfetta per esprimere l'eleganza del nostro design e la raffinatezza della nostra produzione, e siamo orgogliosi che i nostri ombrelloni siano stati selezionati per rappresentare l'eccellenza italiana nel settore outdoor. Il Padiglione Italia, con la sua iconica bellezza e richiamo all'arte e alla cultura italiane, offrirà una vetrina unica per il nostro marchio, permettendoci di consolidare il legame tra tradizione e innovazione, tra estetica e funzionalità, valori che guidano ogni nostra creazione. Questa collaborazione all'Expo 2025 non solo esprime l'impegno dell'azienda verso la qualità e il prestigio del made in Italy, ma rafforza anche la nostra missione di diffondere l'arte del vivere all'aperto in ogni angolo del mondo.

EN

Expo 2025 in Osaka represents an exceptionally important milestone for our company, positioning us as a global player in outdoor design. Our products will have extraordinary visibility, accompanying and welcoming visitors in the common outdoor spaces of the exhibition, which is expected to host around 30 million visitors from all over the world. This international stage gives us the opportunity to showcase the quality and innovation that define our umbrella proposal, allowing us to build a direct connection with a large and different international audience. In addition, we have concluded an agreement as technical sponsor of the Padiglione Italia, a project that aims to revisit the ideal renaissance city in a modern key with theatre, square and Italian-style garden. This context offers us a perfect setting to express the elegance of our design and the sophistication of our production, we are proud that our umbrellas have been selected to represent Italian excellence in the outdoor industry. The Italy Pavilion, with its iconic beauty and references to Italian art and culture, will provide an unique showcase for our brand, allowing us to consolidate the connection between tradition and innovation, between aesthetics and functionality, values that guide all our creations. This partnership with Expo 2025 not only expresses the company's commitment to the quality and prestige of Made in Italy, but also reinforces our mission to spread the art of outdoor living to every corner of the world.

* Visual by MCA Visual - Courtesy of Commissioner General for Italy at Expo 2025 Osaka | www.italyexpo2025osaka.it

SISTEMA "MOTION"

Alla base del funzionamento innovativo c'è il Sistema Motion, che evolve il concetto di apertura e chiusura retrattile dell'ombrellone. In questa applicazione innovativa i bracci a forbice azionano direttamente le corone centrali per l'apertura e la chiusura.

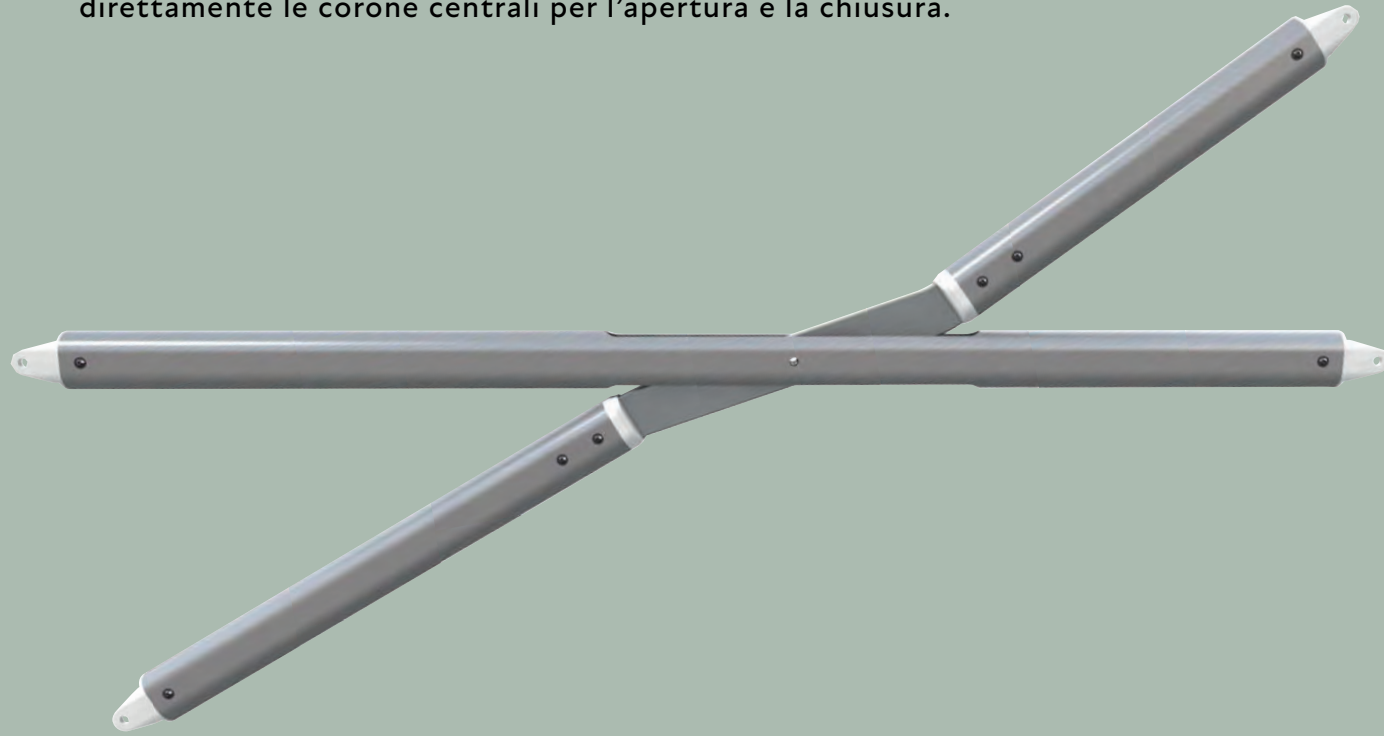

LIFT ACTION

La principale innovazione è l'applicazione di una molla a gas che agisce sul sistema MOTION assistendo l'apertura e riducendo al minimo lo sforzo in fase di apertura e chiusura dell'ombrellone



EN

LIFT ACTION

The main innovation is in the hydraulic gas strut which activates the MOTION system, assisting the mechanical operation and minimizing the effort required to open and close the umbrella.

DE

LIFT ACTION

Die wichtigste Neuerung ist die Anwendung einer Gasdruckfeder, die auf das System Motion wirkt und eine mühelose Öffnung und Schließung des Schirmes ermöglicht.

FR

LIFT ACTION

La principale innovation est la présence d'un ressort à gaz agissant sur le fonctionnement du parasol en facilitant l'ouverture et en réduisant l'effort d'ouverture et de fermeture du parasol.

ES

LIFT ACTION

La principal innovación es la aplicación de un muelle de gas que actúa sobre el sistema de movimiento por ayudar a la apertura y reducir al mínimo el esfuerzo en la apertura y cierre del parasol.

EN

SYSTEM "MOTION"

The revolutionary MOTION system allows the umbrella to open and retract in one motion. The innovative scissor arms activate the central crowns which in turn open and close the umbrella.

DE

SYSTEM "MOTION"

An der Basis des innovativen Betriebs befindet sich das System Motion, das das Konzept der Öffnung und Schließung des einziehbaren Schirmes entwickelt. In dieser innovativen Anwendung setzen die scherenförmige Arme direkt die zentralen Kronen zum Öffnen und Schließen in Bewegung.

FR

SYSTEM "MOTION"

A la base de l'opération novatrice il y a le système Motion, qui évolue le concept d'ouverture et de fermeture du parasol rétractable. Dans cette innovante les bras à ciseaux operant directement sur les couronnes centrales pour l'ouverture et la fermeture.

ES

SISTEMA "MOTION"

A la base de la operación innovadora está el sistema de movimiento, que evoluciona el concepto de abrir y cerrar el parasol retráctil. En esta aplicación innovadora, los brazos de tijeras conducen directamente las coronas centrales por apertura y cierre.



ERGONOMY DESIGN

Non solo tecnologia e funzionalità, ma anche ergonomia nei movimenti. Il design e il gusto italiano incidono sapientemente e rendono questo ombrellone unico in ogni singola linea trasmettendo sensazioni di equilibrio nelle forme.



EN

ERGONOMY DESIGN

Technology, functionality and ergonomic movements. Italian design and style make this umbrella unique, giving a sense of balance to its modern shape.

FR

ERGONOMY DESIGN

Non seulement la technologie et la fonctionnalité, mais aussi l'ergonomie du mouvement. La conception et l'influence de style italien à bon escient et de faire ce parasol unique dans chaque ligne, transmettant des sentiments d'équilibre dans les formes.

DE

ERGONOMY DESIGN

Nicht nur Technik und Funktionalität, sondern auch Ergonomie der Bewegung. Das Design und das italienische Design haben einen grossen Einfluss und machen aus diesem Schirm ein einzigartiges Produkt. Jede einzelne Linie uebermittelt Gleichgewicht.

ES

ERGONOMY DESIGN

No sólo la tecnología y funcionalidad, sino también ergonomía de movimiento. El diseo y la influencia de estilo italiano inciden sabiamente y hacen este parasol único en cada línea, transmitiendo la sensación de equilibrio en las formas





ASTRO CARBON

Ombrellone con innovativo sistema di apertura e chiusura assistito tramite molla a gas. Struttura retrattile che permette apertura e chiusura al di sopra di tavoli e sedie senza dover spostare gli arredi. Connubio tra il futuro e il classico. Adatto per tutti gli ambienti. Telaio in alluminio con effetto antracite metallizzato.

EN

Parasol with innovative opening and closing system assisted by a gas spring. Retractable structure that allows opening and closing above tables and chairs without moving the furniture. Combination between the future and the classic. Suitable for all environments. Aluminum frame with metallic anthracite effect.





DE

Sonnenschirm mit innovativem Öffnungs- und Schliess-System. Mit Unterstützung durch eine Gasfeder einziehbares Gestell, das das Öffnen und Schliessen ueber Tische und Stuehle ermöglicht, ohne die Moebel umzuraeumen Kombination zwischen Zukunft und Klassik. Fuer alle Umgebungen geeignet. Aluminiumgestell mit anthrazitgrau Metallic-Effekt.

FR

Parasol avec système innovant d'ouverture et de fermeture assisté par ressort à gaz. Structure rétractable qui permet d'ouvrir et de fermerle parasol au-dessus des tables et des chaises sans avoir à déplacer le mobilier. Une combinaison du futur et du classique. Convient à tous les environnements. Cadre en aluminium avec effet anthracite métallise.

ES

Parasol con el nuevo sistema de apertura y cierre mediante pistón de gas. Estructura retráctil que permite abrir y cerrar el parasol por encima de las sillas y las mesas sin necesidad de apartar el mobiliario. Fusión entre el futuro y el pasado. Adecuado para todos los ambientes. Estructura de aluminio con efecto antracita metalizado.

NL

Parasol met innovatief openings- en sluitsysteem, ondersteund door een gasveer. Intrekbaar naar de mast met systeem dat openen en sluiten boven tafels en stoelen mogelijk maakt zonder het meubilair te verplaatsen. Combinatie tussen de toekomst en de klassieker. Geschikt voor alle locaties. Aluminium frame met antraciet metallic effect.

- 300x300 | 350x350
- 300x400

ASTRO STARWHITE

Ombrellone con innovativo sistema di apertura e chiusura assistito tramite molla a gas. Struttura retrattile che permette apertura e chiusura al di sopra di tavoli e sedie senza dover spostare gli arredi. Elegante modello con telaio in alluminio e finitura colore bianco Starwhite opaco.

EN

Parasol with innovative opening and closing system assisted by a gas spring. Retractable structure that allows opening and closing above tables and chairs without moving the furniture. Elegant model with aluminium frame with opac Starwhite finish.





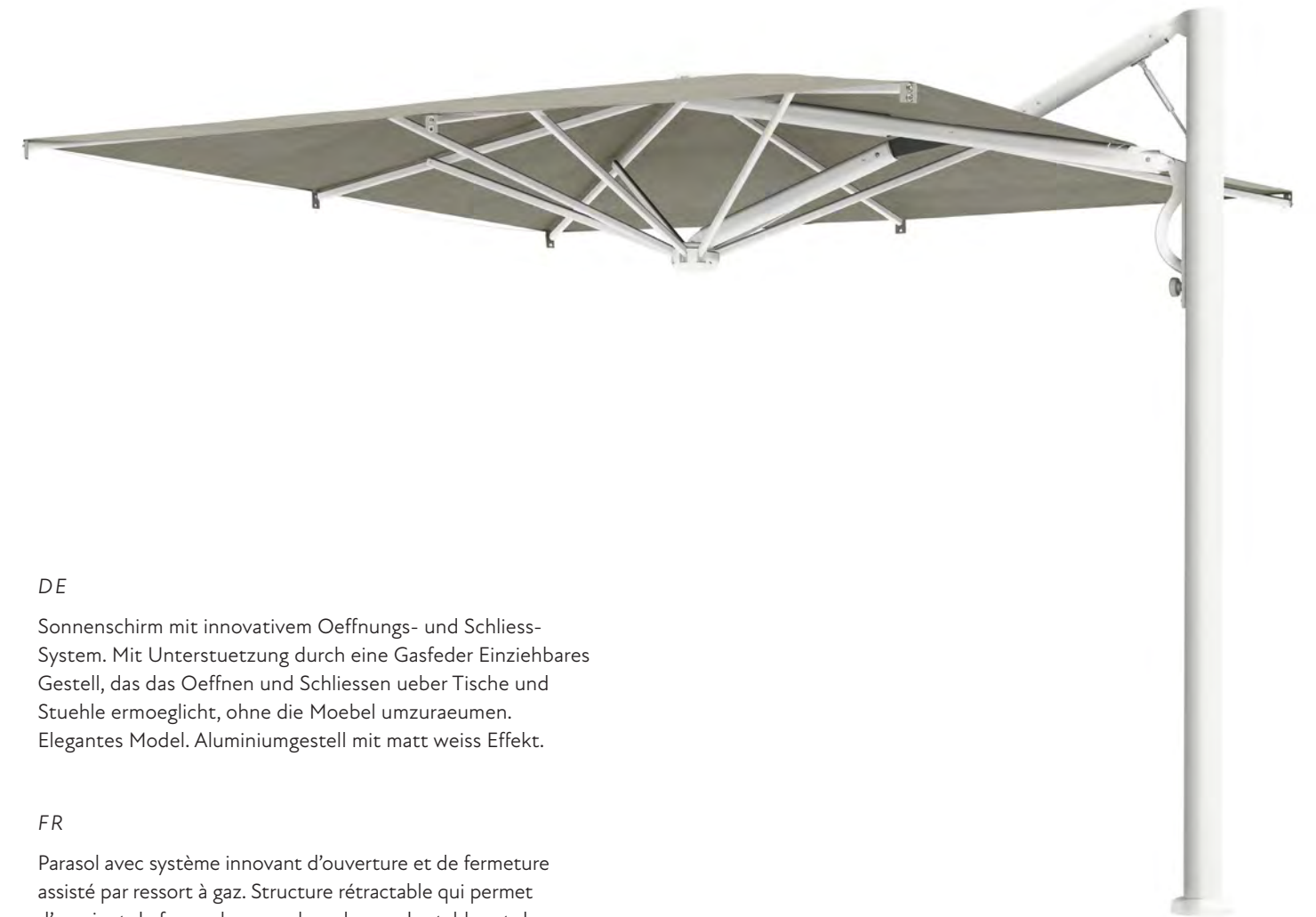

DE

Sonnenschirm mit innovativem Öffnungs- und Schliess-System. Mit Unterstützung durch eine Gasfeder Einziehbares Gestell, das das Öffnen und Schliessen ueber Tische und Stuehle ermöglicht, ohne die Moebel umzuräumen. Elegantes Model. Aluminiumgestell mit matt weiss Effekt.

FR

Parasol avec système innovant d'ouverture et de fermeture assisté par ressort à gaz. Structure rétractable qui permet d'ouvrir et de fermer le parasol au-dessus des tables et des chaises sans avoir à déplacer le mobilier. Modèle élégant avec cadre en aluminium et finition blanc mat.

ES

Parasol con el nuevo sistema de apertura y cierre mediante pistón de gas. Estructura retráctil que permite abrir y cerrar el parasol por encima de las sillas y las mesas sin necesidad de apartar el mobiliario. Elegante modelo con estructura de aluminio y acabado de color blanco Starwhite mate.

NL

Parasol met innovatief openings- en sluitsysteem, ondersteund door een gasveer. Intrekbaar naar de mast met systeem dat openen en sluiten boven tafels en stoelen mogelijk maakt zonder het meubilair te verplaatsen. Elegant model met aluminium frame in mat witte afwerking.

300x300 | 350x350

300x400





ASTRO TIMBER

Ombrellone con innovativo sistema di apertura e chiusura assistito tramite molla a gas. Struttura retrattile che permette apertura e chiusura al di sopra di tavoli e sedie senza dover spostare gli arredi. Telaio in alluminio e finitura effetto legno, trattamento resistente all'acqua salata e alla degradazione uv. Effetto innovativo e molto apprezzato nel settore outdoor.

EN

Parasol with innovative opening and closing system assisted by a gas spring. Retractable structure that allows opening and closing above tables and chairs without moving the furniture. With highly durable wood finish aluminum frame. Impervious to saltwater and uv degradation. An innovative and highly appreciated effect in the outdoor branch.



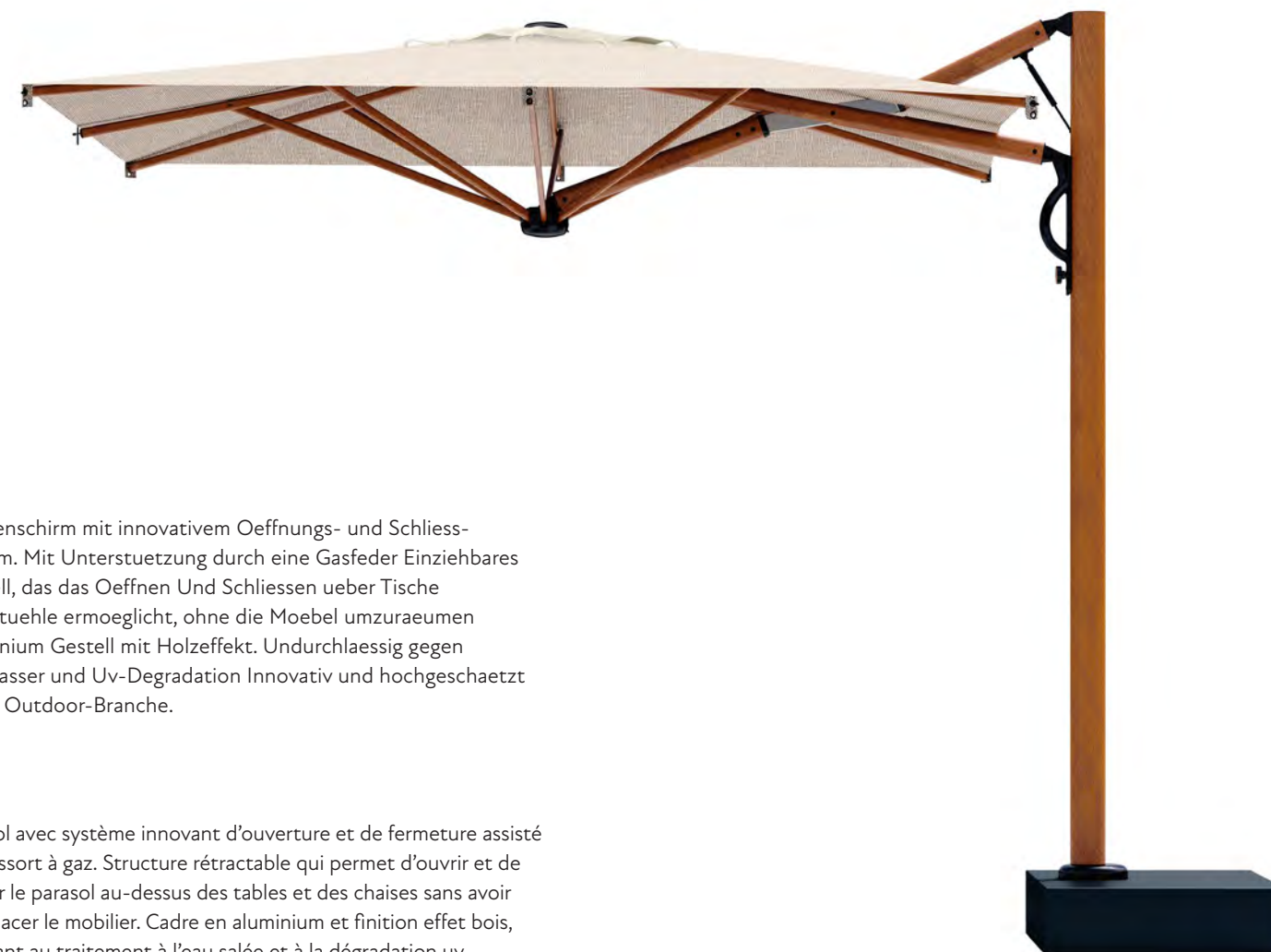
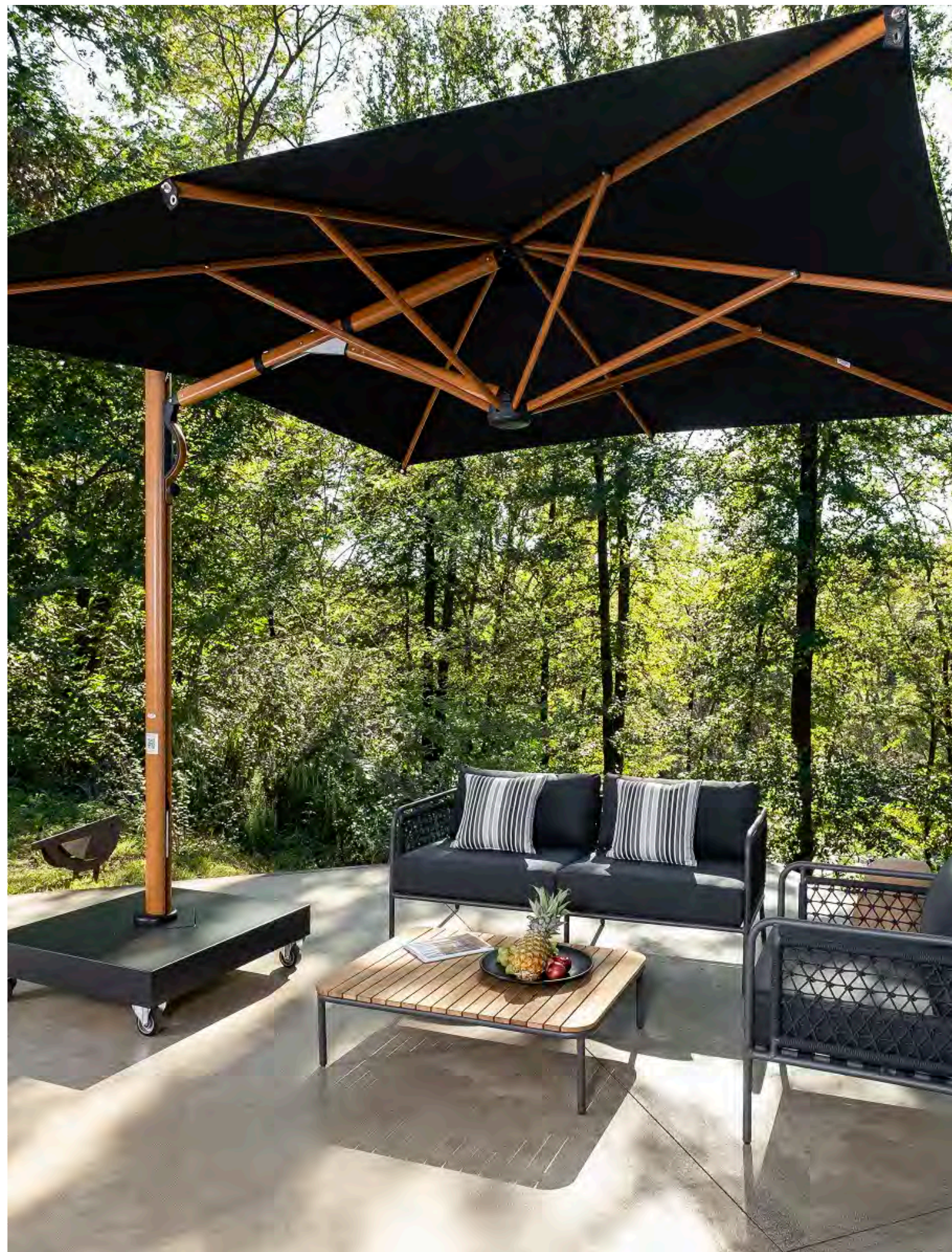

DE

Sonnenschirm mit innovativem Öffnungs- und Schliess-System. Mit Unterstützung durch eine Gasfeder Einziehbares Gestell, das das Öffnen Und Schliessen ueber Tische und Stuehle ermöglicht, ohne die Moebel umzuräumen Aluminium Gestell mit Holzeffekt. Undurchlaessig gegen Salzwasser und Uv-Degradation Innovativ und hochgeschätzt in der Outdoor-Branche.

FR

Parasol avec système innovant d'ouverture et de fermeture assisté par ressort à gaz. Structure rétractable qui permet d'ouvrir et de fermer le parasol au-dessus des tables et des chaises sans avoir à déplacer le mobilier. Cadre en aluminium et finition effet bois, résistant au traitement à l'eau salée et à la dégradation uv. Effet innovant et très apprécié dans le secteur outdoor.

ES

Parasol con el nuevo sistema de apertura y cierre mediante pistón de gas. Estructura retráctil que permite abrir y cerrar el parasol por encima de las sillas y las mesas sin necesidad de apartar el mobiliario. Estructura de aluminio y acabado efecto madera con tratamiento resistente al agua salina y a la degradación por los rayos uv. Acabado novedoso y muy apreciado en el sector outdoor.

NL

Parasol met innovatief openings- en sluitsysteem, ondersteund door een gasveer. Intrekbaar naar de mast met systeem dat openen en sluiten boven tafels en stoelen mogelijk maakt zonder het meubilair te verplaatsen. Met fraai in houtdecor afgewerkt aluminium frame. Ongevoelig voor zout water en uv-degradatie. Een innovatief en zeer gewaardeerd effect in de outdoor branche.

- 300x300 | 350x350
- 300x400





ASTRO TITANIUM

Ombrellone con innovativo sistema di apertura e chiusura assistito tramite molla a gas. Struttura retrattile che permette apertura e chiusura al di sopra di tavoli e sedie senza dover spostare gli arredi. Prodotto moderno con telaio in alluminio finitura effetto titanium. Adatto agli ambienti più ricercati.

EN

Parasol with innovative opening and closing system assisted by a gas spring. Retractable structure that allows opening and closing above tables and chairs without moving the furniture. Modern product. Aluminium frame with titanium effect. Suitable for exclusive environments.



*DE*

Sonnenschirm mit innovativem Öffnungs- und Schliess-System. Mit Unterstützung durch eine Gasfeder Einziehbares Gestell, das das Öffnen und Schliessen ueber Tische und Stuehle ermöglicht, ohne die Moebel umzuraeumen. Modernes ProdENT. Aluminiumgestell mit Titanium Effekt. Fuer exklusive Umgebungen geeignet.

FR

Parasol avec système innovant d'ouverture et de fermeture assisté par ressort à gaz. Structure rétractable qui permet d'ouvrir et de fermer le parasol au-dessus des tables et des chaises sans avoir à déplacer le mobilier. Produit design avec cadre en aluminium finition effet titane. Convient aux environnements les plus prisés.

ES

Parasol con el nuevo sistema de apertura y cierre mediante pistón de gas. Estructura retráctil que permite abrir y cerrar el parasol por encima de las sillas y las mesas sin necesidad de apartar el mobiliario. Producto moderno con estructura de aluminio con acabado efecto titanium. Adecuado para los ambientes más sofisticados.

NL

Parasol met innovatief openings- en sluitsysteem, ondersteund door een gasveer. Intrekbaar naar de mast met systeem dat openen en sluiten boven tafels en stoelen mogelijk maakt zonder het meubilair te verplaatsen. Modern design. Aluminium frame met titanium effect. Geschikt voor exclusieve omgevingen.

 300x300 | 350x350

 300x400



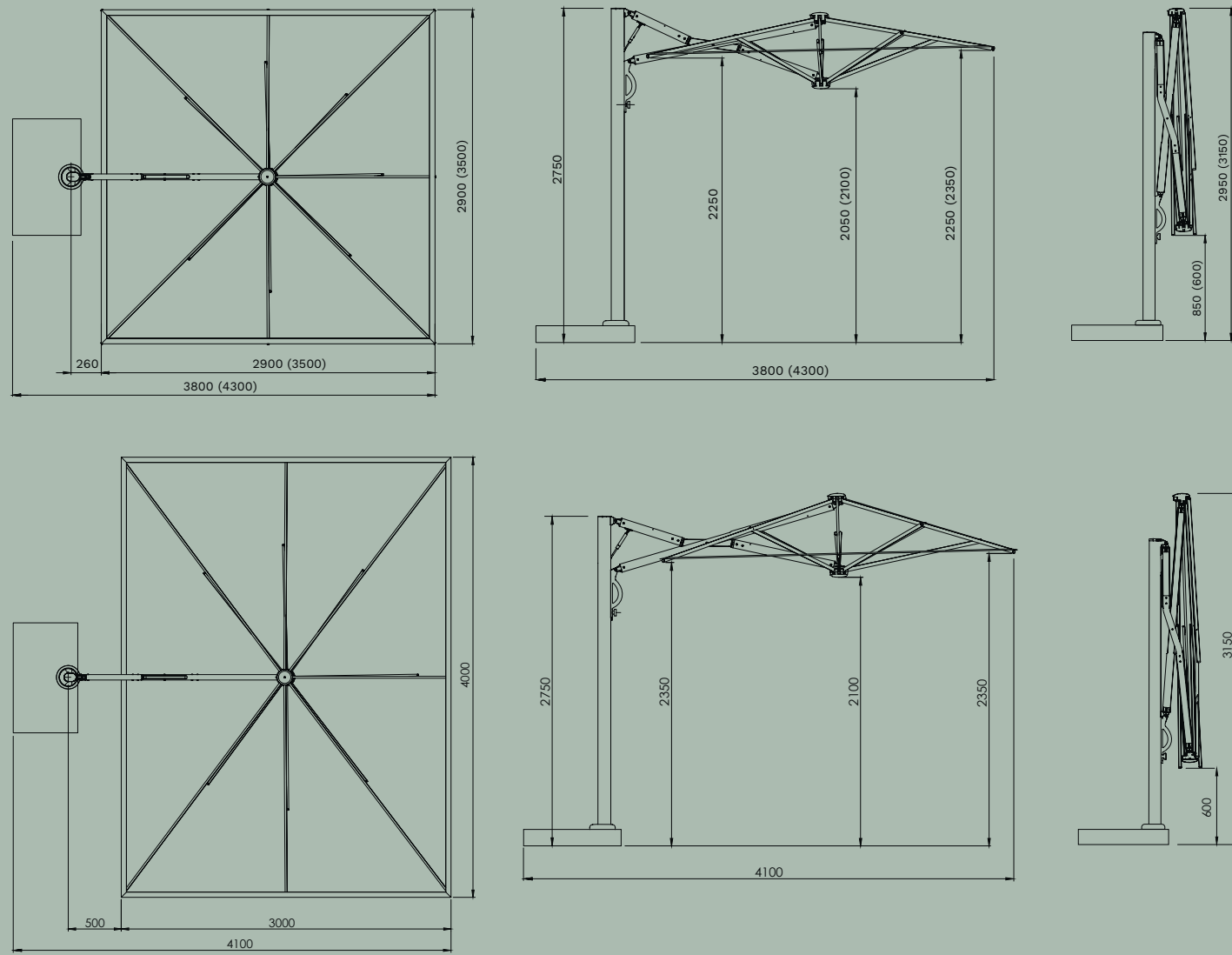

Astro 3x3m - 3,5x3,5m - 3x4m



FINISHING

 • Camino antivento
Wind cap

 • Stecca con sistema "easy change"
Ribs with "easy change" system

 • Ombrellone girevole a 360°C
360-degree rotating umbrella

INOX • Viteria in inox
Screws in Stainless steel

 • Carbon • Timber
• Starwhite • Titanium

 • Carbon • Timber
• Starwhite • Titanium

 • Sistema retrattile
Retractable system

 • Apertura con molla a gas
Gas spring opening

COLOUR RANGE - p. 110
ACRILYC 350GR



ALL OPTIONS



CHARACTERISTICS



Size	Material	Weight (KG)	Volume (M³)	Canopy Size	Ribs	Ground Fixing
3,0x3,0	CARBON C3030 ASC	55	0,45	110x76	8	18x30
	STARWHITE C3030 ASW					
	TIMBER C3030 ASL					
3,5x3,5	TITANIUM C3030 AST	60	0,45	110x76	8	18x30
	CARBON C3535 ASC					
	STARWHITE C3535 ASW					
3,0x4,0	TIMBER C3535 ASL	60	0,45	110x76	8	18x30
	CARBON C3040 ASC					
	STARWHITE C3040 ASW					
3,0x4,0	TITANIUM C3040 AST	60	0,45	110x76	8	18x30
	CARBON C3535 ASC					
	STARWHITE C3535 ASW					

OPTIONAL

BASES p. 100 BALLAST p. 103 GROUND FIXING p. 104

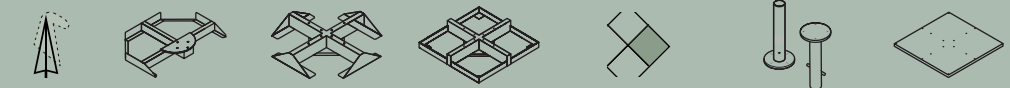

Size	Material	Base	Ballast	Ground Fixing
3,0x3,0	CARBON C3030 ASC	B1DS	PL1DS	BUD8080DS
	STARWHITE C3030 ASW	B1BS	PL1BS	BUD8080BS
	TIMBER C3030 ASL	B1DS	PL1DS	BUD8080DS
	TITANIUM C3030 AST	B1DS	PL1DS	BUD8080DS
3,5x3,5	CARBON C3535 ASC	B1DS	PL1DS	BUD8080DS
	STARWHITE C3535 ASW	B1BS	PL1BS	BUD8080BS
	TIMBER C3535 ASL	B1DS	PL1DS	BUD8080DS
	TITANIUM C3535 AST	B1DS	PL1DS	BUD8080DS
3,0x4,0	CARBON C3040 ASC	B1DS	PL1DS	BUD8080DS
	STARWHITE C3040 ASW	B1BS	PL1BS	BUD8080BS
	TIMBER C3040 ASL	B1DS	PL1DS	BUD8080DS
	TITANIUM C3040 AST	B1DS	PL1DS	BUD8080DS

Base non compresa nel prezzo | Base not included in the price

VERIFICA LA STABILITÀ - p. 106

Check stability - Vérifiez la stabilité - Stabilität prüfen - Compruebe la estabilidad - Controleer de stabiliteit

DUAL "V" CARBON

Evoluzione dell'ombrellone singolo Astro con innovativo sistema di apertura e chiusura assistito tramite molla a gas. Struttura retrattile che permette apertura e chiusura al di sopra di tavoli e sedie senza dover spostare gli arredi. Adatto per tutti gli ambienti e consigliato per uso professionale (bar, ristoranti, hotel e dehor). Telaio in alluminio con effetto antracite metallizzato. Struttura robusta composta da 2 ombrelloni affiancati ed ancorati ad un unico sostegno.

EN

Evolution of the single parasol Astro with innovative opening and closing system assisted by a gas spring. Retractable structure that allows opening and closing above tables and chairs without moving the furniture. Suitable for all environments and recommended for a commercial employ (bars, restaurants, hotels and terrace dehors). Aluminum frame with metallic anthracite effect. Strong structure composed of 2 parasols side by side and anchored to a single support.





DE

Entwicklung des Einzelschirmes Astro mit innovativem Öffnungs- und Schliess-System mit Unterstützung von einer Gasfeder. Einziehbares Gestell, das das Öffnen und Schliessen über Tische und Stühle ermöglicht, ohne die Möbel umzuräumen. Geeignet für alle Umgebungen und empfohlen für einen gewerblichen Einsatz (Bars, Restaurants, Hotels und Terrassen). Aluminiumgestell pulverbeschichtet Anthrazitgrau. Starkes Gestell, bestehend aus 2 Sonnenschirmen, die nebeneinander stehen und an einem Mast verankert sind.

ES

Evolución del parasol individual Astro con el nuevo sistema de apertura y cierre mediante pistón de gas. Estructura retráctil que permite abrir y cerrar el parasol por encima de las sillas y las mesas sin necesidad de apartar el mobiliario. Adecuado para todos los ambientes y recomendado para uso profesional (bar, restaurantes, hoteles y espacios exteriores). Estructura de aluminio con efecto antracita metalizado. Estructura robusta compuesta por 2 parasoles juntos y soportados por un único palo.

FR

Parasols double avec système innovant d'ouverture et de fermeture assisté par ressort à gaz. Structure rétractable qui permet d'ouvrir et de fermer les parasols au-dessus des tables et des chaises sans avoir à déplacer le mobilier. Convient à tous les environnements et recommandé pour un usage professionnel (bars, restaurants, hôtels, collectivités, chr...). Cadre en aluminium effet anthracite métallisé. Structure robuste composée de 2 parasols accroché à un seul mat.

NL

Evolutie van de enkele parasol Astro met innovatief openings- en sluitsysteem ondersteund door een gasveer. Intrekbaar naar de mast met systeem dat openen en sluiten boven tafels en stoelen mogelijk maakt zonder het meubilair te verplaatsen. Geschikt voor alle locaties en aanbevolen voor een commerciële toepassing (bars, restaurants, hotels). Aluminium frame met antraciet metallic effect. Sterke constructie bestaande uit 2 parasols naast elkaar en verankerd aan een enkele mast.



DUAL "V" STARWHITE

Evoluzione dell'ombrellone singolo Astro con innovativo sistema di apertura e chiusura assistito tramite molla a gas. Struttura retrattile che permette apertura e chiusura al di sopra di tavoli e sedie senza dover spostare gli arredi. Adatto per tutti gli ambienti e consigliato per uso professionale (bar, ristoranti, hotel e dehor). Telaio in alluminio con verniciatura bianco Starwhite opaco. Struttura robusta composta da 2 ombrelloni affiancati ed ancorati ad un unico sostegno.

EN

Evolution of the single parasol Astro with innovative opening and closing system assisted by a gas spring. Retractable structure that allows opening and closing above tables and chairs without moving the furniture. Suitable for all environments and recommended for a commercial employ (bars, restaurants, hotels and terrace dehors). Aluminium frame with opac Starwhite finish. Strong structure composed of 2 parasols side by side and anchored to a single support.



**DE**

Entwicklung des Einzelschirmes Astro mit innovativem Öffnungs- und Schliess-System mit Unterstützung von einer Gasfeder. Einziehbares Gestell, das das Öffnen und Schliessen über Tische und Stühle ermöglicht, ohne die Möbel umzuräumen. Geeignet für alle Umgebungen und empfohlen für einen gewerblichen Einsatz (Bars, Restaurants, Hotels und Terrassen) Aluminiumgestell pulverbeschichtet Mattweiss. Starkes Gestell, bestehend aus 2 Sonnenschirmen, die nebeneinander stehen und an einem Mast verankert sind.

FR

Parasols double avec système innovant d'ouverture et de fermeture assisté par ressort à gaz. Structure rétractable qui permet d'ouvrir et de fermer les parasols au-dessus des tables et des chaises sans avoir à déplacer le mobilier. Convient à tous les environnements et recommandé pour un usage professionnel (bars, restaurants, hôtels, collectivité . Chr...). Cadre en aluminium coloris blanc mate. Structure robuste composée de 2 parasols accroché à un seul support.

ES

Evolución del parasol individual Astro con el nuevo sistema de apertura y cierre mediante pistón de gas. Estructura retráctil que permite abrir y cerrar el parasol por encima de las sillas y alas mesas sin necesidad de apartar el mobiliario. Adecuado para todos los ambientes y recomendado para uso profesional (bar, restaurantes, hoteles y espacios exteriores). Estructura de aluminio con pintura blanca Starwhite mate. Estructura robusta compuesta por 2 parasoles juntos y soportados por un único palo.

NL

Evolutie van de enkele parasol Astro met innovatief openings- en sluitsysteem ondersteund door een gasveer. Intrekbaar naar de mast met systeem dat openen en sluiten boven tafels en stoelen mogelijk maakt zonder het meubilair te verplaatsen. Geschikt voor alle locaties en aanbevolen voor een commerciële toepassing (bars, restaurants, hotels). Aluminium frame in mat wit. Sterke constructie bestaande uit 2 parasols naast elkaar en verankerd aan een enkele mast.



DUAL "V" TIMBER

Evoluzione dell'ombrellone singolo Astro con innovativo sistema di apertura e chiusura assistito tramite molla a gas. Struttura retrattile che permette apertura e chiusura a l di sopra di tavoli e sedie senza dover spostare gli arredi. Adatto per tutti gli ambienti e consigliato per uso professionale (bar, ristoranti, hotel e dehor). Telaio in alluminio e finitura effetto legno, trattamento resistente all'acqua salata e alla degradazione uv. Effetto innovativo e molto apprezzato nel settore outdoor. Struttura robusta composta da 2 ombrelloni affiancati ed ancorati ad un unico sostegno.

EN

Evolution of the single parasol Astro with innovative opening and closing system assisted by a gas spring. Retractable structure that allows opening and closing above tables and chairs without moving the furniture. Suitable for all environments and recommended for a commercial employ (bars, restaurants, hotels and terrace dehors). With highly durable wood finish aluminum frame. Impervious to saltwater and uv degradation. An innovative and highly appreciated effect in the outdoor branch. Strong structure composed of 2 parasols side by side and anchored to a single support.





DE

Entwicklung des Einzelschirmes Astro mit innovativem Öffnungs- und Schliess-System mit Unterstützung von einer Gasfeder. Einziehbares Gestell, das das Öffnen und Schliessen über Tische und Stühle ermöglicht, ohne die Möbel umzuräumen. Geeignet für alle Umgebungen und empfohlen für einen gewerblichen Einsatz (Bars, Restaurants, Hotels und Terrassen) Aluminiumgestell mit Holzeffekt. Starkes Gestell, bestehend aus 2 Sonnenschirmen, die nebeneinander stehen und an einem Mast verankert sind.

FR

Parasols double avec système innovant d'ouverture et de fermeture assisté par ressort à gaz. Structure rétractable qui permet d'ouvrir et de fermer les parasols au-dessus des tables et des chaises sans avoir à déplacer le mobilier. Convient à tous les environnements et recommandé pour un usage professionnel (bars, restaurants, collectivités, chr...). Cadre en aluminium effet bois. Traitement résistant à l'eau salée et à la dégradation par les uv. Effet innovant et très apprécié dans le secteur outdoor. Structure robuste composée de 2 parasols accroché à un seul mat.

ES

Evolución del parasol individual Astro con el nuevo sistema de apertura y cierre mediante pistón de gas. Estructura retráctil que permite abrir y cerrar el parasol por encima de las sillas y las mesas sin necesidad de apartar el mobiliario. Adecuado para todos los ambientes y recomendado para uso profesional (bar, restaurantes, hoteles y espacios exteriores). Estructura de aluminio y acabado efecto madera con tratamiento resistente al agua salina y a la degradación por los rayos uv. Acabado novedoso y muy apreciado en el sector outdoor. Estructura robusta compuesta por 2 parasoles juntos y soportados por un único palo.

NL

Evolutie van de enkele parasol Astro met innovatief openings- en sluitsysteem ondersteund door een gasveer. Intrekbaar naar de mast met systeem dat openen en sluiten boven tafels en stoelen mogelijk maakt zonder het meubilair te verplaatsen. Geschikt voor alle locaties en aanbevolen voor een commerciële toepassing (bars, restaurants, hotels). Met fraai in houtdecor afgewerkt aluminium frame. Ongevoelig voor zout water en uv-degradatie. Sterke constructie bestaande uit 2 parasols naast elkaar en verankerd aan een enkele mast.



DUAL "V" TITANIUM

Evoluzione dell'ombrellone singolo Astro con innovativo sistema di apertura e chiusura assistito tramite molla a gas. Struttura retrattile che permette apertura e chiusura al di sopra di tavoli e sedie senza dover spostare gli arredi. Adatto per tutti gli ambienti e consigliato per uso professionale (bar, ristoranti, hotel e dehor). Telaio in alluminio con effetto Titanium. Struttura robusta composta da 2 ombrelloni affiancati ed ancorati ad un unico sostegno.

EN

Evolution of the single Astro umbrella with innovative gas piston assisted opening and closing system. Retractable structure that allows opening and closing above tables and chairs without having to move furniture. Suitable for all environments and recommended for Professional application (bars, restaurants, hotels and outdoor areas). Aluminum frame with Titanium effect. Sturdy structure composed of 2 umbrellas side by side and anchored to a single support.





300x600

DE

Entwicklung des Einzelschirmes Astro mit innovativem Öffnungs- und Schliess-System mit Unterstützung von einer Gasfeder. Einziehbares Gestell, das das Öffnen und Schliessen über Tische und Stühle ermöglicht, ohne die Möbel umzuräumen. Geeignet für alle Umgebungen und empfohlen für einen gewerblichen Einsatz (Bars, Restaurants, Hotels und Terrassen) Aluminiumgestell mit Titanium-Effekt. Starkes Gestell, bestehend aus 2 Sonnenschirmen, die nebeneinander stehen und an einem Mast verankert sind.

FR

Evolution du parasol simple Astro avec système innovant d'ouverture et de fermeture assistée par un ressort à gaz. Structure rétractable qui permet d'ouvrir et de fermer au-dessus des tables et des chaises sans déplacer le mobilier. Adapté à tous les environnements et recommandé pour un usage professionnel (bars, restaurants, hôtels et espaces extérieurs). Structure en aluminium effet Titane. Structure robuste composée par 2 parasols placés côte à côte et fixés à un seul support.

ES

Evolución del parasol individual Astro con innovador sistema de apertura y cierre asistido por resorte de gas. Estructura retráctil que permite abrir y cerrar encima de mesas y sillas sin mover el mobiliario. Apto para todos los ambientes y recomendado para uso profesional (bares, restaurantes, hoteles y zonas exteriores). Estructura de aluminio con efecto Titanio. Robusta estructura formada por 2 sombrillas colocadas una al lado de la otra y unidas por un solo soporte

NL

Evolutie van de Astro parasol met innovatieve gasveer voor het openen en sluiten. Intrekbaar frame, waarmee de parasol boven tafels en stoelen kan worden geopend en gesloten zonder dat het meubilair hoeft te worden verplaatst. Geschikt voor alle omgevingen en aanbevolen voor professioneel gebruik (bars, restaurants, hotels en terrassen). Aluminium frame met titanium-look. Stevige structuur bestaande uit 2 parasols aan 1 mast. De parasols hangen in een V-vorm.

DUAL "V" 2,5x5m **NEW** - 3x6m

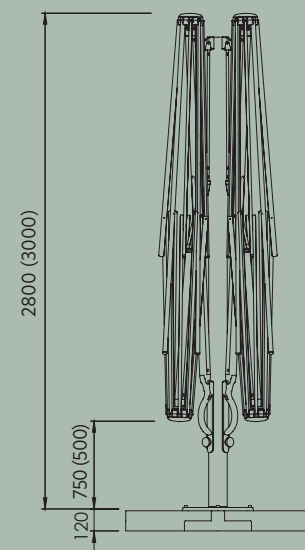
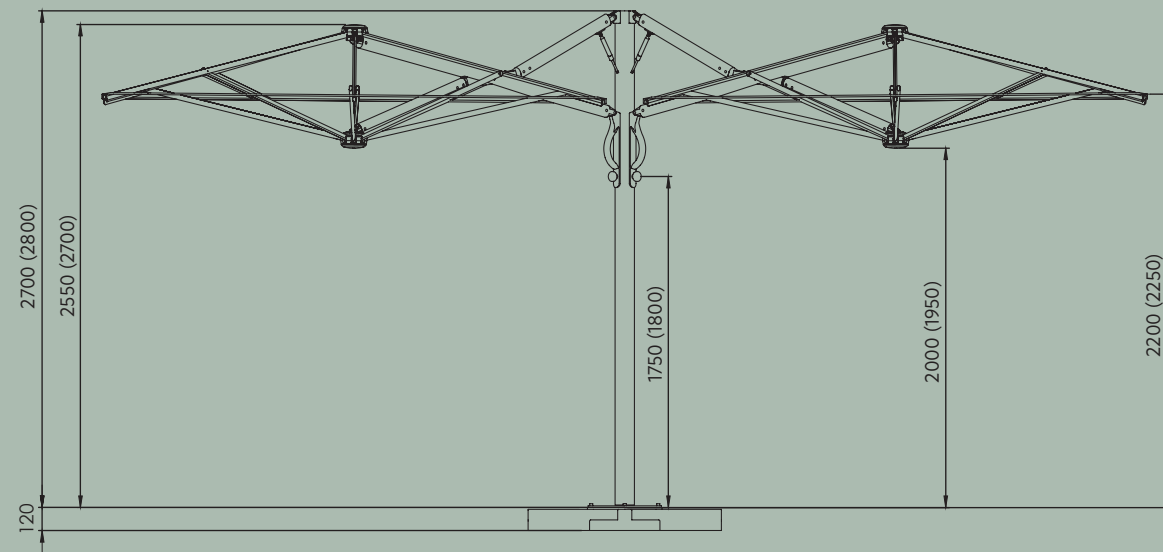
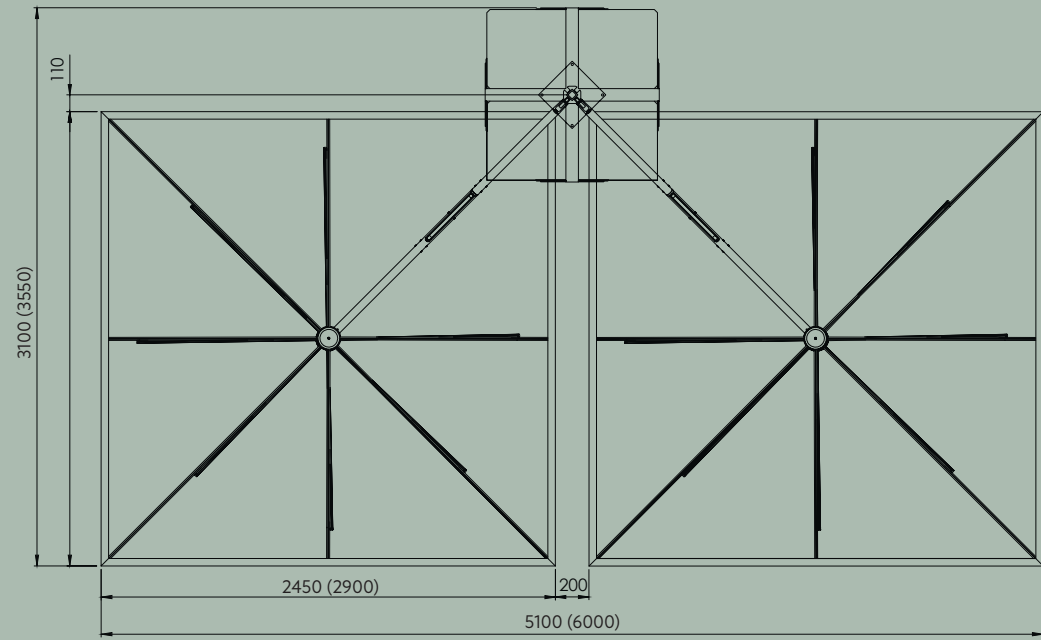

CHARACTERISTICS

		KG	M ³			
2,5x5,0	CARBON C2550 DVC	110	0,60	110x110	8	18x30
	STARWHITE C2550 DVW					
3,0x6,0	CARBON C3060 DVC	120	0,60	110x110	8	18x30
	STARWHITE C3060 DVW					
	TIMBER C3060 DVL					
	TITANIUM C3060 DVT					

BASES p. 100

BALLAST p. 103

GROUND FIXING p. 104

OPTIONAL

2,5x5,0	CARBON C2550 DVC	PL1DS	BUD8080DS	◆	BTBS	CP6565ZS
	STARWHITE C2550 DVW	PL1BS	BUD8080BS			
3,0x6,0	CARBON C3060 DVC	PL1DS	BUD8080DS	◆	BTBS	CP6565ZS
	STARWHITE C3060 DVW	PL1BS	BUD8080BS			
	TIMBER C3060 DVL	PL1DS	BUD8080DS			
	TITANIUM C3060 DVT	PL1DS	BUD8080DS			

Base non compresa nel prezzo | Base not included in the price

FINISHING



• Camino antivento
Wind cap



• Stecca con sistema "easy change"
Ribs with "easy change" system

INOX

• Viteria in inox
Screws in Stainless steel



• Carbon
• Starwhite
• Timber
• Titanium



• Carbon
• Starwhite
• Timber
• Titanium



• Sistema retrattile
Retractable system



• Apertura con molla a gas
Gas spring opening

COLOUR RANGE - p. 110
ACRILYC 350GR



ALL OPTIONS



DUAL "T" CARBON

Evoluzione dell'ombrellone singolo Astro con innovativo sistema di apertura e chiusura assistito tramite molla a gas. Struttura retrattile che permette apertura e chiusura al di sopra di tavoli e sedie senza dover spostare gli arredi. Adatto per tutti gli ambienti e consigliato per uso professionale (bar, ristoranti, hotel e dehor). Telaio in alluminio con effetto antracite metallizzato. Struttura robusta composta da 2 ombrelloni opposti ancorati ad un unico sostegno e posizionati in modo simmetrico.

EN

Evolution of the single parasol Astro with innovative opening and closing system assisted by a gas spring. Retractable structure that allows opening and closing above tables and chairs without moving the furniture. Suitable for all environments and recommended for a commercial employ (bars, restaurants, hotels and terrace dehors). Aluminum frame with metallic anthracite effect. Strong structure composed of 2 parasols anchored to a single support and positioned in a symmetrical way.





300x600 | 350x700

DE

Entwicklung des Einzelschirmes Astro mit innovativem Öffnungs- und Schliess-System mit Unterstützung von einer Gasfeder. Einziehbares Gestell, das das Öffnen und Schliessen über Tische und Stühle ermöglicht, ohne die Möbel umzuräumen. Geeignet für alle Umgebungen und empfohlen für einen gewerblichen Einsatz (Bars, Restaurants, Hotels und Terrassen) pulverbeschichtete Farbe Anthrazitgrau. Starkes Gestell, bestehend aus 2 gegenüberliegenden Sonnenschirmen, die symmetrisch an einem Mast verankert sind.

FR

Parasols double avec système innovant d'ouverture et de fermeture assisté par ressort à gaz. Structure rétractable qui permet d'ouvrir et de fermer les parasols au-dessus des tables et des chaises sans avoir à déplacer le mobilier. Convient à tous les environnements et recommandé pour un usage professionnel (bars, restaurants, collectivités, chr...). Cadre en aluminium effet anthracite métallisé. Structure robuste composée de 2 parasols accroché à un seul mât et positionnés symétriquement.

ES

Evolución del parasol individual Astro con el nuevo sistema de apertura y cierre mediante pistón de gas. Estructura retráctil que permite abrir y cerrar el parasol por encima de las sillas y las mesas sin necesidad de apartar el mobiliario. Adecuado para todos los ambientes y recomendado para uso profesional (bar, restaurantes, hoteles y espacios exteriores). Estructura de aluminio con efecto antracita metalizado. Estructura robusta compuesta por 2 parasoles opuestos y soportados por un único palo, posicionados en modo simétrico.

NL

Evolutie van de enkele parasol Astro met innovatief openings- en sluitsysteem ondersteund door een gasveer. Intrekbaar naar de mast met systeem dat openen en sluiten boven tafels en stoelen mogelijk maakt zonder het meubilair te verplaatsen. Geschikt voor alle locaties en aanbevolen voor een commerciële toepassing (bars, restaurants, hotels). Aluminium frame met antraciet metallic effect. Sterke constructie bestaande uit 2 parasols symmetrisch naast elkaar en verankerd aan een enkele mast.

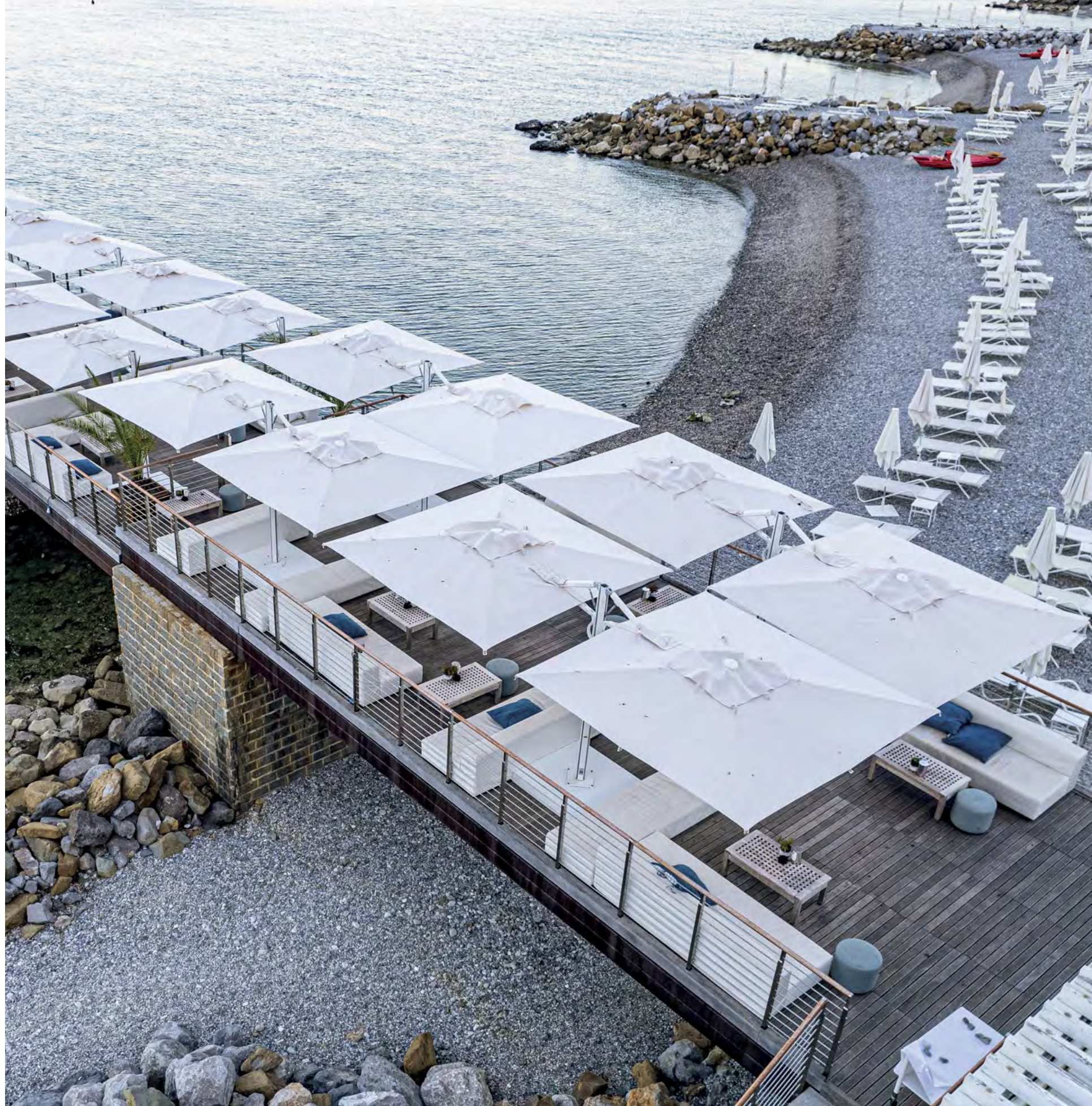

DUAL "T" STARWHITE

Evoluzione dell'ombrellone singolo Astro con innovativo sistema di apertura e chiusura assistito tramite molla a gas. Struttura retrattile che permette apertura e chiusura al di sopra di tavoli e sedie senza dover spostare gli arredi. Adatto per tutti gli ambienti e consigliato per uso professionale (bar, ristoranti, hotel e dehor). Telaio in alluminio con verniciatura bianco Starwhite opaco. Struttura robusta composta da 2 ombrelloni opposti ancorati ad un unico sostegno e posizionati in modo simmetrico.

EN

Evolution of the single parasol Astro with innovative opening and closing system assisted by a gas spring. Retractable structure that allows opening and closing above tables and chairs without moving the furniture. Suitable for all environments and recommended for a commercial employ (bars, restaurants, hotels and terraces dehors). Aluminium frame with opac Starwhite finish. Strong structure composed of 2 parasols anchored to a single support and positioned in a symmetrical way.



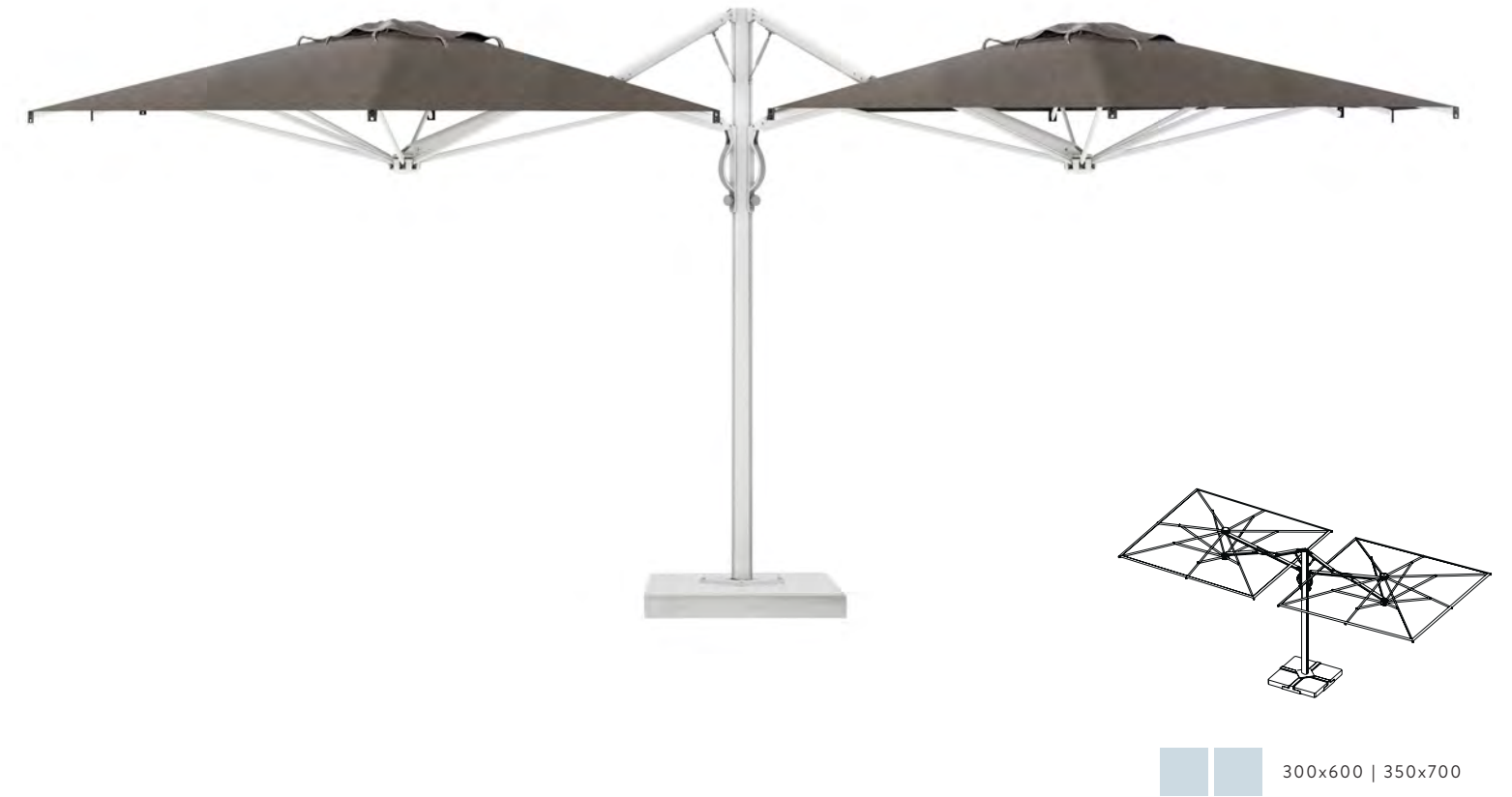

300x600 | 350x700

DE

Entwicklung des Einzelschirmes Astro mit innovativem Öffnungs- und Schliess-System mit Unterstützung von einer Gasfeder. Einziehbares Gestell, das das Öffnen und Schliessen über Tische und Stühle ermöglicht, ohne die Möbel umzuräumen. Geeignet für alle Umgebungen und empfohlen für einen gewerblichen Einsatz (Bars, Restaurants, Hotels und Terrassen) Aluminiumgestell pulverbeschichtet Mattweiss. Starkes Gestell, bestehend aus 2 gegenüberliegenden Sonnenschirmen, die symmetrisch an einem Mast verankert sind.

FR

Parasols double avec système innovant d'ouverture et de fermeture assisté par ressort à gaz. Structure rétractable qui permet d'ouvrir et de fermer les parasols au-dessus des tables et des chaises sans avoir à déplacer le mobilier. Convient à tous les environnements et recommandé pour un usage professionnel (bars, restaurants, collectivité, ch...). Cadre en aluminium coloris blanc mate. Structure robuste composée de 2 parasols accroché à un seul support mat et positionnés symétriquement.

ES

Evolución del parasol individual Astro con el nuevo sistema de apertura y cierre mediante pistón de gas. Estructura retráctil que permite abrir y cerrar el parasol por encima de las sillas y las mesas sin necesidad de apartar el mobiliario. Adecuado para todos los ambientes y recomendado para uso profesional (bar, restaurantes, hoteles y espacios exteriores). Estructura de aluminio con pintura blanca Starwhite mate. Estructura robusta compuesta por 2 parasoles opuestos, soportados por un único palo y posicionados en modo simétrico.

NL

Evolutie van de enkele parasol Astro met innovatief openings- en sluitsysteem ondersteund door een gasveer. Intrekbaar naar de mast met systeem dat openen en sluiten boven tafels en stoelen mogelijk maakt zonder het meubilair te verplaatsen. Geschikt voor alle locaties en aanbevolen voor een commerciële toepassing (bars, restaurants, hotels). Aluminium frame in mat wit. Sterke constructie bestaande uit 2 parasols symmetrisch naast elkaar en verankerd aan een enkele mast.

DUAL "T" TIMBER

68 Evoluzione dell'ombrellone singolo Astro con innovativo sistema di apertura e chiusura assistito tramite molla a gas. Struttura retrattile che permette apertura e chiusura al di sopra di tavoli e sedie senza dover spostare gli arredi. Adatto per tutti gli ambienti e consigliato per uso professionale (bar, ristoranti, hotel e dehor). Telaio in alluminio e finitura effetto legno, trattamento resistente all'acqua salata e alla degradazione uv. Effetto innovativo e molto apprezzato nel settore outdoor. Struttura robusta composta da 2 ombrelloni opposti ancorati ad un unico sostegno e posizionati in modo simmetrico.

EN

Evolution of the single parasol Astro with innovative opening and closing system assisted by a gas spring. Retractable structure that allows opening and closing above tables and chairs without moving the furniture. Suitable for all environments and recommended for a commercial employ (bars, restaurants, hotels and terrace dehors). With highly durable wood finish aluminum frame. Impervious to saltwater and uv degradation. An innovative and highly appreciated effect in the outdoor branch. Strong structure composed of 2 parasols anchored to a single support and positioned in a symmetrical way.





300x600 | 350x700

DE

Entwicklung des Einzelschirmes Astro mit innovativem Öffnungs- und Schliess-System mit Unterstützung von einer Gasfeder. Einziehbares Gestell, das das Öffnen und Schliessen über Tische und Stühle ermöglicht, ohne die Möbel umzuräumen. Geeignet für alle Umgebungen und empfohlen für einen gewerblichen Einsatz (Bars, Restaurants, Hotels und Terrassen) Aluminiumgestell mit Holzeffekt. Starkes Gestell, bestehend aus 2 gegenüberliegenden Sonnenschirmen, die symmetrisch an einem Mast verankert sind.

FR

Parasols double avec système innovant d'ouverture et de fermeture assisté par ressort à gaz. Structure rétractable qui permet d'ouvrir et de fermer les parasols au-dessus des tables et des chaises sans avoir à déplacer le mobilier. Convient à tous les environnements et recommandé pour un usage professionnel (bars, restaurants, collectivités, chr...). Cadre en aluminium effet bois. Traitement résistant à l'eau salée et à la dégradation par les uv. Effet innovant et très apprécié dans le secteur outdoor. Structure robuste composée de 2 parasols accroché à un seul support mat et positionnés symétriquement.

ES

Evolución del parasol individual Astro con el nuevo sistema de apertura y cierre mediante pistón de gas. Estructura retráctil que permite abrir y cerrar el parasol por encima de las sillas y las mesas sin necesidad de apartar el mobiliario. Adecuado para todos los ambientes y recomendado para uso profesional (bar, restaurantes, hoteles y espacios exteriores). Estructura de aluminio y acabado efecto madera con tratamiento resistente al agua salina y a la degradación por los rayos uv. Acabado novedoso y muy apreciado en el sector outdoor. Estructura robusta compuesta por 2 parasoles opuestos, soportados por un único palo y posicionados en modo simétrico.

NL

Evolutie van de enkele parasol Astro met innovatief openings- en sluitsysteem ondersteund door een gasveer. Intrekbaar naar de mast met systeem dat openen en sluiten boven tafels en stoelen mogelijk maakt zonder het meubilair te verplaatsen. Geschikt voor alle locaties en aanbevolen voor een commerciële toepassing (bars, restaurants, hotels). Met fraai in houtdecor afgewerkt aluminium frame. Ongevoelig voor zout water en uv-degradatie. Sterke constructie bestaande uit 2 parasols symmetrisch naast elkaar en verankerd aan een enkele mast.



DUAL "T" TITANIUM

Evoluzione dell'ombrellone singolo Astro con innovativo sistema di apertura e chiusura assistito tramite molla a gas. Struttura retrattile che permette apertura e chiusura al di sopra di tavoli e sedie senza dover spostare gli arredi. Adatto per tutti gli ambienti e consigliato per uso professionale (bar, ristoranti, hotel e dehor). Telaio in alluminio con effetto titanium. Struttura robusta composta da 2 ombrelloni opposti ancorati ad un unico sostegno e posizionati in modo simmetrico.

EN

Evolution of the single Astro umbrella with innovative Gas piston assisted opening and closing system. Retractable structure that allows opening and closing above tables and chairs without having to move furniture. Suitable for all environments and recommended for Professional application (bars, restaurants, hotels and outdoor areas). Aluminum frame with titanium effect. Sturdy structure consisting of 2 opposing umbrellas anchored to a single support and positioned symmetrically.





300x600 | 350x700

DE

Entwicklung des Einzelschirmes Astro mit innovativem Öffnungs- und Schliess-System mit Unterstützung von einer Gasfeder. Einziehbares Gestell, das das Öffnen und Schliessen über Tische und Stühle ermöglicht, ohne die Möbel umzuarbeiten. Geeignet für alle Umgebungen und empfohlen für einen gewerblichen Einsatz (Bars, Restaurants, Hotels und Terrassen) Aluminiumgestell mit Titanium-Effekt. Starkes Gestell, bestehend aus 2 gegenüberliegenden Sonnenschirmen, die symmetrisch an einem Mast verankert sind.

FR

Evolution du parasol simple Astro avec système innovant d'ouverture et de fermeture assistée par un ressort à gaz. Structure rétractable qui permet d'ouvrir et de fermer au-dessus des tables et des chaises sans déplacer le mobilier. Adapté à tous les environnements et recommandé pour un usage professionnel (bars, restaurants, hôtels et espaces extérieurs). Structure en aluminium effet Titane. Structure robuste composée par 2 parasols opposés, positionnés symétriquement et fixés à un seul support.

ES

Evolución del parasol individual Astro con innovador sistema de apertura y cierre asistido por resorte de gas. Estructura retráctil que permite abrir y cerrar encima de mesas y sillas sin mover el mobiliario. Apto para todos los ambientes y recomendado para uso profesional (bares, restaurantes, hoteles y zonas exteriores). Estructura de aluminio con efecto Titanio. Estructura robusta compuesta por 2 sombrillas opuestas, colocadas simétricamente y unidas por un solo soporte.

NL

Evolutie van de Astro parasol met innovatieve gasveer voor openen en sluiten. Intrekbaar frame waarmee de parasol boven tafels en stoelen kan worden geopend en gesloten zonder dat het meubilair hoeft te worden verplaatst. Geschikt voor alle omgevingen en aanbevolen voor professioneel gebruik (bars, restaurants, hotels en terrassen). Aluminium frame met titanium-look. Stevige structuur bestaande uit 2 parasols die tegenover elkaar aan 1 mast hangen. De parasols hangen in een T-vorm.

DUAL "T" 3x6m - 3,5x7m

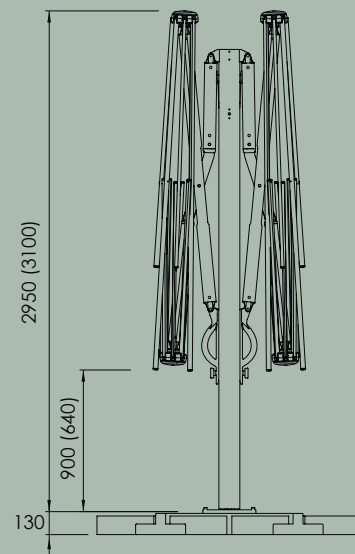
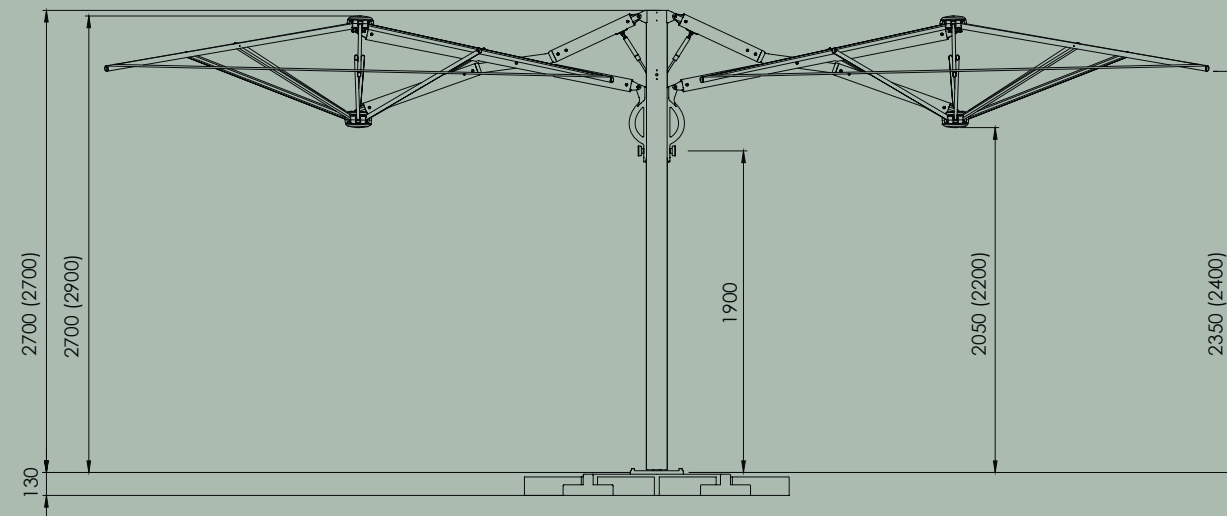
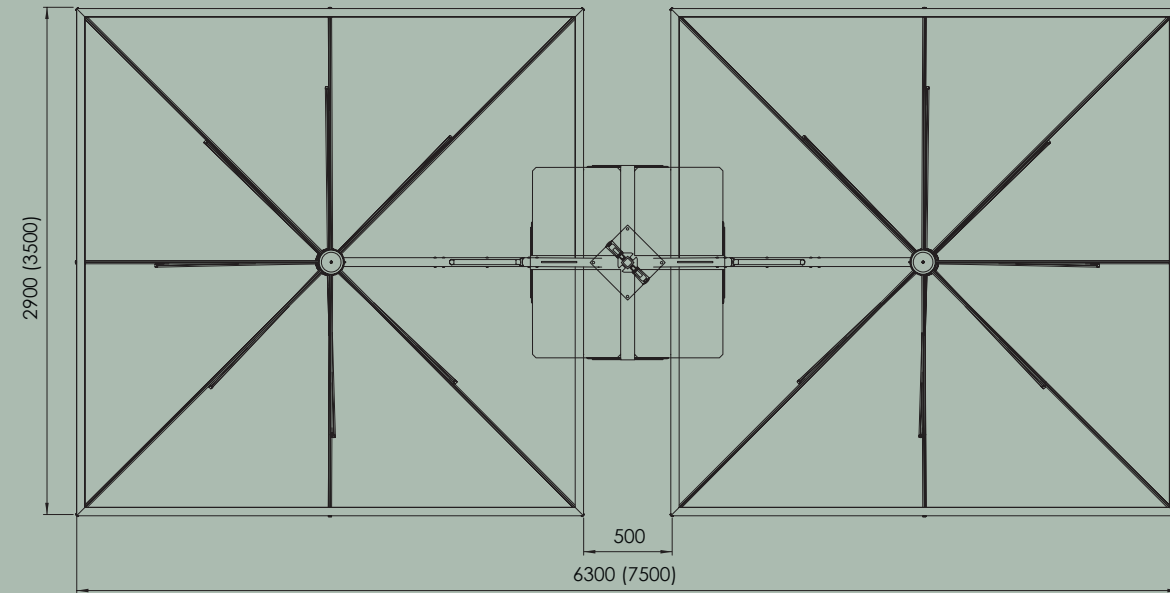

CHARACTERISTICS



Size	Material	Weight (KG)	Volume (M³)	Canopy Shape	Ribs	Rib Width
3,0x6,0	CARBON C3060 DTC	120	0,60	110x110	8	18x30
	STARWHITE C3060 DTW					
	TIMBER C3060 DTL					
	TITANIUM C3060 DTT					
3,5x7,0	CARBON C3570 DTC	125	0,60	110x100	8	18x30
	STARWHITE C3570 DTW					
	TIMBER C3570 DTL					
	TITANIUM C3570 DTT					

OPTIONAL

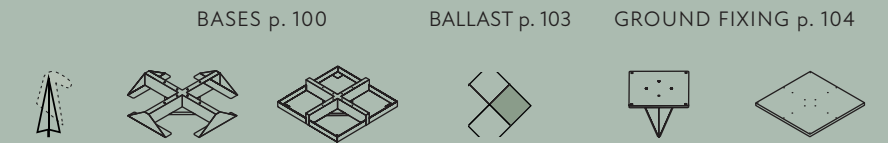

Size	Material	Base	Ballast	Ground Fixing
3,0x6,0	CARBON C3060 DVC	PL1DS	BUD8080DS	BTBS CP6565ZS
	STARWHITE C3060 DVW	PL1BS	BUD8080BS	
	TIMBER C3060 DVL	PL1DS	BUD8080DS	
	TITANIUM C3060 DTT	PL1DS	BUD8080DS	
3,5x7,0	CARBON C3570 DTC	PL1DS	BUD8080DS	BTBS CP6565ZS
	STARWHITE C3570 DTW	PL1BS	BUD8080BS	
	TIMBER C3570 DTL	PL1DS	BUD8080DS	
	TITANIUM C3570 DTT	PL1DS	BUD8080DS	

Base non compresa nel prezzo | Base not included in the price

FINISHING

- Camino antivento / Wind cap
- Sistema retrattile / Retractable system
- Stecca con sistema "easy change" / Ribs with "easy change" system
- Apertura con molla a gas / Gas spring opening
- Viteria in inox / Screws in Stainless steel
- Carbon, Starwhite, Timber, Titanium

COLOUR RANGE - p. 110
ACRILYC 350GR





QUATTRO CARBON

Evoluzione dell'ombrellone singolo Astro con innovativo sistema di apertura e chiusura assistito tramite molla a gas. Struttura retrattile che permette apertura e chiusura al di sopra di tavoli e sedie senza dover spostare gli arredi. Adatto per tutti gli ambienti e consigliato per uso professionale (bar, ristoranti, hotel e dehor). Telaio in alluminio con effetto antracite metallizzato. Struttura robusta composta da 4 ombrelloni ancorati ad un unico sostegno.

EN

Evolution of the single parasol Astro with innovative opening and closing system assisted by a gas spring. Retractable structure that allows opening and closing above tables and chairs without moving the furniture. Suitable for all environments and recommended for a commercial employ (bars, restaurants, hotels and terrace dehors). Aluminum frame with metallic anthracite effect. Strong structure composed of 4 parasols anchored to a single support.



*DE*

Entwicklung des Einzelschirmes Astro mit innovativem Öffnungs- und Schliess-System mit Unterstützung von einer Gasfeder. Einziehbares Gestell, das das Öffnen und Schliessen über Tische und Stühle ermöglicht, ohne die Möbel umzuräumen. Geeignet für alle Umgebungen und empfohlen für einen gewerblichen Einsatz (Bars, Restaurants, Hotels und Terrassen) pulverbeschichtet Farbe Anthrazitgrau. Starkes Gestell, bestehend aus 4 Sonnenschirmen, die an einem Mast verankert sind.

FR

Parasol quadruple avec système innovant d'ouverture et de fermeture assisté par ressort à gaz. Structure rétractable qui permet d'ouvrir et de fermer le parasol au-dessus des tables et des chaises sans avoir à déplacer le mobilier. Convient à tous les environnements et recommandé pour un usage professionnel (bars, restaurants, collectivités, chr...). Cadre en aluminium à effet anthracite métallisé. Structure robuste composée de 4 parasols accrochés à un seul mat.

ES

Evolución del parasol individual Astro con el nuevo sistema de apertura y cierre mediante pistón de gas. Estructura retráctil que permite abrir y cerrar el parasol por encima de las sillas y las mesas sin necesidad de apartar el mobiliario. Adecuado para todos los ambientes y recomendado para uso profesional (bar, restaurantes, hoteles y espacios exteriores). Estructura de aluminio con efecto antracita metalizado. Estructura robusta compuesta por 4 parasoles soportados por un único palo.

NL

Evolutie van de enkele parasol Astro met innovatief openings- en sluitsysteem ondersteund door een gasveer. Intrekbaar naar de mast met systeem dat openen en sluiten boven tafels en stoelen mogelijk maakt zonder het meubilair te verplaatsen. Geschikt voor alle locaties en aanbevolen voor een commerciële toepassing (bars, restaurants, hotels). Aluminium frame met antraciet metallic effect. Sterke constructie bestaande uit 4 parasols verankerd aan een enkele mast.

QUATTRO STARWHITE

Evoluzione dell'ombrellone singolo Astro con innovativo sistema di apertura e chiusura assistito tramite molla a gas. Struttura retrattile che permette apertura e chiusura al di sopra di tavoli e sedie senza dover spostare gli arredi. Adatto per tutti gli ambienti e consigliato per uso professionale (bar, ristoranti, hotel e dehor). Telaio in alluminio con verniciatura bianco Starwhite opaco. Struttura robusta composta da 4 ombrelloni ancorati ad un unico sostegno.

EN

Evolution of the single parasol Astro with innovative opening and closing system assisted by a gas spring. Retractable structure that allows opening and closing above tables and chairs without moving the furniture. Suitable for all environments and recommended for a commercial employ (bars, restaurants, hotels and terrace dehors). Aluminium frame with opac Starwhite finish. Strong structure composed of 4 parasols anchored to a single support.





DE

Entwicklung des Einzelschirmes Astro mit innovativem Öffnungs- und Schliess-System mit Unterstützung von einer Gasfeder. Einziehbares Gestell, das das Öffnen und Schliessen über Tische und Stühle ermöglicht, ohne die Möbel umzuräumen. Geeignet für alle Umgebungen und empfohlen für einen gewerblichen Einsatz (Bars, Restaurants, Hotels und Terrassen) Aluminiumgestell pulverbeschichtet Mattweiss. Starkes Gestell, bestehend aus 4 Sonnenschirmen, die an einem Mast verankert sind.

ES

Evolución del parasol individual Astro con el nuevo sistema de apertura y cierre mediante pistón de gas. Estructura retráctil que permite abrir y cerrar el parasol por encima de las sillas y las mesas sin necesidad de apartar el mobiliario. Adecuado para todos los ambientes y recomendado para uso profesional (bar, restaurantes, hoteles y espacios exteriores). Estructura de aluminio con pintura blanca Starwhite mate. Estructura robusta compuesta por 4 parasoles soportados por un único palo.

FR

Parasol quadruple avec système innovant d'ouverture et de fermeture assisté par ressort à gaz. Structure rétractable qui permet d'ouvrir et de fermer le parasol au-dessus des tables et des chaises sans avoir à déplacer le mobilier. Convient à tous les environnements et recommandé pour un usage professionnel (bars, restaurants, collectivités, chr....). Cadre en aluminium coloris blanc mat. Structure robuste composée de 4 parasols accrochés à un seul mat.

NL

Evolutie van de enkele parasol Astro met innovatief openings- en sluitsysteem ondersteund door een gasveer. Intrekbaar naar de mast met systeem dat openen en sluiten boven tafels en stoelen mogelijk maakt zonder het meubilair te verplaatsen. Geschikt voor alle locaties en aanbevolen voor een commerciële toepassing (bars, restaurants, hotels). Aluminium frame in mat wit. Sterke constructie bestaande uit 4 parasols verankerd aan een enkele mast.



QUATTRO TIMBER

Evoluzione dell'ombrellone singolo Astro con innovativo sistema di apertura e chiusura assistito tramite molla a gas. Struttura retrattile che permette apertura e chiusura al di sopra di tavoli e sedie senza dover spostare gli arredi. Adatto per tutti gli ambienti e consigliato per uso professionale (bar, ristoranti, hotel e dehor). Telaio in alluminio e finitura effetto legno, trattamento resistente all'acqua salata e alla degradazione uv. Effetto innovativo e molto apprezzato nel settore outdoor. Struttura robusta composta da 4 ombrelloni ancorati ad un unico sostegno.

EN

Evolution of the single parasol Astro with innovative opening and closing system assisted by a gas spring. Retractable structure that allows opening and closing above tables and chairs without moving the furniture. Suitable for all environments and recommended for a commercial employ (bars, restaurants, hotels and terrace dehors). With highly durable wood finish aluminum frame. Impervious to saltwater and uv degradation. An innovative and highly appreciated effect in the outdoor branch. Strong structure composed of 4 parasols anchored to a single support.





DE

Entwicklung des Einzelschirmes Astro mit innovativem Öffnungs- und Schliess-System mit Unterstützung von einer Gasfeder. Einziehbares Gestell, das das Öffnen und Schliessen über Tische und Stühle ermöglicht, ohne die Möbel umzuräumen. Geeignet für alle Umgebungen und empfohlen für einen gewerblichen Einsatz (Bars, Restaurants, Hotels und Terrassen) Aluminiumgestell mit Holzeffekt. Starkes Gestell, bestehend aus 4 Sonnenschirmen, die an einem Mast verankert sind.

ES

Evolución del parasol individual Astro con el nuevo sistema de apertura y cierre mediante pistón de gas. Estructura retráctil que permite abrir y cerrar el parasol por encima de las sillas y las mesas sin necesidad de apartar el mobiliario. Adecuado para todos los ambientes y recomendado para uso profesional (bar, restaurantes, hoteles y espacios exteriores). Estructura de aluminio y acabado efecto madera con tratamiento resistente al agua salina y a la degradación por los rayos uv. Acabado novedoso y muy apreciado en el sector outdoor. Estructura robusta compuesta por 4 parasoles soportados por un único palo.

FR

Parasol quadruple avec système innovant d'ouverture et de fermeture assisté par ressort à gaz. Structure rétractable qui permet d'ouvrir et de fermer le parasol au-dessus des tables et des chaises sans avoir à déplacer le mobilier. Convient à tous les environnements et recommandé pour un usage professionnel (bars, restaurants, collectivités, chr...). Cadre en aluminium effet bois. Traitement résistant à l'eau salée et à la dégradation par les uv. Structure robuste composée de 4 parasols accrochés à un seul mat.

NL

Evolutie van de enkele parasol Astro met innovatief openings- en sluitsysteem ondersteund door een gasveer. Intrekbaar naar de mast met systeem dat openen en sluiten boven tafels en stoelen mogelijk maakt zonder het meubilair te verplaatsen. Geschikt voor alle locaties en aanbevolen voor een commerciële toepassing (bars, restaurants, hotels). Met fraai in houtdecor afgewerkt aluminium frame. Ongevoelig voor zout water en uv-degradatie. Sterke constructie bestaande uit 4 parasols verankerd aan een enkele mast.

QUATTRO TITANIUM

Evoluzione dell'ombrellone singolo Astro con innovativo sistema di apertura e chiusura assistito tramite molla a gas. Struttura retrattile che permette apertura e chiusura al di sopra di tavoli e sedie senza dover spostare gli arredi. Adatto per tutti gli ambienti e consigliato per uso professionale (bar, ristoranti, hotel e dehor). Telaio in alluminio con effetto titanium. Struttura robusta composta da 4 ombrelloni ancorati ad un unico sostegno.

EN

Evolution of the single Astro umbrella with innovative Gas piston assisted opening and closing system. Retractable structure that allows opening and closing above tables and chairs without having to move furniture. Suitable for all environments and recommended for Professional applications (bars, restaurants, hotels and outdoor areas). Aluminum frame with titanium effect. Sturdy structure consisting of 4 umbrellas anchored to a single support.



*DE*

Entwicklung des Einzelschirmes Astro mit innovativem Öffnungs- und Schliess-System mit Unterstützung von einer Gasfeder. Einziehbares Gestell, das das Öffnen und Schliessen über Tische und Stühle ermöglicht, ohne die Möbel umzuräumen. Geeignet für alle Umgebungen und empfohlen für einen gewerblichen Einsatz (Bars, Restaurants, Hotels und Terrassen) Aluminiumgestell mit Titanium-Effekt. Starkes Gestell, bestehend aus 4 Sonnenschirmen, die an einem Mast verankert sind.

FR

Evolution du parasol simple Astro avec système innovant d'ouverture et de fermeture assistée par un ressort à gaz. Structure rétractable qui permet d'ouvrir et de fermer au-dessus des tables et des chaises sans déplacer le mobilier. Adapté à tous les environnements et recommandé pour un usage professionnel (bars, restaurants, hôtels et espaces extérieurs). Structure en aluminium effet Titane. Structure robuste composée par 4 parasols fixés à un seul support.

ES

Evolución del parasol individual Astro con innovador sistema de apertura y cierre asistido por resorte de gas. Estructura retráctil que permite abrir y cerrar encima de mesas y sillas sin mover el mobiliario. Apto para todos los ambientes y recomendado para uso profesional (bares, restaurantes, hoteles y zonas exteriores). Estructura de aluminio con efecto Titanio. Robusta estructura formada por 4 sombrillas unidas por un solo soporte.

NL

Evolutie van de Astro parasol met innovatieve gasveer voor openen en sluiten. Intrekbaar frame dat openen en sluiten boven tafels en stoelen mogelijk maakt zonder het meubilair te verplaatsen. Geschikt voor alle omgevingen en aanbevolen voor professioneel gebruik (bars, restaurants, hotels en terrassen). Aluminium frame met titanium-look. Stevig frame bestaande uit 4 parasols verankerd aan één enkele mast.

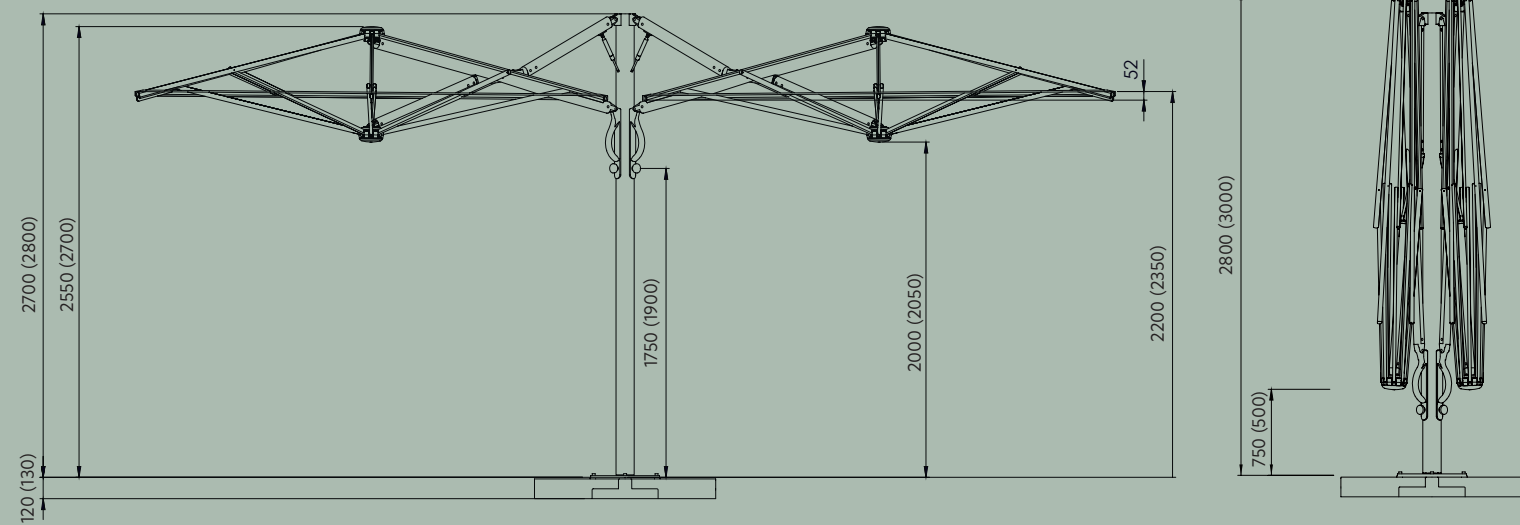
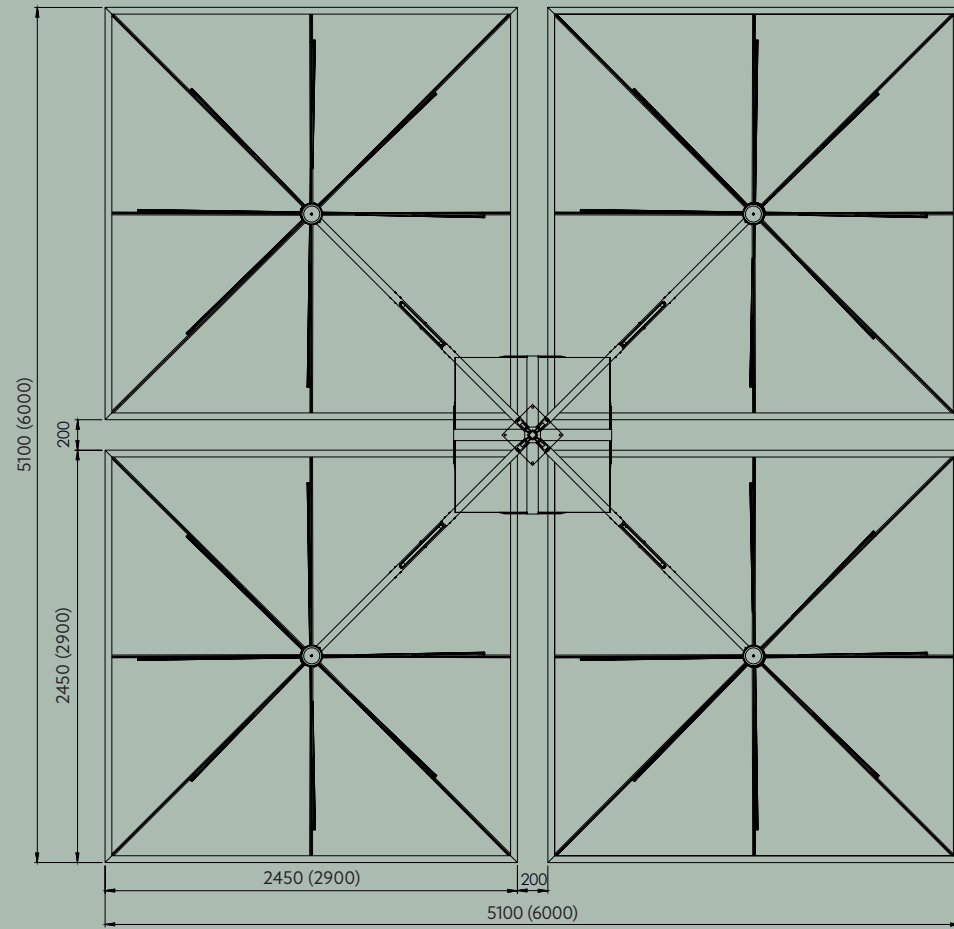

CHARACTERISTICS

		KG	M ³			
5,0x5,0	CARBON C5050 DVC	145	0,80	110x110	8	18x30
	STARWHITE C5050 DVW					
6,0x6,0	CARBON C6060 QUC	170	0,80	110x110	8	18x30
	STARWHITE C6060 QUW					
	TIMBER C6060 QUL					
	TITANIUM C6060 QUT					

OPTIONAL

		BASES p. 100	BALLAST p. 103	GROUND FIXING p. 104
5,0x5,0	CARBON C5050 DVC	PL1DS	BUD8080DS	BTBS
	STARWHITE C5050 DVW	PL1BS	BUD8080BS	
6,0x6,0	CARBON C6060 QUC	PL1DS	BUD8080DS	BTBS
	STARWHITE C6060 QUW	PL1BS	BUD8080BS	
	TIMBER C6060 QUL	PL1DS	BUD8080DS	
	TITANIUM C6060 QUT	PL1DS	BUD8080DS	

Base non compresa nel prezzo | Base not included in the price

FINISHING

- Camino antivento
Wind cap
- Stecca con sistema "easy change"
Ribs with "easy change" system
- INOX** • Viteria in inox
Screws in Stainless steel
- Sistema retrattile
Retractable system
- Apertura con molla a gas
Gas spring opening
- Carbon
• Starwhite
• Timber
• Titanium

COLOUR RANGE - p. 110
ACRILYC 350GR



ROMEO

Forma e design essenziale: una proposta ideata per le esigenze della ristorazione. Linee regolari ma eleganti con la massima versatilità per valorizzare spazi prima inutilizzati. Struttura in acciaio zincato e verniciato, adatto per tutte le stagioni. Con calamita per un facile e veloce accoppiamento.



EN
Essential shape and design: a proposal developed for the demands of the HORECA sector. Regular yet elegant lines with maximum versatility to enhance unused spaces. Galvanized and painted steel frame, suitable for all seasons. With magnet for quick and easy coupling. Available in dark and Starwhite finish.



DE
Minimale Form und Design: geeignet fuer den Gastronomiebedarf. Regelmässige, aber elegante Linien mit maximaler Vielseitigkeit, um bisher ungenutzte Raeume aufzuwerten. Struktur aus verzinktem und lackiertem Stahl, fuer alle Jahreszeiten geeignet. Mit Magnet fuer ein schnelles und einfaches Zusammenstellen.

FR
Forme et design essentiels : une proposition conçue pour les besoins de la restauration. Des lignes régulières mais élégantes avec une polyvalence maximale pour mettre en valeur des espaces auparavant inutilisés. Structure en acier galvanisé et vernis, adaptée à toutes les saisons. Avec aimant pour un appairage rapide et facile. Disponible en finitions Anthracite et Starwhite.

ES
Forma y design esenciales: una propuesta pensada para las necesidades de restauración. Líneas regulares pero elegantes con la máxima versatilidad para realzar espacios no utilizados anteriormente. Estructura de acero galvanizado y pintado, apta para todas las estaciones. Con imán para un emparejamiento rápido y sencillo. Disponible en acabado Antracita y Starwhite.

NL
Minimalistisch design: een tafel ontworpen voor de behoeften vanuit de horeca. Strakke, elegante lijnen met maximale veelzijdigheid om de capaciteit onder de parasol te verbeteren. Gegalvaniseerde en gelakte stalen structuur, geschikt voor alle seizoenen. Met magneet voor snelle en eenvoudige koppeling.

CHARACTERISTIC

	↑ ↓	KG
DARK T75D	1200 x 600 x 750	38 Kg
STARWHITE T75W		

COLOUR RANGE

- Antracite
Dark
- Bianco
Starwhite

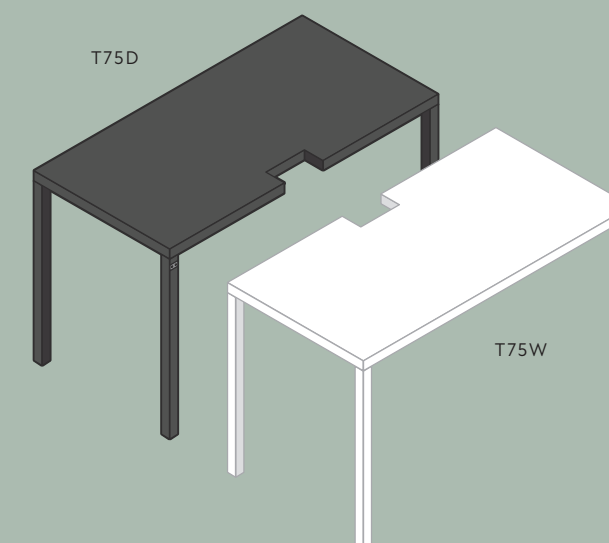

GIULIETTA

Pratica e robusta, un contributo per tutti i dehor. Sfrutta l'area di ingombro della base trasformandola in un'ulteriore zona di seduta e rendendo l'ombrellone utilizzabile per tutta la sua superficie. Struttura in acciaio zincato e verniciato. Con calamita per un facile e veloce accoppiamento.



EN
Practical and sturdy, a useful contribution to all patios. Capitalizes the footprint area of the base by transforming it into an additional seating area and making the umbrella operable for its entire surface area. Galvanized and painted steel frame, suitable for all seasons. With magnet for quick and easy coupling. Available in dark and starwhite finish.

DE
Vielseitig und stark, geeignet fuer alle Aussenbereiche. Die Flaechе des Staenders wird genutzt und in eine zusaetzliche Sitzflaeche verwandelt. Somit ist der Schirm auf seiner gesamten Flaechе nutzbar. Gestell aus verzinktem und lackiertem Stahl. Mit Magnet fuer ein schnelles und einfaches Zusammenstellen.

FR
Pratique et robuste, un apport pour tous les espaces extérieurs. Profitez de la surface encombrante de la base en la transformant en un coin salon supplémentaire et en rendant le parasol utilisable sur toute sa surface. Structure en acier galvanisé et vernis. Avec aimant pour un appairage rapide et facile. Disponible en finitions Anthracite et Starwhite.

ES
Práctico y robusto, un aporte para todos los espacios exteriores. Aprovecha la voluminosa zona de la base transformándola en una zona de asiento adicional y haciendo que la sombrilla sea utilizable en toda su superficie. Estructura de acero galvanizado y pintado. Con imán para un emparejamiento rápido y sencillo. Disponible en acabado Antracita y Starwhite.

NL
Praktisch en stevig, een aanwinst voor elk terras. Het maakt gebruik van de parasolvoet door er een extra zitplek van te maken en de parasol te benutten over het hele oppervlak. Gegalvaniseerd en gelakt stalen structuur. Met magneet voor snelle en eenvoudige koppeling.

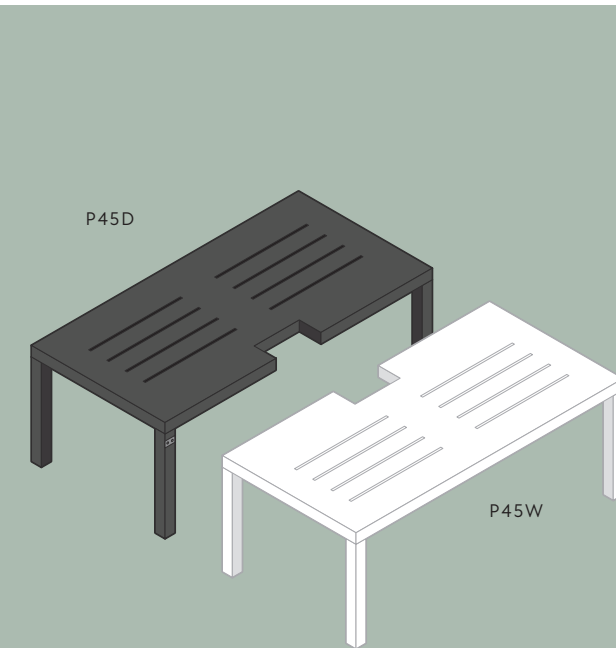

CHARACTERISTIC

		↑ ↓	KG
DARK P45D	1200 x 600 x 450	↓	18 Kg
STARWHITE P45W			

COLOUR RANGE

- Antracite Dark
- Bianco Starwhite

OPTIONAL CROSS METAL BASES

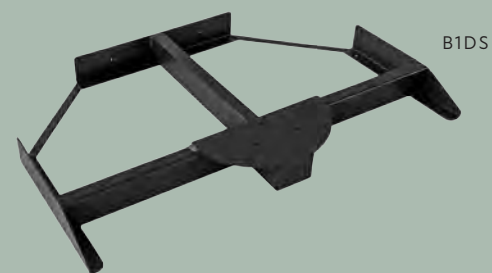

B1DS

B1DS - B1BS

- Base metallica opzionale per ombrelloni a braccio laterale.
- Optional metal base for side arm parasols.
- Optionaler Metallstaender fuer Ampelschirme.
- Base en métal en option pour parasols à bras deporté.
- Base de metal opcional para sombrillas de brazos laterales.
- Optionele metalen voet voor zijarmparaplu's.



KG

B1DS	1070x710x85 mm	15 Kg
B1BS		

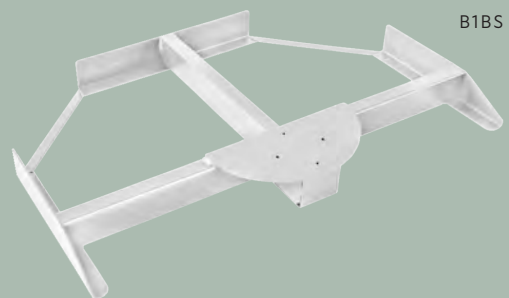

B1BS

PL1DS - PL1BS

- Base a croce metallica opzionale per ombrelloni a braccio laterale.
- Optional cross metal base for side arm parasols.
- Optionaler Kreuz-Metallstaender fuer Ampelschirme.
- Base croix en métal en option pour parasols à bras deporté.
- Base cruz de metal opcional para sombrillas de brazos laterales.
- Optionele kruis metalen voet voor zijarmparaplu's.



KG

PL1DS	1090x1090x130 mm	22 Kg
PL1BS		



PL1DS



PL1BS

CARTER

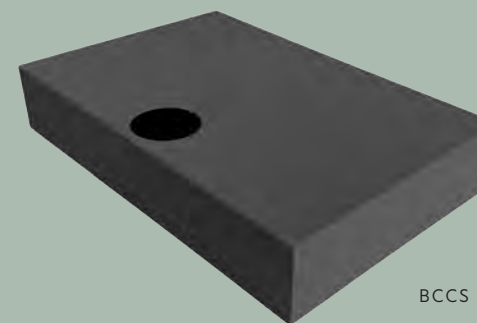

BCCS

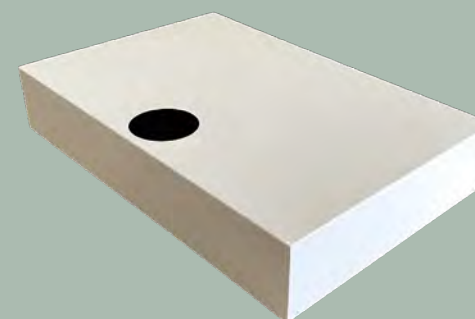

BCWS

BCCS - BCWS

- Carter acciaio zincato e verniciato a polveri. Colori disponibili Dark-Starwhite. Compatibile con base B1DS-B1BS-B1IS.
- Zincated and epoxy coated steel carter. Available colors Dark-Starwhite. Compatible with base B1DS-B1BS-B1IS.
- Verzinkter und pulverbeschichteter Stahlcarter. Erhaeltliche Farben Dark-Starwhite. Kompatibel mit Staender B1DS-B1BS-B1IS.
- Carter acier galvanisé et vernis. Couleurs disponibles Dark-Starwhite. Compatible avec socle B1DS-B1BS-B1IS.
- Carter de acero galvanizado y pintado. Colores disponibles Dark-Starwhite. Compatible con base B1DS-B1BS-B1IS.
- Gegalvaniseerd en geepoxeerde metaalcarter. Beschikbare kleuren Dark-Starwhite. Compatibel met basis B1DS-B1BS-B1IS.



KG

BCCS	1100x720x200 mm	18 Kg
BCWS		

BDCS - BDWS

- Carter acciaio zincato e verniciato a polveri. Colori disponibili Dark-Starwhite. Compatibile con base PL1DS-PL1BS.
- Zincated and epoxy coated steel carter. Available colors Dark-Starwhite. Compatible with base PL1DS-PL1BS.
- Verzinkter und pulverbeschichteter Stahlcarter. Erhaeltliche Farben Dark-Starwhite. Kompatibel mit Staender PL1DS-PL1BS.
- Carter acier galvanisé et vernis. Couleurs disponibles Dark-Starwhite. Compatible avec socle PL1DS-PL1BS.
- Carter de acero galvanizado y pintado. Colores disponibles Dark-Starwhite. Compatible con base PL1DS-PL1BS.
- Gegalvaniseerd en geepoxeerde metaalcarter. Beschikbare kleuren Dark-Starwhite. Compatibel met basis PL1DS-PL1BS.



KG

BDCS	1130x1130x120 mm	21 Kg
BDWS		

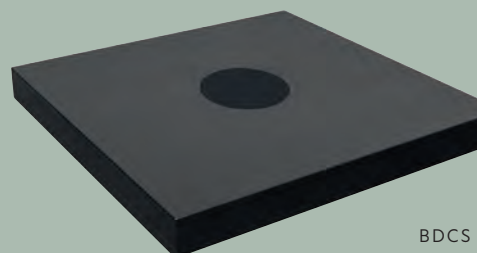

BDWS

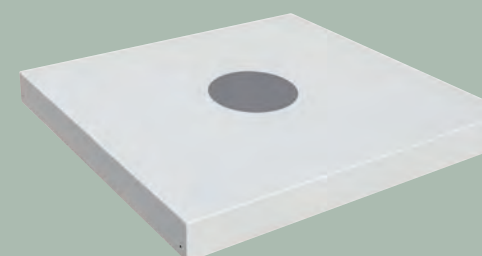

BDCS

Pag. 99

con zavorre
Available ballasts / Verfüegbarer Ballast /
Ballasts disponibles / Losas disponibles /
Beschikbare ballasten

Pag. 102

schema di stabilità
see stability diagram / Stabilitaetsdiagramm /
diagramme de stabilité / diagrama de estabilidad /
stabiliteitsdiagram

Da completare:
To be completed / Ballast ergaenzen /
A compléter avec ballasts / Completar con losas /
Aan te vullen met voorschakelapparaten

OPTIONAL CROSS METAL BASES

BDC8080

- Carter acciaio zincato e verniciato a polveri. Colori disponibili Dark-Starwhite. Compatibile con base BUD8080.
- Zincated and epoxy coated steel carter. Available colors Dark-Starwhite. Suitable for base BUD8080.
- Verzinkter und pulverbeschichteter Stahlcarter. Erhältliche Farben Dark-Starwhite. Kombinierbar mit Staender BUD8080.
- Carter acier galvanisé et vernis. Couleurs disponibles Dark-Starwhite. Combinable avec pied BUD8080.
- Carter de acero galvanizado y pintado. Colores disponibles Dark-Starwhite. Combinable con base BUD8080.
- Gegalaniseerd en geepoexeerde metaalcarter. Beschikbare kleuren Dark-Starwhite. Combineerbaar met parasolvoet BUD8080.



BDC8080DS	890x890x140 mm	21 Kg
BDC8080BS		

BUD8080

- Base a croce metallica opzionale per ombrellone a braccio da completare con 12 BC4040, non comprese. Compatibile con kit ruote B8080R.
- Optional cross metal base for cantilever parasols to be completed with 12 BC4040, not included. Compatible with wheel kit B8080R.
- Alternativer Stahlplattenstaender fuer Seitenarmschirme zum kombinieren mit 12 BC4040, nicht inbegriffen. Kompatibel mit Rollen B8080R.
- Pied en acier optionnelle pour parasols bras deporté à combiner avec 12 BC4040, non inclus. Compatible avec kit roulettes B8080R.
- Base de metal opcional para sombrillas brazo lateral para completar con 12 BC4040, no incluido. Compatible con juego de ruedas B8080R.
- Optionele metalen basis voor arm parasol uit te voeren met 12 BC4040, niet inbegrepen. Compatibel met wielkit B8080R.



BUD8080DS	890x890x140 mm	32 Kg
BUD8080BS		

B8080R

- Kit ruote alta resistenza girevoli e frenanti.
- High resistance rotating and braking wheels kit.
- Hochwiderstands-dreh- und bremsrad set.
- Kit roues rotatives et freinage haute résistance.
- Kit ruedas giratorias y frenos de alta resistenci.
- Kit met hoge weerstand draaiende en remwielen.



BALLAST

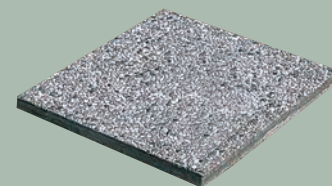

		KG
BC4040	400x400 mm	14 Kg
BC5050	500x500 mm	20 Kg

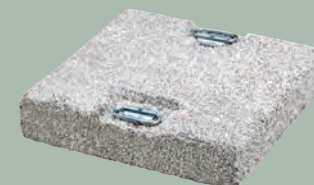

		KG
BC5151	500x500 mm	60 kg



		KG
BC5151G	500x500 mm	60 kg



		H	KG
BV5050G	500x500 mm	270 mm	80 kg



		H	KG
BV5050B	500x500 mm	270 mm	80 kg

BC4040 - BC5050

- Piastra in cemento e graniglia. Spessore 4 cm.
- Cement grit slab. Thickness 4 cm.
- Kiesbetonplatte. Dicke 4 cm.
- Dalles ciment et grès. Epaisseur 4 cm.
- Planchas de hormigón y de grava. De espesor 4 cm.
- Gewassen grindtegel. Dikte 4 cm.

BC5151

- Piastra in cemento e graniglia bianca con maniglie. Spessore 11cm. Per ombrelloni a braccio.
- White cement grit slab with handles. Thickness 11cm. For cantilever parasols.
- Weisse Kiesbetonplatte mit Handgriffen. Dicke 11cm. Fuer Pendelschirme.
- Dalles ciment et grès avec poignées blanc. Epaisseur 11cm. Pour parasols avec bras deporté.
- Placas blancas de hormigón y arena con asas. De espesor 11 cm. Para parasoles con voladizo.
- Wit gewassen grindtegel met handgrepen. Dikte 11 cm. Geschikt voor vrijhangende parasols.

BC5151G

- Piastra in cemento grigio con maniglie. Spessore 11cm. Per ombrelloni a braccio.
- Concrete grey cement slab with handles. Thickness 11cm. For cantilever parasols.
- Grauer Betonplatte mit Handgriffen. Dicke 11cm. Fuer Pendelschirme.
- Dalles ciment couleur gris avec poignées. Epaisseur 11cm. Pour parasols avec bras deporté.
- Base de cemento gris con asas. De espesor 11 cm. Para parasoles con voladizo.
- Betontegel grijs met handgrepen. Dikte 11 cm. Geschikt voor vrijhangende parasols.

BV5050G

- Vaso in cemento grigio con maniglie. Spessore 11cm. Per ombrelloni a braccio.
- Concrete grey cement pot with handles. Thickness 11cm. For cantilever parasols.
- Grauer Betontopf mit Handgriffen. Dicke 11cm. Fuer Pendelschirme.
- Vase ciment couleur gris avec poignées. Epaisseur 11cm. Pour parasols avec bras deporté.
- Maceta de cemento gris con asas. De espesor 11 cm. Para parasoles con voladizo.
- Plantenschaal grijs met handgrepen. Dikte 11 cm. Geschikt voor vrijhangende parasols.

BV5050B

- Vaso in cemento bianco con maniglie. Spessore 11cm. Per ombrelloni a braccio.
- Concrete white cement pot with handles. Thickness 11cm. For cantilever parasols.
- Weisser Betontopf mit Handgriffen. Dicke 11cm. Fuer Pendelschirme.
- Vase ciment couleur blanc avec poignées. Epaisseur 11cm. Pour parasols avec bras deporté.
- Maceta de cerámica con asas de hormigón. De espesor 11 cm. Para parasoles con voladizo.
- Plantenschaal beton met handgrepen. Dikte 11 cm. Geschikt voor vrijhangende parasols.

GROUND FIXING

CP3030ZS

- Contropiastra acciaio zincato per fissaggio a terra. 30x30 cm.
- Small metal plate for concrete ground fixation. 30x30 cm.
- Verzinkte Stahlplatte fuer Bodenbefestigung. 30x30 cm.
- Contreplaque acier galvanise pour ancrage au sol. 30x30 cm.
- Placa acero galvanizado fijación a tierra. 30x30 cm.
- Metaal zinkplaat voor grondbevestiging. 30x30 cm.



CP3030ZS	300x300 mm	7 Kg
----------	------------	------

CP6565ZS

- Contropiastra acciaio zincato per fissaggio a terra. 65x65 cm.
- Metal plate for concrete ground fixation. 65x65 cm.
- Verzinkte Stahlplatte fuer Bodenbefestigung. 65x65 cm.
- Contreplaque acier galvanise pour ancrage au sol. 65x65 cm.
- Placa acero galvanizado fijación a tierra. 65x65 cm.
- Metaal zinkplaat voor grondbevestiging. 65x65 cm.



CP6565ZS	650x650 mm	30 kg
----------	------------	-------

BTBS

- Supporto da interrare. acciaio zincato.
- In ground anchor. zinced steel.
- Bodenanker. Verzinktes stahl.
- Base pour ancrage au sol. acier galvanisé.
- Base para fijación a tierra. acero galvanizado.
- Grondanker. gegalvaniseerd staal.



BTBS	300x300 mm	10 kg
------	------------	-------

BTAS

- Supporto da interrare. Acciaio inox.
- In ground anchor. Stainless steel.
- Bodenanker. Edelstahl.
- Base pour ancrage au sol. Acier inoxydable.
- Base para fijación a tierra. Acero inoxidable.
- Grondanker. Roestvrij staal.

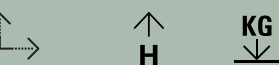

BTAS	Ø 160 mm	350 mm	5 kg
------	----------	--------	------

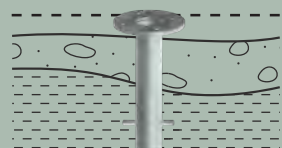
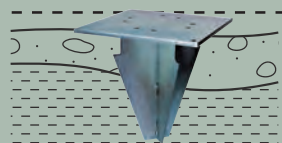
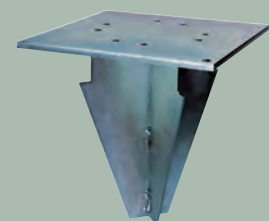



La base e l'eventuale zavorra sono fondamentali per garantire stabilità e sicurezza. Selezionare l'opzione adeguata al momento dell'ordine. In caso di fissaggio a terra si esclude il rischio di ribaltamento dell'ombrellone, ma non il cedimento strutturale di alcuni componenti se sottoposti a condizioni atmosferiche incompatibili con l'uso dei ns prodotti. Queste tabelle sono indicative e prevedono che il pavimento o il terreno di appoggio sia perfettamente piano e regolare. Gli ombrelloni e i rispettivi componenti delle basi devono essere assemblati correttamente rispettando le istruzioni di montaggio. La stabilità degli ombrelloni può variare nel caso di condizioni atmosferiche particolari. L'utilizzatore finale è responsabile del corretto uso dell'ombrellone. Nessuna rivalsa può essere fatta sul produttore.

EN

The base and any ballast are essential to ensure stability and safety. Please select the appropriate option when ordering. In case of ground fixation, the risk of overturning of the parasol is excluded, but not the structural failure of some components, if subjected to atmospheric conditions that are incompatible with the use of our products. This schedule considers statics calculation and foresees that the floor where the parasol has to be positioned is perfectly flat and regular. The parasols and components have to be assembled correctly and respecting the assembly instruction. The schedule has to be considered indicative because many variables that depend from the area of employ and position of the parasols are not foreseeable. No rights can be derived from this. The use of a parasol is always on your own responsibility.



DE

Der Staender und eventueller Ballast sind grundlegend um Stabilitaet und Sicherheit zu gewaehrleisten. Bitte waehlen Sie bei der Bestellung die entsprechende Option aus.

Bei Bodenbefestigung ist das Risiko des Umkippens des Schirms ausgeschlossen, aber nicht das strukturelle Versagen einiger Bestandteile, wenn es atmosphärischen Bedingungen ausgesetzt wird, die mit der Verwendung unserer Produkte nicht vereinbar sind. Diese Aufstellung beinhaltet statistische Kalkulationen und sieht vor, dass der Schirm auf einem ebenen und regemaessigen Boden positioniert wird. Der Schirm und die Bestandteile des Staenders muessen gemaess Anbauanleitungen montiert werden. Die Stabilitaet der Schirme kann auf Grund besonderer klimatischen Konditionen aendern. Der Endbenutzer ist fuer die ordnungsgemaesse Verwendung des Schirmes verantwortlich.

FR

La base et les eventuels poids sont essentiels pour assurer la stabilité et la sécurité. Svpl. sélectionnez l'option appropriée lors de la commande. En cas de fixation au sol, le risque de renversement du parasol est exclu, mais pas la défaillance structurelle de certains composants s'ils sont soumis à des conditions atmosphériques incompatibles avec l'utilisation de nos produits. Ces tableaux sont à titre indicatif et ils prévoient que la surface sur laquelle est implanté le parasol soit parfaitement plane et lisse. Les parasols et les éléments respectifs des bases doivent être assemblés en respectant scrupuleusement les instructions de montage. La stabilité des parasols peut varier dans le cas de conditions atmosphériques particulières et dépend du lieu et de l'utilisation propre à chaque utilisateur (le parasol doit être fermé en cas de vent fort et/ou de mauvaises conditions météorologiques).

ES

La base y posible balasto son fundamentales para garantizar la estabilidad y la seguridad. Seleccione la opción adecuada al realizar el pedido. En caso de fijación al suelo, se excluye el riesgo de vuelco del parasol, pero no el fallo estructural de algunos componentes si se someten a condiciones atmosféricas incompatibles con el uso de nuestros productos. Estos cuadros son indicativos y requieren que el suelo o el apoyo de tierra sea perfectamente plano y liso. El parasol y los respectivos componentes de la base deben ser montados correctamente respetando las instrucciones. La estabilidad de los parasoles puede variar según las condiciones atmosféricas.

NL

Basis en eventuele ballast zijn essentieel om stabiliteit en veiligheid te garanderen. Selecteer alstublieft de juiste optie bij het bestellen. In het geval van bevestiging aan de grond is het risico dat de parasol omvalt uitgesloten, maar niet het structurele falen van sommige onderdelen als ze worden blootgesteld aan atmosferische omstandigheden die onverenigbaar zijn met het gebruik van onze producten. This schedule considers statics calculation and foresees that the floor where the parasol has to be positioned is perfectly flat and regular. The parasols and components have to be assembled correctly and respecting the assembly instruction. The schedule has to be considered indicative because many variables that depend from the area of employ and position of the parasols are not foreseeable.

	B1									PL1			BUD8080				GROUND FIXING			
	3,0 x 3,0	◆	/	3	2	◆	4	5			◆	3	⚠		5	5	/	5		
ASTRO	3,5 x 3,5	◆	/	3	1	+12 BC5050	◆	3	4	+12 BC5050	◆	2	⚠	+12 BC4040	5	5	/	5		
	3,0 x 4,0	◆	/	2	1		◆	3	4		◆	2	⚠		5	5	/	5		
DUALT	3,0 x 6,0	/	/	/	/	◆	3	4		+12 BC5050	◆	2	⚠	+12 BC4040	/	5	5	/		
	3,5 x 7,0	/	/	/	/	◆	2	3			◆	/	⚠		/	5	5	/		
DUALV	2,5 x 5,0	/	/	/	/	◆	4	5		+12 BC5050	◆	3	⚠	+12 BC4040	/	5	5	/		
	3,0 x 6,0	/	/	/	/	◆	3	4		+12 BC5050	◆	2	⚠	+12 BC4040	/	5	5	/		
QUATTRO	5,0 x 5,0	/	/	/	/	◆	3	4		+12 BC5050	◆	2	⚠	+12 BC4040	/	5	5	/		
	6,0 x 6,0	/	/	/	/	◆	2	3		+12 BC5050	◆	1	⚠	+12 BC4040	/	5	5	/		



- In caso di base con ruote, prestare particolare attenzione in caso di vento. Prima di spostare l'ombrellone è necessario chiuderlo.
- In case of base with wheels, be especially careful in windy conditions. Close the parasol before moving it.
- Bei Staender mit Raeder und Wind besonders vorsichtig sein. Der Schirm kann geschlossen bewegt werden.
- Dans le cas d'une base à roues, faites particulièrement attention par temps venteux. Avant de déplacer le parasol, il est nécessaire de le fermer.
- En el caso de una base con ruedas, tenga especial cuidado en condiciones de viento. Antes de mover la sombrilla es necesario cerrarlo.
- Wees vooral voorzichtig met statieven met wielen en wind. De parasol kan in gesloten toestand worden verplaatst.



- Peso minimo richiesto
- Minimum required weight
- Erforderliches Mindestgewicht
- Poids minimum requis
- Peso mínimo requerido
- Minimaal vereist gewicht



- Stabilità intermedia
- Intermediate stability
- Mittlere Stabilität
- Stabilité intermédiaire
- Estabilidad intermedia
- Gemiddelde stabiliteit



- Peso consigliato in condizioni normali
- Recommended weight under normal conditions
- Empfohlenes Gewicht unter normalen Bedingungen
- Poids recommandé dans des conditions normales
- Peso recomendado en condiciones normales
- Aanbevolen gewicht onder normale omstandigheden



- Massima stabilità con base
- Maximum stability with base
- Maximale Stabilität mit Staender
- Stabilité maximale avec socle
- Máxima estabilidad con base
- Maximale stabiliteit met voet



- Massima stabilità con fissaggio a terra
- Maximum stability with ground fixation
- Maximale Stabilität bei Bodenbefestigung
- Stabilité maximale avec fixation au sol
- Máxima estabilidad con fijación al suelo
- Maximale stabiliteit door bodembevestiging

FABRIC COLLECTION



FATTORE DI PROTEZIONE SOLARE
Limita il passaggio del calore per più del 70%.

SOLAR PROTECTION FACTOR
Harmful UV rays and limiting heat circulation



FATTORE DI PROTEZIONE LUMINOSA
Indica la percentuale di trasmissione della luce

FACTOR OF SOLAR LIGHT PROTECTION
% of light trasmission



FATTORE DI PROTEZIONE UPF
Protezione dai raggi U.V. (UPF) dal 85% al 100%

UPF PROTECTION FACTOR
Harmful UV rays. (UPF) from 85% almost 100%

SCHEDA TECNICA / DATA SHEET

COMPOSIZIONE / COMPOSITION	CARATTERISTICHE / FINISHING	SOLIDITÀ AL COLORE / COLOR FASTNESS	TRATTAMENTO / TREATMENT	IMPERMEABILITÀ / COLONNA D'ACQUA / IMPERMEABILITY / WATER COLUMN
350 gr/m ² 100% acryl	Inattaccabile da muffe e batteri. Solido alla luce Permeabile all'aria Antimacchia - Resistant to mould and bacteria. Solid to light Air permeable Stain resistant	Grado 7/8 ensio 105-b04 - Grade 7/8 ensio 105-b04	Resine teflon idro-oleorepellenza - Teflon resins water-oil repellent	circa 25 cm - about 25cm

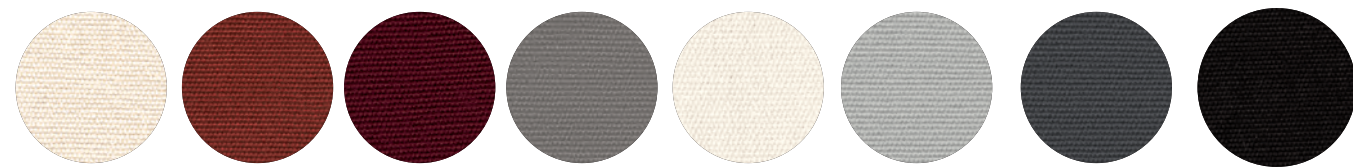

350 GR/M ² ACRYLIC	A1 ECRU NATURAL COL. NATUR	T2 TERRACOTTA ZIEGELROT TERRACOTTA	T3 BORDEAUX	T6 GRIGIO TAUPE GREY TAUPE GRAU TAUPE GRIS TAUPE GRIJS TAUPE	T7 BIANCO WHITE BLANC WEISS	T8 GRIGIO PERLA SILVER GREY SILBERGRAU	T9 GRIGIO ANTRACITE ANTHRACIT GREY ANTHRAZITGRAU	S1 NERO /BLACK SCHWARZ NOIRE NEGRO ZWART
-------------------------------	-------------------------------------	---	----------------	--	---	---	--	---

	70/80%	> 90%	> 90%	> 90%	70/80%	> 90%	> 90%	> 90%
	20/30%	< 10%	< 10%	< 10%	20/30%	< 10%	< 10%	< 10%
UPF	85/89%	100%	100%	100%	85/89%	100%	100%	100%

I dati forniti, pur essendo frutto di misurazioni scientifiche condotte in laboratori certificati, sono da ritenersi indicativi.
The above mentioned data are indicative, although provided by scientific measurements performed in certified laboratories.



EXCLUSIVE FABRIC COLLECTION

350GR/M² ACRYLIC

- Gamma tessuti a richiesta. Tessuto mano tende.
- Fabric range on request. Awning fabrics.
- Farbkollektion auf Anfrage. Markisenstoffe.
- Gama de telas bajo pedido. Telas de toldos.
- Kleurencollectie op aanvraag. Zonweringdoek.



> 90%



< 10%



100%

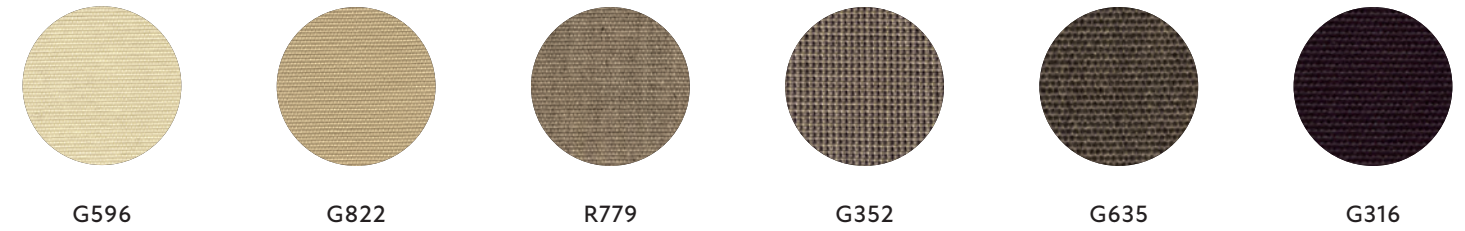

G596

G822

R779

G352

G635

G316

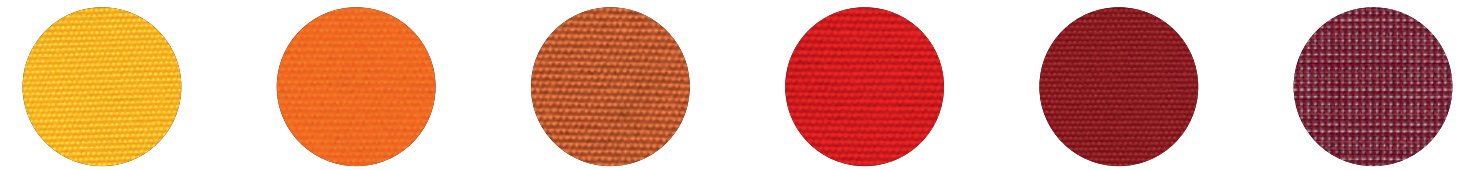

G013

G050

R777

G211

G209

G055

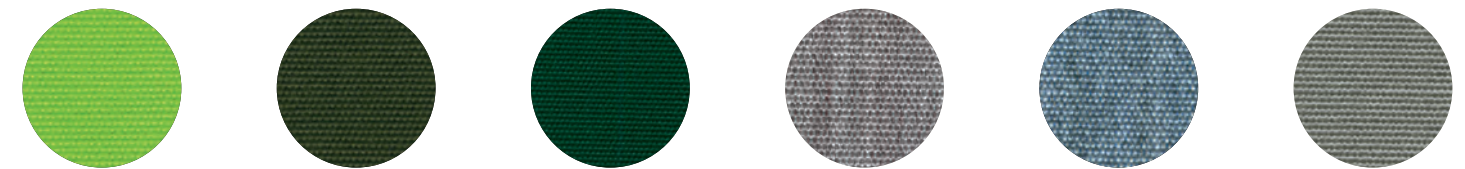

G024

R023

G245

G365

G636

G396

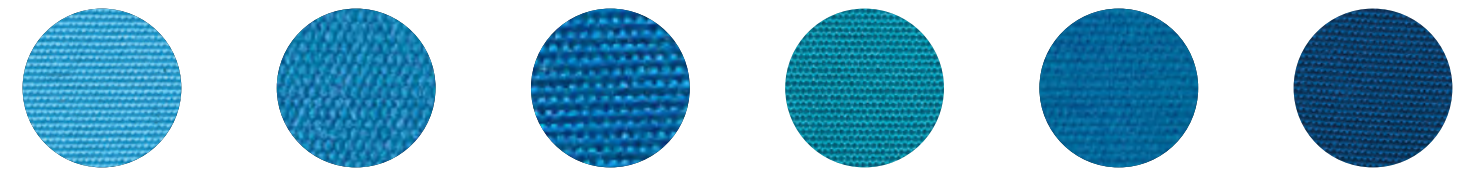

G066

G216

G189

G329

G204

G235

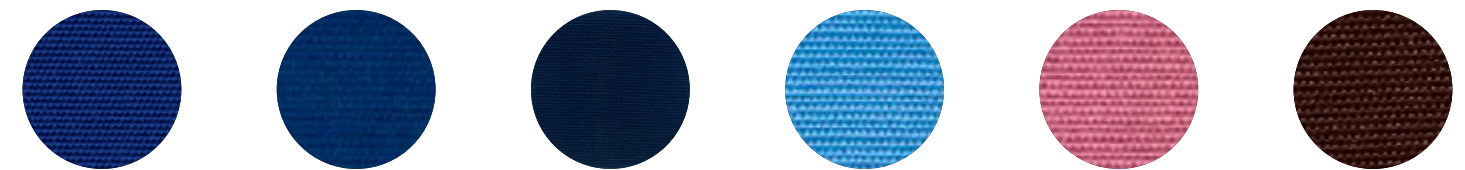

G018

R022

G051

G785

G285

G119

KIT LED GALAXIA

WHITE 3000K



IT

Kit led ad alta luminosità sviluppato per le esigenze del settore professionale. Cablatura ed accessori all'interno del prodotto. Si può applicare ai modelli Astro, DUAL e QUATTRO. Da predisporre in fase di produzione.

Il kit è composto da:

- Circuito luminoso a led integrato nella corona centrale inferiore per utilizzo esterno;
- Luce a led bianca 3000k con telecomando remote control (ON/OFF - dimmer);
- Batteria ricaricabile con autonomia minima di 8 ore, completa di contenitore IP56 e carica batteria;
- In alternativa alimentatore elettronico stabilizzato 220Vac - 12Vdc 60W;
- cablaggio completo per utilizzo in esterno;

EN

Complete high light LED kit developed for a professional and commercial fit. Wiring and accessories inside the product. Suitable for models Astro, DUAL and QUATTRO models. To be prepared during production.

The kit consists of:

- LED light circuit integrated in the lower central crown for external use;
- 3000k white LED light with remote control remote control (ON / OFF - dimmer);
- Rechargeable battery with a minimum autonomy of 8 hours, with IP56 case and battery charger;
- Alternatively 220Vac stabilized electronic power supply - 12Vdc 60W;
- complete wiring for outdoor use;

DESCRIZIONE / DESCRIPTION

	Astro	Dual	Quattro
luce bianca - con collegamento elettrico white light - electrical - connection	KIT.LED.GX.W.C	KIT.LED.GXD.W.C.	KIT.LED.GXQ.W.C.
luce bianca - kit batteria white light - battery kit	KIT.LED.GX.W.B	KIT.LED.GXD.W.B	KIT.LED.GXQ.W.B

B: BATTERIA / BATTERY



CARICA BATTERIA
BATTERY CHARGER

BATTERIA
BATTERY

C: CORRENTE / POWER



ALIMENTATORE 220V
220V POWER SUPPLY



TELECOMANDO IR
REMOTE CONTROL



MATERIALI E FINITURE MATERIALS AND FINISHES

COMPONENTI E PROFILI ALLUMINIO ALUMINIUM COMPONENTS AND PROFILES

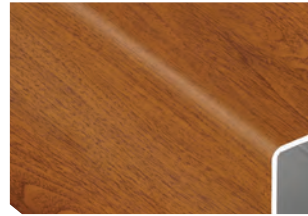

TIMBER

- Astro
- Dual T
- Dual V
- Quattro



CARBON

- Astro
- Dual T
- Dual V
- Quattro



STARWHITE

- Astro
- Dual T
- Dual V
- Quattro



TITANIUM

- Astro
- Dual T
- Dual V
- Quattro

PROFILI STECCHE RIBS PROFILES



TIMBER

- Astro
- Dual T
- Dual V
- Quattro



CARBON

- Astro
- Dual T
- Dual V
- Quattro



STARWHITE

- Astro
- Dual T
- Dual V
- Quattro



TITANIUM

- Astro
- Dual T
- Dual V
- Quattro



Canalina-Raingutter

ACCESSORIES



Cover bag Quattro/Dual

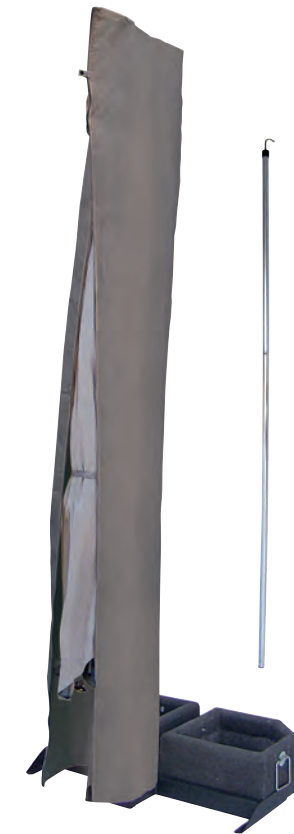

Cover bag Astro

USO E MANUTENZIONE

INDICAZIONI

- Prima dell'uso, conservare e leggere attentamente i manuali e le istruzioni di montaggio che si trovano all'interno della confezione.
- La base deve essere zavorrata. Un peso insufficiente compromette seriamente la stabilità dell'ombrellone.
- Rimuovere sempre la manovella quando non in uso e tenerla fuori dalla portata dei bambini.
- Per evitare danni o lesioni personali, l'ombrellone deve essere chiuso e in alcune condizioni atmosferiche avverse potrebbe essere necessario rimuovere il prodotto e stoccarlo in luogo protetto. Ricorda sempre che l'ombrellone non è una costruzione fissa. La ditta Scolaro non può essere ritenuta responsabile per danni alla merce fornita, o lesioni derivanti da un uso improprio e dal mancato rispetto delle istruzioni e delle linee guida fornite.

IMPIEGO DEL PRODOTTO

Prima di iniziare ad aprire l'ombrellone, assicurarsi che il tessuto non sia rimasto impigliato nelle stecche interne. Per aprire o chiudere l'ombrellone ruotare la maniglia (dove presente) nel senso indicato dalle frecce e dalla scritta "Apri" o "Chiudi". Un funzionamento errato potrebbe strappare la corda o danneggiare il meccanismo. Non forzare mai le corde o maniglie. Se si bloccano, controlla perché è successo ed elimina la possibile causa.

Parti in legno: applicare un impregnante per legno a base di cera almeno una volta all'anno prima della stagione invernale. Chiudere l'ombrellone quando le condizioni meteorologiche non sono adatte, ad es. forte vento o pioggia battente.

Gli ombrelloni Scolaro possono essere abbinati a basi speciali sviluppate per il fissaggio a terra. Qualora si decida di posizionare un ombrellone Scolaro utilizzando solo zavorra, ne viene certificata l'idoneità all'utilizzo in condizioni di vento moderato. Nella tabella specifica sono indicate le zavorre minime. Il Cliente è l'unico responsabile dell'installazione e della gestione dell'ombrellone.

ACCIAIO INOSSIDABILE

Attenzione:

1. NON UTILIZZARE I SEGUENTI PRODOTTI su parti in acciaio inossidabile: Candeggina a base di cloro o detersivi contenenti candeggina (possono corrodere l'acciaio inossidabile). Acido cloridrico o prodotti contenenti cloruri (possono corrodere l'acciaio inossidabile).
2. Il sale, il calcare o gli acidi (bevande e alimenti) possono scolorire le parti in acciaio inossidabile se non pulite tempestivamente.
3. I prodotti o le parti in acciaio inossidabile utilizzati in prossimità del mare o per la decorazione interna delle piscine richiedono una pulizia più frequente per rimuovere i cloriti depositati e per prevenire la corrosione e il deterioramento chimico delle superfici esterne.
4. Macchie o ruggine rilevate sulle superfici in acciaio inossidabile devono essere pulite tempestivamente.
5. Le macchie non rimosse per lunghi periodi possono diventare permanenti.
6. La ruggine può causare reazioni chimiche o corrodere l'acciaio inossidabile.

Per rimuovere macchie o ruggine:

- Applicare un detersivo o lucidante specifico non abrasivo per acciaio inox.
- Sciacquare accuratamente con acqua pulita.
- Infine asciugare bene per evitare che si formino striature, sfregamento nel senso delle fibre.

METALLI VERNICIATI: FERRO E ALLUMINIO

Per una lunga durata dell'ombrellone si consiglia di riporlo in ambienti asciutti, durante il periodo invernale e quando non utilizzato. Si consiglia inoltre di controllare una volta a stagione, soprattutto dopo un lungo periodo di inattività, il corretto funzionamento di tutti i componenti. La nostra garanzia non copre alcun tipo di graffio o abrasione alla finitura causata dal contatto con altri arredi o dalla conseguente corrosione.

L'impiego in ambienti marini può portare all'accumulo di sali e cloruri sulla verniciatura a polvere. La mancata esecuzione di una regolare pulizia con acqua dolce può causare la formazione di bolle, ossidazioni, scolorimento e invalidare la garanzia.

Per la pulizia delle superfici in metallo verniciato utilizzare acqua fredda e detersivi liquidi non abrasivi o aggressivi.

Applicare con un panno morbido. Nel caso di superfici molto sporche e/o invecchiate, dopo la pulizia, si consiglia di trattarle con paraffina liquida. In caso di macchie causate da depositi di calcare su vernici di struttura grossolana (es. ferro antico e marrone d'india) pulirle con uno straccio e una soluzione di aceto di vino bianco diluito in acqua fredda.

LEGNO: IROKO

Legno tradizionale impiegato per l'arredo esterno e l'industria nautica. L'iroko è un legno duro ad alto contenuto di olio, adatto per uso esterno. Estremamente duraturo. È praticamente inalterabile alla ripetuta esposizione agli agenti atmosferici. Anche se trattato, la superficie assume una patina grigio argento che è la naturale protezione dall'interno del legno, considerato parte essenziale del fascino dell'Iroko. La naturale tendenza del legno ad ingrigire o perdere la brillantezza della vernice può essere prevenuta nelle prime fasi di vita del prodotto. L'ombrellone può essere ripristinato mediante un nuovo trattamento con adeguato prodotti facilmente reperibili nei negozi specializzati. È necessario applicare una soluzione di acqua e olio incolore, a superfici esposte con un panno. L'olio deve essere molto diluito. Le macchie superficiali possono essere rimosse intervenendo per tempo, prima che il legno possa assorbirle completamente. Carteggiare delicatamente la superficie in questione e poi lucidare con un panno ruvido.

TESSUTI SINTETICI: ACRILICO E POLIESTERE

Il tessuto è impermeabile e trattato antimuffa per respingere l'acqua, le macchie e garantire la traspirazione. Si prega di seguire le nostre istruzioni di manutenzione per garantire la lunga durata del tessuto:

- Rimuovere spesso depositi di polvere, macchie e qualsiasi tipo di sporco per evitare tracce dopo la pulizia.
- È molto importante chiudere l'ombrellone solo quando è perfettamente asciutto. Durante l'inverno e quando l'ombrellone non viene utilizzato, deve essere conservato in un ambiente asciutto. Evitare il contatto prolungato con sostanze oleose e/o coloranti che potrebbero essere assorbite dal materiale di rivestimento in PVC e causare macchie permanenti, oltre a danneggiare la struttura del filo. Non utilizzare solventi o detersivi a base di solventi (evitare l'acetone). Usare acqua e detersivi liquidi non abrasivi, incolore, a PH neutro. Lasciare agire il detersivo per qualche minuto. Risciacquare bene con acqua non più calda di 30°C.

COMPONENTI

I componenti in acciaio, la viteria e gli accessori sono trattati antiruggine. Comunque per una lunga durata dell'ombrellone, durante l'inverno e quando non viene utilizzato, l'ombrellone deve essere conservato in ambiente asciutto. Durante ogni stagione è necessario verificare la funzionalità di tutti i componenti, soprattutto dopo un lungo periodo di inattività. La ditta Scolaro è a vostra disposizione per assistenza tecnica.

GARANZIA

Gli ombrelloni Scolaro sono progettati per durare molti anni esposti all'uso esterno.

Come per molti articoli, l'attenzione nell'uso e nella manutenzione e il rispetto delle istruzioni contenute in queste pagine, permette una vita media ancora più lunga del prodotto e la possibilità di godere di un prodotto ancora più efficiente ed esteticamente gradevole.

I prodotti Scolaro sono garantiti 2 anni.

Se si rispettano le indicazioni e i consigli, la garanzia può essere estesa come segue:

LA GARANZIA COPRE SOLO I DIFETTI DI FABBRICAZIONE DI INTEGRITÀ STRUTTURALE. LA GARANZIA NON COPRE DANNI CAUSATI DA AZIONI MECCANICHE, FORZA NATURALE E ATTI DOLOSI.

5 anni di garanzia sui componenti in alluminio e acciaio inox. Inclusa verniciatura e viti.

- Difetti strutturali non derivanti da uso improprio o mancata manutenzione.
- Corrosione invasiva non prodotta da graffi o abrasioni da utilizzo non asportabile mediante normale pulizia e manutenzione.

5 anni di garanzia sui colori e sul trattamento dei tessuti (resistenza).

- La sostituzione della coperta durante il periodo di garanzia è prevista solo in caso di scolorimento prima della fine del periodo di garanzia. Gli utenti devono conservare correttamente i tessuti, affinché la garanzia sia effettiva. Una corretta manutenzione implica una pulizia regolare.
- La garanzia non copre i danni da contatto con oggetti estranei, abrasioni causate dal vento, uso improprio o abuso (strappi, bruciature e fori). L'uso intensivo in ambiente aggressivo (mare e piscina), richiede un regolare risciacquo del tessuto con acqua dolce per prevenire ed evitare l'accumulo di residui salini e clorurati.

2 anni di garanzia su tutti gli elementi metallici e in acciaio in genere

2 anni di garanzia in genere per le finiture e altri materiali non specificatamente menzionati e scritti sopra, comprese le basi in cemento le zavorre

1 anno di garanzia sui kit luci LED e sui componenti elettrici in general.

LA GARANZIA NON SI APPLICA:

- Se il prodotto non è stato assemblato secondo le istruzioni fornite;
- in caso di uso improprio del prodotto o non conforme alla normale destinazione d'uso del bene;

- in caso di mancato rispetto delle istruzioni per l'uso e la manutenzione indicate nel materiale informativo fornito con il prodotto;
- in caso di stoccaggio in condizioni ambientali non idonee al prodotto;
- in caso di modifica o manomissione del prodotto;
- se il prodotto è stato assemblato o combinato con componenti e prodotti non forniti da Scolaro.

Per usufruire della garanzia è necessario esibire l'articolo difettoso o inviare le foto, unitamente alla fattura o scontrino fiscale.

La garanzia comprende la fornitura di parti di ricambio o la sostituzione del prodotto se necessario. La garanzia non comprende la riparazione in loco o il rimborso delle spese sostenute per il mancato utilizzo del prodotto.

In caso di vizio accertato da Scolaro, si riserva il diritto - a propria discrezione - di sostituire il prodotto con uno uguale o equivalente per caratteristiche essenziali o di rimborsare al cliente solo l'importo pagato per il prodotto. Nessuna ulteriore spesa o danno potranno essere richiesti a Scolaro.

Scolaro non sarà responsabile per eventuali danni a cose o persone derivanti da un uso improprio del prodotto.

POLITICA DI SERVIZIO E RIPARAZIONI

Anche in caso di danneggiamenti e rotture, Scolaro ha sempre adottato un'attenta e puntuale politica di assistenza post vendita.

In qualunque caso di danneggiamento o necessità, consigliamo di contattare la nostra azienda per valutare la possibilità di riparare e recuperare il prodotto, nonché per ottenere assistenza per eseguire l'intervento.

La corrispondenza ad alti standard qualitativi e funzionali dei materiali impiegati costituisce la garanzia principale della robustezza e resistenza nel tempo dei prodotti Scolaro. Un comportamento rispettoso di norme di manutenzione ed uso, come specificato di seguito, assicura una durata ancora maggiore.

Le informazioni contenute in questo catalogo o in altri stampati pubblicitari della ditta Scolaro, quali caratteristiche tecniche dei prodotti o dei componenti, dimensioni, schemi di montaggio, colori, ecc., hanno valore meramente indicativo, in ragione delle specifiche tecniche e della evoluzione tecnologica dei prodotti aziendali. Al fine di migliorare la qualità del prodotto, la ditta si riserva il diritto di modificare lo stesso senza alcun preavviso e anche dopo l'accettazione dell'ordine. L'azienda si riserva di apportare modifiche parziali o totali ai prodotti senza preavviso declinando ogni responsabilità su eventuali dati inesatti. Eventuali lievi variazioni di tonalità dei colori e delle finiture rientrano nelle normali caratteristiche dei materiali impiegati. Tutte le differenze sopraindicate non sono tali da modificare significativamente i prodotti stessi e non costituiscono motivo di reso o sostituzione della merce o di contestazione.

USE AND MAINTENANCE

DIRECTIONS

- Before use, directions and assembling instructions, which are inside the package, have to be kept and read carefully.
- The base has to be ballasted. An insufficient weight will seriously compromise the stability of the parasol.
- Always remove crank when not in use and keep out of reach of children.
- To avoid damage or personal injury, parasol must be closed and in some extreme weather conditions it may be necessary to remove the product and store it in a protected place. Remember always that the parasol is not a fixed construction. The company Scolaro cannot be held responsible for damages to goods supplied, or injury resulting from improper use and failure to follow instruction and guidelines given on.

PRODUCT EMPLOY

Before starting to open the parasol, make sure that the fabric has not got caught in the internal ribs. To open or close the parasol, turn the handle (where available) in the direction indicated by the arrows and the words "Open" or "Close". Incorrect operation could tear the string or damage the mechanism. Never force the ropes or handles. If they get stuck, check why this has happened and eliminate the possible cause.

Wooden parts: apply a wax-based wood-stainer at least once a year before the winter season.

Close the parasol when the weather conditions are unsuitable, strong wind or heavy rain.

Scolaro parasols can be combined with special bases developed for the ground fixing. If it is decided to position a Scolaro parasol using ballast only, their suitability for use in conditions of moderate wind is certified. In the specific table the minimum ballast weights are indicated. The Customer is the sole party responsible for installing and managing the parasol.

STAINLESS STEEL

Attention:

1. DO NOT USE THE FOLLOWING PRODUCTS on any parts made of stainless steel: Chlorine bleach or detergents containing bleach (they can corrode stainless steel). Hydrochloric acid or products containing chlorides (they can corrode stainless steel).
2. Salt, limestone or acids (drinks and food) may discolour parts made of stainless steel if not cleaned promptly.
3. Products or parts made of stainless steel used near the seaside or for the interior decoration of swimming pools require more frequent cleaning in order to remove chlorites deposited on them and to prevent corrosion and chemical deterioration of the external surfaces.
4. Stains or rust noted on stainless steel surfaces must be cleaned promptly.
5. Stains left in place for long periods may become permanent.
6. Rust may cause chemical reactions or corrode stainless steel.

To remove stains or rust:

- Apply a specific non-abrasive detergent or polish for stainless steel.
- Rinse thoroughly with clean water.
- Lastly, dry thoroughly in order to prevent streaks from occurring, rubbing in the sense of the fibres.

VARNISHED METALS: IRON AND ALUMINIUM

For a long lasting of the parasol we recommend to store it in dry environments, during the winter and when not in use. It's also recommended to check once a season, especially after a long period of inactivity, the proper functioning of all components. Our warranty does not cover any type of scratches or abrasions to

finish caused from the contact with other furniture or any resulting corrosion. The employ in marine environments can lead to the accumulation of salt and chlorides on the powder coating. Failure to perform regular cleaning with fresh water can cause blisters, oxidation, discoloration and invalidates the warranty. To clean surfaces in varnished metals, use cold water and non abrasive or aggressive liquid detergents.

Apply with a soft cloth. In the case of very dirty and/or aged surfaces, after cleaning, it is advisable to treat them with liquid paraffin. In the event of stains caused by lime deposits on varnishes of coarse structure (eg. antique iron and indian brown) clean them with a cloth and a solution of white wine vinegar diluted in cold water.

WOOD: IROKO

Traditional wood employed for outdoor furniture and the marine industry. Iroko is a hardwood with a high oil content, suitable for external use. Extremely long-lasting. It is practically unalterable to repeated exposure to atmospheric factors. Even if treated, the surface takes a silver-grey coating which is the natural protection from inside the wood, considered an essential part of Iroko's charm. The natural tendency of wood to turn gray or lose the brightness of the paint can be prevented in the early stages of the product life. The parasol can be restored by a new treatment with proper products easy to find in specialized shops. It's necessary to apply a solution of water and colourless oil, to exposed surfaces with a cloth. The oil must be highly diluted. Superficial stains can be removed by intervening in time, before the wood can fully absorb them. Gently sand the surface in question and then polish with a rough cloth.

SYNTHETIC FABRICS: ACRYL AND POLYESTER

The fabric is waterproof and anti mould treated to reject water, spots and grant transpiration. Please follow our maintenance instruction to grant the long lasting of the fabric:

- Remove often dust deposits, spots and any type of dirt in order to avoid trails after cleaning.
- It's very important to close the parasol only when it is perfectly dry. During the winter and when the parasol is not employed, it has to be stored in dry environment. Avoid prolonged contact with oily substances and/or dyes that could be absorbed by the covering material in PVC and cause permanent stains, in addition to damaging the structure of the thread. Do not use solvents or solvent-based detergents (avoid acetone). Use water and non-abrasive, colourless liquid detergents with a neutral PH. Let the detergent act for a few minutes. Rinse well with water no warmer than 30°C.

COMPONENTS

The steel components, screws and accessories are anti rust treated. Anyway for a long lasting of the parasol, during the winter and when the it is not employed, the parasol has to be stored in dry environment. During every season it is necessary to check the functionality of all components, especially after a long period of non-employ. The company Scolaro is at your disposal for technical assistance.

WARRANTY

Scolaro parasols are designed to last for many years exposed to outdoor use. As with many items, attention in use and maintenance and following the instructions contained in these pages, allows an even longer average life of the product and the possibility of enjoying an even more efficient and aesthetically pleasing product.

Scolaro's products are guaranteed for 2 years. If you comply with the indications and advices, the warranty can be extended as follows:

THE WARRANTY COVERS ONLY MANUFACTURING DEFFECTS OF STRUCTURAL INTEGRITY. THE WARRANTY DOES NOT COVER DAMAGES CAUSED BY MECHANICAL ACTIONS, FORCE OF NATURE AND MALICIOUS ACTS.

5 years warranty on aluminum and stainless steel components. Including painting and screws.

- Structural faults not resulting from improper use or lack maintenance.
- Invasive corrosion not produced by scratches or abrasions from use not removable through normal cleaning and maintenance.

5 year warranty on colors and treatment of fabrics (strength).

- The replacement of the canopy during the warranty period is foreseen only if it loses its color before the end of the warranty period. Users must properly maintain fabrics for the warranty to be effective. Proper maintenance implies regular cleaning.
- The warranty does not cover damage from contact with foreign objects, wind-driven abrasions, misuse or abuse (tears, burns and holes). The intensive employ in an aggressive environment (seaside and pool use), requires a regular rinse of the fabric with fresh water in order to prevent and avoid the build-up of salt and chloride residues.

2 years warranty on all metal and steel elements in general

2 years warranty in general for finishes and other materials not specifically mentioned and written above, including concrete bases and ballasts.

1 year warranty on LED light kits and electrical components in general.

THE WARRANTY DOES NOT APPLY:

- If the product has not been assembled according to the instructions provided;
- in the event of improper use of the product or use that does not conform to normal intended use of the property;
- in case of non-compliance with the instructions for use and maintenance indicated in the information material supplied with the product;
- in case of storage in environmental conditions that are not suitable for the product;
- in case of modification or tampering with the product;
- if the product has been assembled or combined with components and products not provided by Scolaro.

To take advantage of the warranty the faulty item must be shown or pictures must be forwarded, together with the invoice or receipt.

The warranty includes the supply of spare parts or the replacement of the product if necessary.

The warranty does not include the repair on-site or the refund of costs incurred for non-use of the product. In case of defect confirmed by Scolaro, it reserves the right - at its own discretion - to replace the product with an equal or equivalent one for essential characteristics or to refund only the amount paid for the product to the customer.

No further expenses or damages can be requested from Scolaro. Scolaro will not be liable for any damage to properties or individuals deriving from an improper use of the product.

SERVICE AND REPAIRS POLICY

Even in the event of damage and breakage, Scolaro has always adopted a careful and punctual after-sales assistance policy.

In any case of damage or need, we recommend contacting our company to evaluate the possibility of repairing and recovering the product, as well as to get assistance in carrying out the intervention.

The connection between the high qualitative and functional standards of the materials used, constitutes the main guarantee of the sturdiness and the resistance of the company's products over time. Respecting the rules of maintenance and use, specified as follows, will ensure the success of these objects, which were devised with Scolaro quality, to last a long time.

The information contained in this brochures or other Scolaro's advertisements prints, such as product specifications or components, dimensions, assembling instruction, colours, etc., are purely indicative, because of the technical specifications and the technological evolution of the company's products. In order to improve the quality of the product, the company reserves the right to change the same without prior notice and even after acceptance of the order. The company reserves the right to make partial or complete changes to the products without prior notice and declines any responsibility for inaccurate data. Any colour differences and changes of finishing have to be considered normal characteristics of the materials used. These differences do not significantly change the products and aren't reason for return or replacement of the goods or dispute.





- Dimensione (metri)
- Dimensions (meters)
- Masse (Meter)
- Dimensions (mètres)
- Dimensiones (en metros)
- Afmeting in (meters)



- Lunghezza
- Length
- Laenge
- Longueur
- Longitud



- Peso
- Weight
- Gewicht
- Poids
- Peso
- Gewicht



- Volume (m³)
- Volume (m³)
- Volumen (m³)
- Volume (m³)
- Volumen (m³)



- Sezione sostegno (mm)
- Support section (mm)
- Mastprofil (mm)
- Section support (mm)
- Sección soporte (mm)
- Mast (mm)



- Colore dei componenti/stecche
- Component/Ribs colour
- Farbe der Bestandteile und Streben
- Couleur des composants et baleines
- Color de los componentes ò piezas/Varillas ò listones



- Stecche
- Ribs
- Streben
- Baleines
- Varillas
- Baleinen



- Set canaline
- Raingutter set
- Regerinnen
- Set gouttières
- Canalizador Lluvias
- Set regengoten



- Sezione stecche
- Rib section
- Strebenprofil
- Section baleines
- Sección varillas
- Profil baleinen



- Camino antiviento
- Wind cap
- Windfang
- Souffle
- Chimenea antiviento
- Windvang



- Fodero
- Cover bag
- Schutzhuelle
- Housse
- Forro
- Afdekhoes



- Sistema retrattile
- Retractable system
- Einziehbares System
- Système retractile
- Sistema retráctil
- Inklapbaar systeem



- Stecca con sistema “easy change”
- Ribs with “easy change” system
- Streben mit “easy change” System
- Baleines avec “easy change” système
- Varillas con sistema de “ cambio fácil”
- Baleinen met het “easy change” systeem



- Piastre cemento
- Cement slabs
- Kiesbetonplatten
- Dalles ciment
- Planchas de cemento
- Betontegel

INOX

- Viteria in inox
- Screws in Stainless steel
- Edelstahlschrauben
- Visserie inox
- Tornillos en acero inoxidable
- Schroeven van rvs



- Tipo finitura della struttura/sostegno/componenti
- Finishing for frame/structure/components
- Ausfuehrung des Gestells/der StrENtur/der Bestandteile
- Finition armature/structure/composants
- Tipo de acabadò de la estructura/Soportes/ componente



- Apertura con molla a gas
- Gas spring opening
- Oeffnung mit Gasdruckfeder
- Ouverture avec ressort à gaz
- Apertura con resorte de gas
- Licht te openen dankzij de gasveer



SCOLARO PARASOL SRL UNIPERSONALE

Via Liguria, 197 35040 – Casale di Scodosia (PD) - Italy
Tel +39 0429 656687

info@scolaro-parasol.it
scolaro-parasol.it



