

GERVASONI™

BRASS GRAY NEXT NUVOLA SPIN SWEET

# GERVASONI™

**BRASS  
GRAY  
NEXT  
NUVOLA  
SPIN  
SWEET**



GERVASONI™



GERVASONI™

**BRASS  
GRAY  
NEXT  
NUVOLA  
SPIN  
SWEET**

design PAOLA NAVONE



Sweet 91

Sweet 85

# stone house





Next 12

Filo 08

Gray 41

Next 144

Next 141

Gray 08

Gray 42

Gray 07



Gray 08

Gray 07

Next 141



Next 12

Gray 08

Next 144

Next 141



Brass 95

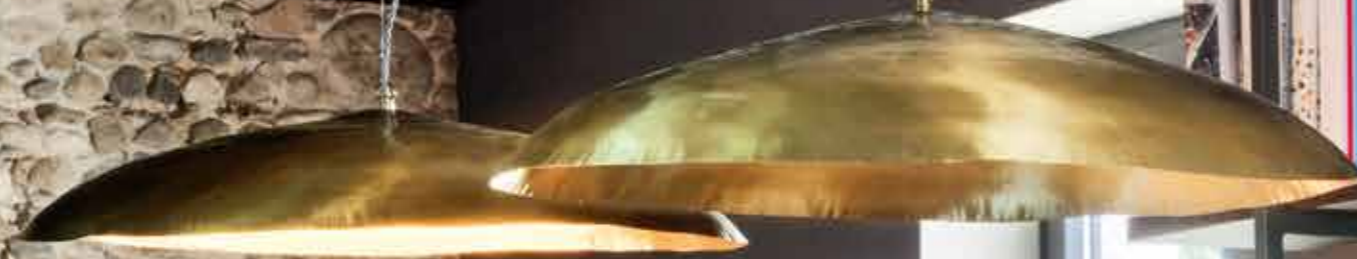

Brick 23

Gray 37

Gray 21

Gray 23



Gray 21

Gray 37







- 7
- 6
- 5
- 4
- 3
- 2

Next 20 L

Gray 54

Next 20 R

Brick 19

Inout 42



Gray 50

Allu 224 I

Inout 42





Gray 01

Ghost 08

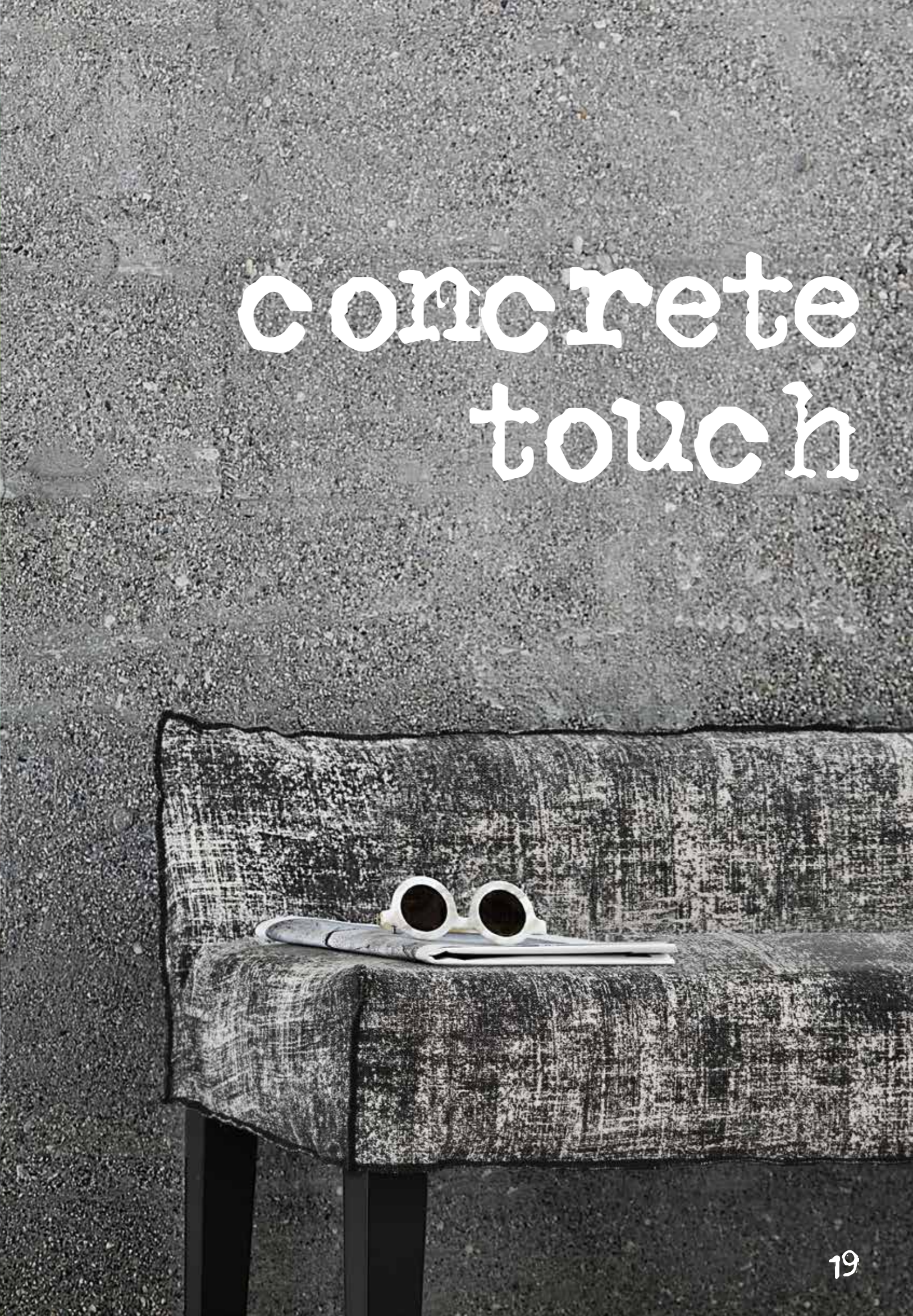

concrete  
touch



Up 15

Gray 39



Next 136

Next 23



Nuvola 12



Gray 56



Gray 01



Sweet 262

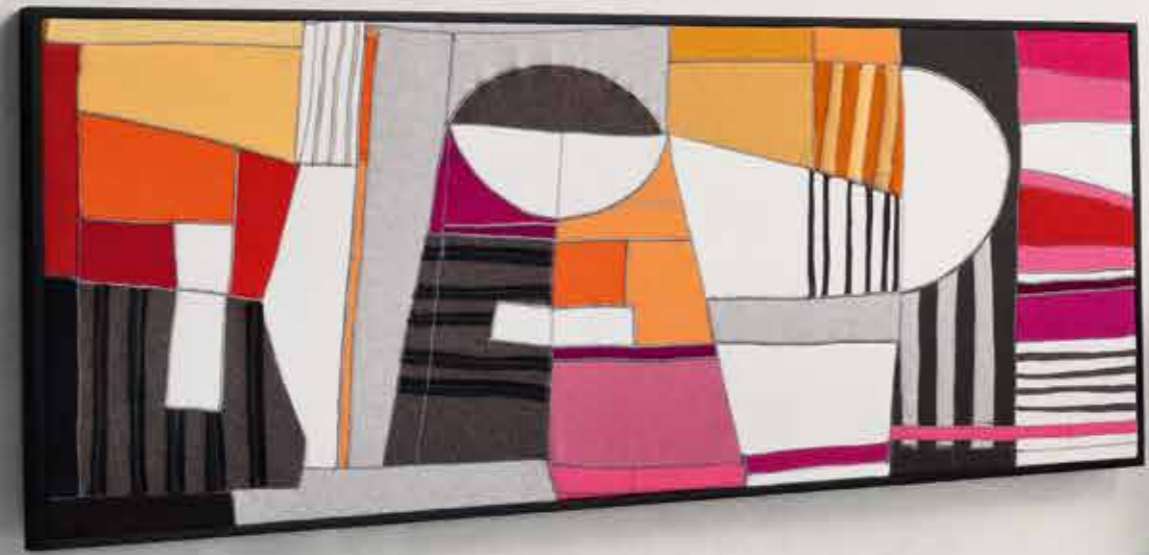

Nuvola 12



Sweet 262

Gray 56

Gray 56



Brass 96

Gray 32

Ghost 23





Gray 09

Sweet 61

Gray 44

Next 27



Sweet 61

Next 27

Gray 44

# powder blu living



Brass 45

Bolla 12

Gray 09





Irony 70

Irony 60

Bolla 12

Brass 45

Next 20 P L

Next 20 P R

Next 12 P

Bolla 13

Bolla 10

Gray 42

Bolla 15

Next 12 P

Gray 07



Next 20 P L

Next 20 P R

Irony 60

Bolla 13

Bolla 12

Brass 45



Gray 51

Spin 96

Spin 95

Sweet 97



Gray 07



Sweet 569



Brass 95



Gray 42



Gray 07



Gray 51



Allu 223 I



Brass 95

Gray 21

Gray 33

Allu 223 I

Next 24



Sweet 20

Gray 42

Brick 18

Sweet 41





Gray 44

Gray 61

Gray 80 E

# green view



Gray 49

Sweet 20



Gray 15

Sweet 20

Gray 46

Gray 49

Next 16 P



Sweet 91

Next 137

Gray 26

Gray 24





Sweet 367 L



Sweet 367 R



Nuvola 12



Sweet 41



Gray 46



Sweet 46



Sweet 27





Gray 47

Gray 33

Inout 23 IN

Inout 23 W





Gray 47



Inout 23 IN

Gray 33

Sweet 98



Sweet 265



Sweet 21 C



Gray 61





Spin 95

Next 27

Sweet 351

Ghost 80 E



Next 27

Sweet 41



Spin 95

Sweet 351

# living in an atelier



Next 20 P L

Gray 57



Nuvola 09

Sweet 364

Bolla 12

Gray 44



Bolla 12

Gray 44

Nuvola 09



Sweet 364



Brass 95

Gray 33

Ghost 23

Gray 21





Next 01

Gray 55

Gray 07

Gray 54

Gray 03



Gray 03





Sweet 95

Brick 23

Gray 32

Next 23

Gray 21



Next 05 P

Sweet 263



Spin 95

Gray 45

Gray 80 E

Sweet 263



Gray 45



Chic  
house



Next 132



Spin M / S

Spin L

Next 12

Next 142

Bolla 12

Next 144

Bolla 13

Sweet 46

Sweet 41

Next 16

Next 141





Next 16

Next 141





Spin M

Spin S

Spin L



Sweet 96

Next 23

Next 138

Sweet 21



Corallo



Sweet 384



Gray 50

Gray 26



Sweet 98



Sweet 27



Gray 44



Next 05



Gray 46 R



Next 10





Inout 23 IN

Gray 34

Sweet 21



Gray 23

Sweet 21

Gray 51

- Fabrics
- Materials
- Technical Data



PAG. 4-5

1 NEXT 12 / IUTA grigio - D  
 1 GRAY S / IUTA grigio - D  
 2 GRAY S / INTRECCIO nocciola - D  
 2 GRAY 08 / INTRECCIO nocciola - D

2 GRAY 07 / INTRECCIO nocciola - D  
 3 GRAY S / 3D grafite - E



PAG. 6-7

1 GRAY 08 / 3D grafite - E  
 2 GRAY 07 / INTRECCIO nocciola - D



PAG. 14-15

1 NEXT 20 L-R / JACK marrone - C  
 2 NEXT 20 L-R / INTRECCIO nocciola - D  
 3 BRICK 19 / KANTHA autunno - C



PAG. 18-19

1 GRAY 01 / GUNNAR ossidiana - C  
 2 GRAY 01 / IUTA asfalto - D  
 3 GRAY 01 / FURBY ardesia - B  
 4 GRAY 01 / FURBY inchiostro - B  
 5 GHOST 08 / KANTHA inverno - C

6 UP 15 / JEANS nero - D



PAG. 22-23

1 NEXT 23 / DENIM blu - C



PAG. 24-25

1 NUVOLA 12 / 3D grafite - E  
 2 GRAY 01 / GUNNAR ossidiana - C  
 3 GRAY 01 / IUTA asfalto - D  
 4 GRAY 01 / FURBY ardesia - B  
 5 GRAY 01 / FURBY inchiostro - B





PAG. 28-29

1 GHOST 23 / TRAMA aneto - C



PAG. 30-31

1 GRAY 09 / IUTA asfalto - D  
2 GRAY 09 / OUTDOOR 5 tithonia - C  
3 GRAY 09 / KANTHA estate - C

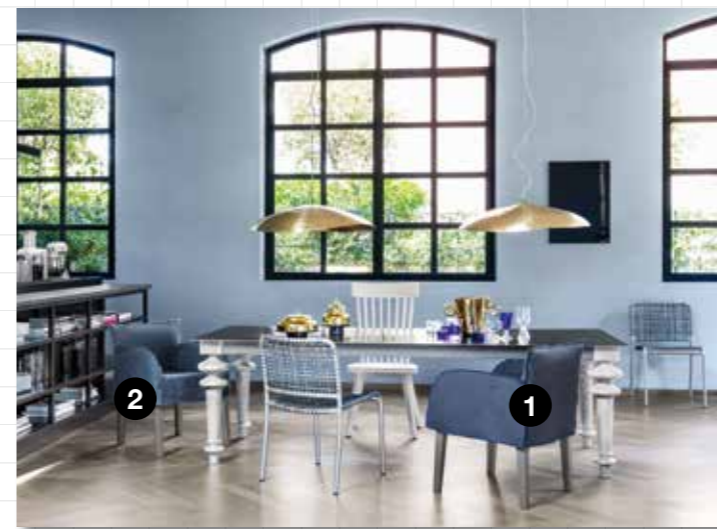

PAG. 42-43

1 NEXT 24 / KHANTA primavera  
2 NEXT 24 / MALTA laguna - C



PAG. 44-45

1 SWEET 20 / TRAMA anice - C  
2 BRICK 18 / IUTA grigio - D



PAG. 32-33

1 GRAY 09 / GUNNAR acquamarina - C  
2 GRAY 09 / OUTDOOR 5 rhombus - C



PAG. 34-35

1 GRAY 07 / DENIM azzurro - C  
2 GRAY 07 / KANTHA primavera - C  
3 GRAY 07 / MATRA china - C  
4 NEXT 12 P / ARTIST cezanne - C  
5 GRAY S / MATRA china - C  
5 NEXT 12 / KANTHA primavera - C



PAG. 46-47

1 GRAY 80 / IUTA petrolio - D



PAG. 50-51

1 GRAY 15 / JEANS grigio - D  
2 SWEET 20 / TRAMA cumino - C  
3 NEXT 16 P / ARTIST cezanne - C  
4 NEXT 16 P / STONE WASHED glacé - D  
5 NEXT 16 P / STONE WASHED panna - D



PAG. 36-37

1 NEXT 20 P L / KANTHA primavera - C  
2 NEXT 20 P L / ARTIST cezanne - C  
1 NEXT 20 P R / KANTHA primavera - C  
3 GRAY S / MATRA china - C  
4 GRAY S / POIS oceano - D



PAG. 40-41

1 GRAY 07 / DENIM azzurro - C  
2 GRAY 07 / KANTHA primavera - C  
3 GRAY 07 / MATRA china - C



PAG. 52-53

1 GRAY 26 / IUTA asfalto - D  
2 GRAY 26 / STRUCTURES calcare - C



PAG. 58-59

1 NUVOLA 12 / TRAMA cumino - C



PAG. 66-67  
1 GHOST 80 / NATURAL lino - B

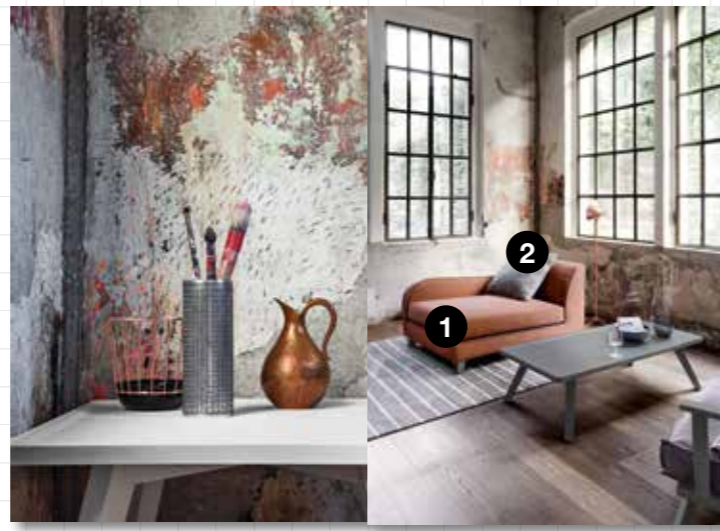

PAG. 70-71  
1 NEXT 20 P L / MINU' mattone - C  
2 NEXT 20 P L / JACK marrone - C



PAG. 84-85  
1 NEXT 05 P / JACK marrone - C



PAG. 86-87  
1 GRAY 80 / STRUCTURES calcare - C



PAG. 72-73  
1 NUVOVA 09 / 3D grigio - E



PAG. 76-77  
1 GRAY 21 / POIS cemento - D  
2 GHOST 23 / IUTA melanzana - D



PAG. 92-93  
1 NEXT 16 / TRAMA aneto - C  
2 NEXT 16 / IUTA petrolio - D  
3 NEXT 12 / JACK verde - C  
4 NEXT 12 / OUTDOOR 5 lithodora - C



PAG. 96-97  
1 NEXT 23 / IUTA petrolio - D



PAG. 78-79  
1 GRAY 07 / IUTA melanzana - D  
2 GRAY 07 / IUTA rosa - D  
3 GRAY 07 / ARTIST basquiat - C  
4 NEXT 01 / ARTIST monet - C  
5 NEXT 01 / POIS cemento - D  
6 GRAY 03 / ARTIST basquiat - C  
7 GRAY 03 / IUTA melanzana - D  
8 GRAY 03 / ARTIST goya - C  
9 GRAY 03 / MINU' fumo - C  
10 GRAY 03 / POIS cemento - D



PAG. 82-83  
1 NEXT 23 / IUTA melanzana - D



PAG. 100-101  
1 GRAY 26 / IUTA petrolio - D



PAG. 102-103  
1 NEXT 10 / MINU' pavone - C  
2 NEXT 05 / TRAMA aneto - C

**WOOD COLOURS**



Natural Oak    Natural American walnut    White    Grey    Black    Airforce blue

**TOP**

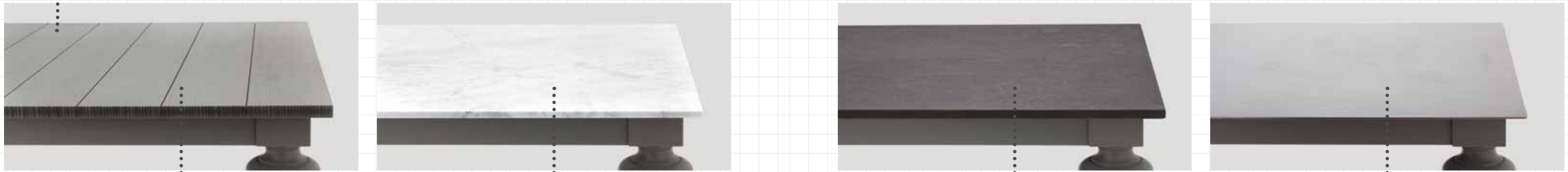

Wood    White Carrara marble    Rough cut slate    Waxed iron plate

**Gray table**

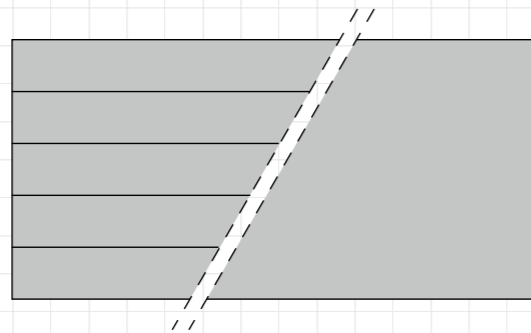
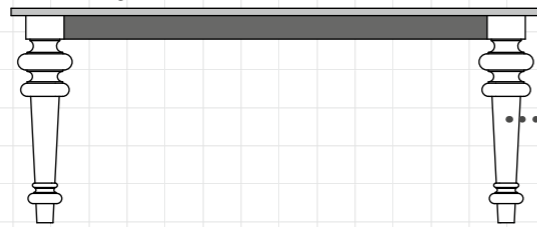

Wooden slats

White Carrara marble  
/ Rough cut slate  
/ Waxed iron plate

**LEGS**



Wood    Flamed piasentina stone    White Carrara marble    White china

**WOOD COLOURS**



Natural Oak    Natural American walnut    White    Grey    Black    Airforce blue

**WOOD COLOURS**



Natural American walnut    White    Grey    Black    Airforce blue

**WOOD COLOURS**



Natural American walnut    White    Grey    Black    Airforce blue

**BAMBOO COLOURS**

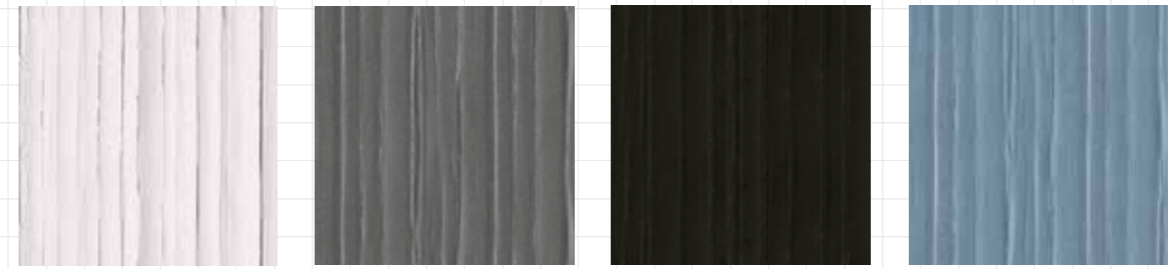

White    Grey    Black    Airforce blue

Next table

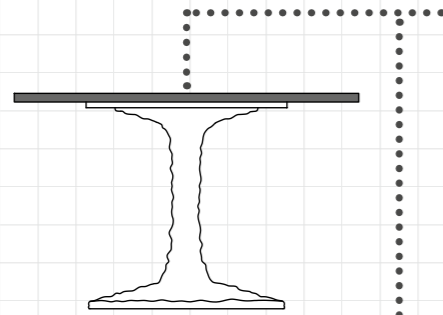

**TOP**



Wood



White Carrara marble



HPL

Sweet cabinet



**FEET**

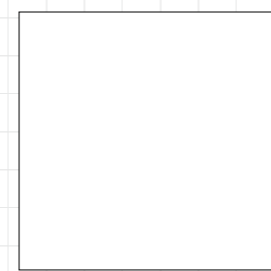

White lacquered metal

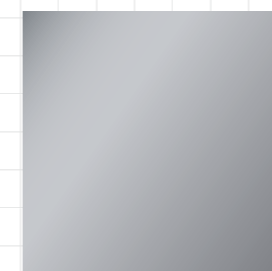

Brushed metal

**WOOD COLOURS**

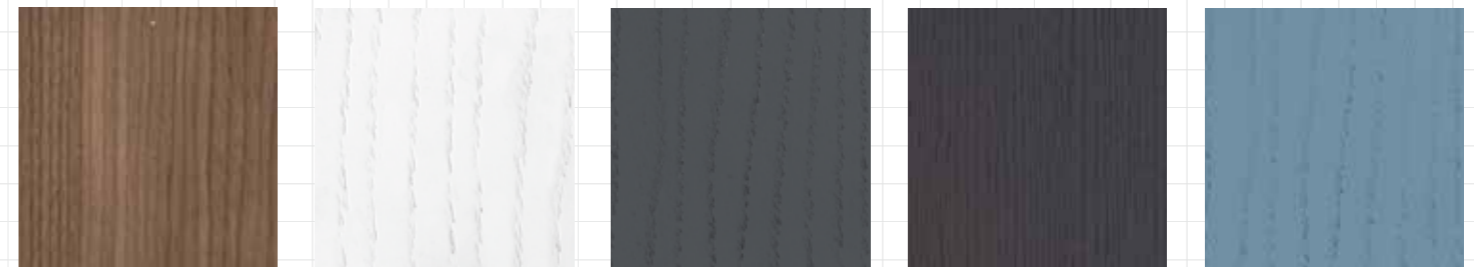

Natural American walnut    White    Grey    Black    Airforce blue

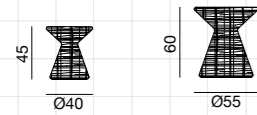

p. 32 / 34-35 / 37 / 73 / 74 / 92-93

Tavolino / pouf in midollino naturale mélange, laccato bianco, grigio, avio, nero.

Side table / ottoman in natural melange rattan core, white, grey, air force blue, black lacquered.

Beistelltisch / Pouf aus naturbelassenem Peddigrohr oder weiß, grau, schieferblau, schwarz lackiert.

Guéridon / pouf en moelle de rotin naturelle non teintée ou bien laqué: blanc, gris, bleu ardoise, noir.

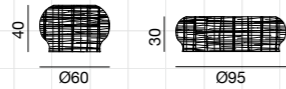

p. 34 / 35

Tavolino / pouf in midollino naturale mélange, laccato bianco, grigio, avio, nero.

Side table / ottoman in natural melange rattan core, white, grey, air force blue, black lacquered.

Beistelltisch / Pouf aus naturbelassenem Peddigrohr oder weiß, grau, schieferblau, schwarz lackiert.

Table basse/ pouf en moelle de rotin naturelle non teintée ou bien laqué: blanc, gris, bleu ardoise, noir.

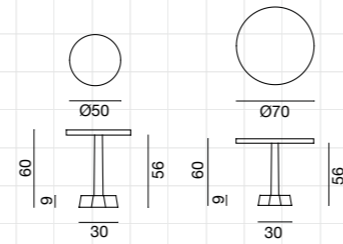

Tavolo, base in fusione di ghisa. Colonna in faggio tinto ebano. Piano in ottone lucido.

Table, central base in cast iron. Column in beech, ebony colour. Glossy brass top.

Tisch, Unterbau aus Gusseisen. Säule aus Buche, Farbe ebenholz. Platte aus glänzendem Messing.

Table, base en fonte. Colonne en hêtre teinté ébène. Dessus en laiton brillant.

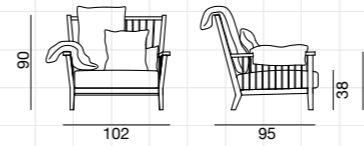

p. 18 / 25

Poltrona, struttura in noce o rovere. Finiture legno disponibili: noce Canaletto / rovere verniciati naturale; rovere laccato bianco, grigio, avio, nero. Cuscini volanti: due 110x45, due 45x45, uno 60x45 cm.

Lounge chair, frame in walnut or oak. Available wood finishes: natural lacquered American walnut / oak; white, grey, air force blue, black lacquered oak. Loose cushions: two 110x45, two 45x45, one 60x45 cm.

Sessel, Gestell aus Nussbaum oder Eiche. Lieferbare Holz Ausführungen: amerikanisches Nussbaum / Eiche natur lasiert; Eiche weiß, grau, schieferblau, schwarz lackiert. Wurfkissen: zwei 110x45, zwei 45x45, eins 60x45 cm.

Fauteuil, structure en noyer ou chêne. Finitions du bois disponibles: noyer américain / chêne vernis naturel; chêne laqué blanc, gris, bleu ardoise, noir. Coussins dossier: deux 110x45, deux 45x45, un 60x45 cm.

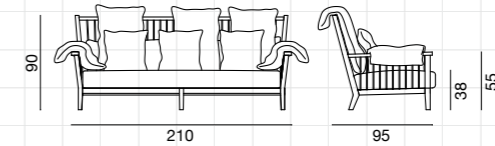

p. 79 / 80

Divano a tre posti, struttura in noce o rovere. Finiture legno disponibili: noce Canaletto / rovere verniciati naturale; rovere laccato bianco, grigio, avio, nero. Cuscini volanti: cinque 110x45, tre 45x45, due 60x45 cm.

Sofa, frame in walnut or oak. Available wood finishes: natural lacquered American walnut / oak; white, grey, air force blue, black lacquered oak. Loose cushions: five 110x45, three 45x45, two 60x45 cm.

Dreisitzer, Gestell aus Nussbaum oder Eiche. Lieferbare Holz Ausführungen: amerikanisches Nussbaum / Eiche natur lasiert; Eiche weiß, grau, schieferblau, schwarz lackiert. Wurfkissen: fünf 110x45, drei 45x45, zwei 60x45 cm.

Canapé trois places, structure en noyer ou chêne. Finitions du bois disponibles: noyer américain / chêne vernis naturel; chêne laqué blanc, gris, bleu ardoise, noir. Coussins dossier: cinq 110x45, trois 45x45, deux 60x45 cm.

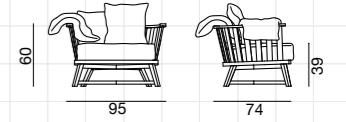

p. 4-5 / 7 / 34 / 38 / 78

Poltroncina bassa, struttura in noce o rovere. Finiture legno disponibili: noce Canaletto / rovere verniciati naturale; rovere laccato bianco, grigio, avio, nero. Cuscini volanti: uno 45x45, due 60x45 cm.

Armchair, frame in walnut or oak. Available wood finishes: natural lacquered American walnut / oak; white, grey, air force blue, black lacquered oak. Loose cushions: one 45x45, two 60x45 cm.

Sessel, Gestell aus Nussbaum oder Eiche. Lieferbare Holz Ausführungen: amerikanisches Nussbaum / Eiche natur lasiert; Eiche weiß, grau, schieferblau, schwarz lackiert. Wurfkissen: eins 45x45, zwei 60x45 cm.

Fauteuil, structure en noyer ou chêne. Finitions du bois disponibles: noyer américain / chêne vernis naturel; chêne laqué blanc, gris, bleu ardoise, noir. Coussins dossier: un 45x45, deux 60x45 cm.

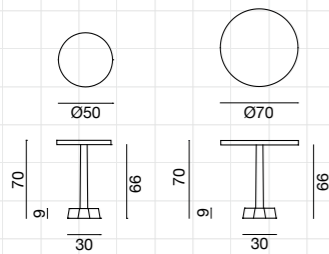

p. 32 / 35 / 37

Tavolo, base in fusione di ghisa. Colonna in faggio tinto ebano. Piano in ottone lucido.

Table, central base in cast iron. Column in beech, ebony colour. Glossy brass top.

Tisch, Unterbau aus Gusseisen. Säule aus Buche, Farbe ebenholz. Platte aus glänzendem Messing.

Table, base en fonte. Colonne en hêtre teinté ébène. Dessus en laiton brillant.

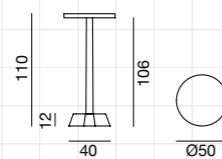

Tavolo, base in fusione di ghisa. Colonna in faggio tinto ebano. Piano in ottone lucido.

Table, central base in cast iron. Column in beech, ebony colour. Glossy brass top.

Tisch, Unterbau aus Gusseisen. Säule aus Buche, Farbe ebenholz. Platte aus glänzendem Messing.

Table, base en fonte. Colonne en hêtre teinté ébène. Dessus en laiton brillant.

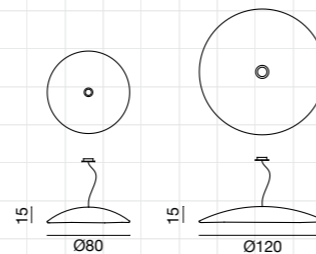

p. 10-11 / 29 / 40 / 42-43 / 76-77

Lampada a sospensione in ottone opaco martellato. Potenza max. applicabile 18 W, 220 Volt, attacco E 27, lampada non fornita.

Suspension lamp in hammered matt brass, max. power 18 W, 220 Volt, bulb holder E 27, bulb not included.

Deckenleuchte aus mattem Messing, gehämmert. Maximale Stärke 18 W, 220 Volt, Lampenfassung E 27, Birne nicht mitgeliefert.

Suspension en laiton martelé mat, puissance max. 18 W, 220 Volt, douille de lampe E 27, ampoule non fournie.

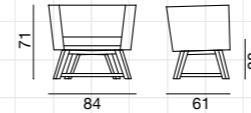

p. 4-5 / 6 / 8

Poltroncina bassa in noce o rovere, seduta e schienale imbottiti in poliuretano espanso. Rivestimento sfoderabile. Finiture legno disponibili: noce Canaletto / rovere verniciati naturale; rovere laccato bianco, grigio, avio, nero.

Armchair in walnut or oak, upholstered seat and back in polyurethane foam, removable cover. Available wood finishes: natural lacquered American walnut / oak; white, grey, air force blue, black lacquered oak.

Sessel aus Nussbaum oder Eiche, gepolsterte Sitz und Rückenlehne, abziehbar. Lieferbare Holz Ausführungen: amerikanisches Nussbaum / Eiche natur lasiert; Eiche weiß, grau, schieferblau, schwarz lackiert.

Fauteuil en noyer ou chêne, assise et dossier rembourrés en mousse polyuréthane, déhoussable. Finitions du bois disponibles: noyer américain / chêne vernis naturel; chêne laqué blanc, gris, bleu ardoise, noir.

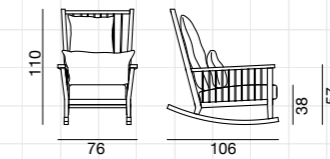

p. 30 / 32

Dondolo, struttura in noce o rovere. Finiture legno disponibili: noce Canaletto / rovere verniciati naturale; rovere laccato bianco, grigio, avio, nero. Cuscini volanti: uno 60x76, uno 60x45 cm.

Rocking-chair, frame in walnut or oak. Available wood finishes: natural lacquered American walnut / oak; white, grey, air force blue, black lacquered oak. Loose cushions: one 60x76, one 60x45 cm.

Schaukelstuhl, Gestell aus Nussbaum oder Eiche. Lieferbare Holz Ausführungen: amerikanisches Nussbaum / Eiche natur lasiert; Eiche weiß, grau, schieferblau, schwarz lackiert. Wurfkissen: eins 60x76, eins 60x45 cm.

Fauteuil à bascule, structure en noyer ou chêne. Finitions du bois disponibles: noyer américain / chêne vernis naturel; chêne laqué blanc, gris, bleu ardoise, noir. Coussins dossier: un 60x76, un 60x45 cm.

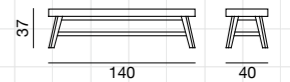

p. 48 / 50

Panca, struttura in noce, seduta imbottita in poliuretano espanso, rivestimento sfoderabile. Finiture legno disponibili: noce Canaletto verniciato naturale; laccato bianco, grigio, avio, nero.

Bench, frame in walnut. Seat upholstered with polyurethane foam, removable cover. Available wood finishes: natural, white, grey, air force blue, black lacquered American walnut.

Bank, Gestell aus Nussbaum. Sitz aus Polyurethanschaum, abziehbar. Lieferbare Holz Ausführungen: amerikanisches Nussbaum natur lasiert; weiß, grau, schieferblau, schwarz lackiert.

Banquette, structure en noyer. Assise en mousse polyuréthane, déhoussable. Finitions du bois disponibles: noyer américain verni naturel; laqué blanc, gris, bleu ardoise, noir.

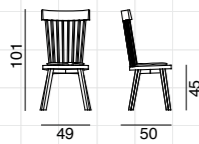

p. 10-11 / 12 / 42-43 / 76-77 / 82-83

Sedia con schienale alto, struttura in noce o rovere. Finiture legno disponibili: noce Canaletto / rovere verniciati naturale; rovere laccato bianco, grigio, avio, nero. Cuscino seduta opzionale in poliuretano espanso.

Chair with high back, frame in walnut or oak. Available wood finishes: natural lacquered American walnut / oak; white, grey, air force blue, black lacquered oak. Optional seat cushion with polyurethane foams.

Stuhl mit Hochlehne, Gestell aus Nussbaum oder Eiche. Lieferbare Holz Ausführungen: amerikanisches Nussbaum / Eiche natur lasiert; Eiche weiß, grau, schieferblau, schwarz lackiert. Auf Wunsch Sitzkissen aus Polyurethanschaum.

Chaise avec haut dossier, structure en noyer ou chêne. Finitions du bois disponibles: noyer américain / chêne vernis naturel; chêne laqué blanc, gris, bleu ardoise, noir. Galette optionnelle en mousse polyuréthane.



p. 10-11 / 106

Sedia, struttura in noce o rovere. Finiture legno disponibili: noce Canaletto / rovere verniciati naturale; rovere laccato bianco, grigio, avio, nero. Cuscino seduta opzionale in poliuretano espanso.

Chair, frame in walnut or oak. Available wood finishes: natural lacquered American walnut / oak; white, grey, air force blue, black lacquered oak. Optional seat cushion with polyurethane foams.

Stuhl, Gestell aus Nussbaum oder Eiche. Lieferbare Holz Ausführungen: amerikanisches Nussbaum / Eiche natur lasiert; Eiche weiß, grau, schieferblau, schwarz lackiert. Auf Wunsch Sitzkissen aus Polyurethanschaum.

Chaise, structure en noyer ou chêne. Finitions du bois disponibles: noyer américain / chêne vernis naturel; chêne laqué blanc, gris, bleu ardoise, noir. Galette optionnelle en mousse polyuréthane.

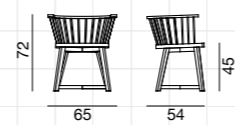

p. 52-53

Poltroncina, struttura in noce o rovere. Finiture legno disponibili: noce Canaletto / rovere verniciati naturale; rovere laccato bianco, grigio, avio, nero. Cuscino seduta e schienale opzionali in poliuretano espanso.

Chair, frame in walnut or oak. Available wood finishes: natural lacquered American walnut / oak; white, grey, air force blue, black lacquered oak. Optional seat / back cushions with polyurethane foams.

Stuhl, Gestell aus Nussbaum oder Eiche. Lieferbare Holz Ausführungen: amerikanisches Nussbaum / Eiche natur lasiert; Eiche weiß, grau, schieferblau, schwarz lackiert. Auf Wunsch Sitz- und Rücken kissen aus Polyurethanschaum.

Bridge, structure en noyer ou chêne. Finitions du bois disponibles: noyer américain / chêne vernis naturel; chêne laqué blanc, gris, bleu ardoise, noir. Galette optionnelles plus coussin dossier en mousse polyuréthane.

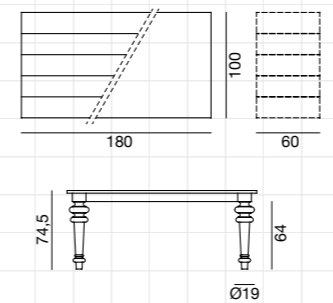

p. 104-105

Tavolo rettangolare con piano fisso a doghe di noce o rovere, ardesia a spacco, marmo bianco Carrara o lamiera di ferro cerata. Gambe in massello di noce / rovere, porcellana bianca, pietra Piasentina fiammata o marmo bianco Carrara. Finiture legno disponibili: noce Canaletto / rovere verniciato naturale; rovere laccato bianco, grigio, avio, nero. Disponibile anche con piano allungabile (+60 cm) a doghe di noce o rovere.

Rectangular table with fixed slat top in walnut / oak, rough-cut slate, white Carrara marble or waxed iron plate. Feet in solid walnut / oak, white china, white Carrara marble, flamed Piasentina stone. Available wood finishes: natural lacquered American walnut / oak; white, grey, air force blue, black lacquered oak. Available also with extendable slat top in walnut / oak (+60 cm).

Rechteckiger Tisch, feste Leistenplatte aus Nussbaum / Eiche, aus gespaltenem Schiefer, aus weißem Carrara-Marmor, aus gewachstem Stahl. Füße aus Nussbaum / Eiche massiv, aus weißer Porzellan, aus Naturstein (Pietra Piasentina geflammt), aus weißem Carrara-Marmor. Lieferbare Holz Ausführungen: amerikanisches Nussbaum / Eiche natur lasiert; Eiche weiß, grau, schieferblau, schwarz lackiert. Lieferbar auch mit ausziehbarer Leistenplatte (+ 60 cm) aus Nussbaum / Eiche.

Table rectangulaire, plateau fixe à lattes de noyer / chêne, en ardoise naturelle sans ponçage, en marbre blanc de Carrare, en tôle de fer cirée. Pieds en noyer / chêne massif, en porcelaine blanche, en pierre (Pietra Piasentina flammée), en marbre blanc de Carrare. Finitions du bois disponibles: noyer américain / chêne vernis naturel; chêne laqué blanc, gris, bleu ardoise, noir. Disponible avec plateau à lattes avec rallonge (+ 60 cm) en noyer / chêne.

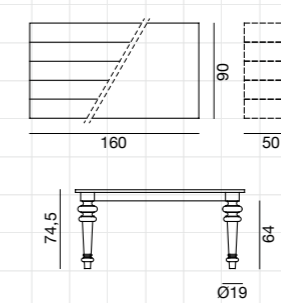

p. 4

Tavolo rettangolare con piano fisso a doghe di noce o rovere, ardesia a spacco, marmo bianco Carrara o lamiera di ferro cerata. Gambe in massello di noce / rovere, porcellana bianca, pietra Piasentina fiammata o marmo bianco Carrara. Finiture legno disponibili: noce Canaletto / rovere verniciato naturale; rovere laccato bianco, grigio, avio, nero. Disponibile anche con piano allungabile (+ 50 cm) a doghe di noce o rovere.

Rectangular table with fixed slat top in walnut / oak, rough-cut slate, white Carrara marble or waxed iron plate. Feet in solid walnut / oak, white china, white Carrara marble, flamed Piasentina stone. Available wood finishes: natural lacquered American walnut / oak; white, grey, air force blue, black lacquered oak. Available also with extendable slat top in walnut / oak (+ 50 cm).

Rechteckiger Tisch, feste Leistenplatte aus Nussbaum / Eiche, aus gespaltenem Schiefer, aus weißem Carrara-Marmor, aus gewachstem Stahl. Füße aus Nussbaum / Eiche massiv, aus weißer Porzellan, aus Naturstein (Pietra Piasentina geflammt), aus weißem Carrara-Marmor. Lieferbare Holz Ausführungen: amerikanisches Nussbaum / Eiche natur lasiert; Eiche weiß, grau, schieferblau, schwarz lackiert. Lieferbar auch mit ausziehbarer Leistenplatte (+ 50 cm) aus Nussbaum / Eiche.

Table rectangulaire, plateau fixe à lattes de noyer / chêne, en ardoise naturelle sans ponçage, en marbre blanc de Carrare, en tôle de fer cirée. Pieds en noyer / chêne massif, en porcelaine blanche, en pierre (Pietra Piasentina flammée), en marbre blanc de Carrare. Finitions du bois disponibles: noyer américain / chêne vernis naturel; chêne laqué blanc, gris, bleu ardoise, noir. Disponible avec plateau à lattes avec rallonge (+ 50 cm) en noyer / chêne.

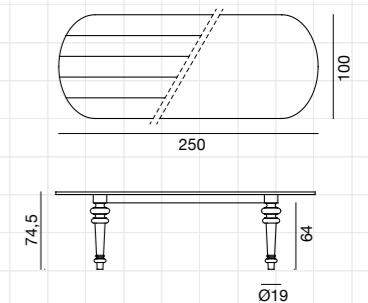

p. 10 / 11

Tavolo ovale con piano fisso a doghe di noce o rovere, ardesia a spacco o marmo bianco Carrara. Gambe in massello di noce / rovere, porcellana bianca, pietra Piasentina fiammata o marmo bianco Carrara. Finiture legno disponibili: noce Canaletto / rovere verniciato naturale; rovere laccato bianco, grigio, avio, nero.

Oval table with fixed slat top in walnut / oak, rough-cut slate or white Carrara marble. Feet in solid walnut / oak, white china, white Carrara marble, flamed Piasentina stone. Available wood finishes: natural lacquered American walnut / oak; white, grey, air force blue, black lacquered oak.

Ovaler Tisch, feste Leistenplatte aus Nussbaum / Eiche, aus gespaltenem Schiefer oder aus weißem Carrara-Marmor. Füße aus Nussbaum / Eiche massiv, aus weißer Porzellan, aus Naturstein (Pietra Piasentina geflammt), aus weißem Carrara-Marmor. Lieferbare Holz Ausführungen: amerikanisches Nussbaum / Eiche natur lasiert; Eiche weiß, grau, schieferblau, schwarz lackiert.

Table ovale, plateau fixe à lattes de noyer / chêne, en ardoise naturelle sans ponçage ou en marbre blanc de Carrare. Pieds en noyer / chêne massif, en porcelaine blanche, en pierre (Pietra Piasentina flammée), en marbre blanc de Carrare. Finitions du bois disponibles: noyer américain / chêne vernis naturel; chêne laqué blanc, gris, bleu ardoise, noir.

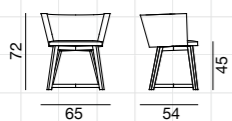

p. 52-53 / 100

Poltroncina, struttura in noce o rovere, seduta e schienale imbottiti in poliuretano espanso. Disponibile con rivestimento sfoderabile (Gray 26) o non sfoderabile (Gray 27). Finiture legno disponibili: noce Canaletto / rovere verniciati naturale; rovere laccato bianco, grigio, avio, nero.

Armchair in walnut or oak, upholstered seat and back in polyurethane foam, with removable (Gray 26) or not removable cover (Gray 27). Available wood finishes: natural lacquered American walnut / oak; white, grey, air force blue, black lacquered oak.

Stuhl aus Nussbaum oder Eiche, gepolsterte Sitz und Rückenlehne, abziehbar (Gray 26) oder nicht abziehbar (Gray 27). Lieferbare Holz Ausführungen: amerikanisches Nussbaum / Eiche natur lasiert; Eiche weiß, grau, schieferblau, schwarz lackiert.

Bridge en noyer ou chêne, assise et dossier rembourrés en mousse polyuréthane, déhoussable (Gray 26) ou non déhoussable (Gray 27). Finitions du bois disponibles: noyer américain / chêne vernis naturel; chêne laqué blanc, gris, bleu ardoise, noir.

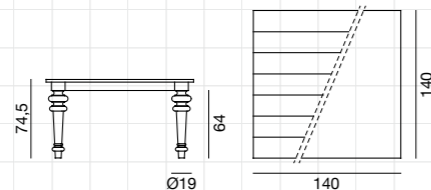

p. 29 / 82-83

Tavolo quadrato con piano fisso a doghe di noce o rovere, ardesia a spacco, marmo bianco Carrara o lamiera di ferro cerata. Gambe in massello di noce / rovere, porcellana bianca, pietra Piasentina fiammata o marmo bianco Carrara. Finiture legno disponibili: noce Canaletto / rovere verniciato naturale; rovere laccato bianco, grigio, avio, nero.

Square table with fixed slat top in walnut / oak, rough-cut slate, white Carrara marble or waxed iron plate. Feet in solid walnut / oak, white china, white Carrara marble, flamed Piasentina stone. Available wood finishes: natural lacquered American walnut / oak; white, grey, air force blue, black lacquered oak.

Viereckiger Tisch, feste Leistenplatte aus Nussbaum / Eiche, aus gespaltenem Schiefer, aus weißem Carrara-Marmor, aus gewachstem Stahl. Füße aus Nussbaum / Eiche massiv, aus weißer Porzellan, aus Naturstein (Pietra Piasentina geflammt), aus weißem Carrara-Marmor. Lieferbare Holz Ausführungen: amerikanisches Nussbaum / Eiche natur lasiert; Eiche weiß, grau, schieferblau, schwarz lackiert.

Table carrée, plateau fixe à lattes de noyer / chêne, en ardoise naturelle sans ponçage, en marbre blanc de Carrare, en tôle de fer cirée. Pieds en noyer / chêne massif, en porcelaine blanche, en pierre (Pietra Piasentina flammée), en marbre blanc de Carrare. Finitions du bois disponibles: noyer américain / chêne vernis naturel; chêne laqué blanc, gris, bleu ardoise, noir.

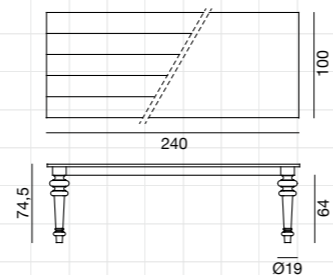

p. 42-43 / 60-61 / 76-77

Tavolo rettangolare con piano fisso a doghe di noce o rovere, ardesia a spacco, marmo bianco Carrara o lamiera di ferro cerata. Gambe in massello di noce / rovere, porcellana bianca, pietra Piasentina fiammata o marmo bianco Carrara. Finiture legno disponibili: noce Canaletto / rovere verniciato naturale; rovere laccato bianco, grigio, avio, nero.

Rectangular table with fixed slat top in walnut / oak, rough-cut slate, white Carrara marble or waxed iron plate. Feet in solid walnut / oak, white china, white Carrara marble, flamed Piasentina stone. Available wood finishes: natural lacquered American walnut / oak; white, grey, air force blue, black lacquered oak.

Rechteckiger Tisch, feste Leistenplatte aus Nussbaum / Eiche, aus gespaltenem Schiefer, aus weißem Carrara-Marmor, aus gewachstem Stahl. Füße aus Nussbaum / Eiche massiv, aus weißer Porzellan, aus Naturstein (Pietra Piasentina geflammt), aus weißem Carrara-Marmor. Lieferbare Holz Ausführungen: amerikanisches Nussbaum / Eiche natur lasiert; Eiche weiß, grau, schieferblau, schwarz lackiert.

Table rectangulaire, plateau fixe à lattes de noyer / chêne, en ardoise naturelle sans ponçage, en marbre blanc de Carrare, en tôle de fer cirée. Pieds en noyer / chêne massif, en porcelaine blanche, en pierre (Pietra Piasentina flammée), en marbre blanc de Carrare. Finitions du bois disponibles: noyer américain / chêne vernis naturel; chêne laqué blanc, gris, bleu ardoise, noir.

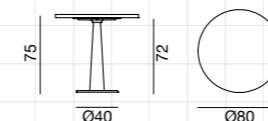

p. 21

Tavolo, base portante in ghisa verniciata colore nero e colonna centrale in massello di noce Canaletto, piano in noce canaletto impiallacciato. Finiture legno disponibili: noce Canaletto verniciato naturale; laccato bianco, grigio, avio, nero.

Table, central base in black cast iron, column in solid American walnut, top in natural lacquered American walnut veneer. Available wood finishes: natural, white, grey, air force blue, black lacquered American walnut.

Tisch, Unterbau aus schwarz lackiertem Gusseisen, Fuss aus amerikanischem Nussbaum massiv, Platte aus amerikanischem Nussbaum furniert. Lieferbare Holz Ausführungen: amerikanisches Nussbaum natur lasiert; weiß, grau, schieferblau, schwarz lackiert.

Table, base en fonte laquée noir, piétement en noyer américain massif, plateau en placage de noyer américain. Finitions du bois disponibles: noyer américain verni naturel; laqué blanc, gris, bleu ardoise, noir.

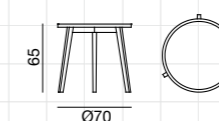

p. 4

Tavolino alto, struttura e piano in massello di noce o rovere. Finiture legno disponibili: noce Canaletto / rovere verniciati naturale; rovere laccato bianco, grigio, avio, nero.

Tea table, frame and top in solid walnut or oak. Available wood finishes: natural lacquered American walnut / oak; white, grey, air force blue, black lacquered oak.

Teetisch, Gestell und Platte aus Nussbaum oder Eiche massiv. Lieferbare Holz Ausführungen: amerikanisches Nussbaum / Eiche natur lasiert; Eiche weiß, grau, schieferblau, schwarz lackiert.

Table de thé, structure et dessus en noyer ou chêne massif. Finitions du bois disponibles: noyer américain / chêne vernis naturel; chêne laqué blanc, gris, bleu ardoise, noir.

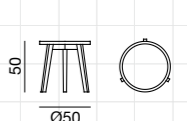

p. 35 / 40 / 44

Tavolino, struttura e piano in massello di noce o rovere. Finiture legno disponibili: noce Canaletto / rovere verniciati naturale; rovere laccato bianco, grigio, avio, nero.

Side table, frame and top in solid walnut / oak. Available wood finishes: natural lacquered American walnut; natural, white, grey, air force blue, black lacquered oak.

Beistelltisch, Gestell und Platte aus Nussbaum / Eiche massiv. Lieferbare Holz Ausführungen: amerikanisches Nussbaum / Eiche natur lasiert; Eiche weiß, grau, schieferblau, schwarz lackiert.

Guéridon, structure et dessus en noyer / chêne massif. Finitions du bois disponibles: noyer américain / chêne vernis naturel; chêne laqué blanc, gris, bleu ardoise, noir.

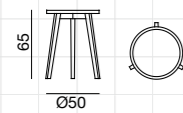

p. 30-31 / 46 / 73 / 74 / 102

Tavolino alto, struttura e piano in massello di noce o rovere. Finiture legno disponibili: noce Canaletto / rovere verniciati naturale; rovere laccato bianco, grigio, avio, nero.

Tea table, frame and top in solid walnut or oak. Available wood finishes: natural lacquered American walnut / oak; white, grey, air force blue, black lacquered oak.

Teetisch, Gestell und Platte aus Nussbaum oder Eiche massiv. Lieferbare Holzausführungen: amerikanisches Nussbaum / Eiche natur lasiert; Eiche weiß, grau, schieferblau, schwarz lackiert.

Table de thé, structure et dessus en noyer ou chêne massif. Finitions du bois disponibles: noyer américain / chêne vernis naturel; chêne laqué blanc, gris, bleu ardoise, noir.

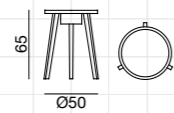

p. 87 / 89

Tavolino alto con cassetto sottopiano, struttura e piano in massello di noce o rovere. Finiture legno disponibili: noce Canaletto / rovere verniciati naturale; rovere laccato bianco, grigio, avio, nero.

Side table with drawer, frame and top in solid walnut / oak. Available wood finishes: natural lacquered American walnut; natural, white, grey, air force blue, black lacquered oak.

Beistelltisch mit Schublade, Gestell und Platte aus Nussbaum / Eiche massiv. Lieferbare Holzausführungen: amerikanisches Nussbaum / Eiche natur lasiert; Eiche weiß, grau, schieferblau, schwarz lackiert.

Guéridon avec tiroir, structure et dessus en noyer / chêne massif. Finitions du bois disponibles: noyer américain / chêne vernis naturel; chêne laqué blanc, gris, bleu ardoise, noir.

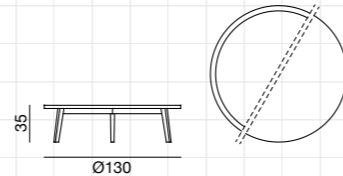

p. 50 / 58

Tavolino basso, struttura e piano in massello di noce o rovere (Gray 46) o con piano in noce o rovere impiallacciato (Gray 46 R). Finiture legno disponibili: noce Canaletto / rovere verniciati naturale; rovere laccato bianco, grigio, avio, nero.

Coffee table, frame and top in solid walnut / oak (Gray 46) or with walnut or oak veneer top (Gray 46 R). Available wood finishes: natural lacquered American walnut; natural, white, grey, air force blue, black lacquered oak.

Couchtisch, Gestell und Platte aus Nussbaum / Eiche massiv (Gray 46) oder mit Platte aus Nussbaum oder Eiche furniert (Gray 46 R). Lieferbare Holzausführungen: amerikanisches Nussbaum / Eiche natur lasiert; Eiche weiß, grau, schieferblau, schwarz lackiert.

Table basse, structure et dessus en noyer / chêne massif (Gray 46) ou avec dessus en noyer ou chêne plaqué (Gray 46 R). Finitions du bois disponibles: noyer américain / chêne vernis naturel; chêne laqué blanc, gris, bleu ardoise, noir.

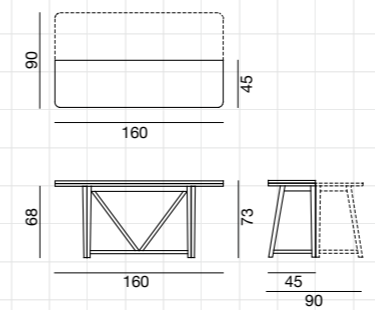

p. 38 / 41 / 106-107

Tavolo-consolle con apertura a ribalta, struttura e piano noce o rovere. Finiture legno disponibili: noce Canaletto verniciato naturale o rovere laccato bianco, grigio, avio o nero.

Flip top console table, frame and top in walnut or oak. Available wood finishes: natural lacquered American walnut; white, grey, air force blue or black lacquered oak.

Konsoltisch, aufklappbare Platte, Gestell und Platte aus Nussbaum oder Eiche. Lieferbare Farbausführungen: Nussbaum natur lasiert, Eiche weiß, grau, schieferblau oder schwarz lackiert.

Console avec plateau pliant, structure et dessus en noyer ou en chêne. Finitions du bois disponibles: noyer américain vernis naturel; chêne laqué blanc, gris, bleu ardoise, noir.

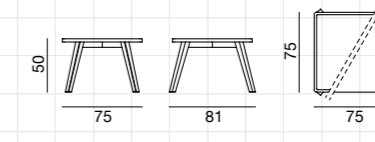

p. 14-15 / 79

Tavolino quadrato, struttura e piano in massello di noce o rovere (Gray 54) o con piano in noce o rovere impiallacciato (Gray 54 R). Finiture legno disponibili: noce Canaletto / rovere verniciato naturale; rovere laccato bianco, grigio, avio, nero.

Square side table, frame and top in solid walnut or oak (Gray 54) or with walnut or oak veneer top (Gray 54 R). Available wood finishes: natural lacquered American walnut / oak; white, grey, air force blue, black lacquered oak.

Viereckiger Beistelltisch, Gestell und Platte aus Nussbaum oder Eiche massiv (Gray 54) oder mit Platte aus Nussbaum oder Eiche furniert (Gray 54 R). Lieferbare Holzausführungen: amerikanisches Nussbaum / Eiche natur lasiert; Eiche weiß, grau, schieferblau, schwarz lackiert.

Guéridon carré, structure et dessus en noyer ou chêne massif (Gray 54) ou avec dessus en noyer ou chêne plaqué (Gray 54 R). Finitions du bois disponibles: noyer américain / chêne vernis naturel; chêne laqué blanc, gris, bleu ardoise, noir.

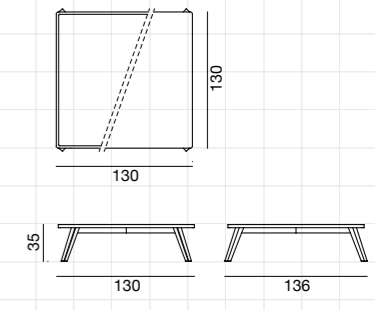

p. 78

Tavolino basso quadrato, struttura e piano in massello di noce o rovere (Gray 55) o con piano in noce o rovere impiallacciato (Gray 55 R). Finiture legno disponibili: noce Canaletto / rovere verniciato naturale; rovere laccato bianco, grigio, avio, nero.

Square coffee table, frame and top in solid walnut or oak (Gray 55) or with walnut or oak veneer top (Gray 55 R). Available wood finishes: natural lacquered American walnut / oak; white, grey, air force blue, black lacquered oak.

Viereckiger Couchtisch, Gestell und Platte aus Nussbaum oder Eiche massiv (Gray 55) oder mit Platte aus Nussbaum oder Eiche furniert (Gray 55 R). Lieferbare Holzausführungen: amerikanisches Nussbaum / Eiche natur lasiert; Eiche weiß, grau, schieferblau, schwarz lackiert.

Table basse carrée, structure et dessus en noyer ou chêne massif (Gray 55) ou avec dessus en noyer ou chêne plaqué (Gray 55 R). Finitions du bois disponibles: noyer américain / chêne vernis naturel; chêne laqué blanc, gris, bleu ardoise, noir.

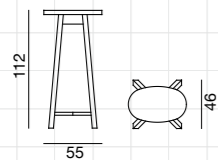

p. 61 / 62

Colonnina, struttura in noce. Piano superiore in porcellana bianca. Finiture legno disponibili: noce Canaletto verniciato naturale, laccato bianco, grigio, avio, nero.

Flower stand, frame in walnut. Top in white china. Available wood finishes: natural, white, grey, air force blue, black lacquered American walnut.

Blumenständer, Gestell aus Nussbaum. Ablage aus weißer Porzellan. Lieferbare Holzausführungen: amerikanisches Nussbaum natur, weiß, grau, schieferblau, schwarz lackiert.

Jardinière, structure en noyer. Dessus en porcelain blanche. Finitions du bois disponibles: noyer américain vernis naturel, laqué blanc, gris, bleu ardoise, noir.

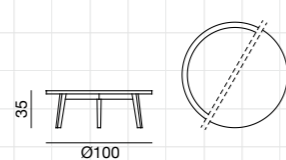

p. 49 / 50

Tavolino basso, struttura e piano in massello di noce o rovere (Gray 49) o con piano in noce o rovere impiallacciato (Gray 49 R). Finiture legno disponibili: noce Canaletto / rovere verniciati naturale; rovere laccato bianco, grigio, avio, nero.

Coffee table, frame and top in solid walnut / oak (Gray 49) or with walnut or oak veneer top (Gray 49 R). Available wood finishes: natural lacquered American walnut; natural, white, grey, air force blue, black lacquered oak.

Couchtisch, Gestell und Platte aus Nussbaum / Eiche massiv (Gray 49) oder mit Platte aus Nussbaum oder Eiche furniert (Gray 49 R). Lieferbare Holzausführungen: amerikanisches Nussbaum / Eiche natur lasiert; Eiche weiß, grau, schieferblau, schwarz lackiert.

Table basse, structure et dessus en noyer / chêne massif (Gray 49) ou avec dessus en noyer ou chêne plaqué (Gray 49 R). Finitions du bois disponibles: noyer américain / chêne vernis naturel; chêne laqué blanc, gris, bleu ardoise, noir.

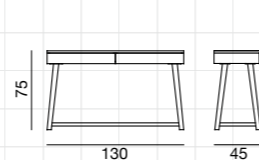

p. 16 / 100

Scrivitoio con due cassetti, struttura e piano in noce. Finiture legno disponibili: noce Canaletto verniciato naturale, laccato bianco, grigio, avio, nero.

Writing desk with two drawers, frame and top in walnut. Available wood finishes: natural, white, grey, air force blue, black lacquered American walnut.

Schreibtisch mit zwei Schubladen, Gestell und Platte aus Nussbaum. Lieferbare Holzausführungen: amerikanisches Nussbaum natur lasiert, weiß, grau, schieferblau, schwarz lackiert.

Bureau avec deux tiroirs, structure et dessus en noyer. Finitions du bois disponibles: noyer américain vernis naturel, laqué blanc, gris, bleu ardoise, noir.

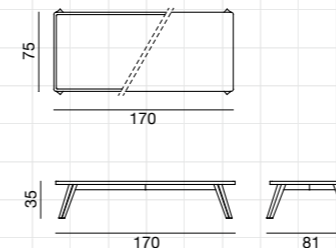

p. 24-25 / 26-27

Tavolino basso rettangolare, struttura e piano in massello di noce o rovere (Gray 56) o con piano in noce o rovere impiallacciato (Gray 56 R). Finiture legno disponibili: noce Canaletto / rovere verniciato naturale; rovere laccato bianco, grigio, avio, nero.

Rectangular coffee table, frame and top in solid walnut or oak (Gray 56) or with walnut or oak veneer top (Gray 56 R). Available wood finishes: natural lacquered American walnut / oak; white, grey, air force blue, black lacquered oak.

Rechteckiger Couchtisch, Gestell und Platte aus Nussbaum oder Eiche massiv (Gray 56) oder mit Platte aus Nussbaum oder Eiche furniert (Gray 56 R). Lieferbare Holzausführungen: amerikanisches Nussbaum / Eiche natur lasiert; Eiche weiß, grau, schieferblau, schwarz lackiert.

Table basse rectangulaire, structure et dessus en noyer ou chêne massif (Gray 56) ou avec dessus en noyer ou chêne plaqué (Gray 56 R). Finitions du bois disponibles: noyer américain / chêne vernis naturel; chêne laqué blanc, gris, bleu ardoise, noir.

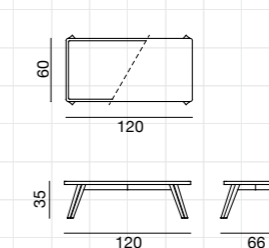

p. 71

Tavolino basso rettangolare, struttura e piano in massello di noce o rovere (Gray 57) o con piano in noce o rovere impiallacciato (Gray 57 R). Finiture legno disponibili: noce Canaletto / rovere verniciato naturale; rovere laccato bianco, grigio, avio, nero.

Rectangular coffee table, frame and top in solid walnut or oak (Gray 57) or with walnut or oak veneer top (Gray 57 R). Available wood finishes: natural lacquered American walnut / oak; white, grey, air force blue, black lacquered oak.

Rechteckiger Couchtisch, Gestell und Platte aus Nussbaum oder Eiche massiv (Gray 57) oder mit Platte aus Nussbaum oder Eiche furniert (Gray 57 R). Lieferbare Holzausführungen: amerikanisches Nussbaum / Eiche natur lasiert; Eiche weiß, grau, schieferblau, schwarz lackiert.

Table basse rectangulaire, structure et dessus en noyer ou chêne massif (Gray 57) ou avec dessus en noyer ou chêne plaqué (Gray 57 R). Finitions du bois disponibles: noyer américain / chêne vernis naturel; chêne laqué blanc, gris, bleu ardoise, noir.

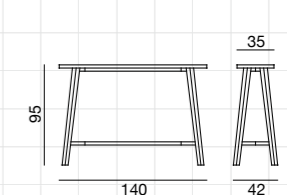

p. 47 / 65

Consolle, struttura e piano in massello di noce. Finiture legno disponibili: noce Canaletto verniciato naturale, laccato bianco, grigio, avio, nero.

Console table, frame and top in solid walnut. Available wood finishes: natural, white, grey, air force blue, black lacquered American walnut.

Konsoltisch, Gestell und Platte aus Nussbaum massiv. Lieferbare Holzausführungen: amerikanisches Nussbaum natur lasiert, weiß, grau, schieferblau, schwarz lackiert.

Console, structure et dessus en noyer massif. Finitions du bois disponibles: noyer américain vernis naturel, laqué blanc, gris, bleu ardoise, noir.

GRAY 80 E

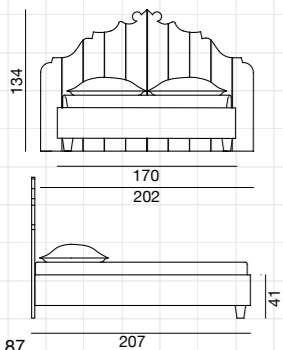

p. 46-47 / 87

Letto, testiera in noce canaletto verniciato naturale o rovere laccato bianco, grigio, avio, nero. Giroletto in multistrati di legno imbottito con poliuretano espanso, con supporti rete regolabili. Rivestimento sfoderabile. Rete in opzione (160 x 200 cm).

Bed, headboard in natural lacquered American walnut or in white, grey, air force blue, black lacquered oak. Upholstered plywood bed frame, removable cover, adjustable slat supports. Slat on request (160 x 200 cm).

Bett, Kopfteil aus amerikanisches Nussbaum natur lasiert oder aus Eiche, weiß, grau, schieferblau, schwarz lackiert. Bettgestell aus Multischichtholz, gepolstert, abziehbar, verstellbare Lattenrostträger. Lattenrost auf Wunsch (160 x 200 cm).

Lit, tête de lit en noyer américain verni naturel ou bien en chêne laqué blanc, gris, bleu ardoise, noir. Structure en multipli rembourré, déhoussable, supports sommier réglables. Sommier optionnel (160 x 200 cm).

GRAY 80 F

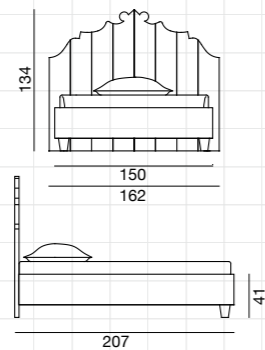

Letto, testiera in noce canaletto verniciato naturale o rovere laccato bianco, grigio, avio, nero. Giroletto in multistrati di legno imbottito con poliuretano espanso, con supporti rete regolabili. Rivestimento sfoderabile. Rete in opzione (140 x 200 cm).

Bed, headboard in natural lacquered American walnut or in white, grey, air force blue, black lacquered oak. Upholstered plywood bed frame, removable cover, adjustable slat supports. Slat on request (140 x 200 cm).

Bett, Kopfteil aus amerikanisches Nussbaum natur lasiert oder aus Eiche, weiß, grau, schieferblau, schwarz lackiert. Bettgestell aus Multischichtholz, gepolstert, abziehbar, verstellbare Lattenrostträger. Lattenrost auf Wunsch (140 x 200 cm).

Lit, tête de lit en noyer américain verni naturel ou bien en chêne laqué blanc, gris, bleu ardoise, noir. Structure en multipli rembourré, déhoussable, supports sommier réglables. Sommier optionnel (140 x 200 cm).

GRAY 80 G

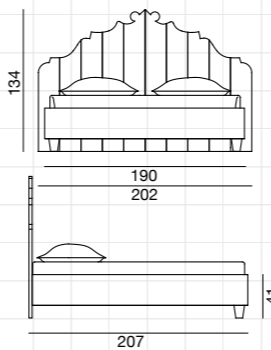

Letto, testiera in noce canaletto verniciato naturale o rovere laccato bianco, grigio, avio, nero. Giroletto in multistrati di legno imbottito con poliuretano espanso, con supporti rete regolabili. Rivestimento sfoderabile. Rete in opzione (180 x 200 cm).

Bed, headboard in natural lacquered American walnut or in white, grey, air force blue, black lacquered oak. Upholstered plywood bed frame, removable cover, adjustable slat supports. Slat on request (180 x 200 cm).

Bett, Kopfteil aus amerikanisches Nussbaum natur lasiert oder aus Eiche, weiß, grau, schieferblau, schwarz lackiert. Bettgestell aus Multischichtholz, gepolstert, abziehbar, verstellbare Lattenrostträger. Lattenrost auf Wunsch (180 x 200 cm).

Lit, tête de lit en noyer américain verni naturel ou bien en chêne laqué blanc, gris, bleu ardoise, noir. Structure en multipli rembourré, déhoussable, supports sommier réglables. Sommier optionnel (180 x 200 cm).

NEXT 05

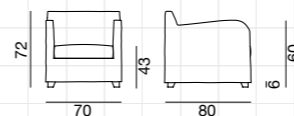

p. 102

Poltrona, imbottitura in poliuretano espanso. Rivestimento sfoderabile con cucitura taglia e cuci e fondo libero. Su richiesta con fondo velcrato. Piedi in fusione di alluminio lucidato, in noce Canaletto verniciato naturale o faggio laccato bianco, grigio, avio o nero.

Armchair, upholstered with polyurethane foams, removable cover with stitching and free fastening. On request with velcro fastening. Feet in cast polished aluminium, in natural lacquered American walnut or white, grey, air force blue, black lacquered beech.

Sessel, Polsterung aus Polyurethanschaum, abziehbar mit Overlock-Nähten (lose Ausführung). Auf Wunsch auch in straffer Ausführung. Füße aus Gussaluminium poliert, aus Nussbaum natur lasiert oder aus Buche, weiß, grau, schieferblau oder schwarz lackiert.

Fauteuil, rembourrage en mousse polyuréthane, déhoussable en finition libre avec surpiqûres. Disponible aussi en finition tendue. Pieds en fonte d'aluminium poli, en noyer américain verni naturel ou en hêtre laqué blanc, gris, bleu ardoise ou noir.

NEXT 05 P

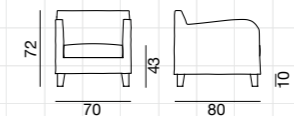

p. 84

Poltrona, imbottitura in poliuretano espanso. Rivestimento sfoderabile con piping e fondo velcrato. Su richiesta con fondo libero. Piedi in fusione di alluminio lucidato, in noce Canaletto verniciato naturale o faggio laccato bianco, grigio, avio o nero.

Armchair, upholstered with polyurethane foams, removable cover with piping and Velcro fastening. On request with free fastening. Feet in cast polished aluminium, in natural lacquered American walnut or white, grey, air force blue, black lacquered beech.

Sessel, Polsterung aus Polyurethanschaum, abziehbar mit Keder (straffe Ausführung). Auf Wunsch auch in loser Ausführung. Füße aus Gussaluminium poliert, aus Nussbaum natur lasiert oder aus Buche, weiß, grau, schieferblau oder schwarz lackiert.

Fauteuil, rembourrage en mousse polyuréthane, déhoussable en finition tendue avec passe poil. Disponible aussi en finition libre. Pieds en fonte d'aluminium poli, en noyer américain verni naturel ou en hêtre laqué blanc, gris, bleu ardoise ou noir.

NEXT 10



p. 103

Divano, imbottitura in poliuretano espanso. Rivestimento sfoderabile con cucitura taglia e cuci e fondo libero. Su richiesta con fondo velcrato. Piedi in fusione di alluminio lucidato, in noce Canaletto verniciato naturale o faggio laccato bianco, grigio, avio o nero. Cuscini volanti in misto piuma: due schienali da 60x60 cm.

Sofa, upholstered with polyurethane foams, removable cover with stitching and free fastening. On request with velcro fastening. Feet in cast polished aluminium, in natural lacquered American walnut or white, grey, air force blue, black lacquered beech. Two back cushions in Dacron and down 60x60 cm.

Sofa, Polsterung aus Polyurethanschaum, abziehbar mit Overlock-Nähten (lose Ausführung). Auf Wunsch auch in straffer Ausführung. Füße aus Gussaluminium poliert, aus Nussbaum natur lasiert oder aus Buche, weiß, grau, schieferblau oder schwarz lackiert. Zwei Rückenissen aus Dacron und Daunenfüllung 60x60 cm.

Canapé, rembourrage en mousse polyuréthane, déhoussable en finition libre avec surpiqûres. Disponible aussi en finition tendue. Pieds en fonte d'aluminium poli, en noyer américain verni naturel ou en hêtre laqué blanc, gris, bleu ardoise ou noir. Deux coussins dossier en dacron et plume 60x60 cm.

GRAY 80 S

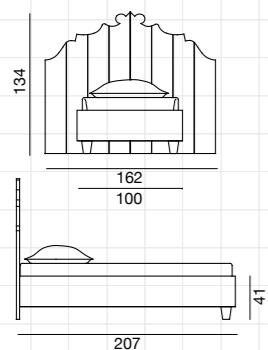

Letto, testiera in noce canaletto verniciato naturale o rovere laccato bianco, grigio, avio, nero. Giroletto in multistrati di legno imbottito con poliuretano espanso, con supporti rete regolabili. Rivestimento sfoderabile. Rete in opzione (90 x 200 cm).

Bed, headboard in natural lacquered American walnut or in white, grey, air force blue, black lacquered oak. Upholstered plywood bed frame, removable cover, adjustable slat supports. Slat on request (90 x 200 cm).

Bett, Kopfteil aus amerikanisches Nussbaum natur lasiert oder aus Eiche, weiß, grau, schieferblau, schwarz lackiert. Bettgestell aus Multischichtholz, gepolstert, abziehbar, verstellbare Lattenrostträger. Lattenrost auf Wunsch (90 x 200 cm).

Lit, tête de lit en noyer américain verni naturel ou bien en chêne laqué blanc, gris, bleu ardoise, noir. Structure en multipli rembourré, déhoussable, supports sommier réglables. Sommier optionnel (90 x 200 cm).

NEXT 01

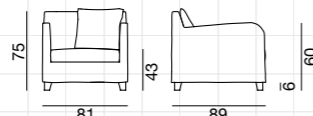

p. 78

Poltrona, imbottitura in poliuretano espanso. Rivestimento sfoderabile con cucitura taglia e cuci e fondo libero. Su richiesta con fondo velcrato. Piedi in fusione di alluminio lucidato, in noce Canaletto verniciato naturale o faggio laccato bianco, grigio, avio o nero. Un cuscino volante in misto piuma 50x50 cm.

Armchair, upholstered with polyurethane foams, removable cover with stitching and free fastening. On request with velcro fastening. Feet in cast polished aluminium, in natural lacquered American walnut or white, grey, air force blue, black lacquered beech. One back cushion in Dacron and down 50x50 cm.

Sessel, Polsterung aus Polyurethanschaum, abziehbar mit Keder (straffe Ausführung). Auf Wunsch auch in loser Ausführung. Füße aus Gussaluminium poliert, aus Nussbaum natur lasiert oder aus Buche, weiß, grau, schieferblau oder schwarz lackiert. Ein Rückenissen aus Dacron und Daunenfüllung 50x50 cm.

Fauteuil, rembourrage en mousse polyuréthane, déhoussable en finition libre avec surpiqûres. Disponible aussi en finition tendue. Pieds en fonte d'aluminium poli, en noyer américain verni naturel ou en hêtre laqué blanc, gris, bleu ardoise ou noir. Un coussin dossier en dacron et plume 50x50 cm.

NEXT 01 P

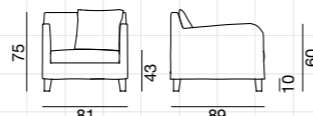

Poltrona, imbottitura in poliuretano espanso. Rivestimento sfoderabile con piping e fondo velcrato. Su richiesta con fondo libero. Piedi in fusione di alluminio lucidato, in noce Canaletto verniciato naturale o faggio laccato bianco, grigio, avio o nero. Un cuscino volante in misto piuma 50x50 cm.

Armchair, upholstered with polyurethane foams, removable cover with piping and Velcro fastening. On request with free fastening. Feet in cast polished aluminium, in natural lacquered American walnut or white, grey, air force blue, black lacquered beech. One back cushion in Dacron and down 50x50 cm.

Sessel, Polsterung aus Polyurethanschaum, abziehbar mit Keder (straffe Ausführung). Auf Wunsch auch in loser Ausführung. Füße aus Gussaluminium poliert, aus Nussbaum natur lasiert oder aus Buche, weiß, grau, schieferblau oder schwarz lackiert. Ein Rückenissen aus Dacron und Daunenfüllung 50x50 cm.

Fauteuil, rembourrage en mousse polyuréthane, déhoussable en finition tendue avec passe poil. Disponible aussi en finition libre. Pieds en fonte d'aluminium poli, en noyer américain verni naturel ou en hêtre laqué blanc, gris, bleu ardoise ou noir. Un coussin dossier en dacron et plume 50x50 cm.

NEXT 10 P

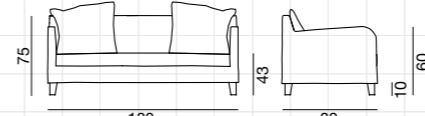

Divano, imbottitura in poliuretano espanso. Rivestimento sfoderabile con piping e fondo velcrato. Su richiesta con fondo libero. Piedi in fusione di alluminio lucidato, in noce Canaletto verniciato naturale o faggio laccato bianco, grigio, avio o nero. Cuscini volanti in misto piuma: due schienali da 60x60 cm.

Sofa, upholstered with polyurethane foams, removable cover with piping and Velcro fastening. On request with free fastening. Feet in cast polished aluminium, in natural lacquered American walnut or white, grey, air force blue, black lacquered beech. Two back cushions in Dacron and down 60x60 cm.

Sofa, Polsterung aus Polyurethanschaum, abziehbar mit Keder (straffe Ausführung). Auf Wunsch auch in loser Ausführung. Füße aus Gussaluminium poliert, aus Nussbaum natur lasiert oder aus Buche, weiß, grau, schieferblau oder schwarz lackiert. Zwei Rückenissen aus Dacron und Daunenfüllung 60x60 cm.

Canapé, rembourrage en mousse polyuréthane, déhoussable en finition tendue avec passe poil. Disponible aussi en finition libre. Pieds en fonte d'aluminium poli, en noyer américain verni naturel ou en hêtre laqué blanc, gris, bleu ardoise ou noir. Deux coussins dossier en dacron et plume 60x60 cm.

NEXT 12

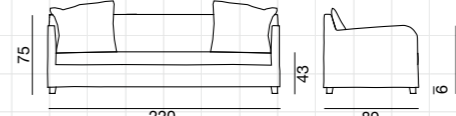

p. 4-5 / 8 / 93

Divano, imbottitura in poliuretano espanso. Rivestimento sfoderabile con cucitura taglia e cuci e fondo libero. Su richiesta con fondo velcrato. Piedi in fusione di alluminio lucidato, in noce Canaletto verniciato naturale o faggio laccato bianco, grigio, avio o nero. Cuscini volanti in misto piuma: due schienali da 60x60 cm.

Sofa, upholstered with polyurethane foams, removable cover with stitching and free fastening. On request with velcro fastening. Feet in cast polished aluminium, in natural lacquered American walnut or white, grey, air force blue, black lacquered beech. Two back cushions in Dacron and down 60x60 cm.

Sofa, Polsterung aus Polyurethanschaum, abziehbar mit Overlock-Nähten (lose Ausführung). Auf Wunsch auch in straffer Ausführung. Füße aus Gussaluminium poliert, aus Nussbaum natur lasiert oder aus Buche, weiß, grau, schieferblau oder schwarz lackiert. Zwei Rückenissen aus Dacron und Daunenfüllung 60x60 cm.

Canapé, rembourrage en mousse polyuréthane, déhoussable en finition libre avec surpiqûres. Disponible aussi en finition tendue. Pieds en fonte d'aluminium poli, en noyer américain verni naturel ou en hêtre laqué blanc, gris, bleu ardoise ou noir. Deux coussins dossier en dacron et plume 60x60 cm.

NEXT 12 P

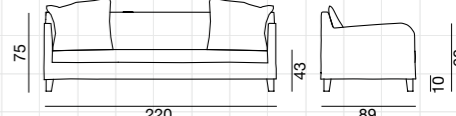

p. 34-35

Divano, imbottitura in poliuretano espanso. Rivestimento sfoderabile con piping e fondo velcrato. Su richiesta con fondo libero. Piedi in fusione di alluminio lucidato, in noce Canaletto verniciato naturale o faggio laccato bianco, grigio, avio o nero. Cuscini volanti in misto piuma: due schienali da 60x60 cm.

Sofa, upholstered with polyurethane foams, removable cover with piping and Velcro fastening. On request with free fastening. Feet in cast polished aluminium, in natural lacquered American walnut or white, grey, air force blue, black lacquered beech. Two back cushions in Dacron and down 60x60 cm.

Sofa, Polsterung aus Polyurethanschaum, abziehbar mit Keder (straffe Ausführung). Auf Wunsch auch in loser Ausführung. Füße aus Gussaluminium poliert, aus Nussbaum natur lasiert oder aus Buche, weiß, grau, schieferblau oder schwarz lackiert. Zwei Rückenissen aus Dacron und Daunenfüllung 60x60 cm.

Canapé, rembourrage en mousse polyuréthane, déhoussable en finition tendue avec passe poil. Disponible aussi en finition libre. Pieds en fonte d'aluminium poli, en noyer américain verni naturel ou en hêtre laqué blanc, gris, bleu ardoise ou noir. Deux coussins dossier en dacron et plume 60x60 cm.



## NEXT 16

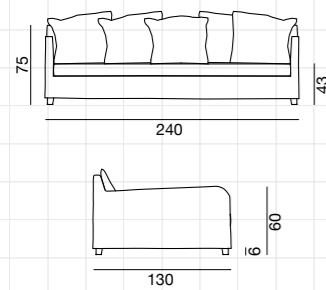

p. 92 / 94

Divano, imbottitura in poliuretano espanso. Rivestimento sfoderabile con cucitura taglia e cuci e fondo libero. Su richiesta con fondo veltrato. Piedi in fusione di alluminio lucidato, in noce Canaletto verniciato naturale o faggio laccato bianco, grigio, avio o nero. Cuscini volanti in misto piuma: 5 schienali da 60x60 cm.

Sofa, upholstered with polyurethane foams, removable cover with stitching and free fastening. On request with velcro fastening. Feet in cast polished aluminium, in natural lacquered American walnut or white, grey, air force blue, black lacquered beech. Five back cushions in Dacron and down 60x60 cm.

Sofa, Polsterung aus Polyurethanschaum, abziehbar mit Overlock-Nähten (lose Ausführung). Auf Wunsch auch in straffer Ausführung. Füße aus Gussaluminium poliert, aus Nussbaum natur lasiert oder aus Buche, weiß, grau, schieferblau oder schwarz lackiert. Fünf Rückenissen aus Dacron und Daunenfüllung 60x60 cm.

Canapé, rembourrage en mousse polyuréthane, déhoussable en finition libre avec surpiqûres. Disponible aussi en finition tendue. Pieds en fonte d'aluminium poli, en noyer américain verni naturel ou en hêtre laqué blanc, gris, bleu ardoise ou noir. Cinq coussins dossier en dacron et plume 60x60 cm.

## NEXT 16 P

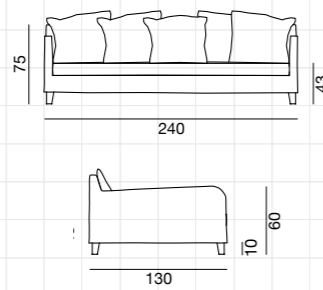

p. 51

Divano, imbottitura in poliuretano espanso. Rivestimento sfoderabile con piping e fondo veltrato. Su richiesta con fondo libero. Piedi in fusione di alluminio lucidato, in noce Canaletto verniciato naturale o faggio laccato bianco, grigio, avio o nero. Cuscini volanti in misto piuma: 5 schienali da 60x60 cm.

Sofa, upholstered with polyurethane foams, removable cover with piping and Velcro fastening. On request with free fastening. Feet in cast polished aluminium, in natural lacquered American walnut or white, grey, air force blue, black lacquered beech. Five back cushions in Dacron and down 60x60 cm.

Sofa, Polsterung aus Polyurethanschaum, abziehbar mit Keder (straffe Ausführung). Auf Wunsch auch in loser Ausführung. Füße aus Gussaluminium poliert, aus Nussbaum natur lasiert oder aus Buche, weiß, grau, schieferblau oder schwarz lackiert. Fünf Rückenissen aus Dacron und Daunenfüllung 60x60 cm.

Canapé, rembourrage en mousse polyuréthane, déhoussable en finition tendue avec passe poil. Disponible aussi en finition libre. Pieds en fonte d'aluminium poli, en noyer américain verni naturel ou en hêtre laqué blanc, gris, bleu ardoise ou noir. Cinq coussins dossier en dacron et plume 60x60 cm.

## NEXT 20 L-R

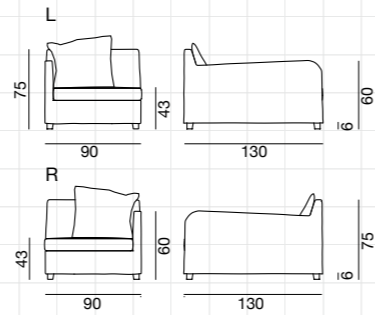

p. 14-15

Dormeuse, imbottitura in poliuretano espanso, un bracciolo destro (R) o sinistro (L). Rivestimento sfoderabile con cucitura taglia e cuci e fondo libero. Su richiesta con fondo veltrato. Piedi in fusione di alluminio lucidato, in noce Canaletto verniciato naturale o faggio laccato bianco, grigio, avio o nero. Un cuscino volante in misto piuma 60x60 cm.

Dormeuse, upholstered with polyurethane foams, one right (R) or left (L) armrest. Removable cover with stitching and free fastening. On request with velcro fastening. Feet in cast polished aluminium, in natural lacquered American walnut or white, grey, air force blue, black lacquered beech. One back cushion in Dacron and down 60x60 cm.

Diwan, Polsterung aus Polyurethanschaum, eine Armlehne rechts (R) oder links (L), abziehbar mit Overlock-Nähten (lose Ausführung). Auf Wunsch auch in straffer Ausführung. Füße aus Gussaluminium poliert, aus Nussbaum natur lasiert oder aus Buche, weiß, grau, schieferblau oder schwarz lackiert. Ein Rückenissen aus Dacron und Daunenfüllung 60x60 cm.

Meridienne, rembourrage en mousse polyuréthane, un accoudoir à droite (R) ou bien à gauche (L), déhoussable en finition libre avec surpiqûres. Disponible aussi en finition tendue. Pieds en fonte d'aluminium poli, en noyer américain verni naturel ou en hêtre laqué blanc, gris, bleu ardoise ou noir. Un coussin dossier en dacron et plume 60x60 cm.

## NEXT 27

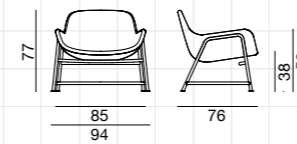

p. 30-31 / 66 / 68

Poltrona intrecciata in midollino naturale o laccato bianco opaco, grigio, avio, nero. Base in acciaio verniciato bianco opaco.

Handwoven armchair in natural rattan core with matt white steel frame. Available also matt white, grey, blue or black lacquered rattan core.

Sessel aus naturbelassenem Peddigrohr geflochten. Gestell aus matt weißem lackierten Stahl. Lieferbar auch in matt weiß, grau, schieferblau, schwarz lackiertem Peddigrohr.

Fauteuil en rotin naturel tressé, structure en acier laqué blanc mat. Disponible aussi en rotin laqué blanc mat, gris, bleu ardoise et noir.

## NEXT 132

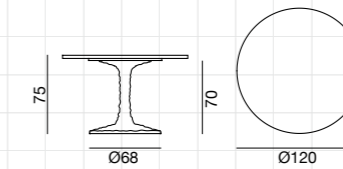

p. 91

Table rotondo, gamba centrale in fusione di alluminio lucidato. Piano disponibile in HPL serigrafato, marmo bianco Carrara o legno. Finiture legno disponibili: noce Canaletto/rovere verniciato naturale o rovere laccato bianco, grigio, avio, nero.

Round table, cast polished aluminium central base. Plain fixed top in decorated HPL, white Carrara marble or wood. Available wood finishes: natural lacquered American walnut/oak; white, grey, air force blue or black lacquered oak.

Runder Tisch, Fuß aus Gussaluminium poliert. Lieferbar mir Platte aus HPL-Laminat, Marmor oder Holz. Lieferbare Holz Ausführungen: amerikanisches Nussbaum / Eiche natur lasiert, Eiche weiß, grau, schieferblau, schwarz lackiert.

Table ronde, pied en fonte d'aluminium poli. Plateau en stratifié HPL, marbre ou bois. Finitions du bois disponibles: noyer américain / chêne vernis naturel, chêne laqué blanc, gris, bleu ardoise ou noir.

## NEXT 136

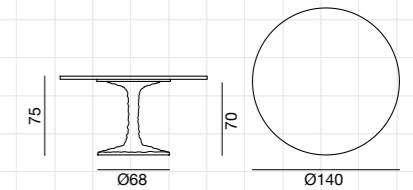

p. 22

Table rotondo, gamba centrale in fusione di alluminio lucidato. Piano disponibile in HPL serigrafato, marmo bianco Carrara o legno. Finiture legno disponibili: noce Canaletto/rovere verniciato naturale o rovere laccato bianco, grigio, avio, nero.

Round table, cast polished aluminium central base. Plain fixed top in decorated HPL, white Carrara marble or wood. Available wood finishes: natural lacquered American walnut/oak; white, grey, air force blue or black lacquered oak.

Runder Tisch, Fuß aus Gussaluminium poliert. Lieferbar mir Platte aus HPL-Laminat, Marmor oder Holz. Lieferbare Holz Ausführungen: amerikanisches Nussbaum / Eiche natur lasiert, Eiche weiß, grau, schieferblau, schwarz lackiert.

Table ronde, pied en fonte d'aluminium poli. Plateau en stratifié HPL, marbre ou bois. Finitions du bois disponibles: noyer américain / chêne vernis naturel, chêne laqué blanc, gris, bleu ardoise ou noir.

## NEXT 20 P L-R

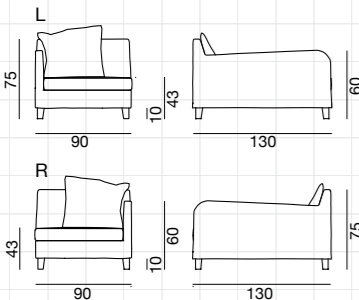

p. 35 / 37 / 71

Dormeuse, imbottitura in poliuretano espanso, un bracciolo destro (R) o sinistro (L). Rivestimento sfoderabile con piping e fondo veltrato. Su richiesta con fondo libero. Piedi in fusione di alluminio lucidato, in noce Canaletto verniciato naturale o faggio laccato bianco, grigio, avio o nero. Un cuscino volante in misto piuma 60x60 cm.

Dormeuse, upholstered with polyurethane foams, one right (R) or left (L) armrest. Removable cover with piping and Velcro fastening. On request with free fastening. Feet in cast polished aluminium, in natural lacquered American walnut or white, grey, air force blue, black lacquered beech. One back cushion in Dacron and down 60x60 cm.

Diwan, Polsterung aus Polyurethanschaum, eine Armlehne rechts (R) oder links (L), abziehbar mit Keder (straffe Ausführung). Auf Wunsch auch in loser Ausführung. Füße aus Gussaluminium poliert, aus Nussbaum natur lasiert oder aus Buche, weiß, grau, schieferblau oder schwarz lackiert. Ein Rückenissen aus Dacron und Daunenfüllung 60x60 cm.

Meridienne, rembourrage en mousse polyuréthane, un accoudoir à droite (R) ou bien à gauche (L), déhoussable en finition tendue avec passe poil. Disponible aussi en finition libre. Pieds en fonte d'aluminium poli, en noyer américain verni naturel ou en hêtre laqué blanc, gris, bleu ardoise ou noir. Un coussin dossier en dacron et plume 60x60 cm.

## NEXT 23

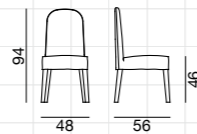

p. 22 / 82-83 / 97

Sedia, struttura in noce, seduta e schienale imbottiti in poliuretano espanso. Rivestimento sfoderabile con cucitura taglia e cuci e fondo libero. Finiture legno disponibili: noce Canaletto verniciato naturale o laccato bianco, grigio, avio, nero.

Side chair in walnut, upholstered seat and back in polyurethane foam, removable cover with stitching and free fastening. Available wood finishes: natural, white, grey, air force blue, black lacquered American walnut.

Stuhl aus Nussbaum oder Eiche, gepolsterte Sitz und Rückenlehne, abziehbar mit Overlock-Nähten (lose Ausführung). Lieferbare Holz Ausführungen: amerikanisches Nussbaum natur lasiert oder weiss, grau, schieferblau, schwarz lackiert.

Chaise en noyer ou chêne, assise et dossier rembourrés en mousse polyuréthane, déhoussable en finition libre avec surpiqûres. Finitions du bois disponibles: noyer américain vernis naturel ou laqué blanc, gris, bleu ardoise, noir.

## NEXT 24

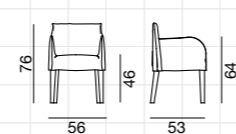

p. 42-43

Sedia con braccioli, struttura in noce, seduta e schienale imbottiti in poliuretano espanso. Rivestimento sfoderabile con cucitura taglia e cuci e fondo libero. Finiture legno disponibili: noce Canaletto verniciato naturale o laccato bianco, grigio, avio, nero.

Armchair, upholstered seat and back in polyurethane foam, removable cover with stitching and free fastening. Available wood finishes: natural, white, grey, air force blue, black lacquered American walnut.

Armlehnstuhl, gepolsterte Sitz und Rückenlehne, abziehbar mit Overlock-Nähten (lose Ausführung). Lieferbare Holz Ausführungen: amerikanisches Nussbaum natur lasiert oder weiss, grau, schieferblau, schwarz lackiert.

Bridge en noyer ou chêne, assise et dossier rembourrés en mousse polyuréthane, déhoussable en finition libre avec surpiqûres. Finitions du bois disponibles: noyer américain vernis naturel ou laqué blanc, gris, bleu ardoise, noir.

## NEXT 137

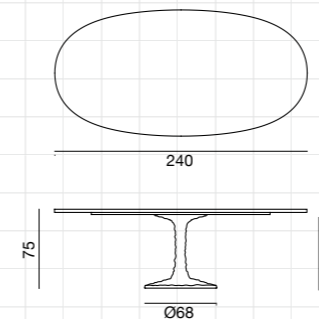

p. 52 / 53

Table ovale, gamba centrale in fusione di alluminio lucidato. Piano disponibile in HPL serigrafato, marmo bianco Carrara o legno. Finiture legno disponibili: noce Canaletto/rovere verniciato naturale o rovere laccato bianco, grigio, avio, nero.

Oval table, cast polished aluminium central base. Plain fixed top in decorated HPL, white Carrara marble or wood. Available wood finishes: natural lacquered American walnut/oak; white, grey, air force blue or black lacquered oak.

Ovaler Tisch, Fuß aus Gussaluminium poliert. Lieferbar mir Platte aus HPL-Laminat, Marmor oder Holz. Lieferbare Holz Ausführungen: amerikanisches Nussbaum / Eiche natur lasiert, Eiche weiß, grau, schieferblau, schwarz lackiert.

Table ovale, pied en fonte d'aluminium poli. Plateau en stratifié HPL, marbre ou bois. Finitions du bois disponibles: noyer américain / chêne vernis naturel, chêne laqué blanc, gris, bleu ardoise ou noir.

## NEXT 138

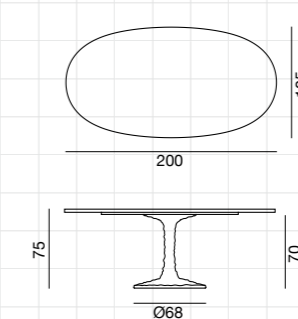

p. 97

Table ovale, gamba centrale in fusione di alluminio lucidato. Piano disponibile in HPL serigrafato, marmo bianco Carrara o legno. Finiture legno disponibili: noce Canaletto/rovere verniciato naturale o rovere laccato bianco, grigio, avio, nero.

Oval table, cast polished aluminium central base. Plain fixed top in decorated HPL, white Carrara marble or wood. Available wood finishes: natural lacquered American walnut/oak; white, grey, air force blue or black lacquered oak.

Ovaler Tisch, Fuß aus Gussaluminium poliert. Lieferbar mir Platte aus HPL-Laminat, Marmor oder Holz. Lieferbare Holz Ausführungen: amerikanisches Nussbaum / Eiche natur lasiert, Eiche weiß, grau, schieferblau, schwarz lackiert.

Table ovale, pied en fonte d'aluminium poli. Plateau en stratifié HPL, marbre ou bois. Finitions du bois disponibles: noyer américain / chêne vernis naturel, chêne laqué blanc, gris, bleu ardoise ou noir.

## NEXT 141 / 142 / 144

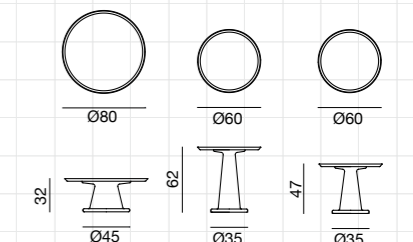

p. 4-5 / 6-7 / 8 / 92-93 / 94

Table rotondo, gamba centrale in fusione di alluminio lucidato.

Coffee / side table, frame and top in cast polished aluminium.

Couch - Beistelltisch, Fuß und Platte aus Gussaluminium poliert.

Table basse / guéridon, structure et pied en fonte d'aluminium poli.

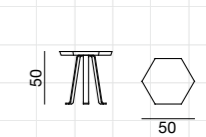
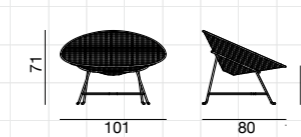
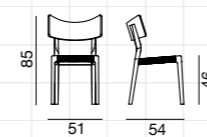
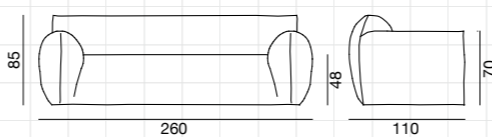
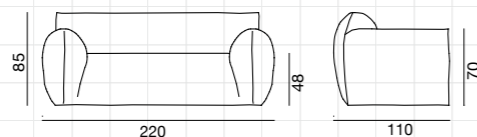
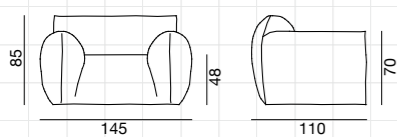

p. 72 / 73

Poltrona, struttura in multistrati e massello, imbottitura in poliuretano espanso a quote differenziate rivestita con trapuntino imbottito con piuma d'oca e fiocco di fibra di poliestere, rivestimento sfoderabile.

Lounge chair, multilayer and solid wood frame, upholstered with differentiated density polyurethane foam covered by a goose down and polyester fibre quilting, removable cover.

Sessel, Gestell aus Multischicht- und Massivholz. Polsterung aus Polyurethanschäum differenzierter Dichte, Weißpolsterbezug gefüllt mit Daunen und Polyesterflöckchen.

Fauteuil déhoussable, structure en multiplis et bois massif, rembourrage en mousse polyuréthane à densité différenciée avec couche ultérieure en duvet et polyester.

Divano, struttura in multistrati e massello, imbottitura in poliuretano espanso a quote differenziate rivestita con trapuntino imbottito con piuma d'oca e fiocco di fibra di poliestere, rivestimento sfoderabile.

Sofa, multilayer and solid wood frame, upholstered with differentiated density polyurethane foam covered by a goose down and polyester fibre quilting, removable cover.

Abziehbares Sofa, Gestell aus Multischicht- und Massivholz. Polsterung aus Polyurethanschäum differenzierter Dichte, Weißpolsterbezug gefüllt mit Daunen und Polyesterflöckchen.

Canapé déhoussable, structure en multiplis et bois massif, rembourrage en mousse polyuréthane à densité différenciée avec couche ultérieure en duvet et polyester.

p. 24-25 / 58

Divano, struttura in multistrati e massello, imbottitura in poliuretano espanso a quote differenziate rivestita con trapuntino imbottito con piuma d'oca e fiocco di fibra di poliestere, rivestimento sfoderabile.

Sofa, multilayer and solid wood frame, upholstered with differentiated density polyurethane foam covered by a goose down and polyester fibre quilting, removable cover.

Abziehbares Sofa, Gestell aus Multischicht- und Massivholz. Polsterung aus Polyurethanschäum differenzierter Dichte, Weißpolsterbezug gefüllt mit Daunen und Polyesterflöckchen.

Canapé déhoussable, structure en multiplis et bois massif, rembourrage en mousse polyuréthane à densité différenciée avec couche ultérieure en duvet et polyester.

p. 64 / 97 / 105

Sedia con struttura in noce Canaletto, seduta e schienale intrecciati in PVC bianco o nero (Sweet 21) o seduta in cuoio marrone (Sweet 21 C). Finiture legno disponibili: noce Canaletto verniciato naturale, laccato bianco, grigio, avio, nero.

Chair in American walnut, seat and back woven with white or black PVC rope (Sweet 21) or seat in brown leather (Sweet 21 C). Available wood finishes: natural, white, grey, air force blue, black lacquered American walnut.

Stuhl aus amerikanischem Nussbaum, Sitz mit weißer oder schwarzer PVC-Bespannung (Sweet 21) oder aus braunem Kernleder (Sweet 21 C). Lieferbare Holz Ausführungen: amerikanisches Nussbaum natur lasiert, weiß, grau, schieferblau, schwarz lackiert.

Chaise en noyer américain, assise tressée en PVC blanc ou noir (Sweet 21) ou bien garnie en cuir marron (Sweet 21 C). Finitions du bois disponibles: noyer américain verni naturel, laqué blanc, gris, bleu ardoise, noir.

p. 59 / 102

Poltrona, struttura in tubo di metallo verniciato a polveri nero opaco con scocca intrecciata in PVC nero opaco. Disponibile anche in PVC bianco lucido con struttura bianca.

Armchair, matt black lacquered metal frame woven with matt black PVC. Available also in glossy white PVC with white frame.

Sessel, Metallgestell, matt schwarz lackiert, mit matt schwarzem PVC geflochten. Erhältlich auch in der Ausführung glänzend weiß mit weißem Gestell.

Fauteuil, structure en métal laqué noir mat, coque tressée en PVC noir mat. Disponible aussi en PVC blanc brillant avec structure blanche.

p. 45 / 58 / 68 / 93

Tavolino, piano esagonale, gambe in acciaio spazzolato o laccato bianco. Finiture piano: bambù pressato a doghe bianco, grigio, avio, nero; noce Canaletto verniciato naturale o laccato bianco, grigio, avio o nero.

Side table, hexagonal top, brushed steel or white lacquered metal feet. Available top finishes: white, grey, air force blue or black bamboo lamination; natural, white, grey, air force blue, black lacquered American walnut.

Beistelltisch, sechseckige Platte, Füße aus gebürstetem Stahl oder weiß lackiert. Lieferbare Platten: weißes, graues, schieferblaues oder schwarzes Bambusfurnier; amerikanisches Nussbaum natur lasiert oder weiß, grau, schwarz, schieferblau lackiert.

Guéridon, dessus hexagonale, pieds en acier brossé ou laqués blanc. Finitions dessus: placage de bambou blanc, gris, noir, bleu ardoise; noyer américain verni naturel ou bien laqué blanc, gris, noir, bleu ardoise.

SPIN S / M / L

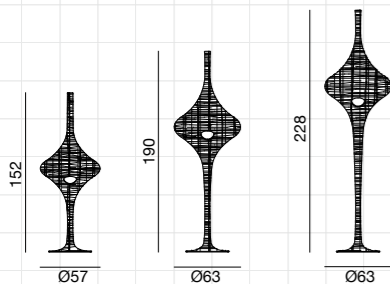

p. 93 / 96

Lampada da terra in midollino naturale mélange o laccato bianco opaco, grigio, avio, nero; completa di cablaggio, 18 W, 220 Volt, attacco E27, lampadina non fornita. Disponibile anche 110 Volt, spina USA.

Floor standing lamp in natural melange rattan core, with wiring, 18 W, 220 Volt, bulb holder E 27, bulb not included. On request, 110 Volt, US plug. Available also in matt white, grey, blue or black lacquered rattan core.

Stehleuchte aus naturbelassenem Peddigrohr, mit Verkabelung, 18 W, 220 Volt, Lampenfassung E 27, Birne nicht mitgeliefert. Erhältlich auch 110 Volt, US Stecker. Lieferbar auch in matt weiß, grau, schieferblau, schwarz lackiertem Peddigrohr.

Lampadaire en rotin naturel tressé avec câblage, 18 W, 220 Volt, douille de lampe E 27, disponible aussi 110 Volt, fiche américaine, ampoule non fournie; disponible aussi en rotin laqué blanc mat, gris, bleu ardoise et noir.

SPIN 95 / 96

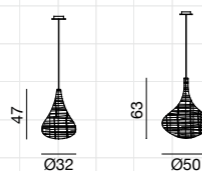

p. 39 / 66 / 69 / 87

Lampada a sospensione in midollino naturale mélange o laccato bianco opaco, grigio, avio, nero; completa di cablaggio, 18 W, 220 Volt, lampadina non fornita.

Suspension lamp in natural melange rattan core, with wiring 18 W, 220 Volt, bulb not included. Available also matt white, grey, blue or black lacquered rattan core.

Deckenleuchte aus naturbelassenem Peddigrohr, mit Verkabelung, 18 W, 220 Volt, Birne nicht mitgeliefert. Lieferbar auch in matt weiß, grau, schieferblau, schwarz lackiertem Peddigrohr.

Suspension en rotin naturel tressé avec câblage, 18 W, 220 Volt, ampoule non fournie; disponible aussi en rotin laqué blanc mat, gris, bleu ardoise et noir.

SWEET 20

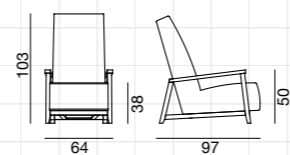

p. 44-45 / 49 / 50

Poltrona in noce, seduta e schienale in legno con imbottitura in poliuretano espanso, rivestimento sfoderabile. Finiture legno disponibili: noce Canaletto verniciato naturale, laccato bianco, grigio, avio, nero.

Armchair in walnut, seat and back upholstered with polyurethane foams, removable cover. Available wood finishes: natural, white, grey, air force blue, black lacquered American walnut.

Sessel aus Nussbaum, Sitz und Rücken aus Polyurethanschäum, abziehbar. Lieferbare Holz ausföhrungen: amerikanisches Nussbaum natur lasiert, weiß, grau, schieferblau, schwarz lackiert.

Fauteuil en noyer, assise et dossier rembourrés, déhoussables. Finitions du bois disponibles: noyer américain verni naturel, laqué blanc, gris, bleu ardoise, noir.

SWEET 46

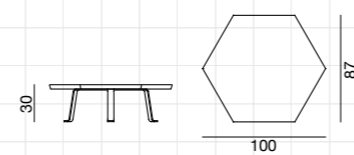

p. 59 / 93

Tavolino, piano esagonale, gambe in acciaio spazzolato o laccato bianco. Finiture piano: bambù pressato a doghe bianco, grigio, avio, nero; noce Canaletto verniciato naturale o laccato bianco, grigio, avio o nero.

Coffee table, hexagonal top, brushed steel or white lacquered metal feet. Available top finishes: white, grey, air force blue or black bamboo lamination; natural, white, grey, air force blue, black lacquered American walnut.

Couchtisch, sechseckige Platte, Füße aus gebürstetem Stahl oder weiß lackiert. Lieferbare Platten: weißes, graues, schieferblaues oder schwarzes Bambusfurnier; amerikanisches Nussbaum natur lasiert oder weiß, grau, schwarz, schieferblau lackiert.

Table basse, dessus hexagonale, pieds en acier brossé ou laqués blanc. Finitions dessus: placage de bambou blanc, gris, noir, bleu ardoise; noyer américain verni naturel ou bien laqué blanc, gris, noir, bleu ardoise.

SWEET 51  
251 / 351 / 451 / 551

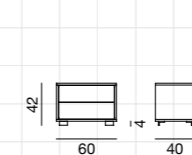

p. 67 / 69

Comodino in noce, due cassetti, piedini in acciaio spazzolato o laccato bianco. Finiture struttura: noce Canaletto verniciato naturale (51), laccato bianco (251), grigio (351), avio (451), nero (551). Finiture frontali cassetto: bambù pressato a doghe bianco, grigio, avio, nero; noce Canaletto verniciato naturale; laccato bianco, grigio, avio o nero.

Night table in walnut, two drawers, brushed steel or white lacquered metal feet. Available frame finishes: natural (51), white (251), grey (351), air force blue (451), black (551) lacquered American walnut. Available front finishes: white, grey, air force blue, black bamboo lamination; natural, white, grey, air force blue, black lacquered American walnut.

Nachtisch aus Nussbaum, zwei Schubladen, Füße aus gebürstetem Stahl oder weiß lackiert. Korpusausföhrungen: amerikanisches Nussbaum natur lasiert (51); weiß (251), grau (351), schieferblau (451), schwarz (551) lackiert. Frontausföhrungen: weißes, graues, schieferblaues oder schwarzes Bambusfurnier; amerikanisches Nussbaum natur lasiert; Nussbaum weiß, grau, schieferblau, schwarz lackiert.

Chevet en noyer, deux tiroirs, pieds en acier brossé ou bien laqués blanc. Finitions structure: noyer américain verni naturel (51), laqué blanc (251), gris (351), bleu ardoise (451), noir (551). Finitions faces: placage de bambou blanc, gris, bleu ardoise, noir; noyer américain verni naturel, laqué blanc, gris, bleu ardoise, noir.

SWEET 61  
261 / 361 / 461 / 561



p. 30-31

Mobile contenitore in noce, tre cassetti, piedini in acciaio spazzolato o laccato bianco. Finiture struttura: noce Canaletto verniciato naturale (61), laccato bianco (261), grigio (361), avio (461), nero (561). Finiture frontali cassetto: bambù pressato a doghe bianco, grigio, avio, nero; noce Canaletto verniciato naturale; laccato bianco, grigio, avio o nero.

Storage unit in walnut, three drawers, brushed steel or white lacquered metal feet. Available frame finishes: natural (61), white (261), grey (361), air force blue (461), black (561) lacquered American walnut. Available front finishes: white, grey, air force blue, black bamboo lamination; natural, white, grey, air force blue, black lacquered American walnut.

Anrichte aus Nussbaum, drei Schubladen, Füße aus gebürstetem Stahl oder weiß lackiert. Korpusausföhrungen: amerikanisches Nussbaum natur lasiert (61); Nussbaum matt weiß (261), grau (361), schieferblau (461), schwarz (561) lackiert. Frontausföhrungen: weißes, graues, schieferblaues oder schwarzes Bambusfurnier; amerikanisches Nussbaum natur lasiert; Nussbaum weiß, grau, schieferblau, schwarz lackiert.

Bahut bas en noyer, trois tiroirs, pieds en acier brossé ou bien laqués blanc. Finitions structure: noyer américain verni naturel (61), noyer laqué blanc (261), gris (361), bleu ardoise (461), noir (561). Finitions faces: placage de bambou blanc, gris, bleu ardoise, noir; noyer américain verni naturel, laqué blanc, gris, bleu ardoise, noir.

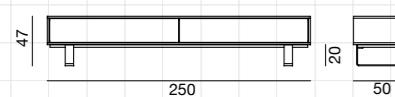

p. 26-27

Cassettiera in noce, due cassetti, piedini in acciaio spazzolato o laccato bianco. Finiture struttura: noce Canaletto verniciato naturale (62), laccato bianco (262), grigio (362), avio (462), nero (562). Finiture frontali cassetto: bambù pressato a doghe bianco, grigio, avio, nero; noce Canaletto verniciato naturale; laccato bianco, grigio, avio o nero.

Chest of drawers in walnut, two drawers, brushed steel or white lacquered metal feet. Available frame finishes: natural (62), white (262), grey (362), air force blue (462), black (562) lacquered American walnut. Available front finishes: white, grey, air force blue, black bamboo lamination; natural, white, grey, air force blue, black lacquered American walnut.

Kommode aus Nussbaum, zwei Schubladen, Füße aus gebürstetem Stahl oder weiß lackiert. Korpusausführungen: amerikanisches Nussbaum natur lasiert (62); weiß (262), grau (362), schieferblau (462), schwarz (562) lackiert. Frontausführungen: weißes, graues, schieferblaues oder schwarzes Bambusfurnier; amerikanisches Nussbaum natur lasiert; Nussbaum weiß, grau, schieferblau, schwarz lackiert.

Commode en noyer, deux tiroirs, pieds en acier brossé ou bien laqués blanc. Finitions structure: noyer américain verni naturel (62), noyer laqué blanc (262), gris (362), bleu ardoise (462), noir (562). Finitions faces: placage de bambou blanc, gris, bleu ardoise, noir; noyer américain verni naturel, laqué blanc, gris, bleu ardoise, noir.

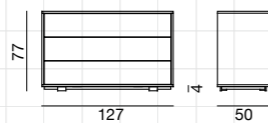

p. 85 / 86

Cassettiera in noce, tre cassetti, piedini in acciaio spazzolato o laccato bianco. Finiture struttura: noce Canaletto verniciato naturale (63), laccato bianco (263), grigio (363), avio (463), nero (563). Finiture frontali cassetto: bambù pressato a doghe bianco, grigio, avio, nero; noce Canaletto verniciato naturale; laccato bianco, grigio, avio o nero.

Chest of drawers in walnut, three drawers, brushed steel or white lacquered metal feet. Available frame finishes: natural (63), white (263), grey (363), air force blue (463), black (563) lacquered American walnut. Available front finishes: white, grey, air force blue, black bamboo lamination; natural, white, grey, air force blue, black lacquered American walnut.

Kommode aus Nussbaum, drei Schubladen, Füße aus gebürstetem Stahl oder weiß lackiert. Korpusausführungen: amerikanisches Nussbaum natur lasiert (63); Nussbaum weiß (263), grau (363), schieferblau (463), schwarz (563) lackiert. Frontausführungen: weißes, graues, schieferblaues oder schwarzes Bambusfurnier, amerikanisches Nussbaum natur lasiert; Nussbaum weiß, grau, schieferblau, schwarz lackiert.

Commode en noyer, trois tiroirs, pieds en acier brossé ou bien laqués blanc. Finitions structure: noyer américain verni naturel (63), noyer laqué blanc (263), gris (363), bleu ardoise (463), noir (563). Finitions faces: placage de bambou blanc, gris, bleu ardoise, noir; noyer américain verni naturel, laqué blanc, gris, bleu ardoise, noir.

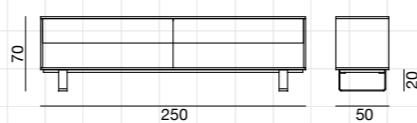

p. 73 / 75

Cassettiera in noce, quattro cassetti, piedini in acciaio spazzolato o laccato bianco. Finiture struttura: noce Canaletto verniciato naturale (64), laccato bianco (264), grigio (364), avio (464), nero (564). Finiture frontali cassetto: bambù pressato a doghe bianco, grigio, avio, nero; noce Canaletto verniciato naturale; laccato bianco, grigio, avio o nero.

Chest of drawers in walnut, four drawers, brushed steel or white lacquered metal feet. Available frame finishes: natural (64), white (264), grey (364), air force blue (464), black (564) lacquered American walnut. Available front finishes: white, grey, air force blue, black bamboo lamination; natural, white, grey, air force blue, black lacquered American walnut.

Kommode aus Nussbaum, vier Schubladen, Füße aus gebürstetem Stahl oder weiß lackiert. Korpusausführungen: amerikanisches Nussbaum natur lasiert (64); Nussbaum weiß (264), grau (364), schieferblau (464), schwarz (564) lackiert. Frontausführungen: weißes, graues, schieferblaues oder schwarzes Bambusfurnier, amerikanisches Nussbaum natur lasiert; Nussbaum weiß, grau, schieferblau, schwarz lackiert.

Commode en noyer, quatre tiroirs, pieds en acier brossé ou bien laqués blanc. Finitions structure: noyer américain verni naturel (64), noyer laqué blanc (264), gris (364), bleu ardoise (464), noir (564). Finitions faces: placage de bambou blanc, gris, bleu ardoise, noir; noyer américain verni naturel, laqué blanc, gris, bleu ardoise, noir.

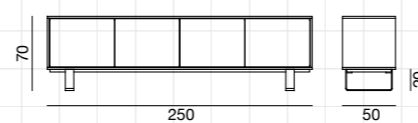

p. 39

Mobile contenitore in noce, quattro ante, piedini in acciaio spazzolato o laccato bianco, due ripiani interni regolabili. Finiture struttura: noce Canaletto verniciato naturale (69), laccato bianco (269), grigio (369), avio (469), nero (569). Finiture frontali: bambù pressato a doghe bianco, grigio, avio, nero; noce Canaletto verniciato naturale; laccato bianco, grigio, avio o nero.

Storage unit in walnut, four doors, brushed steel or white lacquered metal feet, two adjustable shelves. Available frame finishes: natural (69), white (269), grey (369), air force blue (469), black (569) lacquered American walnut. Available front finishes: white, grey, air force blue, black bamboo lamination; natural, white, grey, air force blue, black lacquered American walnut.

Sideboard aus Nussbaum, vier Türen, Füße aus gebürstetem Stahl oder weiß lackiert, zwei verstellbare Fachböden. Korpusausführungen: amerikanisches Nussbaum natur lasiert (69); Nussbaum weiß (269), grau (369), schieferblau (469), schwarz (569) lackiert. Frontausführungen: weißes, graues, schieferblaues oder schwarzes Bambusfurnier, amerikanisches Nussbaum natur lasiert; Nussbaum weiß, grau, schieferblau, schwarz lackiert.

Buffet en noyer, quatre portes, pieds en acier brossé ou bien laqués blanc, deux tablettes réglables. Finitions structure: noyer américain verni naturel (69), noyer laqué blanc (269), gris (369), bleu ardoise (469), noir (569). Finitions faces: placage de bambou blanc, gris, bleu ardoise, noir; noyer américain verni naturel, laqué blanc, gris, bleu ardoise, noir.

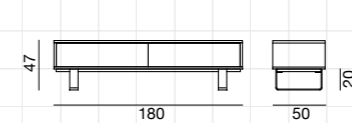

p. 82-83 / 97

Cassettiera in noce, due cassetti, piedini in acciaio spazzolato o laccato bianco. Finiture struttura: noce Canaletto verniciato naturale (83), laccato bianco (283), grigio (383), avio (483), nero (583). Finiture frontali cassetto: bambù pressato a doghe bianco, grigio, avio, nero; noce Canaletto verniciato naturale; laccato bianco, grigio, avio o nero.

Chest of drawers in walnut, two drawers, brushed steel or white lacquered metal feet. Available frame finishes: natural (83), white (283), grey (383), air force blue (483), black (583) lacquered American walnut. Available front finishes: white, grey, air force blue, black bamboo lamination; natural, white, grey, air force blue, black lacquered American walnut.

Kommode aus Nussbaum, zwei Schubladen, Füße aus gebürstetem Stahl oder weiß lackiert. Korpusausführungen: amerikanisches Nussbaum natur lasiert (83); Nussbaum weiß (283), grau (383), schieferblau (483), schwarz (583) lackiert. Frontausführungen: weißes, graues, schieferblaues oder schwarzes Bambusfurnier, amerikanisches Nussbaum natur lasiert; Nussbaum weiß, grau, schieferblau, schwarz lackiert.

Commode en noyer, deux tiroirs, pieds en acier brossé ou bien laqués blanc. Finitions structure: noyer américain verni naturel (83), noyer laqué blanc (283), gris (383), bleu ardoise (483), noir (583). Finitions faces: placage de bambou blanc, gris, bleu ardoise, noir; noyer américain verni naturel, laqué blanc, gris, bleu ardoise, noir.

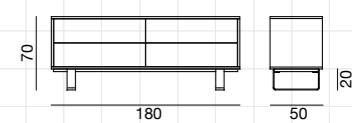

p. 99

Cassettiera in noce, quattro cassetti, piedini in acciaio spazzolato o laccato bianco. Finiture struttura: noce Canaletto verniciato naturale (84), laccato bianco (284), grigio (384), avio (484), nero (584). Finiture frontali cassetto: bambù pressato a doghe bianco, grigio, avio, nero; noce Canaletto verniciato naturale; laccato bianco, grigio, avio o nero.

Chest of drawers in walnut, four drawers, brushed steel or white lacquered metal feet. Available frame finishes: natural (84), white (284), grey (384), air force blue (484), black (584) lacquered American walnut. Available front finishes: white, grey, air force blue, black bamboo lamination; natural, white, grey, air force blue, black lacquered American walnut.

Kommode aus Nussbaum, vier Schubladen, Füße aus gebürstetem Stahl oder weiß lackiert. Korpusausführungen: amerikanisches Nussbaum natur lasiert (84); Nussbaum weiß (284), grau (384), schieferblau (484), schwarz (584) lackiert. Frontausführungen: weißes, graues, schieferblaues oder schwarzes Bambusfurnier, amerikanisches Nussbaum natur lasiert; Nussbaum weiß, grau, schieferblau, schwarz lackiert.

Commode en noyer, quatre tiroirs, pieds en acier brossé ou bien laqués blanc. Finitions structure: noyer américain verni naturel (84), noyer laqué blanc (284), gris (384), bleu ardoise (484), noir (584). Finitions faces: placage de bambou blanc, gris, bleu ardoise, noir; noyer américain verni naturel, laqué blanc, gris, bleu ardoise, noir.

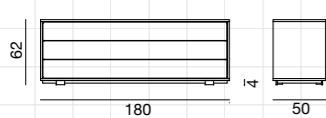

p. 64

Cassettiera in noce, tre cassetti, piedini in acciaio spazzolato o laccato bianco. Finiture struttura: noce Canaletto verniciato naturale (65), laccato bianco (265), grigio (365), avio (465), nero (565). Finiture frontali cassetto: bambù pressato a doghe bianco, grigio, avio, nero; noce Canaletto verniciato naturale; laccato bianco, grigio, avio o nero.

Chest of drawers in walnut, three drawers, brushed steel or white lacquered metal feet. Available frame finishes: natural (65), white (265), grey (365), air force blue (465), black (565) lacquered American walnut. Available front finishes: white, grey, air force blue, black bamboo lamination; natural, white, grey, air force blue, black lacquered American walnut.

Kommode aus Nussbaum, drei Schubladen, Füße aus gebürstetem Stahl oder weiß lackiert. Korpusausführungen: amerikanisches Nussbaum natur lasiert (65); Nussbaum weiß (265), grau (365), schieferblau (465), schwarz (565) lackiert. Frontausführungen: weißes, graues, schieferblaues oder schwarzes Bambusfurnier, amerikanisches Nussbaum natur lasiert; Nussbaum weiß, grau, schieferblau, schwarz lackiert.

Commode en noyer, trois tiroirs, pieds en acier brossé ou bien laqués blanc. Finitions structure: noyer américain verni naturel (65), noyer laqué blanc (265), gris (365), bleu ardoise (465), noir (565). Finitions faces: placage de bambou blanc, gris, bleu ardoise, noir; noyer américain verni naturel, laqué blanc, gris, bleu ardoise, noir.

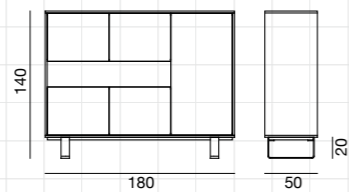

p. 56-57

Mobile contenitore in noce, cinque ante, piedini in acciaio spazzolato o laccato bianco, quattro ripiani interni regolabili. Finiture struttura: noce Canaletto verniciato naturale (67), laccato bianco (267), grigio (367), avio (467), nero (567). Finiture frontali cassetto: bambù pressato a doghe bianco, grigio, avio, nero; noce Canaletto verniciato naturale; noce laccato bianco, grigio, avio o nero.

Storage unit in walnut, five doors, brushed steel or white lacquered metal feet, four adjustable shelves. Available frame finishes: natural (67), white (267), grey (367), air force blue (467), black (567) lacquered American walnut. Available front finishes: white, grey, air force blue, black bamboo lamination; natural, white, grey, air force blue, black lacquered American walnut.

Sideboard aus Nussbaum, fünf Türen, Füße aus gebürstetem Stahl oder weiß lackiert, vier verstellbare Fachböden. Korpusausführungen: amerikanisches Nussbaum natur lasiert (67); Nussbaum weiß (267), grau (367), schieferblau (467), schwarz (567) lackiert. Frontausführungen: weißes, graues, schieferblaues oder schwarzes Bambusfurnier, amerikanisches Nussbaum natur lasiert; Nussbaum weiß, grau, schieferblau, schwarz lackiert.

Bahut en noyer, cinq portes, pieds en acier brossé ou bien laqués blanc, quatre tablettes réglables. Finitions structure: noyer américain verni naturel (67), noyer laqué blanc (267), gris (367), bleu ardoise (467), noir (567). Finitions faces: placage de bambou blanc, gris, bleu ardoise, noir; noyer américain verni naturel, laqué blanc, gris, bleu ardoise, noir.



p. 56-57

Mobile contenitore in noce, cinque ante, piedini in acciaio spazzolato o laccato bianco, quattro ripiani interni regolabili. Finiture struttura: noce Canaletto verniciato naturale (67), laccato bianco (267), grigio (367), avio (467), nero (567). Finiture frontali cassetto: bambù pressato a doghe bianco, grigio, avio, nero; noce Canaletto verniciato naturale; noce laccato bianco, grigio, avio o nero.

Storage unit in walnut, five doors, brushed steel or white lacquered metal feet, four adjustable shelves. Available frame finishes: natural (67), white (267), grey (367), air force blue (467), black (567) lacquered American walnut. Available front finishes: white, grey, air force blue, black bamboo lamination; natural, white, grey, air force blue, black lacquered American walnut.

Sideboard aus Nussbaum, fünf Türen, Füße aus gebürstetem Stahl oder weiß lackiert, vier verstellbare Fachböden. Korpusausführungen: amerikanisches Nussbaum natur lasiert (67); Nussbaum weiß (267), grau (367), schieferblau (467), schwarz (567) lackiert. Frontausführungen: weißes, graues, schieferblaues oder schwarzes Bambusfurnier, amerikanisches Nussbaum natur lasiert; Nussbaum weiß, grau, schieferblau, schwarz lackiert.

Bahut en noyer, cinq portes, pieds en acier brossé ou bien laqués blanc, quatre tablettes réglables. Finitions structure: noyer américain verni naturel (67), noyer laqué blanc (267), gris (367), bleu ardoise (467), noir (567). Finitions faces: placage de bambou blanc, gris, bleu ardoise, noir; noyer américain verni naturel, laqué blanc, gris, bleu ardoise, noir.

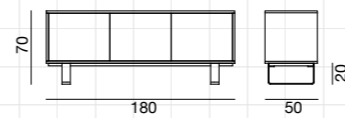

p. 2

Mobile contenitore in noce, tre ante, piedini in acciaio spazzolato o laccato bianco, due ripiani interni regolabili. Finiture struttura: noce Canaletto verniciato naturale (85), laccato bianco (285), grigio (385), avio (485), nero (585). Finiture frontali cassetto: bambù pressato a doghe bianco, grigio, avio, nero; noce Canaletto verniciato naturale; laccato bianco, grigio, avio o nero.

Storage unit in walnut, three doors, brushed steel or white lacquered metal feet, two adjustable shelves. Available frame finishes: natural (85), white (285), grey (385), air force blue (485), black (585) lacquered American walnut. Available front finishes: white, grey, air force blue, black bamboo lamination; natural, white, grey, air force blue, black lacquered American walnut.

Sideboard aus Nussbaum, drei Türen, Füße aus gebürstetem Stahl oder weiß lackiert, zwei verstellbare Fachböden. Korpusausführungen: amerikanisches Nussbaum natur lasiert (85); Nussbaum weiß (285), grau (385), schieferblau (485), schwarz (585) lackiert. Frontausführungen: weißes, graues, schieferblaues oder schwarzes Bambusfurnier, amerikanisches Nussbaum natur lasiert; Nussbaum weiß, grau, schieferblau, schwarz lackiert.

Buffet en noyer, trois portes, pieds en acier brossé ou bien laqués blanc, deux tablettes réglables. Finitions structure: noyer américain verni naturel (85), noyer laqué blanc (285), gris (385), bleu ardoise (485), noir (585). Finitions faces: placage de bambou blanc, gris, bleu ardoise, noir; noyer américain verni naturel, laqué blanc, gris, bleu ardoise, noir.

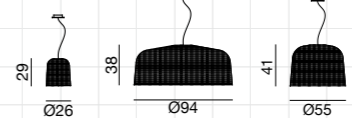

p. 82-83 / 97

Lampada a sospensione intrecciata in PVC nero opaco o bianco lucido, 14W (Sweet 91) o 18 W (Sweet 95/96), 220 Volt.

Suspension lamp woven with matt black or glossy white PVC, 14W (Sweet 91) or 18 W (Sweet 95/96), 220 Volt.

Deckenleuchte aus matt schwarzem oder glänzend weißem PVC, handgeflochten, 14W (Sweet 91) oder 18 W (Sweet 95/96), 220 Volt.

Suspension tressée en PVC noir mat ou bien blanc brillant, 14W (Sweet 91) ou 18 W (Sweet 95/96), 220 Volt.



p. 39 / 64 / 102

Specchio con decoro verniciato bianco o nero. Mirror with white or black lacquered decoration. Spiegel mit weiß oder schwarz lackiertem Muster. Miroir avec décoration laquée blanche ou noire.

# credits:

creative direction **PAOLA NAVONE**  
product design **OTTO / DOMENICO DIEGO, MARCO OLGATI**  
photo **STUDIO PIERO GEMELLI / MILANO**  
concept & styling **BEATRICE ROSSETTI**  
with **WILSON POLEGATO**  
collaboration **VERONICA LEALI**  
style coordination **OTTO / CRISTINA PETTENUZZO**  
graphic **GENNY CANTON STUDIO**  
separations **LUCE SRL**  
printed by **SINCROMIA**, SEPT 2016

# thanks to:

ALESSANDRA MEACCI [WWW.ALEMEACCI-DESIGN.COM](http://WWW.ALEMEACCI-DESIGN.COM)

18/30/31

ALESSI [WWW.ALESSI.COM](http://WWW.ALESSI.COM)

49/60-61/81/82-83/87/89

ALIDEM [WWW.ALIDEM.COM](http://WWW.ALIDEM.COM)

2/30/31/86/89

ANTONANGELI ILLUMINAZIONE [WWW.ANTONANGELI.IT](http://WWW.ANTONANGELI.IT)

16/50-51/71/72

ARNOLFO DI CAMBIO [WWW.ARNOLFODICAMBIO.COM](http://WWW.ARNOLFODICAMBIO.COM)

71/76

BOSA [WWW.BOSATRADE.COM](http://WWW.BOSATRADE.COM)

5/50/64/84-85/98/102/103

BOTTEGA NOVE [WWW.BOTTEGANOVE.IT](http://WWW.BOTTEGANOVE.IT)

91

CC TAPIS/ [WWW.CC-TAPIS.COM](http://WWW.CC-TAPIS.COM)

2/14-15/18/ 24-25/ 30/31/38/40/72-73/74/78-79/80/84-85/

86-87/102

COLE' ITALIAN DESIGN LABEL - [WWW.COLEITALIA.COM](http://WWW.COLEITALIA.COM)

24/27

CONTARDI LIGHTING [WWW.CONTARDI/ITALIA.COM](http://WWW.CONTARDI/ITALIA.COM)

102-103

EDB DESIGN [WWW.ELEONORADB.IT](http://WWW.ELEONORADB.IT)

26

EDITAMATERIA [WWW.EDITAMATERIA.COM](http://WWW.EDITAMATERIA.COM)

52-53/68/97

ELIGO [WWW.ELIGO.IT](http://WWW.ELIGO.IT)

10/12-13/14-15/62

FATTO AD ARTE [WWW.FATTOADARTE.COM](http://WWW.FATTOADARTE.COM)

41/65/97/102

FONTANA ARTE [WWW.FONTANAARTE.COM](http://WWW.FONTANAARTE.COM)

46/100

FRANCO MAZZUCHELLI [WWW.FRANCOMAZZUCHELLI.IT](http://WWW.FRANCOMAZZUCHELLI.IT)

67

GHIDINI 1961 [WWW.GHIDINI1961.COM](http://WWW.GHIDINI1961.COM)

29/34/37/38/43

KASTHALL [WWW.KASTHALL.COM](http://WWW.KASTHALL.COM)

20-21/24-25/26/27/32/34-35/36/37/49/50-51/58/64-65/66-67/69

ICHENDORF-CORRADO CORRADI

[WWW.ICHENDORFMILANO.COM](http://WWW.ICHENDORFMILANO.COM)

22/29/30/31/32/34/37/41/43/46

IITTALA [WWW.IITTALA.COM](http://WWW.IITTALA.COM)

52-53/104-105

INCIPIT [WWW.INCIPITLAB.COM](http://WWW.INCIPITLAB.COM) 2

21/31/32/34/37/38/41/42/70/71/104

KIASMO [WWW.KIASMO.IT](http://WWW.KIASMO.IT)

24/73

LANEROSI DIVISION OF MARZOTTO LAB

[WWW.MARZOTTOHOME.COM](http://WWW.MARZOTTOHOME.COM)

48/50

LINCK KERAMIK DA COLÈ GALLERY [WWW.LINCK.CH](http://WWW.LINCK.CH)

2/83

LOLOEY [WWW.LOLOEY.COM](http://WWW.LOLOEY.COM)

4-5/6-7/8/34-35/ 44-45/68/71/78/98-99

LUCEPLAN [WWW.LUCEPLAN.COM](http://WWW.LUCEPLAN.COM)

30/31/34-35/91

MARCO RIPA [WWW.MARCORIPA.IT](http://WWW.MARCORIPA.IT)

4/8/64/92

MODOLUCE [WWW.MODOLUCE.COM](http://WWW.MODOLUCE.COM)

21/24/27/68/78-79

NAHOOR / [WWW.NAHOOR.COM](http://WWW.NAHOOR.COM)

84/98

NORMANN COPENHAGEN [WWW.NORMANN/COPENHAGEN.COM](http://WWW.NORMANN/COPENHAGEN.COM)

30/46/57/90/104/106-107

OPEN DESIGN ITALIA FACTORY [WWW.ODIFACTORY.COM](http://WWW.ODIFACTORY.COM)

48/58-59

OTTICA URBANI [WWW.OTTICAURBANI.COM](http://WWW.OTTICAURBANI.COM)

67/69

PANDUL [WWW.PANDUL.DK](http://WWW.PANDUL.DK)

58-59/64-65

PAOLA PARONETTO [WWW.PAOLA/PARONETTO.COM](http://WWW.PAOLA/PARONETTO.COM)

5/8/24/26-27/50/60-61/102

PENTA LIGHT [WWW.PENTALIGHT.IT](http://WWW.PENTALIGHT.IT)

56/59/73/75

REGGIANI CERAMICA [WWW.REGGIANICERAMICA.COM](http://WWW.REGGIANICERAMICA.COM)

22/23/29/30/31/60/105

RINA MENARDI [WWW.RINAMENARDI.COM](http://WWW.RINAMENARDI.COM)

18/24/26-27/38-39/50/52-53/57/60/63/68/93/95

SARA KIRSCHEN [WWW.SARAKIRSCHEN.IT](http://WWW.SARAKIRSCHEN.IT)

41/47/102

SIMONA CARDINETTI [WWW.SIMONACARDINETTI.COM](http://WWW.SIMONACARDINETTI.COM) /

PAU DESIGN CONTAINER [WWW.PAUDESIGNCONTAINER.COM](http://WWW.PAUDESIGNCONTAINER.COM)

22/57/91

SOCIETY LIMONTA [WWW.SOCIETYLIMONTA.COM](http://WWW.SOCIETYLIMONTA.COM)

41/46-47/52-53/63/66-67/68/81/86-87/104-105

SOMETHINGGOOD [WWW.SOMETHINGGOOD.IT](http://WWW.SOMETHINGGOOD.IT)

5/71/93/98-99

STEFANO PUGLIESE [WWW.STEFANOPUGLIESE.COM](http://WWW.STEFANOPUGLIESE.COM) /

CREA CEMENTO [WWW.CREACEMENTO.COM](http://WWW.CREACEMENTO.COM)

92

STONECYCLE [WWW.STONECYCLE.IT](http://WWW.STONECYCLE.IT)

19/28/29/59

VANOALTO [VANOALTO.TUMBLR.COM](http://VANOALTO.TUMBLR.COM)

52-53/91/107

ZANETTO [WWW.ZANETTO.COM](http://WWW.ZANETTO.COM)

70/79/92/94

ZAVA [WWW.ZAVALUCE.IT](http://WWW.ZAVALUCE.IT)

5/47/49

ZPSTUDIO TOOLS DA COLÈ GALLERY

[WWW.ZPSTUDIOTOOLS.IT](http://WWW.ZPSTUDIOTOOLS.IT)

2/21/45/107

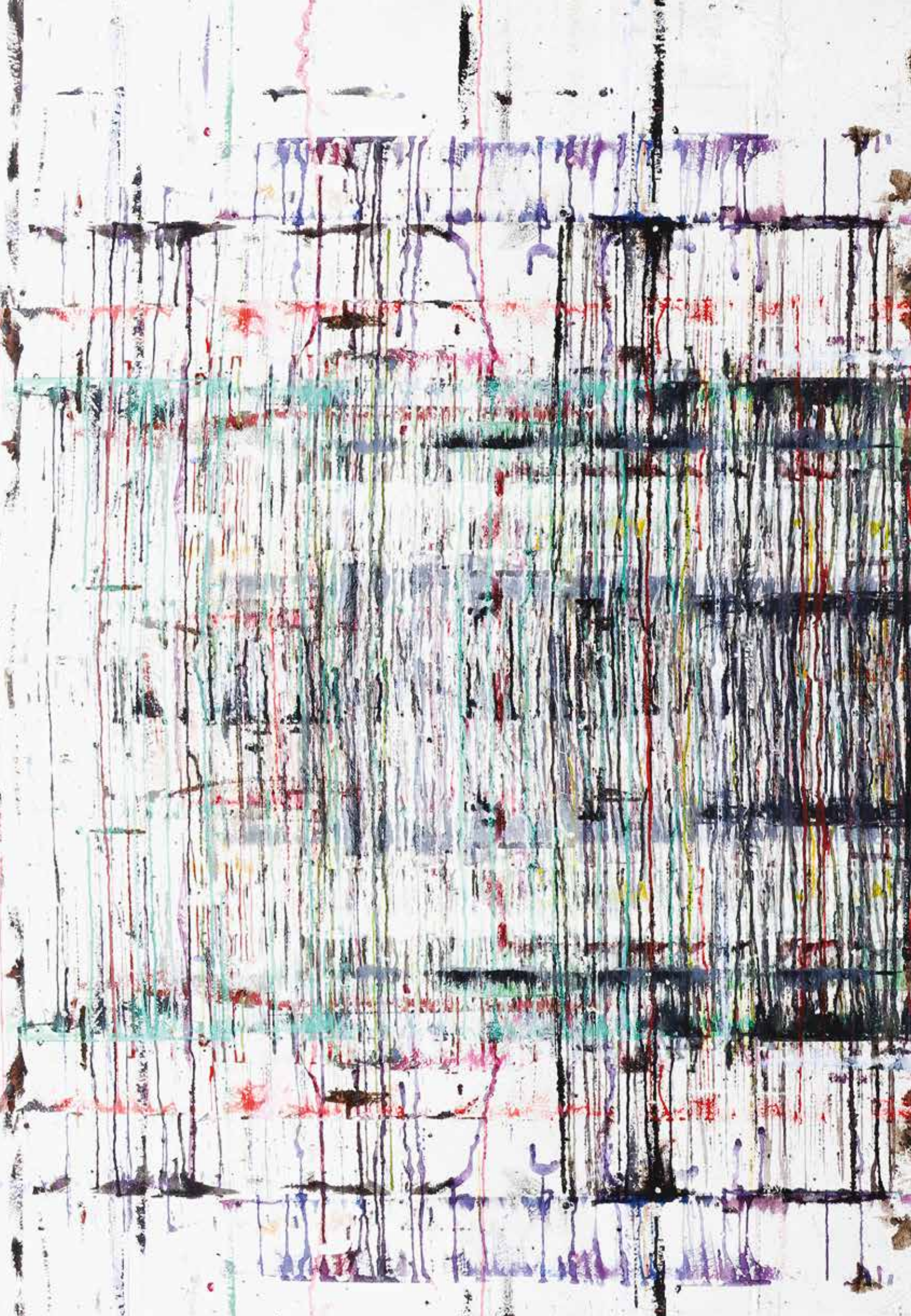

# GERVASONI™

Gervasoni spa.  
Viale del Lavoro, 88  
33050 Pavia di Udine, Italia  
ph +39 0432 656611  
fax +39 0432 656612  
info@gervasoni1882.com  
www.gervasoni1882.com



ITALIAN DESIGN BRANDS®

Gervasoni fa parte del gruppo  
Italian Design Brands  
Gervasoni is part of  
Italian Design Brands Group

Gervasoni spa è dotata di un Sistema di Certificazione di Qualità UNI EN ISO 9001:2008, di Gestione Ambientale UNI EN ISO 14001:2004 e di un Sistema di Certificazione per la gestione della Sicurezza e della Salute dei lavoratori OHSAS 18001:2012.

Gervasoni spa is certified to UNI EN ISO 9001:2008 Company Quality System Certification, ISO 14001:2004 Environmental Certification and OHSAS 18001:2012 Certification for Health and Safety Management Systems.



CATGRAY16