

CATALOG 2021



EDEN GARDEN

PATIO UMBRELLAS





EDEN GARDEN

Our many years of experience and our dedication in creating umbrellas pushes us to always seek the most durable materials, the best fabrics, the most refined finishes.

This continuous research has led us to take materials from all over the world and to constantly check their quality. No less than perfect material is used in the production of our parasols.

Each step, from the conception to the creation of our products, is followed by our staff with the utmost attention to the needs of our customers: every single detail is analyzed to offer you the best possible solution to let You enjoy your outdoor space.





Quality.
Passion.
Durability.
Innovation.
Customization.

OUR MAIN VALUES

QUALITY

Our strongest value and main priority. The perfect blend of skilled craftsmen and first choice raw materials lead to the creation of a product of the highest quality. Every step of the product development is meticulously checked, as well as every step of its production.



PASSION

For over thirty years, passion has guided us in the design and development of our umbrellas. Combine passion with experience and you will get our products as a result: study, time, preparation, attention, effort, you will find all this and much more in our umbrellas.





DURABILITY

In the choice of our materials and their processing we leave nothing to chance: the solidity and versatility of the iroko wood, the reliability of the reinforced concrete bases, the strength of the reinforced and oven-painted steel, the longevity of the stainless steel and the undisputed quality of our fabrics allow us to guarantee each component of our umbrellas for two years.

All our umbrellas have a reinforced concrete base that can also be made as underground installation plates, wall-mounted brackets or other customized solutions.



INNOVATION

We have made innovation a top priority in our work. We use the most advanced machinery and the best design softwares in the development of our umbrellas, but what makes them truly unique is the craftsmanship behind each of them, carried out by our team every day with passion and determination.

CUSTOMIZATION

One of our greatest reasons for pride is to give our customers the opportunity to choose exactly what they need. Whether their needs are dictated by space or simply aesthetic tastes, we are ready to fulfill any desire. Every single component of our umbrellas is customizable, from size to shape, through materials and colors, there is nothing that cannot be changed to meet every need: our team of experts is always ready to find with you the best possible solution.





FEATURES



Waterproof cover



Easy rib change



Raised wind valve



Double pulley



Base included



Split solution



Telescopic



Velcro



Ground anchor



Raingutter



Wall anchor



180° Rotation



360° Rotation



Strong wind resistance



High Winch (Anti-vandalic)



Low Winch



A FEW STEPS TO CHOOSE THE **RIGHT** UMBRELLA

Think about your outdoor space. Do you want to cover it all or only partially?

Take into account the area you are in: is there a lot of sun? Does it rain quite often? Is it very windy?

Which style of furniture do you prefer: classic or modern?



Consider the space you want your umbrella to cover: is there enough space for the base or is it better to anchor it?

Look around you and think about the effect you want to achieve: do you want your umbrella to blend in with the surrounding environment or do you prefer to create some contrast?

Take into consideration all the elements that you find important and contact us: we are at your complete disposal to provide you with advice and technical indications to make your outdoor space unique.



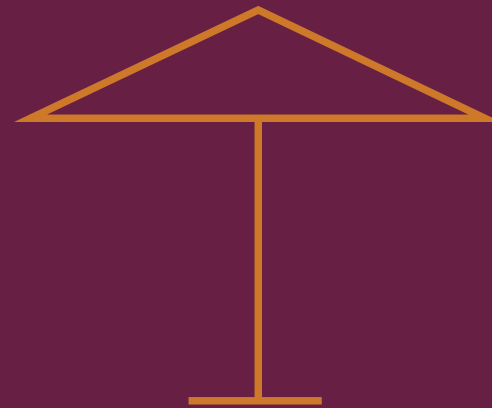

CENTRAL POST UMBRELLAS



**WHY
FIESOLE ?**
Classic model
Durable
Convenient

FIESOLE

Fiesole is a real classic, and like any classic it fits perfectly into any environment.

Whether it is outside an elegant city restaurant or in the garden of a beach house, the result will always be impeccable: its timeless elegance, combined with the infinite possibilities of customization, make it the ideal choice for any outdoor space.



STANDARD FEATURES



OPTIONAL FEATURES



CANOPY SHAPES & SIZES

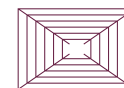

[cm]
200 x 300
250 x 350
300 x 400

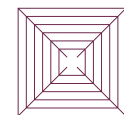

[cm]
300 x 300
350 x 350
400 x 400
500 x 500



[cm]
Ø 300
Ø 350
Ø 400



**WHY
BIG FRIEND ?**
Imposing
Reliable
Telescopic closing
system

BIG FRIEND

Imposing. The first adjective that comes to mind when looking at Big Friend. Big Friend combines the classic central pole umbrella with a natural predisposition to cover huge spaces: twelve reinforced aluminum ribs around a telescopic steel pole make it the ideal solution to cover large spaces in an elegant and functional way.



STANDARD FEATURES



OPTIONAL FEATURES



CANOPY SHAPES & SIZES

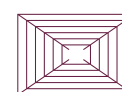

[cm]
450x550
500x600
550x650
600x700

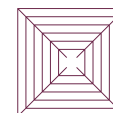

[cm]
500x500
550x550
600x600
650x650
700x700



[cm]
Ø 550
Ø 600
Ø 650
Ø 700
Ø 750
Ø 800



**WHY
KITE ?**

Futuristic
100% waterproof
Strong

KITE

Kite is the umbrella of the future.

The sturdy structure in galvanized iron, the electric opening mechanism, the specific curved shape of the canopy, made of pretensioned PVC: all these, and many other features make Kite the ideal choice for places heavily exposed to the wind or subject to frequent climate changes.

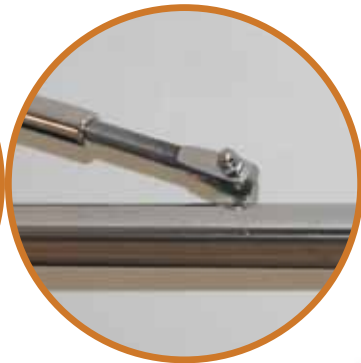

STANDARD FEATURES



OPTIONAL FEATURES



CANOPY SHAPES & SIZES

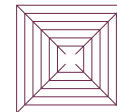

[cm]
300 x 300
350 x 350
400 x 400
450 x 450
500 x 500
550 x 550
600 x 600



**WHY
CIAK ?**

- Smallest lateral footprint
- Fits perfectly in narrow streets
- Easy to operate

CIAK

The inspiration for Ciak was given to us by the narrow streets of the ancient centers of many European cities.

Ciak is able to exploit the outdoor space in the best possible way: the side pole creates the minimum bulk and the wide range of possible sizes make it perfect for covering spaces that extend in width and not in depth.



STANDARD FEATURES



OPTIONAL FEATURES



CANOPY SHAPES & SIZES



[cm]
100 x 250
125 x 250
125 x 350
150 x 300
150 x 325
150 x 400
175 x 250
175 x 350
175 x 450
200 x 300
200 x 400
200 x 500
225 x 350
250 x 400
250 x 500



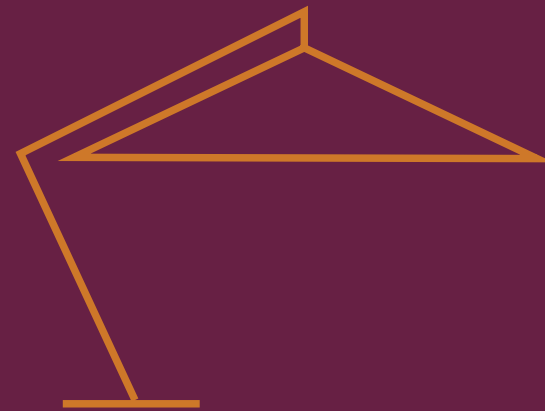

SIDE POST UMBRELLAS



**WHY
ARCO ?**

Elegant
Arch shaped
carrier beam
Timeless

ARCO

Arco's appearance is iconic. With the curvature of the iroko wood, which gives the pole its characteristic arch-shaped appearance, there is no exterior that cannot be redefined and embellished by Arco.



STANDARD FEATURES



OPTIONAL FEATURES



CANOPY SHAPES & SIZES

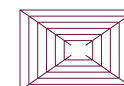

[cm]
200 x 300
250 x 350
300 x 400

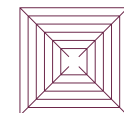

[cm]
300 x 300
350 x 350



[cm]
Ø 300
Ø 350
Ø 400



**WHY
TALENTO?**

Versatile
Medium sized
360° rotation

TALENTO

When designing Talento, we had one purpose in mind: a versatile umbrella.

Its medium size, combined with the side pole that leaves the space underneath the canopy completely free, and the possibility to rotate by 360°, make Talento a perfect choice for both private and professional use.



STANDARD FEATURES



OPTIONAL FEATURES



CANOPY SHAPES & SIZES

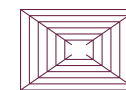

[cm]
200 x 300
250 x 350
300 x 400
350 x 450

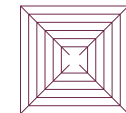

[cm]
250 x 250
300 x 300
325 x 325
350 x 350
400 x 400



[cm]
Ø 300
Ø 350
Ø 400
Ø 450



**WHY
TALENTO STEEL ?**

Minimalistic
Stainless steel
construction
Minimal footprint

TALENTO STEEL

The constant research to optimize space has led us to create Talento Steel, an umbrella with simple and essential lines that creates the minimum footprint and that can be made with wall anchors customized to your needs. We offer a classic version, with stainless steel pole and aluminum ribs or a mirror polished stainless steel version, particularly suitable for installation on yachts or modern style buildings.



STANDARD FEATURES



OPTIONAL FEATURES



CANOPY SHAPES & SIZES

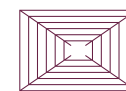

[cm]
200 x 300
250 x 350
300 x 400
350 x 450

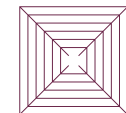

[cm]
250 x 250
300 x 300
325 x 325
350 x 350
400 x 400



[cm]
Ø 300
Ø 350
Ø 400
Ø 450



**WHY
MISTER ?**
Monumental
Strong
Elegant

MISTER

Monumental. Mister is a gentle and friendly giant who, thanks to his 14x14 side pole, can hold canopies covering a space of up to 25m². It can be made with a 360° rotating base, to allow you to enjoy its shade throughout the day.



STANDARD FEATURES



OPTIONAL FEATURES



CANOPY SHAPES & SIZES

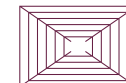

[cm]
500 x 400
550 x 450

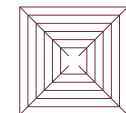

[cm]
400 x 400
500 x 500



[cm]
Ø 500
Ø 600





MULTIPLE CANOPY UMBRELLAS

**WHY
GEMELLI
LATERALE ?**

Double canopy on one pole
Size up to 5x10m
Perfect for rectangular
spaces





GEMELLI LATERALE

Two canopies supported by a side pole and joined by fabric rain gutters, will allow you to cover rectangular spaces up to 5x10m and to fully enjoy the space below.
The elegant line and the best quality materials make Gemelli Laterale a real classic.



STANDARD FEATURES



OPTIONAL FEATURES



CANOPY SHAPES & SIZES

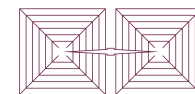

- [cm]
- 250 x 500
- 300 x 600
- 325 x 650
- 350 x 700
- 400 x 800
- 450 x 900
- 500 x 1000

The image shows an outdoor dining area with several large, double-canopy umbrellas. The umbrellas have a wooden frame and a light-colored fabric top. They are supported by a single central pole. The area is furnished with dark wicker chairs and tables. In the background, there is a large glass window reflecting the surrounding greenery and a brick wall. The scene is brightly lit, suggesting a sunny day.

**WHY
GEMELLI
CENTRALE ?**

Double canopy on one pole

Size up to 5x10m

Perfect for rectangular
spaces

GEMELLI CENTRALE

Two canopies this time supported by a central pole. It is the ideal solution if you want to cover large spaces, leaving the side passages free. The central base can be used to create additional seating or as a table.



STANDARD FEATURES



OPTIONAL FEATURES



CANOPY SHAPES & SIZES

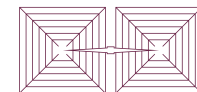

- [cm]
250 x 500
300 x 600
325 x 650
350 x 700
400 x 800
450 x 900
500 x 1000

**WHY
GEMELLI
STEEL ?**

Double canopy with
rotation feature
Wall anchor on request
Raingutter included



GEMELLI STEEL

We can consider Gemelli Steel as an evolution of Gemelli. The central pole can be square or round and the two canopies can be rotated 180° to guarantee you the possibility to enjoy the shade all day long. Optional wall anchor makes it suitable for any environment, especially yachts and terraces.



STANDARD FEATURES



OPTIONAL FEATURES



CANOPY SHAPES & SIZES

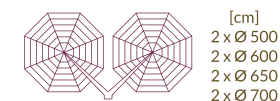
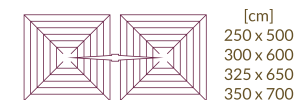



**WHY
COLLAGE ?**

Massive
Four canopies on one pole
Completely customizable

COLLAGE

Four canopies supported by a single pole can cover up to 100m². The colossal dimensions of Collage are combined with a minimal and elegant design and extremely refined finishes. There is no better choice to cover large spaces!



STANDARD FEATURES



OPTIONAL FEATURES



CANOPY SHAPES & SIZES

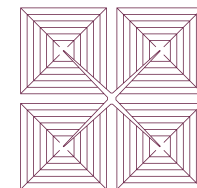

[cm]
500 x 500
600 x 600
650 x 650
700 x 700
800 x 800
900 x 900
1000 x 1000





FABRIC & COLORS

The fabric is the most exposed part of the umbrella. Ensuring fabric's durability and vividness of color is vital in order to keep the umbrellas enticing through the test of time.

GREEN® FABRIC

A worldwide innovation! The first fabric to purify the air by means of photocatalysis. GREEN fabric eliminates pollutants as NO_x, SO_x and VOCs.

GREEN is a fabric coated with titanium-dioxide (TiO₂) nanoparticles.

When UVA rays hit GREEN fabrics, a chemical process begins that converts oxygen and water vapor from atmosphere into OH and O₂ cleaning agents.

OH converts organic dirt and volatile organic compounds into minerals and gas and returns to H₂O.



POLLUTION CONTROL



SELF CLEANING



REDUCES ODORS



AIR QUALITY



SUSTAINABILITY



COST SAVING

ACRYLIC

Teflon-treated acrylic is non-decomposable fabric with superior resistance to water and dirt.

100%-solution dyed acrylic fibres are fibres made through a complex process of impregnation that infiltrates the core of the fibre, thus ensuring bright and glowing colors. The coloured pigments impregnate the polymer solution before the fibers are formed.

This ensures high resistance to wear, excellent colour fastness, optimum resistance and exceptional behaviour in outdoor conditions and in the presence of microorganisms.



10
year limited
warranty

PVC PRECONTRACT

Soltis Proof 502 - 100% waterproof, pre-tensioned for high dimensional stability, UV resistant, fireproof (2nd class), easy to maintain, durable.

Precontract technology, protected by a worldwide patent, enables the production of flexible composite materials with exceptional dimensional properties, way above the industry's usual standards.

Precontract technology consists in applying a coating under bi-axial tension (along both the warp and the weft) throughout the manufacturing cycle: the flexible frame made from high tenacity PET micro-cables is coated with several layers of polymers, followed by a dirt resistant surface treatment.



MICRO-AIRED FABRIC

Soltis Horizon 86 & Soltis Perform 92 - state-of-the-art fabrics made out of recyclable materials, designed to provide weather and light protection with breathability

Soltis Horizon 86

Soltis Horizon 86 is a polyester fabric with PVC coating produced with patented Precontract Ferrari technology. It offers an excellent trade-off between solar heat and screen protection. Perfect visibility to the outside, as well as maintained high resistance to UV radiation and unfavorable weather conditions.

Soltis Perform 92

Soltis Perform 92 allows perfect visual and thermal comfort. With 4% openness, fantastic dimensional stability, light weight and being 100% recyclable, Soltis 92 Perform is an outstanding choice for canopy textile.

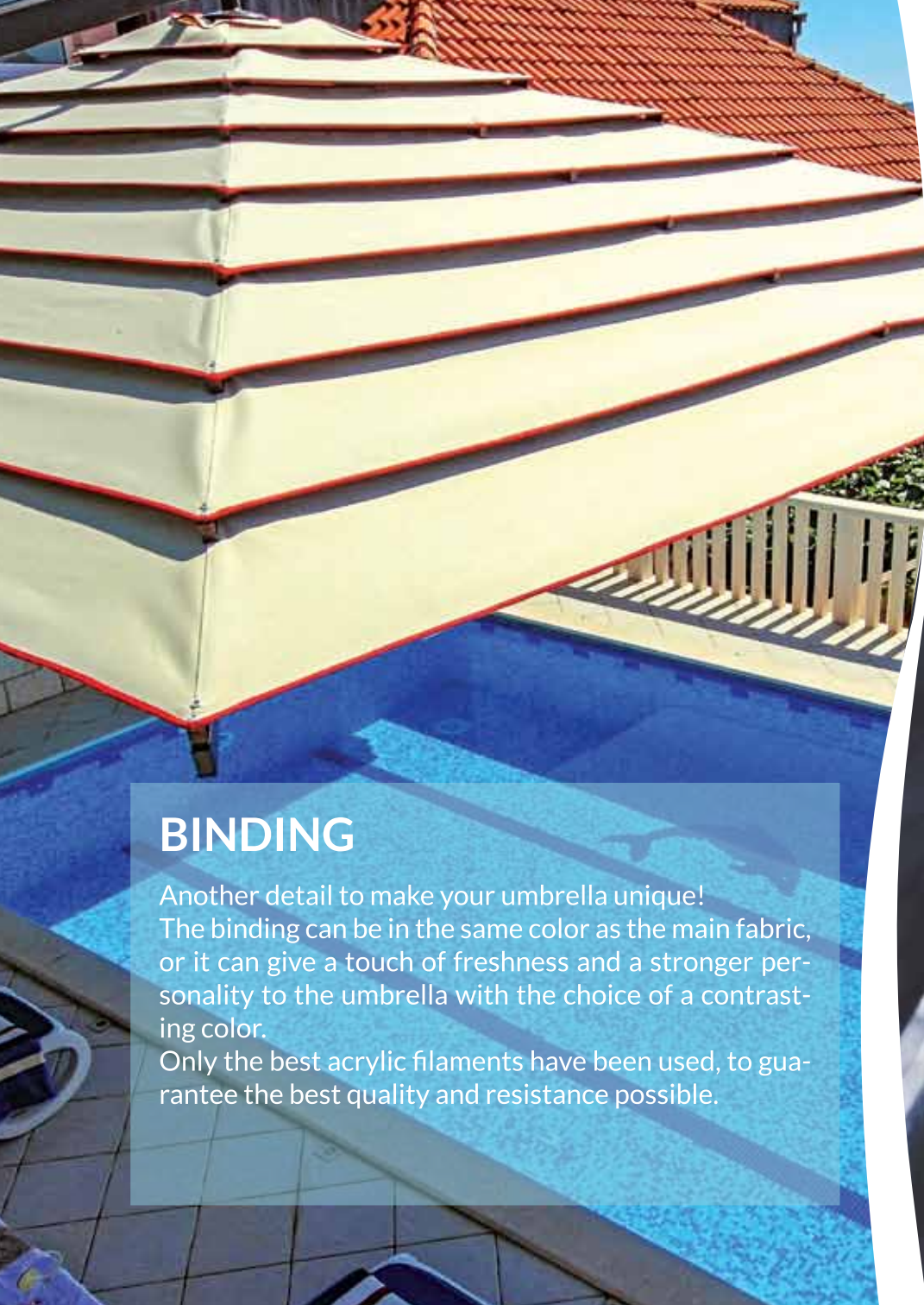

BINDING

Another detail to make your umbrella unique! The binding can be in the same color as the main fabric, or it can give a touch of freshness and a stronger personality to the umbrella with the choice of a contrasting color. Only the best acrylic filaments have been used, to guarantee the best quality and resistance possible.



FINISHING

EdenGarden's aluminum frames are powdercoated or eloxated on request. For all umbrellas up to size of 4x4 m with a raised valve, the ribs can be made out of Iroko wood or aluminum. Larger umbrellas and umbrellas with patented Split Solution system can be made only with aluminium ribs. All other metal components are zinc-plated and powder-coated (except for aluminum ribs and mirror polished stainless steel umbrellas).

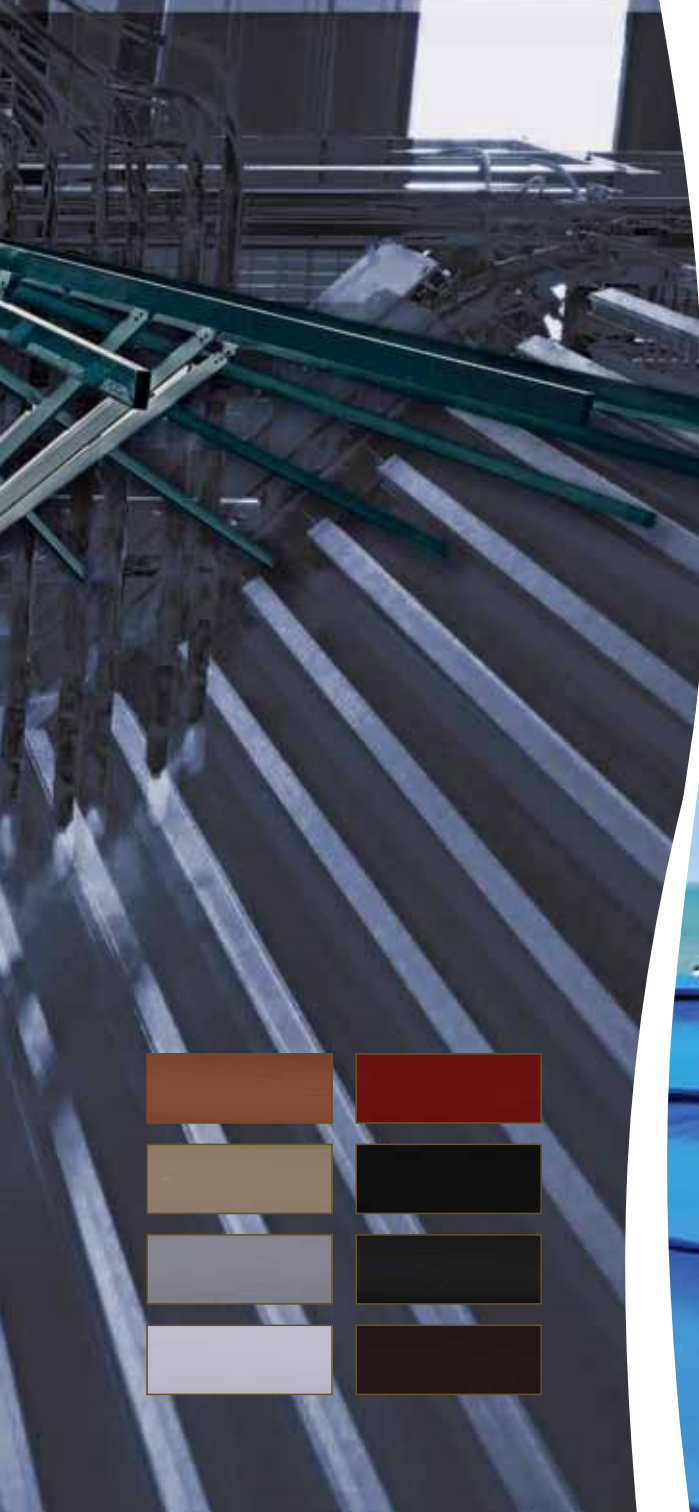

SPLIT SOLUTION

The SPLIT® SOLUTION is a patented anti-wind system with six overlapping fabric strips that help put an end to the “sail effect” caused by wind blowing against the canopy. The air passes through the layers without making any damage to the umbrella.

Standard umbrella canopy leaves the hot air trapped under the umbrella, the SPLIT® SOLUTION allows hot air to escape and enhances the chill sensation, making your staying under your umbrella way more pleasant even during the hottest days.



EXTRAS

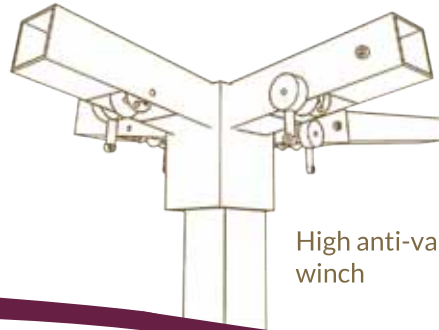

High anti-vandalic winch

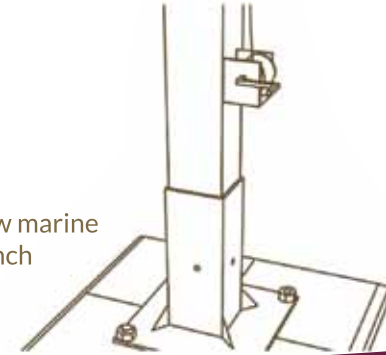

Low marine winch

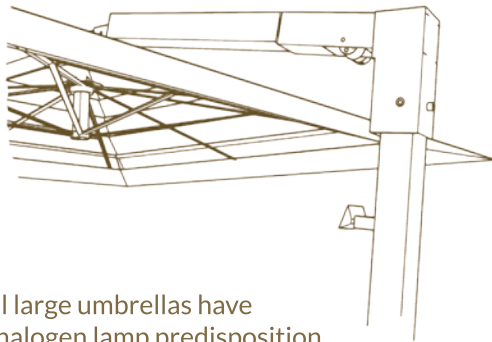

All large umbrellas have a halogen lamp predisposition.

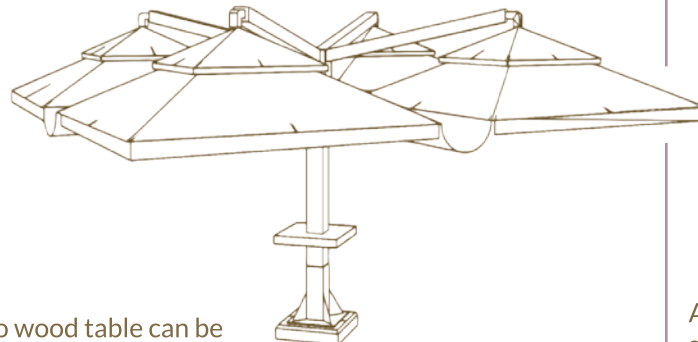

Iroko wood table can be available for side post umbrellas.

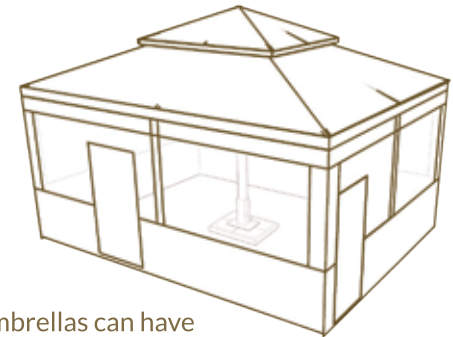

All umbrellas can have side panels in fabric and PVC.



All Split Solution umbrellas can be made with double fabric.



All umbrellas can be customized with logos.

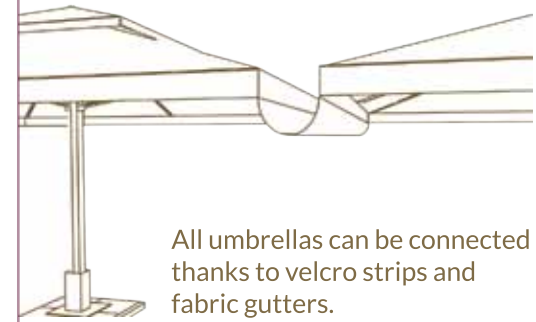

All umbrellas can be connected thanks to velcro strips and fabric gutters.

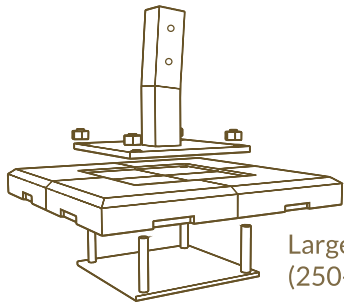

Large concrete base
(250-500-750 kg)

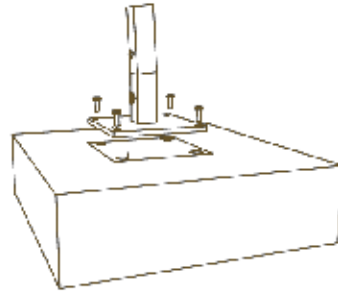

Inground bracket

WEIGHTS - ANCHORS

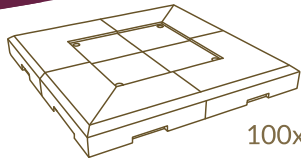

100x100x12 cm

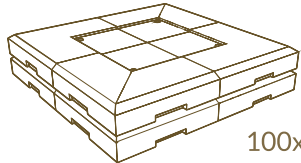

100x100x24 cm

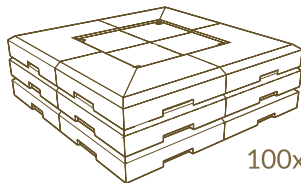

100x100x36 cm

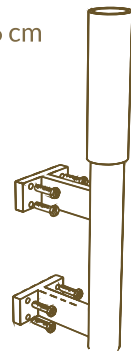

Wall Bracket
(Talento Steel & Gemelli Steel)
Size on request

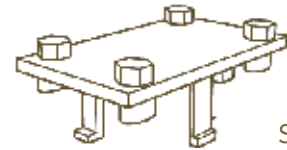

Small 15x30 cm

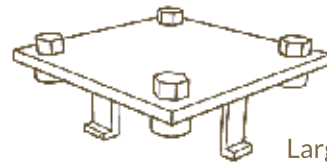

Large 46x46 cm

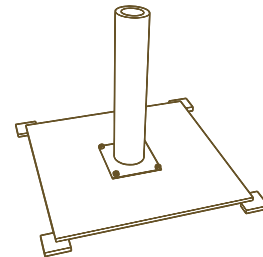

Metal plate (60 kg)
(Fiesole & Ciak)
Size on request

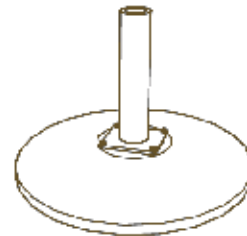

Round concrete base
(Fiesole & Ciak)
(50-70 kg, Ø60 cm)

Metal frame for air shipping
(weights not included)

Small
105x65x10 cm

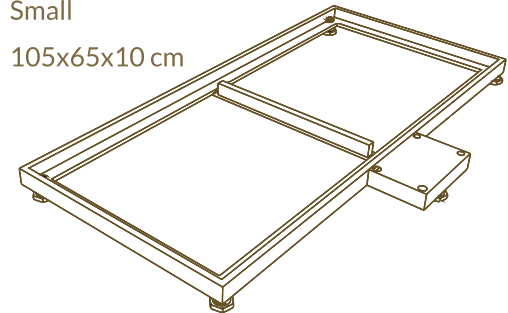

Large
105x120x10 cm

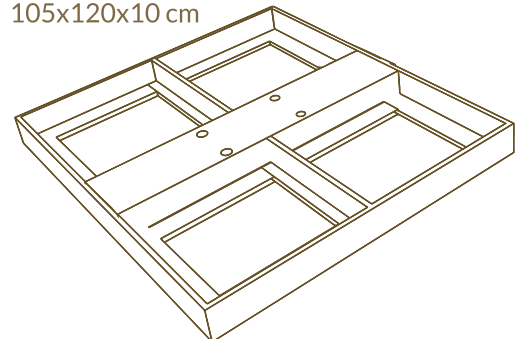

TABLE OF CONTENT



CENTRAL POST UMBRELLAS

10–11



SIDE POST UMBRELLAS

20–21



MULTIPLE CANOPY UMBRELLAS

30–31



FABRIC & COLORS

40–41



EXTRAS & WEIGHTS-ANCHORS

46–47



EDEN GARDEN

Editor
Sonja Vranešević

Left photos
Edengarden Archive

Right photos
Almin Zrno

DTP
Nataša Lučić

Istočno Sarajevo
2021.

