

ITALIAN DESIGN STORY

arflex

arflex
italian
design
stories



a journey through Italy

arflex programma un percorso che attraversa l'Italia per riscoprire, riassaporare la storia della cultura artigianale del saper fare.

Si relaziona attraverso architetture storiche e moderne, dove incontra persone diverse, che custodiscono esperienze di respiro internazionale.

arflex porta in questo viaggio la sua capacità di sintesi tra design, qualità, uso e cuore.

Creando luoghi di conversazione, di confronto, di divertimento e tutto diventa subito una grande famiglia.

Condividiamo con voi che collaborate con arflex le immagini realizzate.

arflex plans a journey through Italy to rediscover and savour the history of expert artisan culture.

It encompasses historical and modern architecture, meeting different people who are the guardians of international taste and ideas.

arflex brings to this journey its ability to synthesize design, quality, use and heart.

Everything immediately becomes a big family, by creating places of conversation, confrontation and fun.

We share with you, who collaborate with arflex, the realized images.



PRODUCTS INDEX

Sofas

9000	130
Arcolor	200
Bel Air	98
Ben Ben	340
Banah	92
Bonsai	366
Claudine	420
Cousy	260
Cradle	118
Deep Cradle	126
Faubourg	450
Frame	444
Hall	279
Hollywood	354
Hug love seat	216
K2	434
Lee	164
Low land	176
Marechiaro	48
Marenco	6
Naviglio	220
Pecorelle	238
Rendez-Vous	404
Soft Beat	430
Strips	72
Tokio	378

Armchairs

Algon	348
Botolo	248
Butterfly	374
Cradle	114
Cross	286
Delfino	42
Elettra	36
Fiorenza	66
Giulietta	440
Gloria	180
Hall	274
Hug	212
Jules	280
Jim	280
Katrin	452
Ladle	306
Leafo	270
Marenco	6
Pecorelle	232
Serena	426
Suppli	88
Tellin	394
Virgola	32

Chairs and stools

Botolo	248
Brianza	193
Elettra	326
Hug	218
Neptunia	322
Orfeo	330

Dormeuse and daybed

Banah	92
Bonsai	366
Cousy	269
Sigmund	300

Tables

Goya	106
Hug	316
Match	246

Small tables

Arcolor	194
Bonsai	140
Capilano	412
Cradle	160
Goya	112
Infinity	390
Island	362
Match	30-244
Sigmund	298
Tablet	398

Bookcases and sideboards

Alba	186
Match	240
Rubycon	416

Accessories and complements

Ciclope	41-367
Delfino pouf	122-361
Diva	329-410
Doge pouf	426
Match console	242
Papillon	46
Penta pouf	370
Ponti	334
Pouf	68-230
Sigmund writing desk	294
Threshold	152
Vela	258

MARENCO

by Mario
Marengo



The unmistakable design and wide modularity still make Marengo sofa a must-have in contemporary furniture. Designed by Mario Marengo in 1970, it is still a great classic of the Italian design. With this large-rounded cushions sofa, Mario Marengo has combined strength and comfort. In 2007 Marengo won the Wallpaper Design Awards Best Reissues.

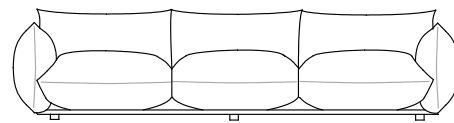

Marengo sofa



Marenco sofa, Match small table, Goya small table, Hall armchair - capsule collection Shanghai 07 category Leather "Top"

Marengo sofa,
Infinity small table





Marenco sofa, Tellin armchair, Infinity small table



Marengo armchair,
Arcolor small table

Marengo sofa,
Goya small table

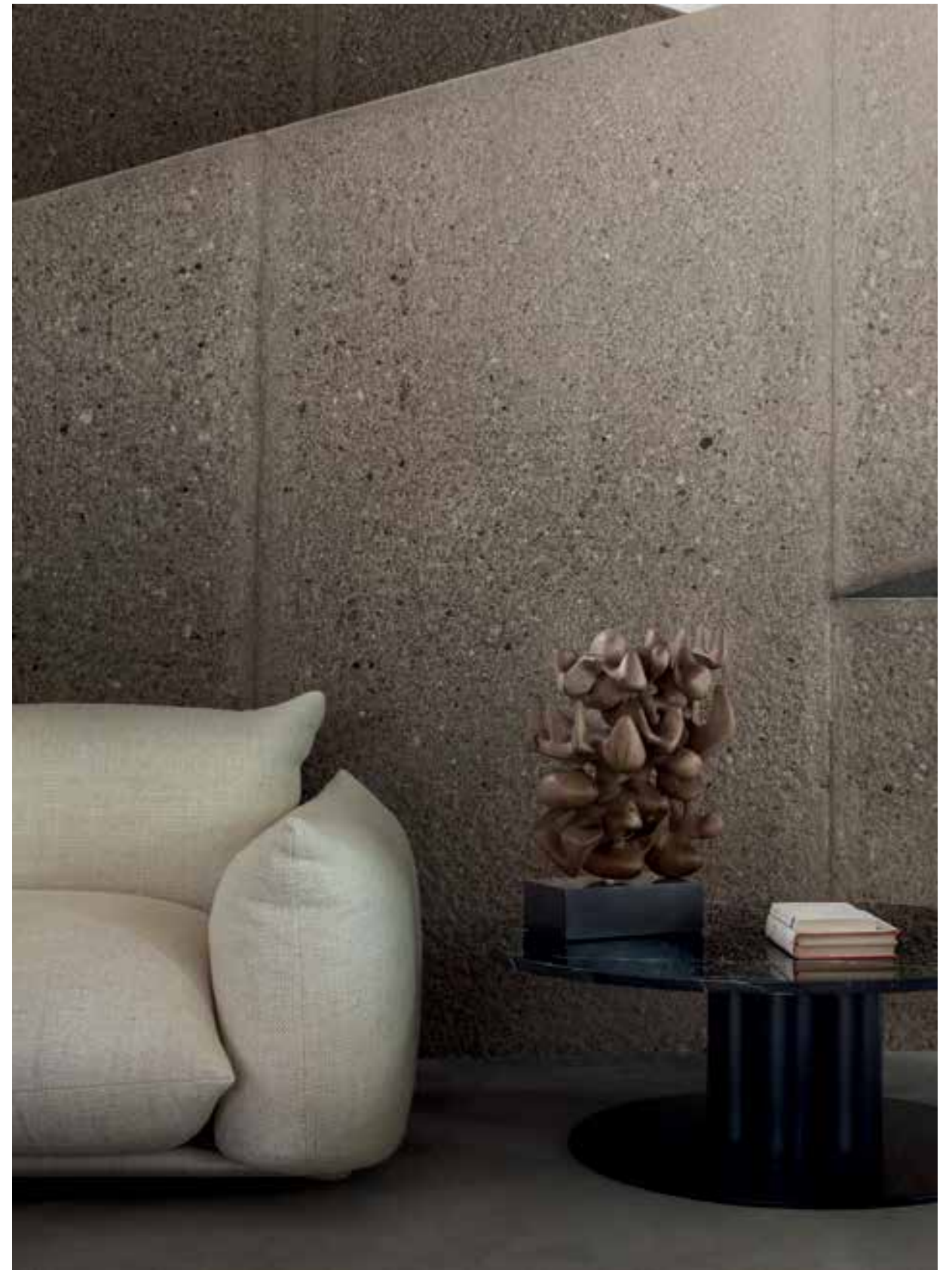



Marenco sofa, Marenco armchair, Tablet small table, Arcolor small table, Elettra armchair, Goya small table

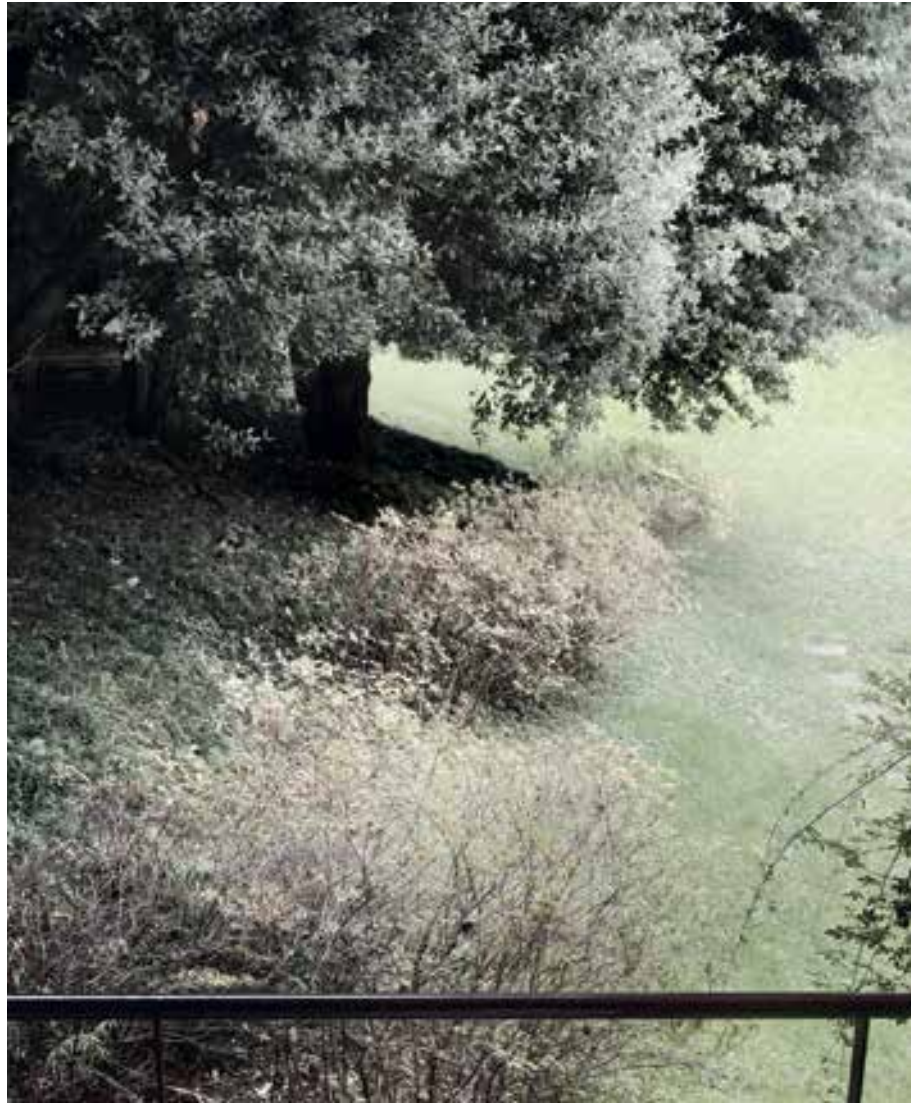

Marenco sofa, Marenco armchair,
Tablet small table, Arcolor small table, Elettra armchair





*Alba bookcase, Marenco armchair,
Arcolor small table*





**Marengo sofa, Cradle small table, Jules armchair,
Tablet small table, Rubycon sideboard**



Marengo sofa, Marengo pouf, Goya small table





Marengo sofa, Goya service





Marenco sofa, Match small table, Goya service, Virgola armchair - capsule collection

VIRGOLA

by Yaacov
Kaufman



Yaacov Kaufman designed an important sculptural form armchair, with a fun name, that recalls its shape not by chance: Virgola (comma).

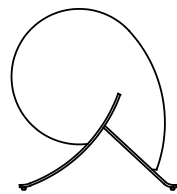

Virgola armchair - capsule collection



Virgola armchair - capsule collection



Virgola armchair

ELETTRA

by B.B.P.R.



B.B.P.R.'s first major design project dates back to 1946, after the war interlude and the reconstruction planning for Milan. Alongside furniture for home, the 1950s also saw the creation of the first furnishings for offices and public spaces, such as Elettra model.



Elettra armchair,
Tablet small table



*Elettra armchair,
Infinity small table*



*Ben Ben sofa composition B3,
Elettra armchair*





Elettra armchair



DELFINO

by Erberto
Carboni



Delfino armchair is a significant example of so-called “organic” furniture field, which develops in the fifties and which often draws its inspiration by the nature shapes, avoiding any imitative misunderstanding.



Delfino armchair , Papillon wall lamp , Penta pouf

**Delfino armchair,
Marengo pouf**



**Delfino armchair,
Tokio pouf**

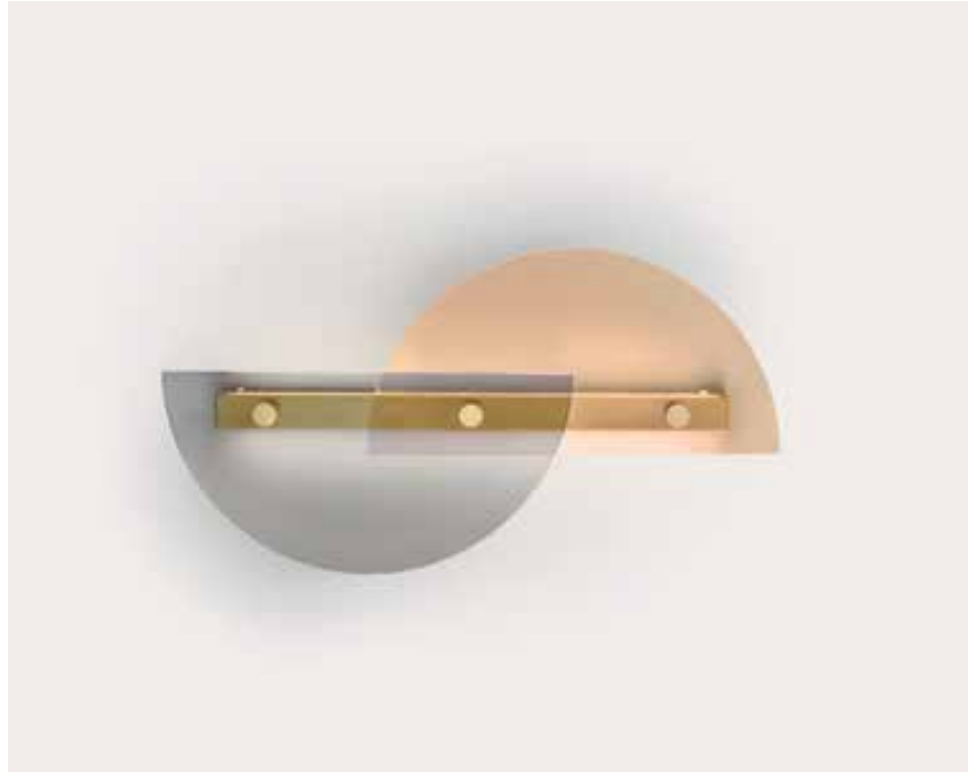

Papillon wall lamp



Papillon wall lamp

MARECHIARO

by Mario Marengo



The extreme formal essentiality of Marechiaro sofa, designed in 1976 by the architect Mario Marengo, still makes it a highly contemporary product, with an informal look and relaxing comfort. A modular seat system, that allows to create dynamic compositions, from geometric to curved lines, adapting to both living and hospitality areas.

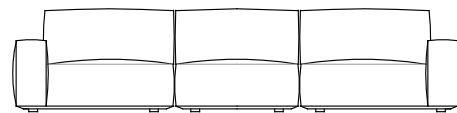

Marechiaro sofa composition MH08/B,
Goya small table



Marechiaro sofa composition MH08/B,
Goya small table







**Marechiaro sofa composition MH10,
Match small table**



Marechiaro sofa composition MH10, Match small table, Cradle armchair





Marechiaro sofa, Bonsai small table, Alba bookcase



Marechiaro sofa composition *MH11*, **Fiorenza** armchair,
Pouf, **Infinity** small table, **Island** small table, **Alba** bookcase





Goya table, Brianza chair, Alba bookcase

Marechiaro sofa composition MH11, Fiorenza armchair, Pouf, Infinity small table, Island small table

FIORENZA

by Franco Albini



In a fifties' Pirelli advertising page, Fiorenza armchair, designed by Franco Albini in 1952, has been used as a symbol image of foam rubber's potential, which fits like a glove and at that time, was the most technologically advanced material used in upholstered furniture.

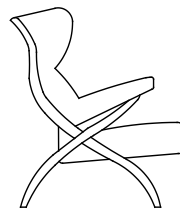

Fiorenza armchair, Sigmund small table



Fiorenza *armchair*, Pouf



Fiorenza armchair, Goya small table

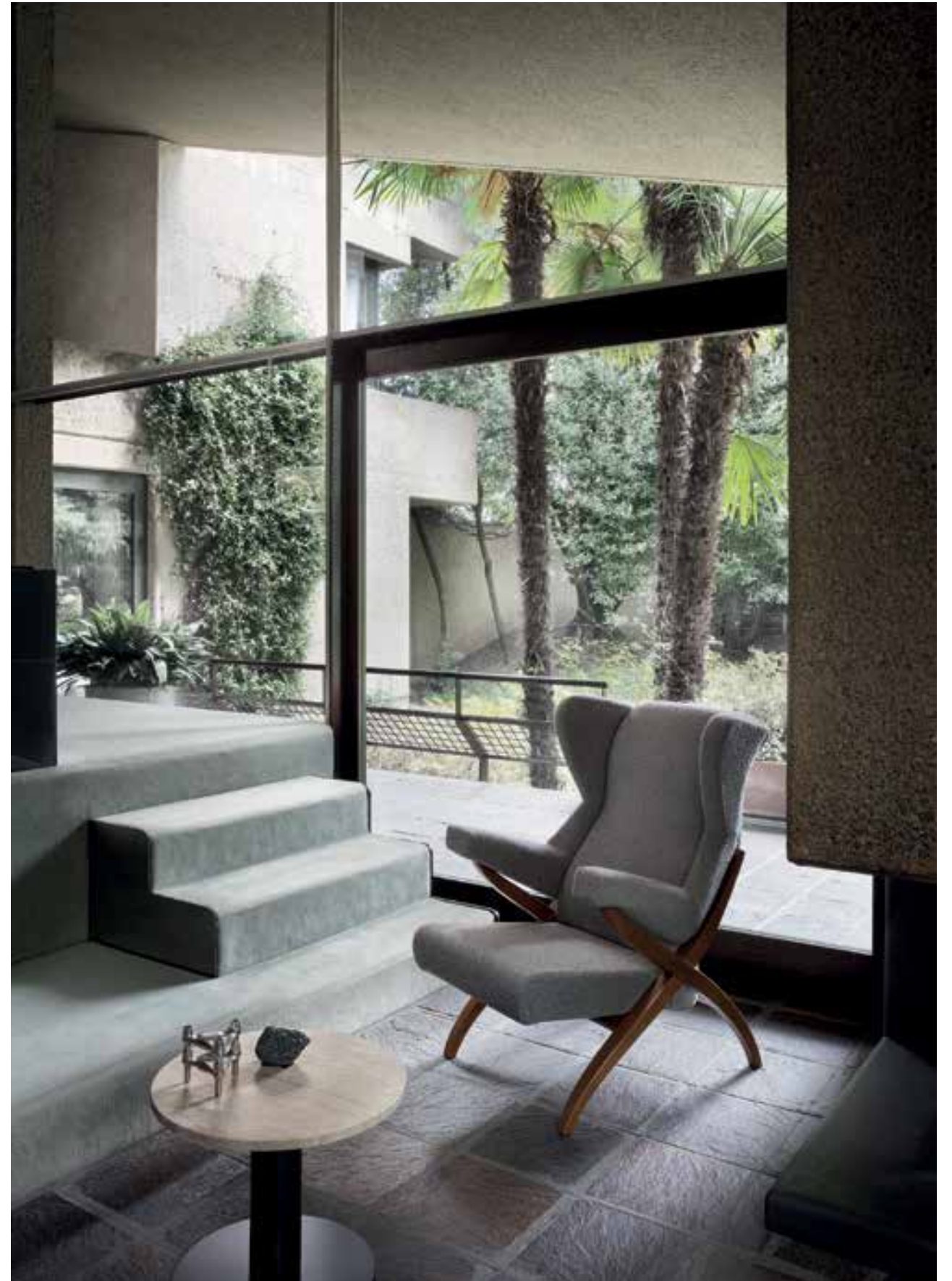

STRIPS

by Cini Boeri



At the beginning of the seventies, the architect Cini Boeri revolutionized the furniture market with her model, that stays nowadays an "evergreen": the modular sofa Strips, which belongs to arflex history. Surely it is one of the most famous products, designed in 1968, which awarded the prize Compasso d'Oro and it is displayed in several museums all over the world, such as Triennale in Milan, in Tokyo, Moma in New York, etc.

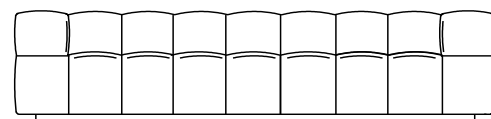

Strips sofa composition S3, Hall armchair – capsule collection Riga 01 category T6, Sigmund small table





Hall armchair – capsule collection Riga 01 category T6

Strips sofa composition S3, Sigmund small table, Goya table



Strips sofa, Jim armchair, Jules armchair, Arcolor small table, Alba bookcase

Strips sofa, Arcolor small table





Strips sofa composition S15, Cradle armchair, Cradle small table



Strips sofa composition S20, Sigmund small table, Goya service, Goya small table



Strips sofa composition S20, Goya service, Goya small table



Strips sofa composition S18, composition S19, composition S20



Strips sofa composition S20, Goya small table, Goya service



SUPLÌ

by Luca
Nichetto



Supli is an inviting and elegant armchair. Soft and sinuous curves exude warmth and embody a near perfect spatial anchor for rest and relaxation.

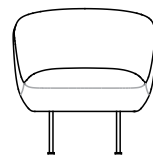

Supli armchair, Goya service



Supli armchair,
Sigmund small table



BANAH

by Luca
Nichetto



Banah was born with the intent to create a bold design, that breathes references to all the icons of the company. Its most recognisable features meet and find a balance through an organic approach oriented to move away from archetypes. Avoiding any symmetries, the sofa acquires an irregular shape, as if born from a spontaneous drawing.

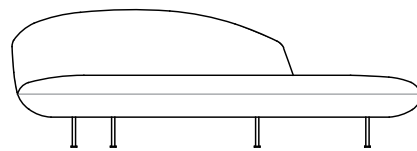

Banah *dormeuse*, Arcolor *small table*, Vela *screen*





Banah *dormeuse*

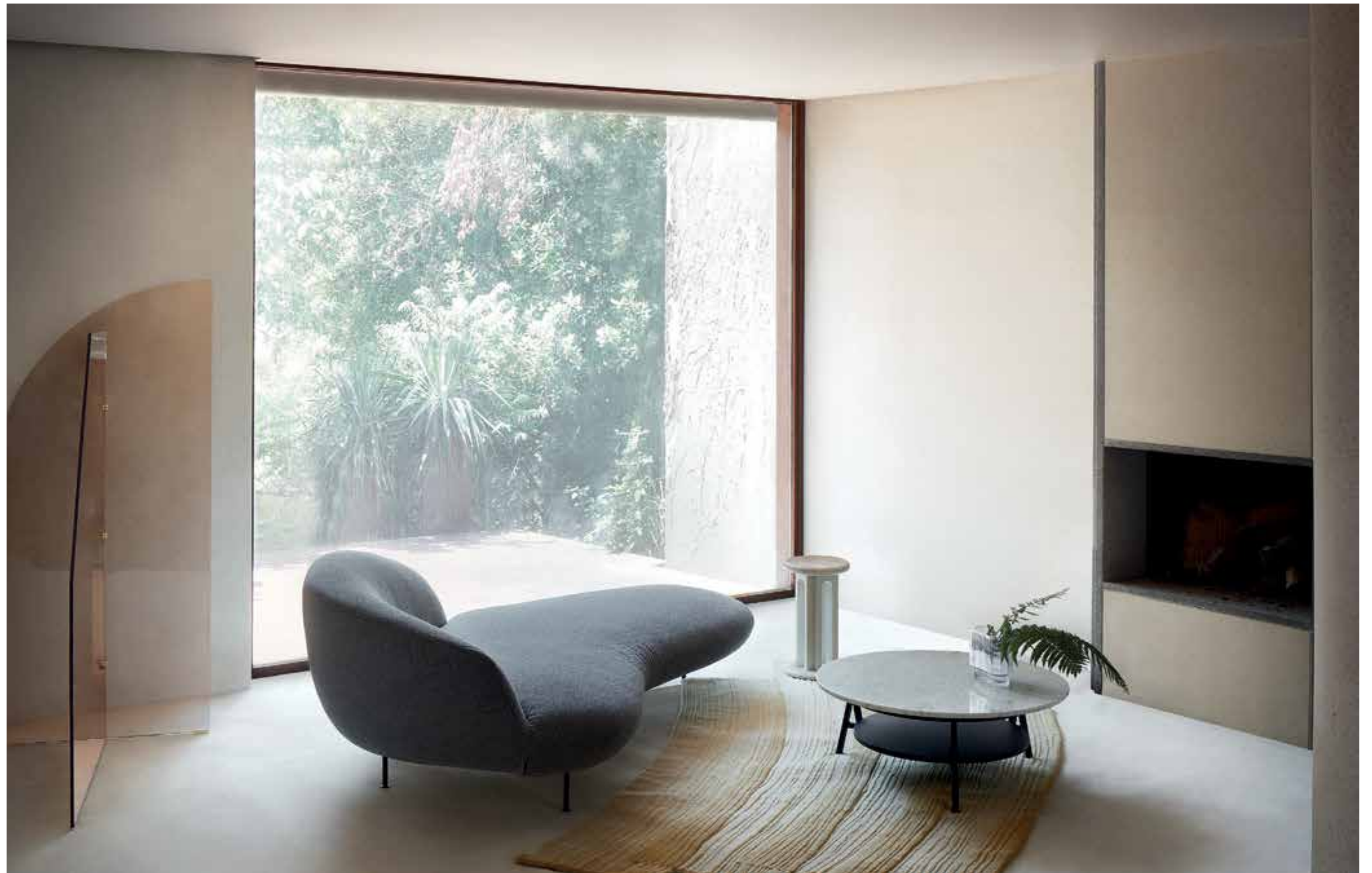

Banah dormeuse, Cradle small table, Arcolor small table, Vela screen

BEL AIR

by Claesson
Koivisto Rune



Seating system with simple and sober elegance, proportioned to achieve an airy horizontality, that communicates a quintessentially Italian 'Optimistic Modernism'. There is also a careful upholstery detailing around the outer surfaces of each element.

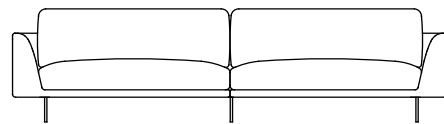



Bel Air sofa composition AB08 , Goya small table, Goya service



Bel Air sofa composition AB15, Hall armchair, Goya small table, Goya service



Bel Air sofa composition AB04, Match small table, Arcolor small table

GOYA
by arflex

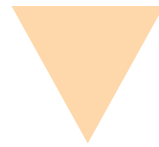

Goya is a family of tables, small tables and service tables with round, essential and simple lines, with a great visual impact, that allows to adapt itself to any environment, completing it with elegance.

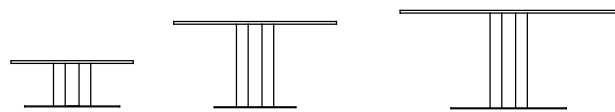

Goya table, Gloria armchair

Goya table,
Botolo armchair

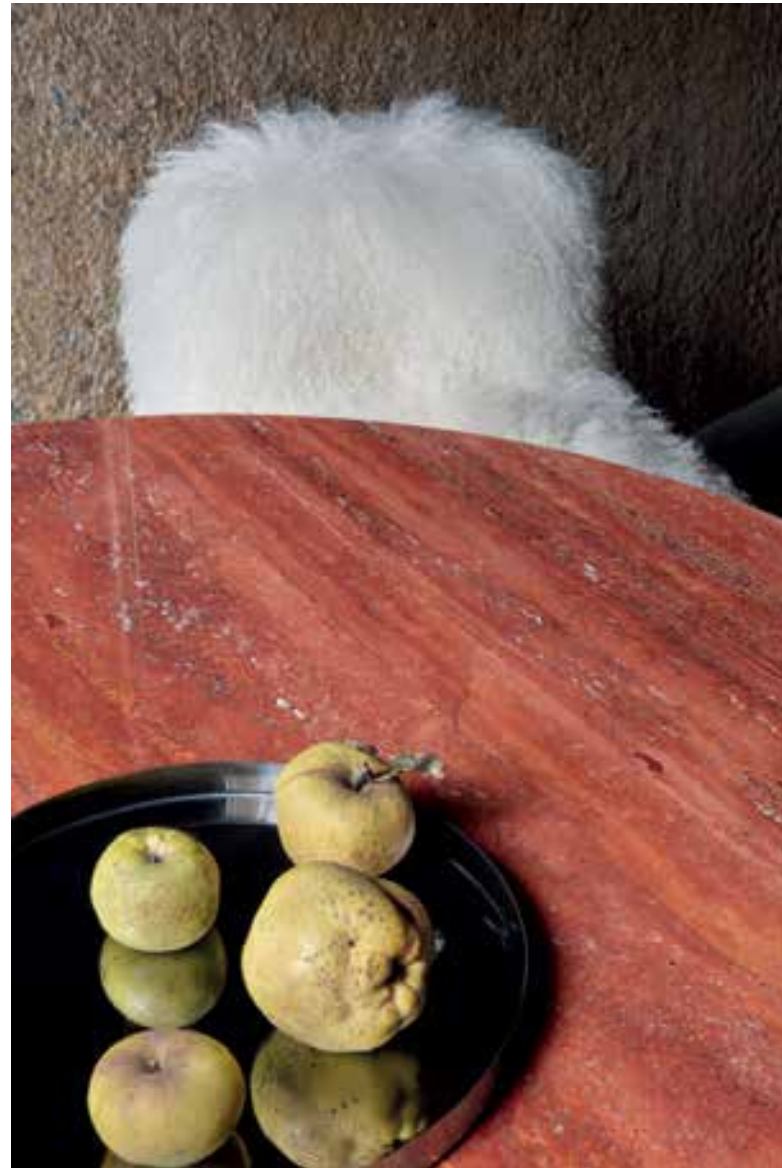

Goya table,
Neptunia chair



Goya small table,
Goya service



Goya small table, Lee sofa

CRADLE

by Neri&Hu



The armchair and the sofa draw both from the rich lineage of Italian furniture, known for its sculptural and bold shapes, as well as from the modernist sensibility, that demands an honest structural expression. Rather than conceal the frame and attempt to make the models lift from the ground, the elegant crafted supporting elements become themselves the highlight of the model.

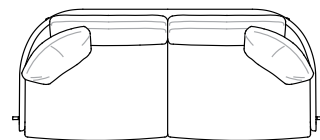
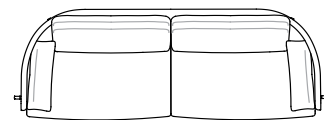

Cradle armchair, Cradle service, Delfino pouf



Cradle armchair, Marechiaro sofa



Cradle armchair, Capilano small table



Cradle sofa, Cradle armchair, Cradle service, Sigmund small table, Delfino pouf, Papillon wall lamp

Cradle sofa



Cradle sofa, Cradle service, Delfino pouf



Cradle sofa, Cradle service, Cradle small table, Delfino pouf, Arcolor small table



Cradle armchair, Cradle service, Ponti writing desk

Deep Cradle sofa, Cradle small table





Deep Cradle sofa,
Cradle small table,
Goya table



9000

by Tito
Agnoli



At the end of the 60's the designers started realizing mini and versatile furniture, conceived for compact and multitasking domestic spaces. arflex, always engaged in a constant work of research and realizations, presents 9000, by Tito Agnoli, a series of compact and variously articulated seats. The small dimensions and the easy modularity represent a valid solution to different furnishing problems, both for home and collective environments.

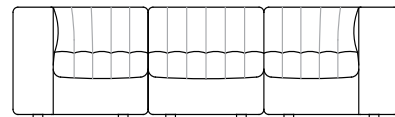



9000 sofa composition NV11, 9000 armchair, Sigmund small table, Goya service

9000 armchair,
Alba bookcase





9000 sofa composition NV03 , Sigmund small table, Ponti writing desk, Botolo armchair



9000 armchair



9000 sofa, 9000 pouf, Bonsai small table, Arcolor small table, Suppli armchair



9000 sofa, 9000 pouf, Bonsai small table, Arcolor small table, Suppli armchair



9000 sofa, 9000 pouf, Bonsai small table



9000 sofa composition NV04



9000 sofa composition NV06



9000 sofa composition NV09



9000 sofa composition NV08



9000 sofa composition NV13



9000 sofa composition NV12



9000 sofa composition NV11



9000 sofa composition NV10

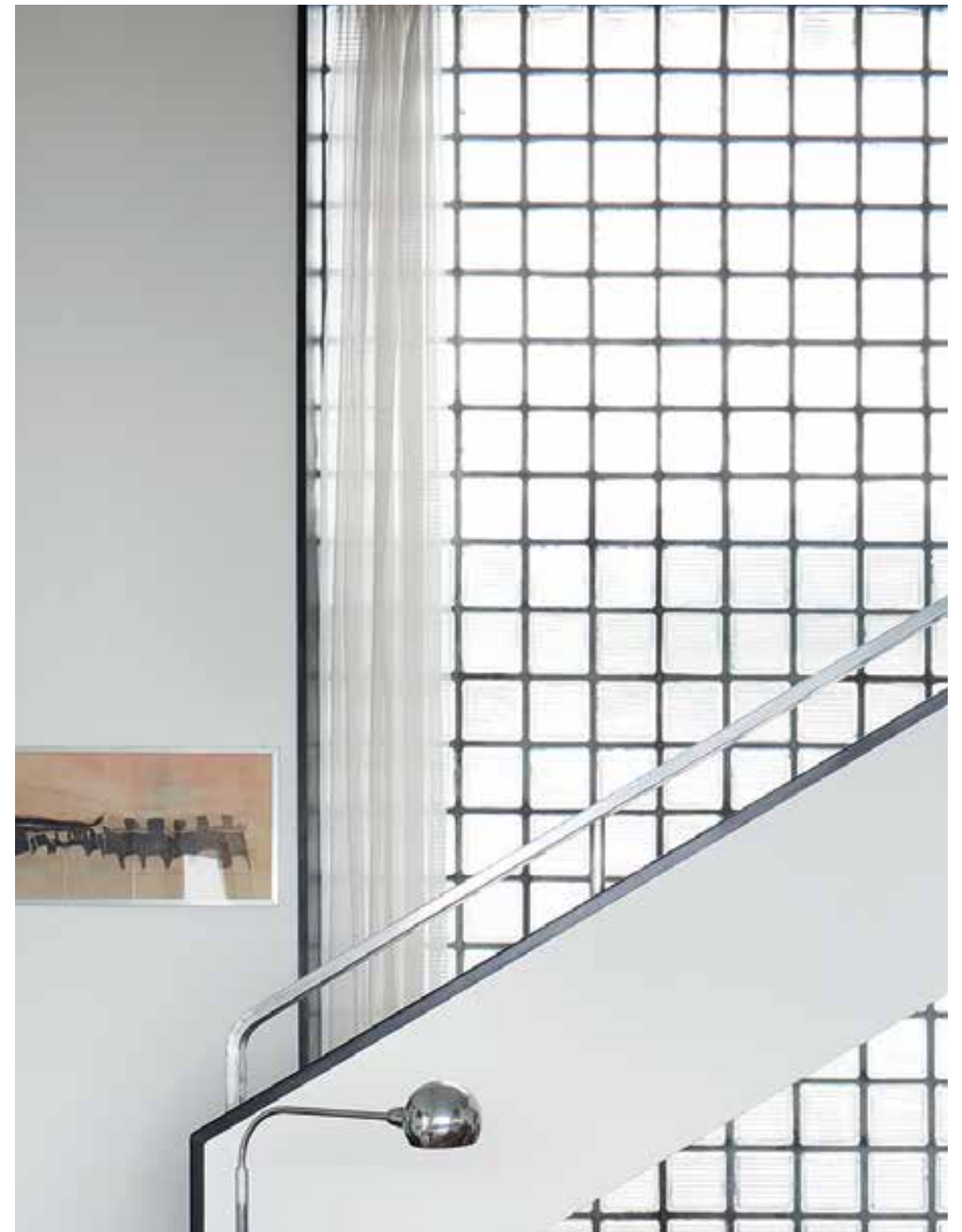



9000 sofa composition NV07-B, Botolo armchair, Goya service



9000 sofa composition NV07-B,
Goya service



THRESHOLD

by Neri&Hu

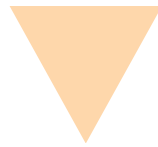

The Chinese word 'jian' can be translated into "gap" or "interval," but it is also the unit word for a "room." In an architectural sense, this term can be understood as a threshold condition—the physical mediation between two contrasting spatial environments, such as interiority and exteriority, or public and private—but it also implies that the threshold is not a passive mechanism, having the potential to actively alter spatial configurations and relationships.

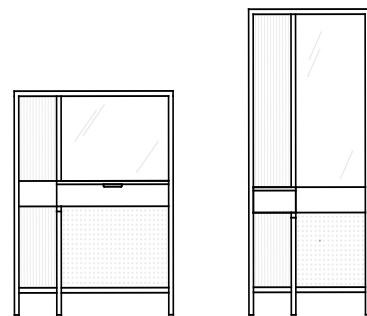

Threshold low mirror cabinet, Botolo armchair



Threshold *low mirror cabinet*



Threshold *low mirror cabinet*



Threshold *high mirror cabinet*

Threshold *high mirror cabinet,*
Sigmund *bench*



CRADLE

by Neri&Hu

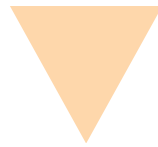

Its characteristic is based on the structure: a classic triangular construction, that is repeated several times around the model, so that you can admire it from every point of view.

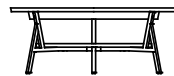

Cradle small table, Claudine sofa

Cradle *small table*,
Hollywood *sofa*



LEE

by Fabrizio
Ballardini



The simple image makes the sofa reassuring in its contemporaneity. Lee is a modular seating system, that allows the adjustment to countless furnishing spaces.

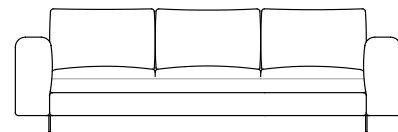

Lee sofa composition L07, Match small table, Island small table





Lee sofa composition L07, Gloria armchair, Match small table, Sigmund daybed, Island small table, Capilano small table

Lee sofa,
Capilano small table





Lee sofa composition L01, Cradle small table





Lee sofa, Goya small table, 9000 armchair



Lee sofa



LOW LAND

by Fabrizio
Ballardini



Its understated image makes it reassuringly contemporary. Low Land is an elegant, contemporary seat system, that gives the customer the opportunity to create and “customise” his own comfort.

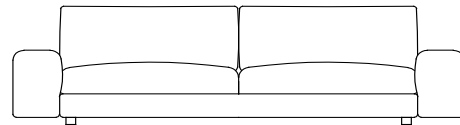

Low Land sofa, Island small table



Low Land sofa, Ladle armchair, Island small table, 9000 pouf, Rubycon sideboard

GLORIA

by Claesson
Koivisto Rune



“Gloria is all about her dress. She can look smart for when she goes to work, dress up when going to a party, or put on something cosy when staying in. Dressed her as you want her to be!”

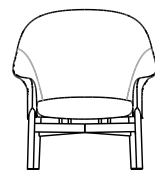
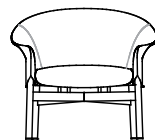

Gloria armchair, Sigmund small table

Gloria armchair,
Match small table





Gloria armchair, **Goya** table

ALBA

by Bernhardt
& Vella

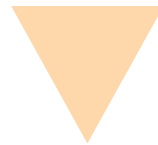

Alba is a bookcase for exhibiting and containing, with an extraordinary creating versatility.

The coloured glass shelves allow to create round compositions, thanks to the fixing with one single joining element. The coloured glass half circle-shape element creates also a geometric decoration, in addition to the function of hanging the books.

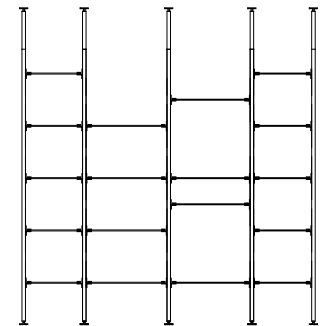

Alba bookcase, Delfino pouf



Alba bookcase



Alba bookcase, Bonsai small table, Marechiaro sofa, Botolo armchair

*Alba bookcase, Goya table,
Botolo armchair, Marengo armchair*

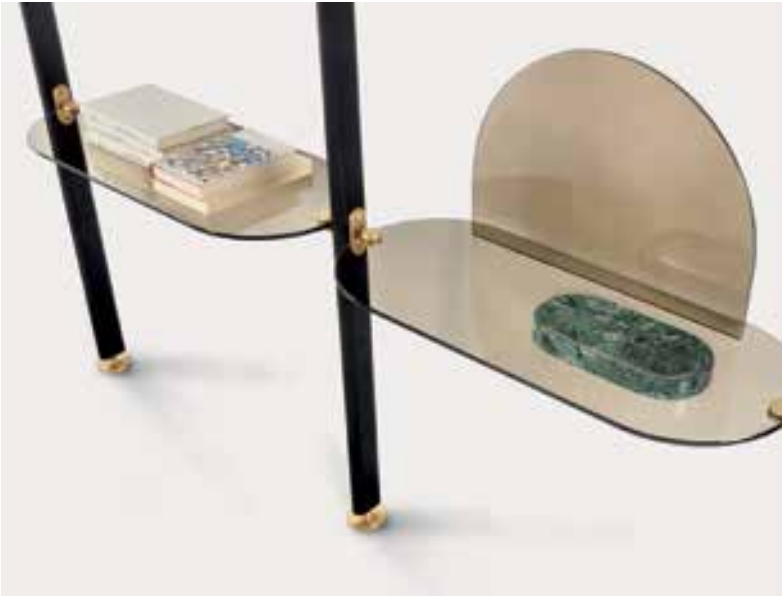



Alba bookcase, Goya table, Brianza chair, Marechiaro sofa

ARCOLOR

by Jaime Hayon

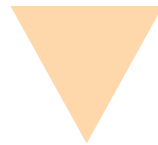

Hayon employed from the beginning the disciplined use of the arch, to create something more organic. A strong coherence and rhythmic repetition of the shapes recall the iconic Roman aqueduct.

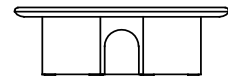
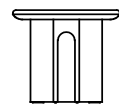
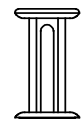

*Arcolor small table,
Arcolor sofa*





Arcolor small table ,Hug armchair



Arcolor small table



Arcolor small table , Algon armchair

ARCOLOR

by Jaime Hayon



To develop Arcolor sofa for arflex, Jaime Hayon wanted to create a modular system, designed around the classical geometry of the arch.

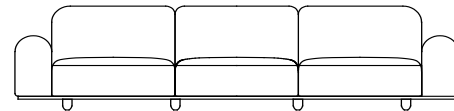

*Arcolor sofa composition AR02, Gloria armchair - capsule collection Forest 01 category Leather "Super",
Arcolor small table, Tablet small table, Match console*



Arcolor sofa composition AR02, Gloria armchair - capsule collection Forest 01 category Leather "Super",
Arcolor small table, Tablet small table, Match console



Arcolor sofa composition AR07,
Arcolor small table,
Leafo armchair





Arcolor sofa



Arcolor sofa composition AR03, Hug love seat sofa, Hug armchair, Infinity small table, Capilano small table

Arcolor sofa composition AR03



Arcolor sofa composition AR03, Hug armchair, Infinity small table, Capilano small table

HUG

by Claesson
Koivisto
Rune



A friendly, recognisable gesture, that encompasses all of the aspects and also speaks directly to the heart – the hug. The friendly and welcoming gesture, seen most clearly in the ‘open-armed’ position of the armrests, is meant as a universal invitation: “Come, sit with me a while and I’ll put you at ease”.

-by Claesson Koivisto Rune

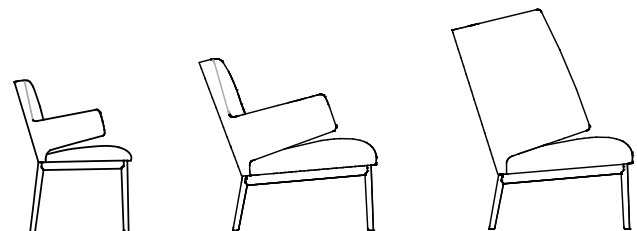

Hug armchair
Arcolor small table



Hug armchair, Arcolor small table, Elettra chair



Hug armchair

Hug love seat sofa



Hug love seat sofa



Hug chair, Alba bookcase,
Match table, Hug love seat sofa



NAVIGLIO

by Umberto
Asnago



Rigorous shape for the seat system Naviglio, but pleasantly softened in the lines, thanks to a competent use of the materials. A linear and modular sofa, characterized by a light and generous aesthetic, which makes it comfortable in the proportions and in spaces.

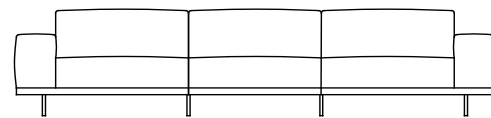

*Naviglio sofa, Hug armchair, Marechiaro pouf,
Arcolor small table, Tablet small table*





Naviglio sofa, Hug armchair, Marechiaro pouf, Arcolor small table, Tablet small table, Match console



Naviglio sofa, Cross armchair – capsule collection Shanghai 06 category Leather “Top”, **Goya small table**



Naviglio *sofa*



Naviglio sofa, Cradle armchair, Bonsai small table



Naviglio sofa, Bonsai small table



Naviglio sofa, Bonsai small table, Neptunia chair, Pouf

PECORELLE

by Cini Boeri



The architect Cini Boeri tells that she was inspired by the works of Christo Vladimirov Javacheff and Jeanne-Claude Denat de Guillebon, masters in the art of landscape painting. Nature prevails and becomes the inspiring muse of this piece of design.

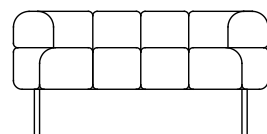
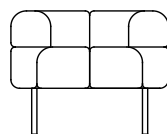

Pecorelle *armchair*,
Claudine *sofa*,
Cradle *small table*



Pecorelle armchair, Goya table





Pecorelle sofa



Pecorelle sofa, Match console

MATCH

by Bernhardt
& Vella

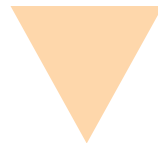

The project was born from an industrial shelves system.
The junction, that joins the structure with the shelf, becomes a precious and decorative element in brass.
The system can be stacking and allows to create with the same elements also small tables and bookshelves with different heights, console and table.

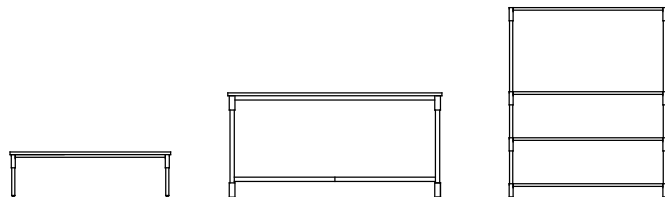

Match bookcase, **Hall** armchair

Match console



Match small table



Match bookcase, Tellin armchair

Match table, Botolo armchair, Alba bookcase



Match table,
Alba bookcase,
Botolo armchair



BOTOLO

by Cini Boeri



Cini Boeri designed Botolo in 1973, giving life to a new design style, where you could choose the height of the legs to have a dining chair in the high version or a style, at that time modern, “the living at a low level”, a way of living and sitting on the ground. In the legs there are wheels to move it easily.

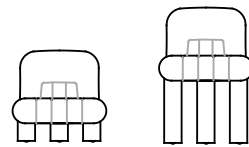

Botolo armchair, Goya table, Alba bookcase



Botolo armchair, Island small table, Tokio sofa

**Botolo armchair, Marechiaro sofa,
Bonsai small table, Alba bookcase**





Botolo armchair, Hug table



Botolo armchair, Ponti writing desk

**Botolo armchair, Vela screen,
Match console**



Vela screen

COUSY

by Vincent
Van Duysen



Cousy, designed by Vincent Van Duysen, is a sofa characterised by light lines and proportions, that make it suitable for all types of living. A sofa with a minimalist and rigorous structure, for a comfortable and decorative effect at the same time.

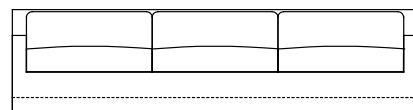

Cousy armchair, **Vela** screen



Cousy armchair, Leaf armchair, Goya small table, Vela screen



Cousy sofa, Elettra armchair, Tellin armchair, Tablet small table

Cousy sofa, Elettra armchair,
Tablet small table, Match bookcase





Cousy dormeuse, Sigmund small table

LEAFO

by Jaime
Hayon



A simple chair, that can be placed in small and large spaces. The special shape is inspired by a leaf falling from a tree, that becomes a symbol of comfort. It invites you to take a rest and relax.

The ergonomics of the backrest provides excellent support for the back, allowing a sitting position, that can be classified between a chair and a chaise longue.





Leafo armchair, Arcolor small table



HALL

by Roberto
Menghi



We are at the end of the '50s: an interesting series of armchairs and sofas, designed by Roberto Menghi, called Hall, joins arflex collection. In these years the design tends not to be only for "élite". The birth of other magazines in the wake of Domus, Triennale, the specialized exhibitions manage to raise wider layers of distributors and audience.

The armchair Hall receives in 1959 the honourable mention for Compasso d'Oro.

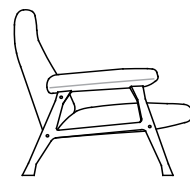

Hall armchair – capsule collection Riga 01 category T6,
Strips sofa,
Sigmund small table



Hall armchair,
Tablet small table



Hall sofa, Tablet small table, Match small table



JIM & JULES

by Claesson Koivisto
Rune



Named after the famous French movie by Francois Truffaut, Jules & Jim are two easy chairs with a high degree of seating comfort.

Jules is the smaller and Jim the larger one.

Though the difference in size, both armchairs share the same shape (round geometry), which makes them easy to use and place in an architectural context.

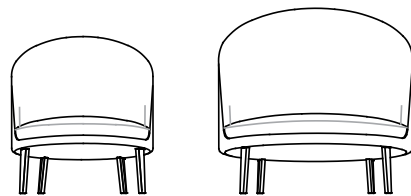

Jules armchair,
Arcolor small table



Jim armchair, Jules armchair

Jim armchair,
Bonsai sofa



CROSS

by Marcello
Cuneo



The armchair was born from a very simple idea: two tubes bent into a U shape and linked together by a light alloy joint. On the two structures, the covers are slipped into and carry the cushions of the seat and backrest. The architect Cuneo had a special mention at XII Compasso d'Oro, in 1979, for this intuitive idea.

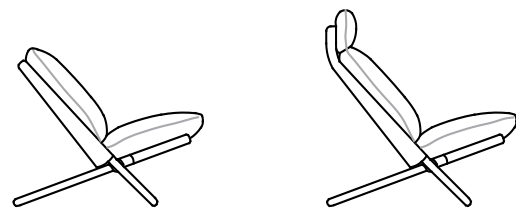

Cross armchair

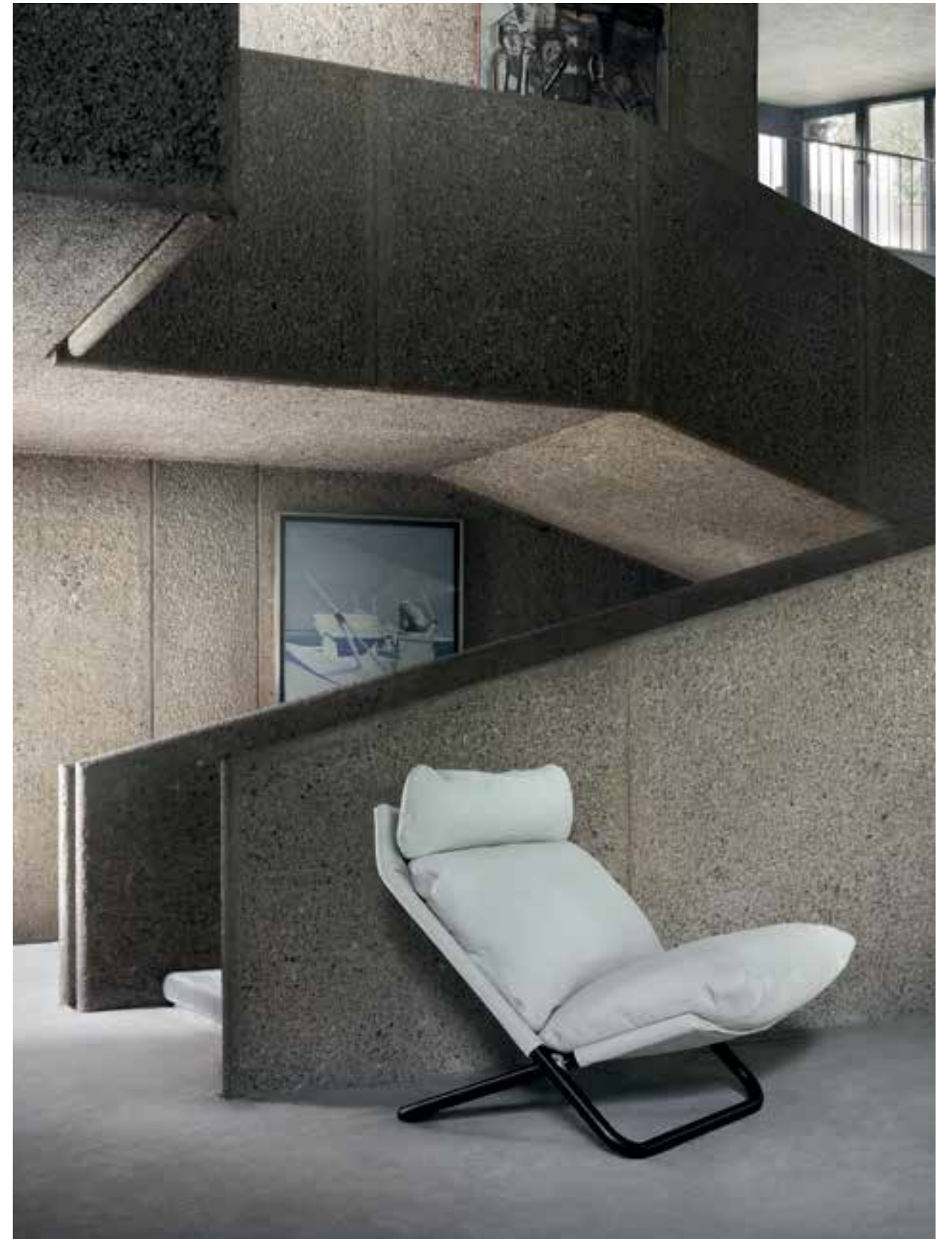



Cross armchair high backrest – capsule collection Shanghai 06 category Leather “Top”

Cross armchair low backrest, Island small table



Cross armchair, Tokio sofa



SIGMUND

by Studio Asai

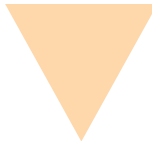

Dedicated to Freud and inspired by reading as a revelation of the imagination, Sigmund collection initially consists of two pieces of furniture: a daybed and a bench. Then as a variation on the same theme, its design extension is completed with a desk and small tables.

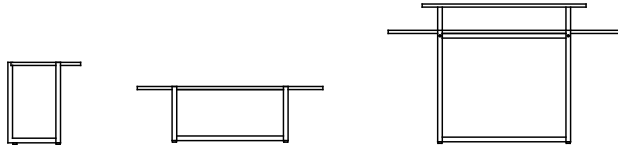

Sigmund writing desk, Elettra chair



Sigmund *small table*,
Sigmund *bench*



Hall *armchair* – capsule collection *Riga 01* category *T6.*, Sigmund *small table*

SIGMUND

by Studio Asai



Dedicated to Freud and inspired by reading as a revelation of the imagination, Sigmund collection initially consists of two pieces of furniture: a daybed and a bench. Then as a variation on the same theme, its design extension is completed with a desk and small tables.

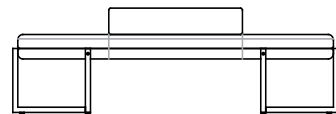
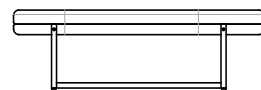

Sigmund bench, Ciclope mirror



Sigmund bench,
Sigmund small table





Sigmund *daybed*, Goya *small table*

LADLE

by Luca
Nichetto



The armchairs Ladle want to re-edit the design with a contemporary point of view, but above all the feeling and the comfort of the 60' years classic armchairs. Ladle, like the big wooden spoon, collects the body shape, giving a very soft and embracing comfort.



Ladle armchair, Sigmund bench, Sigmund small table

Ladle armchair

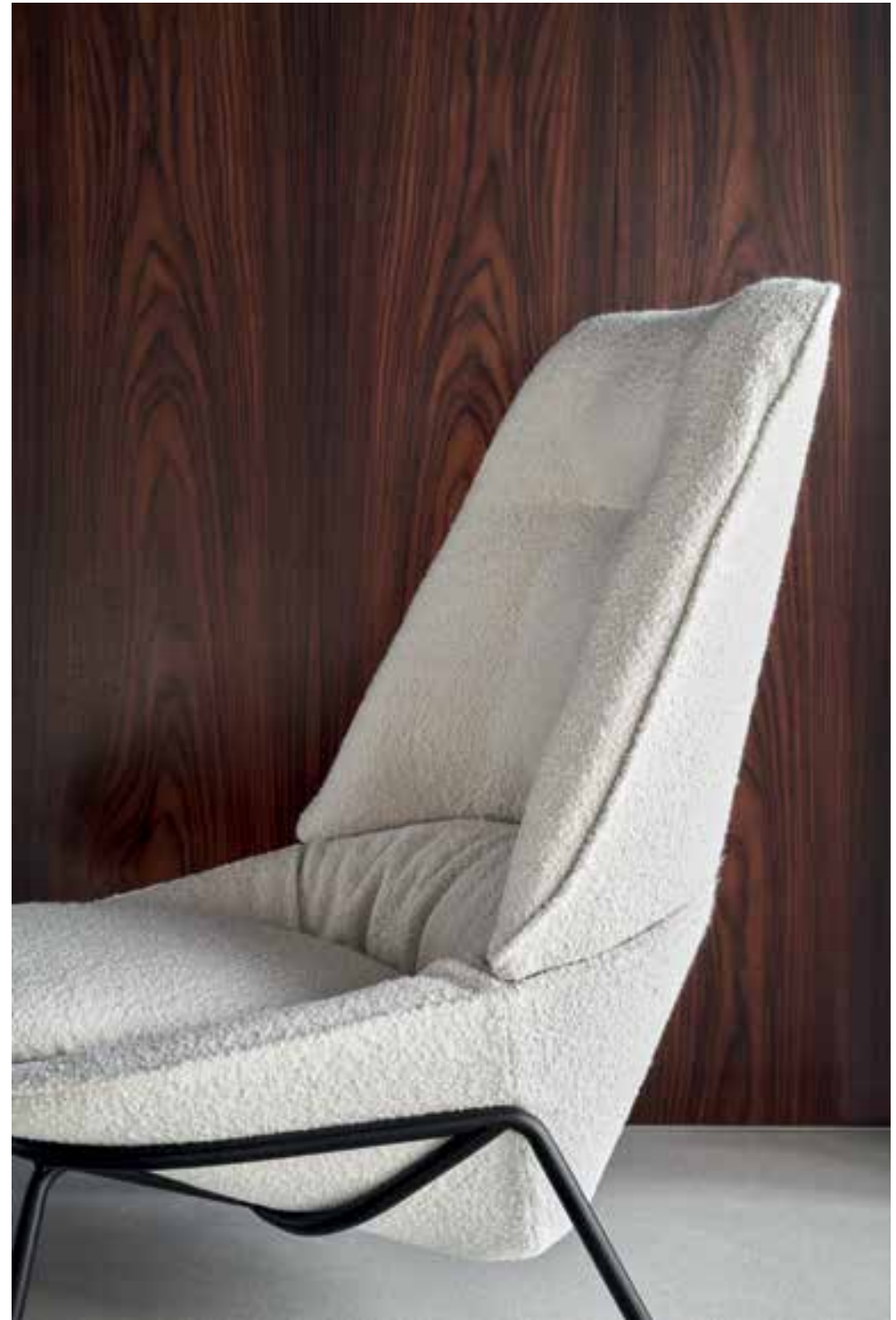



Ladle armchair,
Rubycon sideboard





Sigmund daybed, Match small table, Ladle armchair, Ladle pouf



Ladle armchair, Ladle pouf,
Match small table, Ponti writing desk



HUG

by Claesson
Koivisto
Rune

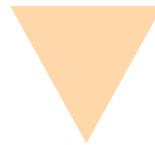

The designers Claesson Koivisto Rune have enhanced Hug family, starting from the initial idea and creating a table, with a linear and clean design, but rich in construction details, which allows to place it into sophisticated and elegant environments.



Hug table, Botolo chair



Hug table, Botolo chair





Hug table, Elettra chair, Neptunia chair

NEPTUNIA

by B.B.P.R.

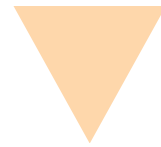

Neptunia chair resumes the soft and welcoming shapes and the proportions of Elettra series, keeping the pure and amazing lines of the '50s design. The armrests give a snug fit, that summarizes the formal elegance and the ideal comfort.



Neptunia chair,
Hug table, Elettra chair



Neptunia chair, Ponti writing desk



ELETTRA

by B.B.P.R.

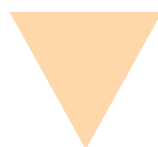

B.B.P.R.'s first major design project dates back to 1946, after the war interlude and the reconstruction planning for Milan. Alongside furniture for home, the 1950s also saw the creation of the first furnishings for offices and public spaces, such as Elettra model.





ORFEO

by B.Belgiojoso

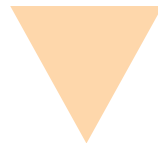

Orfeo was inspired by Elettra chair, designed in the 1950s, for the first furnishing models, created for offices and public area. The stool, thanks to its attractive design and exceptional comfort, adapts perfectly to every requirement.





Orfeo stool



PONTI

by Claesson

Koivisto

Rune

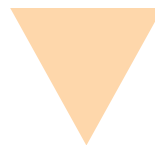

Inspired by the elegant beauty of bridges and by the works of the famous Milanese designer with the same name, a writing desk was designed, having clear and tidy lines, at the same time rigorous and squared.

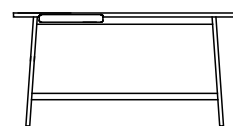

Ponti writing desk, Cradle armchair, Cradle service



Ponti writing desk, Botolo chair





Ponti writing desk

BEN BEN

by Cini Boeri



Cini Boeri starts again from Bengodi model, designed in 1974, arflex's choice, sure that it would have been liked, today as well as then, creating a seating system composed of curved elements, that is perfectly suitable for home and contract environments.

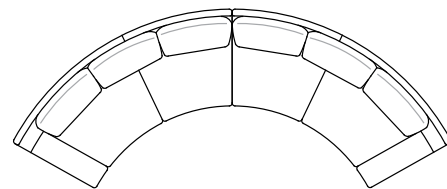

Ben Ben sofa composition B3,
Capilano small table





Ben Ben sofa composition B3, Elettra armchair

Infinity small table, Capilano small table



ALGON

by Luca
Nichtetto



Algon was developed, melding Scandinavian simplicity with a patterned quilted upholstery. Available with low backrest, that has a strict formality, and with high backrest, that allows a sense of privacy, perfect for hushed late-night conversations or a solitary moment of respite.

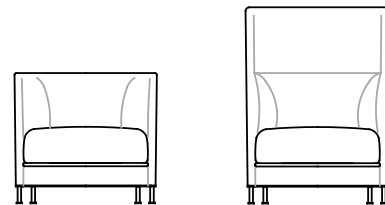

Algon armchair, **Tablet** small table

Algon armchair

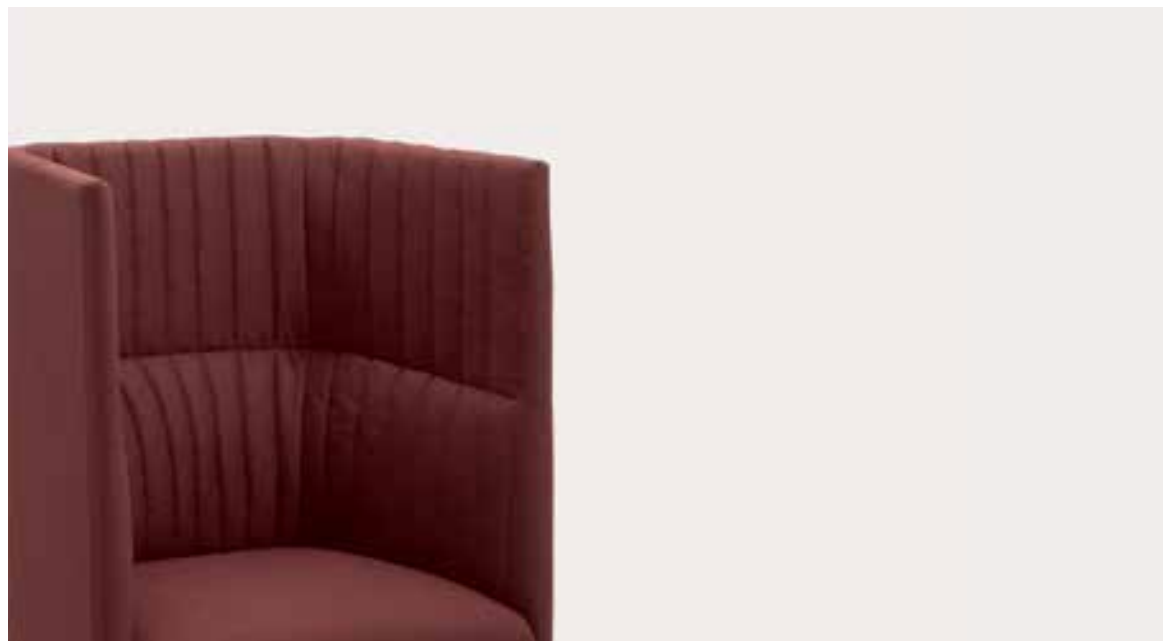

Algon armchair, Capilano small table

*Algon armchair,
Arcolor small table*



HOLLYWOOD

by Claesson Koivisto

Rune



In 2012, Claesson Koivisto Rune designed Hollywood, a linear and modular sofa, characterised by a light and well-proportioned aesthetic with a Scandinavian flavour accent, which makes it welcoming in living and hospitality environments.

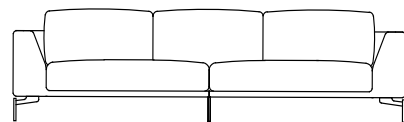





Hollywood sofa composition H10, Delfino armchair, Delfino pouf, Penta pouf, Island small table



Hollywood sofa composition H10, Delfino pouf, Penta pouf, Island small table

ISLAND

by Bernhardt
& Vella

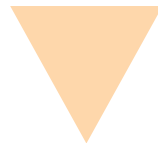

The minimal design of the structure is generated by an idea of subtraction of the material.

Thanks to their plurality of shapes, Island small tables are easily adaptable.

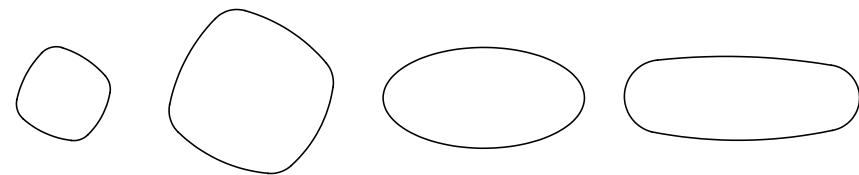

Island small table, Lee sofa

Island small table, Tokio sofa



Island small table, K2 sofa

BONSAI

by Claesson

Koivisto

Rune



Bonsai seating collection is inspired by reflections upon Japanese aesthetics and culture. The seats are characterised by soft, curved forms. These inviting, friendly shapes are reminiscent of the bushes and shrubs, found in gardens all over Japan, that have been cultivated and trimmed in order to create beautiful, soft, 'organic', cloud-like shapes.

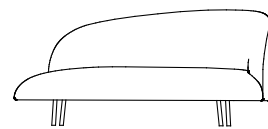

*Bonsai sofa, Ciclope mirror,
Doge pouf, Arcolor small table*





Bonsai sofa



Bonsai sofa, Match small table

PENTA

by Claesson

Koivisto

Rune



The perfect circle is generically a geometric shape and does not show enough character. In contrast, the pentagon is the best form to combine a certain geometric integrity without having to fit into the surrounding order. In other words: it has a distinct shape. It can be placed wherever one wishes and always looks well placed.

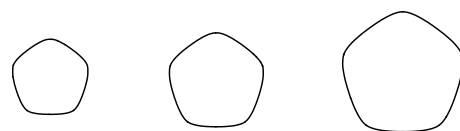

Penta pouf, Marengo sofa, Cradle small table

Penta pouf, Match console, Goya service



BUTTERFLY

by Mauro Lipparini



The design of Butterfly armchair plays on the combination of shapes and materials, that compose it. Its soft line makes it comfortable and elegant at the same time.

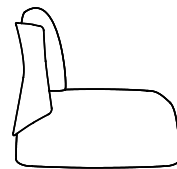

Butterfly armchair, Tokio sofa, Goya service

Butterfly armchair,
Capilano small table



TOKIO

by Claesson

Koivisto

Rune



The collection can be grouped in an almost endless possibility of combinations: free-standing, in a large room as a seating island, but also grouped in a more traditional sofa configuration.

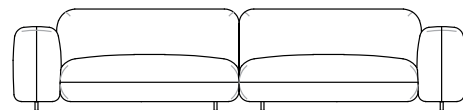

Tokio sofa composition T11, Cross armchair, Goya service



Tokio sofa composition T11, Cross armchair, Sigmund small table, Goya service



Tokio sofa composition T10, Leafo armchair, Goya small table, Arcolor small table, Island small table



Tokio sofa composition T10, Leafo armchair, Goya small table, Arcolor small table



Tokio sofa composition T09, Island small table





Tokio sofa composition T08, Delfino armchair, Goya small table

INFINITY

by Claesson
Koivisto
Rune

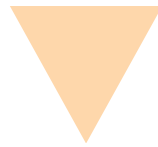

The mathematical symbol of eternity is a figure that resembles a horizontal figure 8. The analogy is of course that if you follow the line, it will take you eternity to arrive at its end.

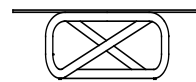

Infinity *small table*



Infinity *small table*,
Elettra *armchair*,
Ben Ben *sofa*



TELLIN

by Luca
Nichtetto



Tellin armchair has the elegant appearance of a welcoming open seashell. Two “valves” meet and merge by overlapping so to compose the seat and backrest, an encounter that marks the juxtaposition of the different colours of the cover.

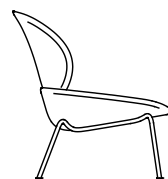

Tellin *armchair*, Marengo *sofa*,
Infinity *small table*



Tellin armchair,
Match bookcase



TABLET

by Claesson
Koivisto
Rune

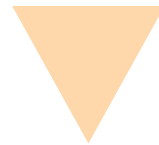

The inspiration for their form comes from ornamental pendants fashioned and worn by the Maori peoples of New Zealand. Thanks to the table structure, the table tops appear to float above the legs, giving to Tablet small tables an elemental, sculptural quality.

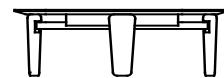



Tablet *small table*

Tablet small table, Tokio sofa, Alba bookcase



RENDEZ - VOUS

by Mauro Lipparini



Serenity, simplicity, materiality, modularity are some of the key words of Rendez-Vous.

Its overall formal rigor is accompanied by the exuberance of the inner softness, as trying to hug and hold the body and the pleasure of comfort.

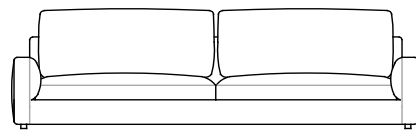

Rendez-Vous sofa,
Giulietta armchair,
Tablet small table



Rendez-Vous sofa,
Tablet small table,
Giulietta armchair





Rendez-Vous sofa composition R15, Hall armchair, Doge pouf, Tablet small table

Rendez-Vous sofa composition R13, Tablet small table, Capilano small table, Diva screen



Rendez-Vous sofa composition R13, Capilano small table, Doge pouf



Capilano *small table*,
Lee sofa



Capilano small table , Ben Ben sofa



RUBYCON

by Claesson
Koivisto
Rune

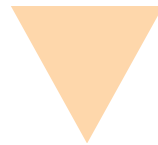

Minimal form, maximum variety of expression.

Rubycon concept allows the creation of unique, free-standing cabinets, through customisation, giving also the possibility to have decorative and lacquered pieces, in matching or contrasting colours, depending where they are placed.

Rubycon concept uses the repetition of a single storage 'cube' to create a horizontal column in five different lengths.

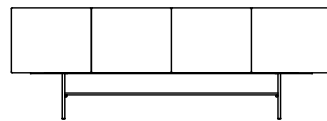

Rubycon sideboard

Rubycon sideboard



CLAUDINE

by Claesson
Koivisto
Rune



A classic typology served on a tender tray, the sofa is flexible in configuration – high, low, small, big, two-seater, three-seater, pouf - always floating on an upturned edge, reminiscent of the dress collar known in French as "col Claudine".

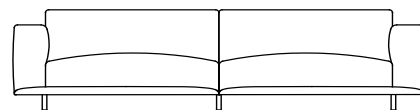

Claudine sofa, Island small table



Claudine sofa, Cradle small table, Pecorelle armchair

Claudine sofa
Diva screen
Tablet small table



SERENA & DOGE

by Luca Nichetto



Arflex is a pillar of the Italian tradition, thanks to its masterpieces, that have contributed to the creation of home space lifestyle, typical of the Italian design: among these the armchairs, which exalt the skilful use of wood and fabric upholstery. Starting from these elements, Luca Nichetto's search has gone further, arriving to the model of the Venetian bergère and of its ottoman.

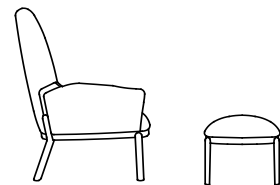

Serena armchair, Doge pouf



Serena armchair, Doge pouf

SOFT BEAT

by Claesson
Koivisto
Rune



Slow waves, rolling hills, soothing pulse: kind, soft, iconic – Soft Beat.

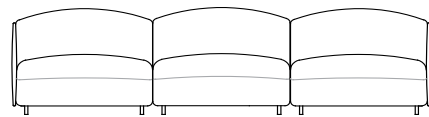

Soft Beat sofa composition SB03, **Arcolor** small table



Soft Beat sofa, Match small table, Elettra armchair

Soft Beat sofa composition SB07, Soft Beat armchair, Goya small table



K2

by Carlo
Colombo



Carlo Colombo designed a seating system of large format and particular comfort.

Inspired by the high peaks, but characterised by great formal elegance, which adapts with style and elegance to all spaces.

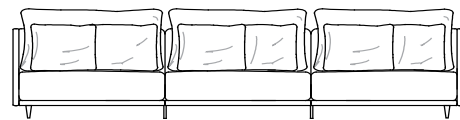

K2 sofa, Island small table



K2 sofa composition K02, Island small table, Goya small table, Giulietta armchair, Delfino pouf

K2 sofa composition K03,
Cradle small table



GIULIETTA

by B.B.P.R.



The 50-years design was born at a time when Italy wanted redemption after the war. The design architects (not yet called designer) and the companies created products to inspire hope and good humour to people. Belgiojoso, Peressutti and Rogers of B.B.P.R. office designed the armchair Giulietta, with all the characteristics of arflex production: depth study of the line and absolute comfort, without forgetting the elegance.

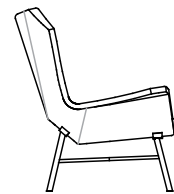

Giulietta armchair, Tablet small table

Giulietta armchair,
Bonsai small table



FRAME

by Carlo
Colombo



Seat system with a comfortable line, where its structure can be enriched by the manual weave of the cowhide, to give to the sofa an elegant scene.

Frame was designed to furnish living and hospitality spaces with elegance and style.

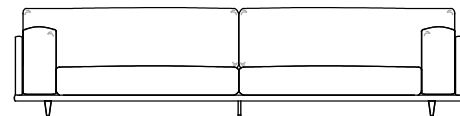

Frame sofa,
Penta pouf





Frame sofa composition F10, Gloria armchair, Goya small table, Sigmund small table



Frame sofa composition F10, Goya small table, Sigmund small table

Faubourg sofa



KATRIN

by Carlo
Colombo



The continuous research of elegance and simplicity brought the architect Carlo Colombo to realize the armchair Katrin, thought as a body to be worn with an elegant and luxury fur.

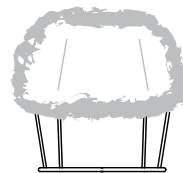



Katrin *armchair*



arflex
collection

technical drawings





9000

Poltrona
Armchair

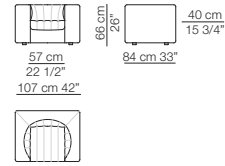

Divani
Sofas

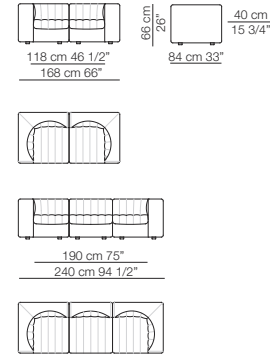

Elemento con 1 bracciolo
Unit with 1 armrest

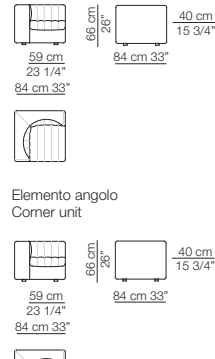

Elemento senza braccioli
Unit without armrests

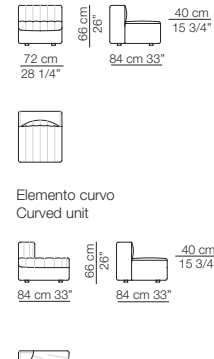

Pouf

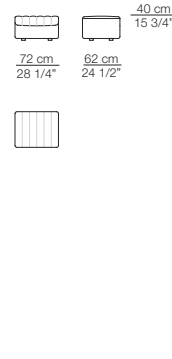

Elemento angolo
Corner unit

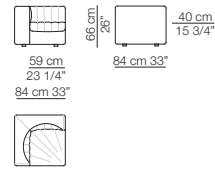

Elemento curvo
Curved unit

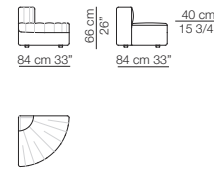

Composizioni
Compositions

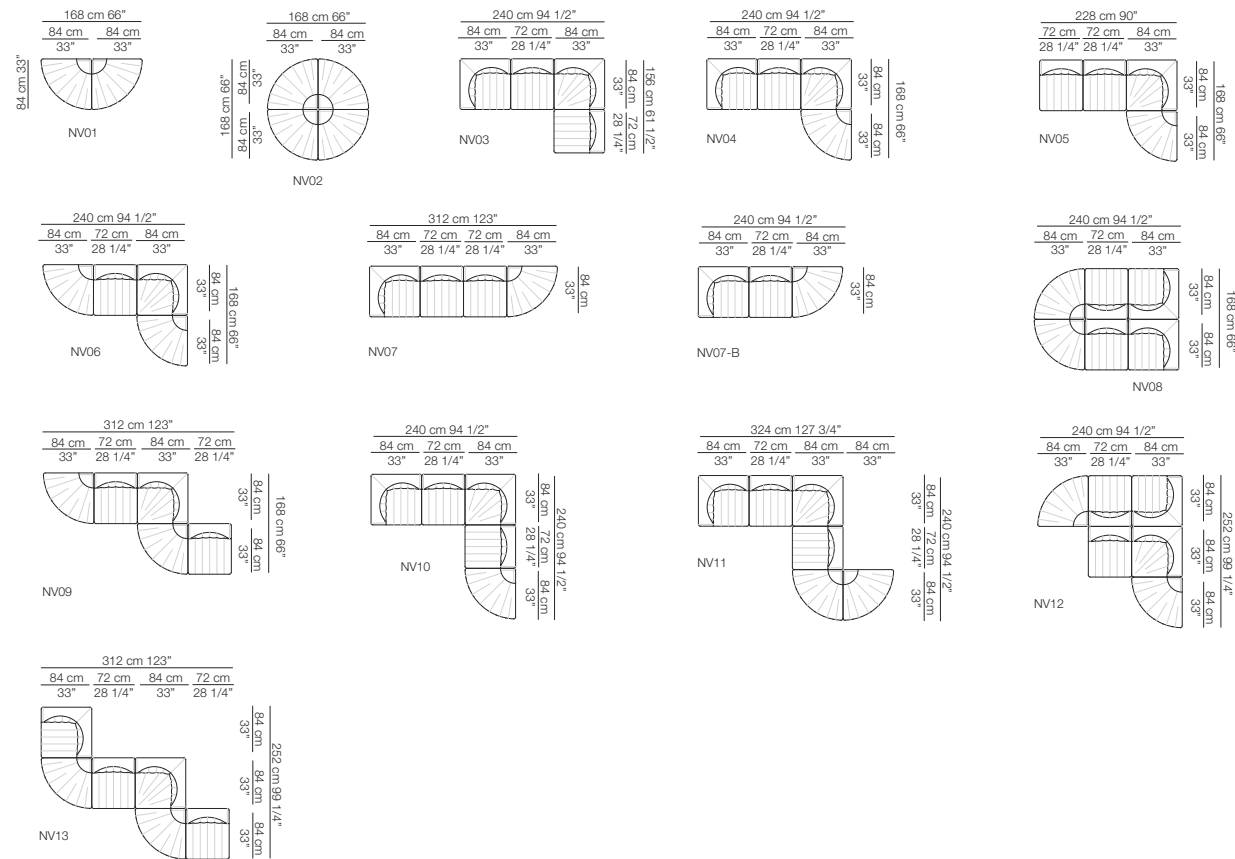

Arcolor

Divani
Sofas

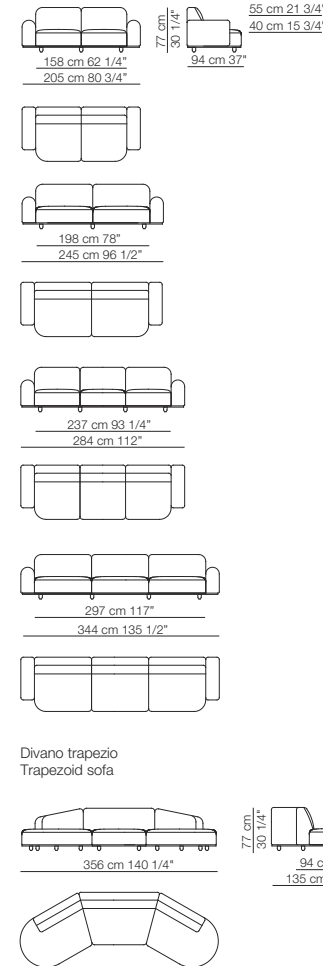

Elementi con 1 bracciolo
Units with 1 armrest

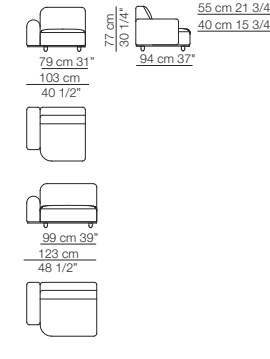

Elementi senza braccioli
Units without armrests

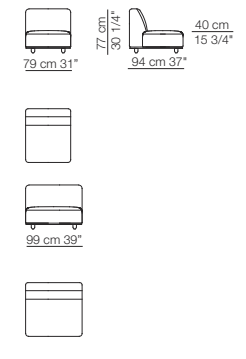

Pouf

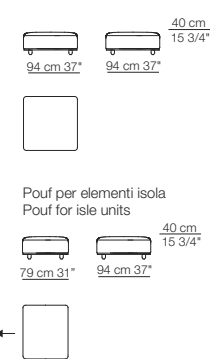

Pouf per elementi isola
Pouf for isle units

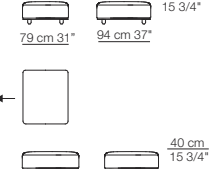

Elemento angolo
Corner unit

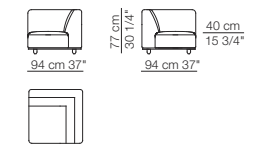

Tavolino angolare
Corner small table

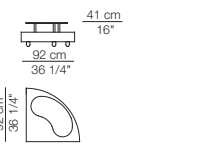

Elementi isola trapezio
Trapezoid isle units

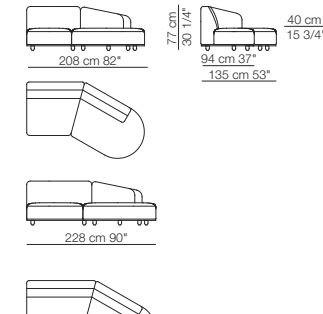

Divano trapezio
Trapezoid sofa

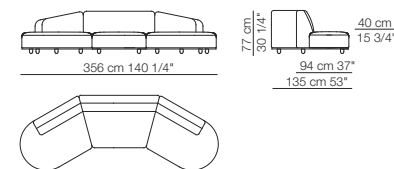

Composizioni
Compositions

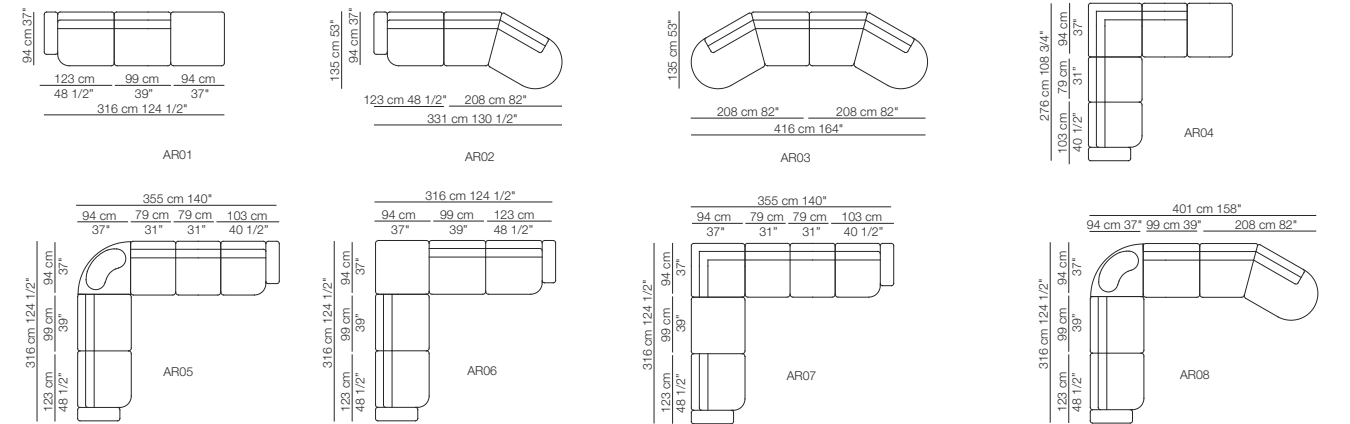



Bel air

Divani
Sofas

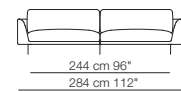
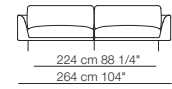
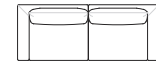
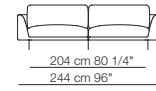
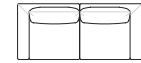
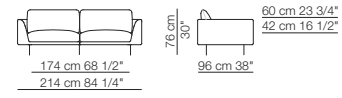

Elemento isola trapezio senza braccioli
Trapezoid isle unit without armrests

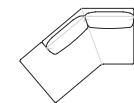
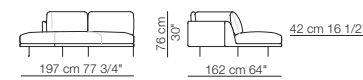

Elemento isola trapezio senza braccioli con piano
Trapezoid isle unit without armrests with top

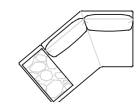
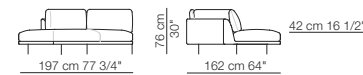

Elementi con 1 bracciolo
Units with 1 armrest

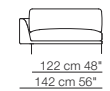
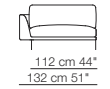
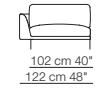
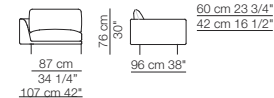

Elemento trapezio con 1 bracciolo
Trapezoid unit with 1 armrest

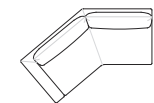
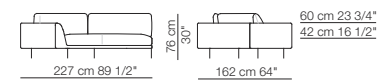

Tavolino
Small table

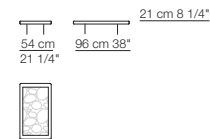

Elementi senza braccioli
Units without armrests

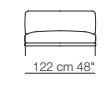
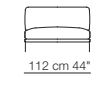
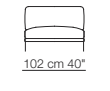
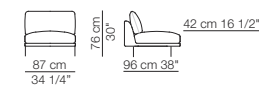

Elementi angolo
Corner units

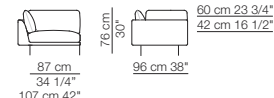

Pouf



Composizioni
Compositions

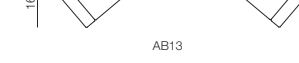
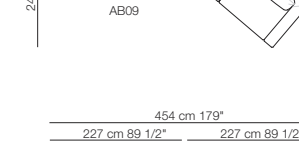
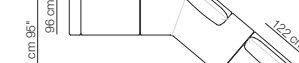
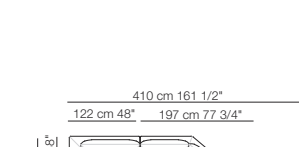
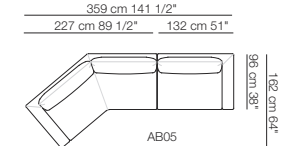
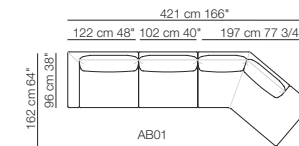

Banah

Dormeuse

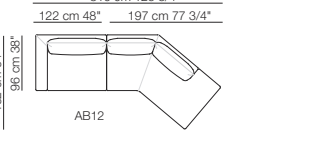
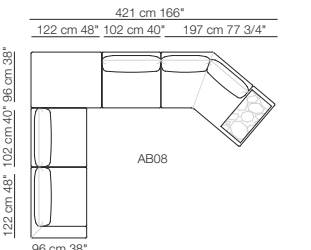
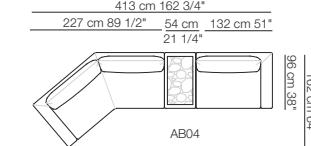
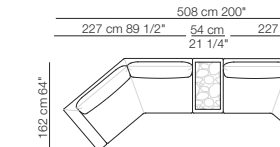
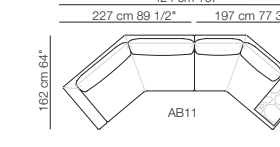
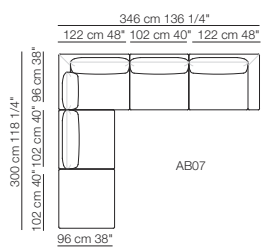
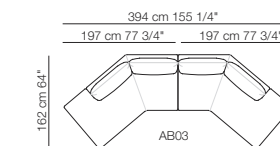
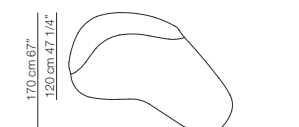
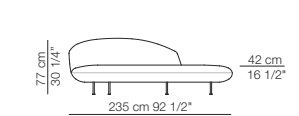

Divani / Sofas



Ben Ben

Divano
Sofa

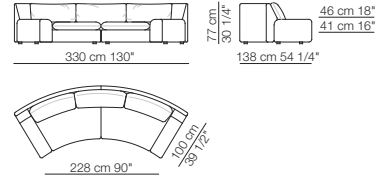

Elementi con 1 bracciolo
Units with 1 armrest

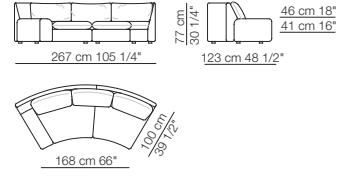

Elemento senza braccioli
Unit without armrests

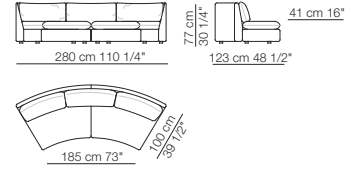

Composizioni
Compositions

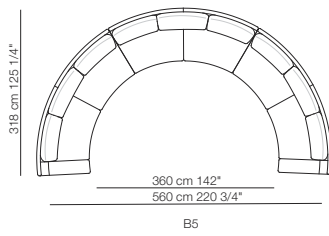
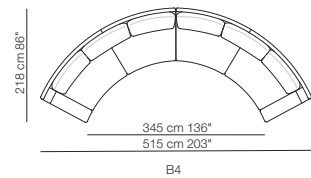
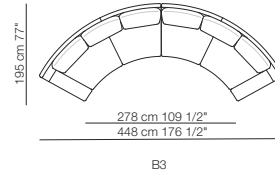

Bonsai

Divano con base in legno
Sofa with wooden base

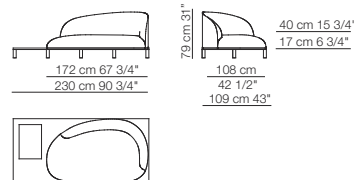

Divano con base in metallo
Sofa with metal base

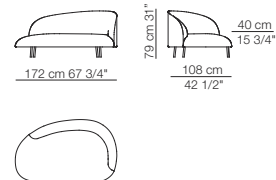

Tavolino
Small table

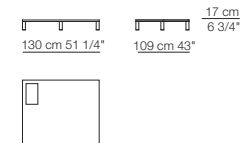

Divano con base in metallo e gonnella
Sofa with metal base and skirt

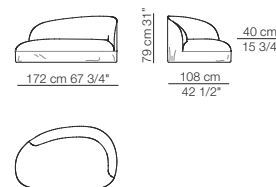

Divani / Sofas



Claudine M

Divani
Sofas

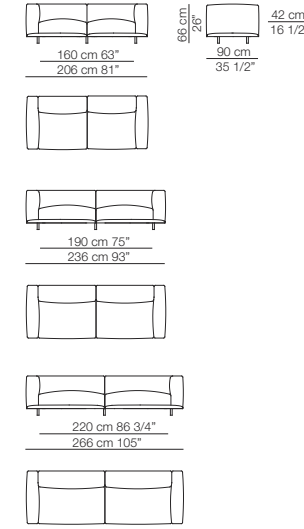

Elementi con 1 bracciolo
Units with 1 armrest

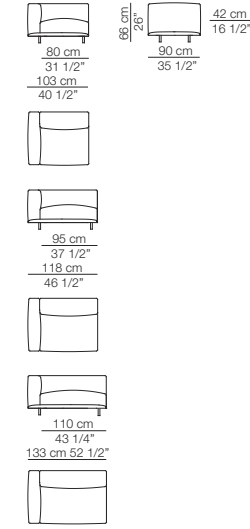

Elementi senza braccioli
Units without armrests

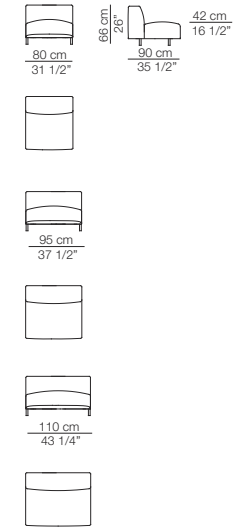

Chaise longue con 1 bracciolo
Chaise longue with 1 armrest

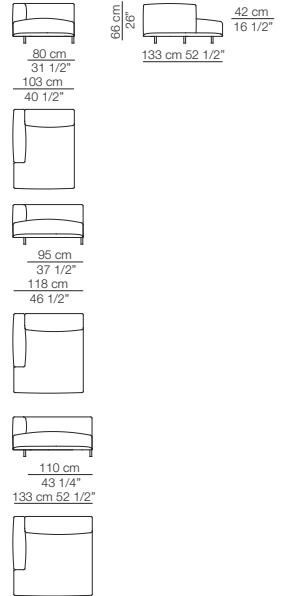

Elemento angolo
Corner unit

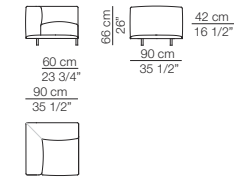

Pouf

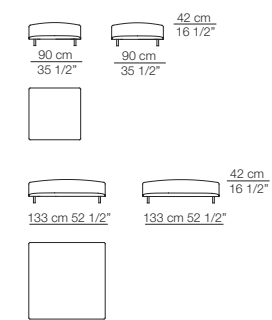



Claudine L

Divani
Sofas

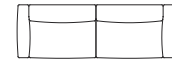
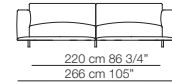
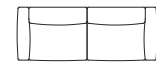
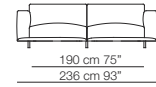
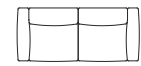
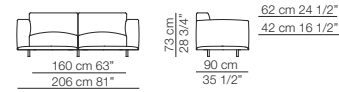

Elemento angolo
Corner unit

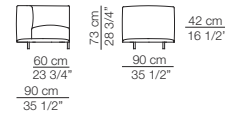

Claudine M-L

Composizioni
Compositions

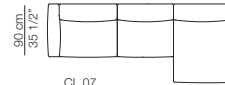
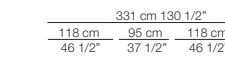
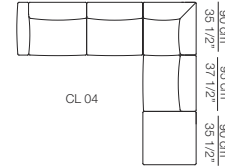
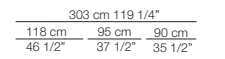

Elementi con 1 bracciolo
Units with 1 armrest

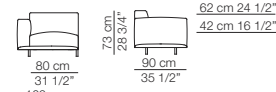

Pouf

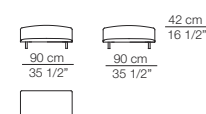

Elementi senza braccioli
Units without armrests

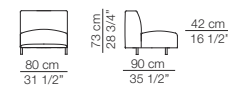

Chaise longue con 1 bracciolo
Chaise longue with 1 armrest

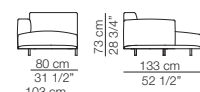

Cousy

Poltrona
Armchair

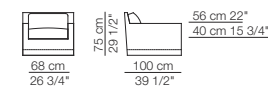

Chaise longue con 2 braccioli
Chaise longue with 2 armrests

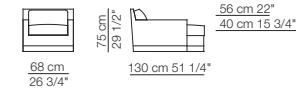

Pouf

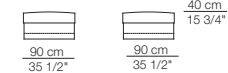

Cradle

Divano
Sofa

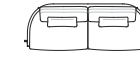

Service



Faubourg

Divani
Sofas

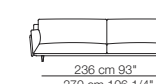
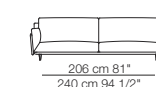
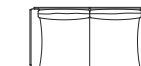
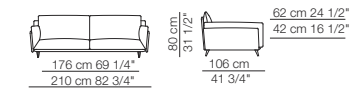

Cuscini Faubourg
Faubourg cushions

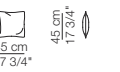

Deep Cradle

Divano
Sofa

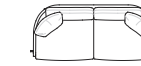



Frame

Divani
Sofas

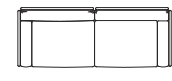
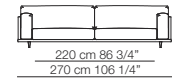
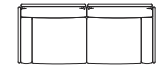
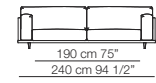
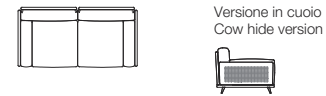
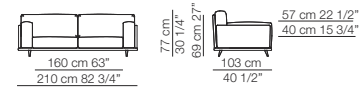

Elementi angolo
Corner units

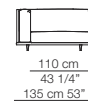
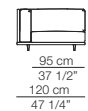
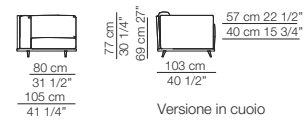

Elementi con 1 bracciolo
Units with 1 armrest

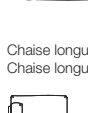
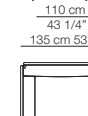
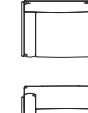
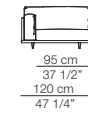
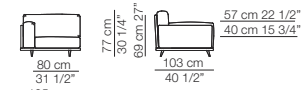

Chaise longue con 1 bracciolo
Chaise longue with 1 armrest

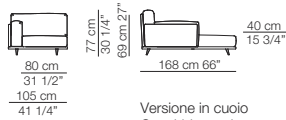

Elementi senza braccioli
Units without armrests

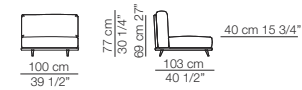

Pouf

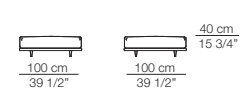

Composizioni
Compositions

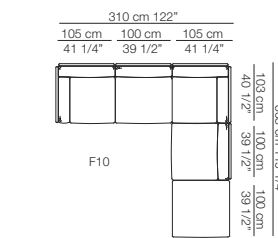
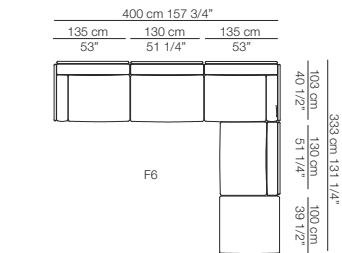
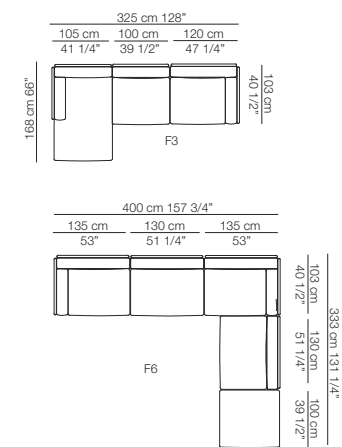
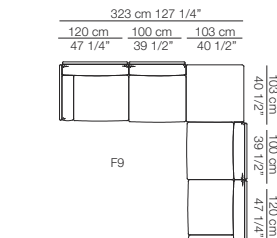
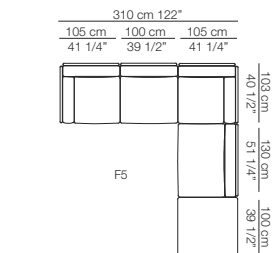
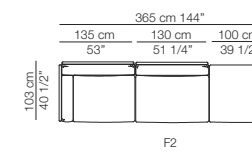
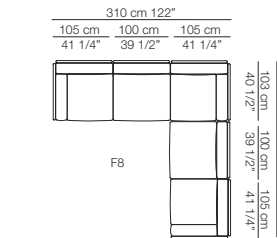
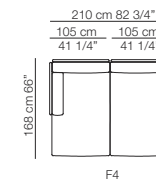
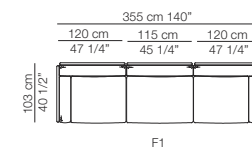

Hall
Divano
Sofa

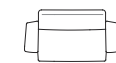
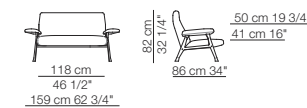

Hug love seat
Divano con schienale basso
Sofa with low backrest

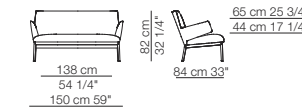

Hug love seat
Divano con schienale alto
Sofa with high backrest

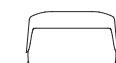
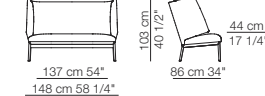

Pecorelle
Divano
Sofa

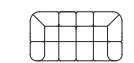
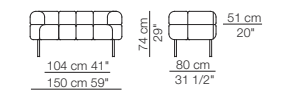



Hollywood

Divani
Sofas

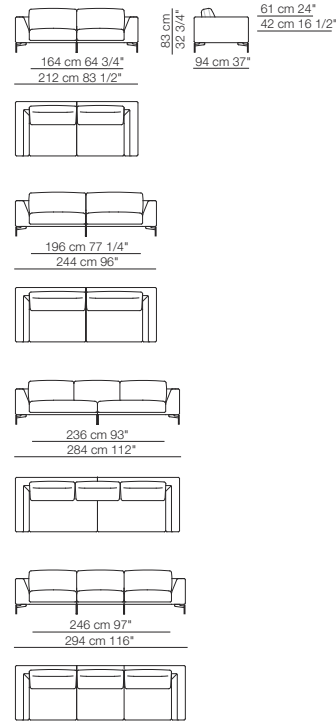

Elementi isola con angolo
Isle units with corner unit

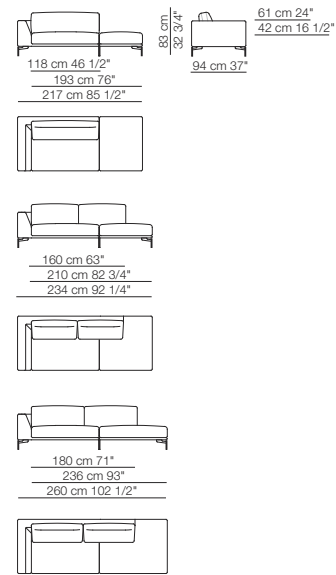

Elementi con 1 bracciolo
Units with 1 armrest

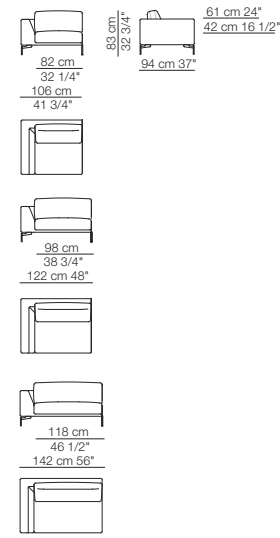

Elementi senza braccioli
Units without armrests

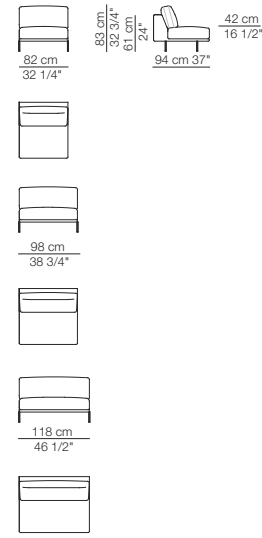

Elementi isola senza braccioli
Isle units without armrests

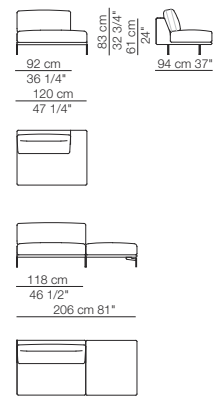

Elementi con 1 bracciolo P.120
Units with 1 armrest D.120

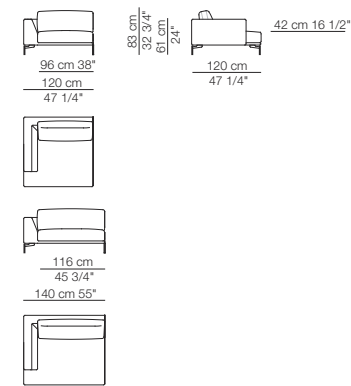

Elemento senza braccioli P.120
Unit without armrests D.120

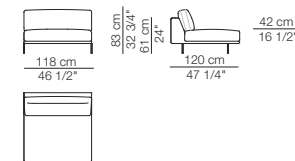

Chaise longue con 1 bracciolo
Chaise longue with 1 armrest

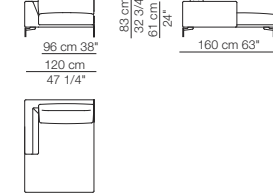

Pouf

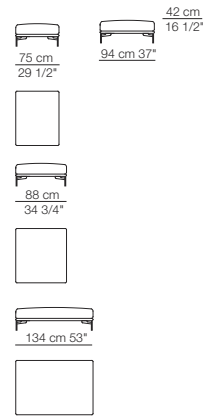

Cuscino angolo
Corner cushion

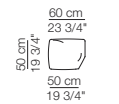

Composizioni
Compositions

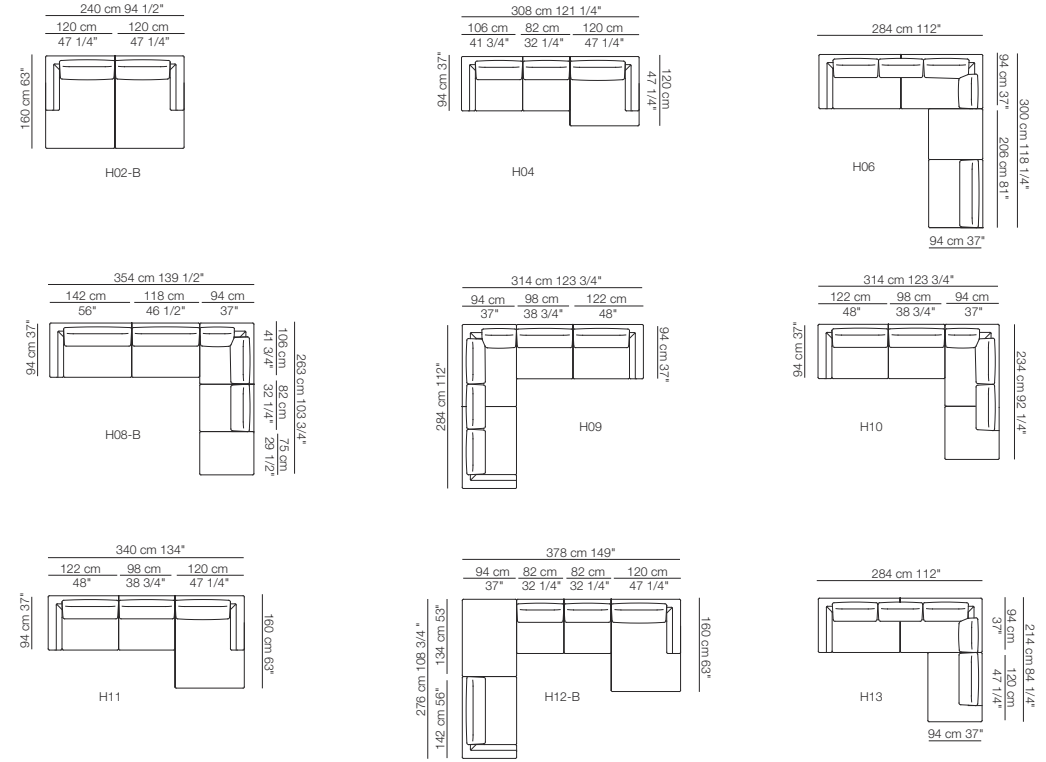

K2

Divani
Sofas

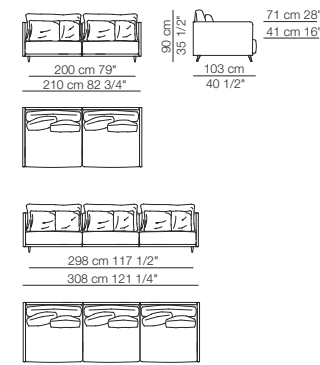

Elemento con 1 bracciolo
Unit with 1 armrest

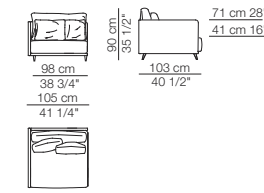

Elemento senza braccioli
Unit without armrests

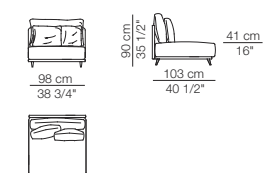

Elemento angolo
Corner unit

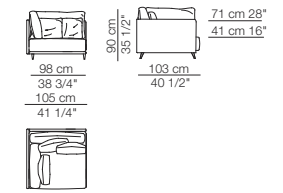

Pouf

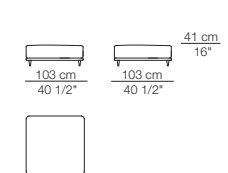

Cuscini
Cushions

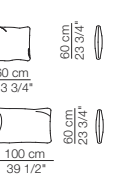

Composizioni
Compositions

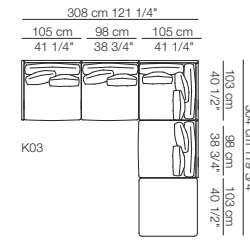
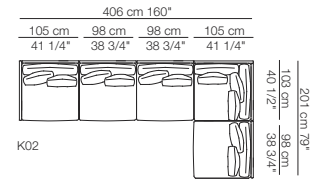
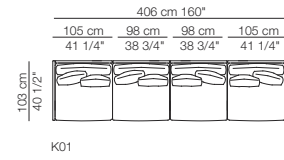

Lee
Divani
Sofas

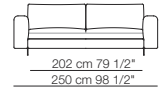
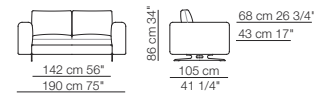

Elementi con 1 bracciolo
Units with 1 armrest

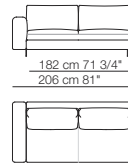
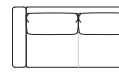
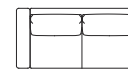
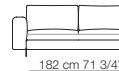
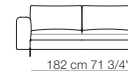
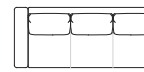
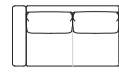
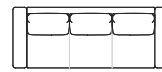
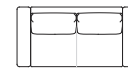
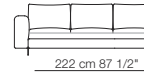
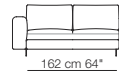
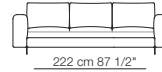
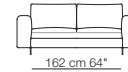
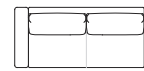
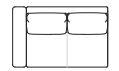
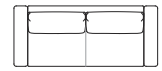
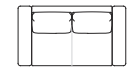
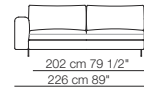
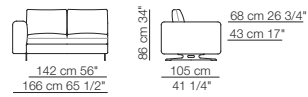

Elementi senza braccioli
Units without armrests

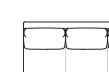
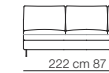
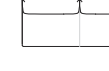
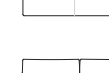
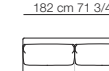
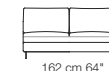
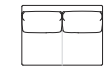
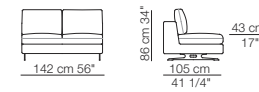

Elementi angolo con 1 bracciolo
Corner units with 1 armrest

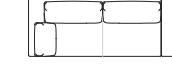
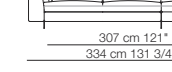
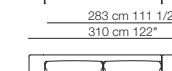
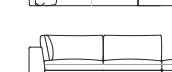
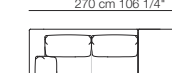
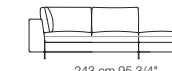
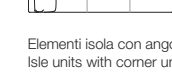
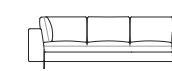
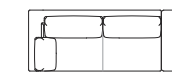
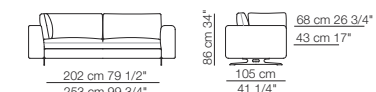

Chaise longue con 1 bracciolo
Chaise longue with 1 armrest

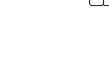
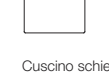
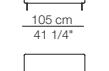
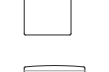
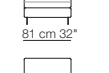
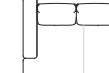
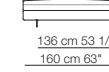
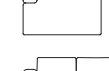
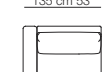
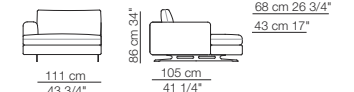

Composizioni
Compositions

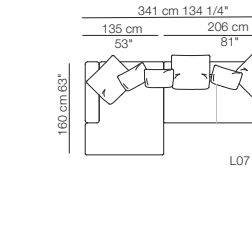
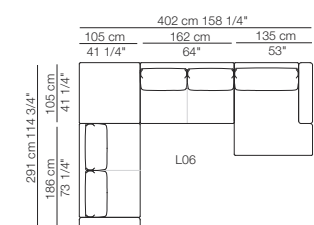
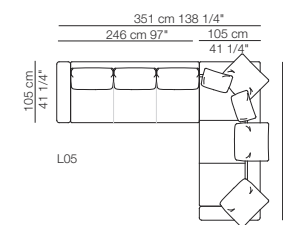
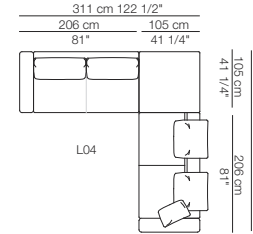
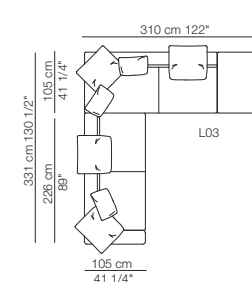
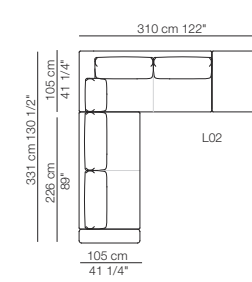
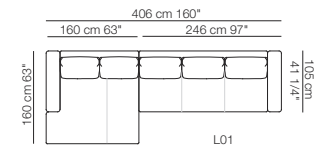

Divani / Sofas

Sofa with low standard armrests - version "L"



Sofa with high armrests - version "H"



Low land

Divani Sofas

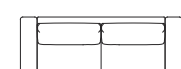
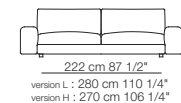
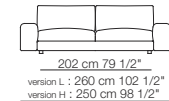
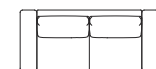
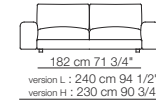
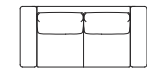
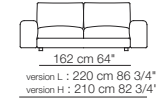
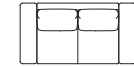
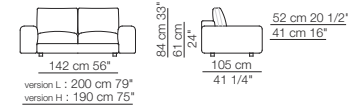

Elementi con 1 bracciolo Units with 1 armrest

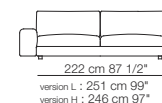
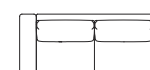
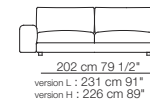
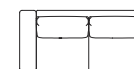
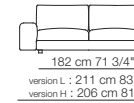
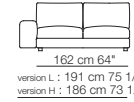
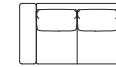
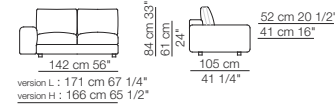

Elementi senza braccioli Units without armrests

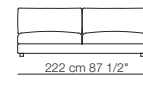
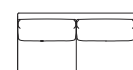
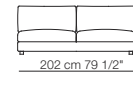
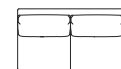
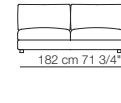
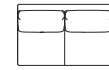
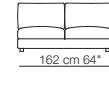
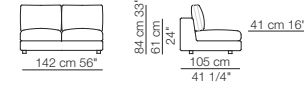

Divani / Sofas

Elementi angolo con 1 bracciolo Corner units with 1 armrest

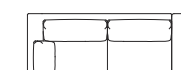
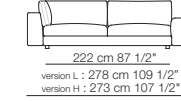
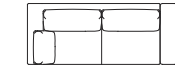
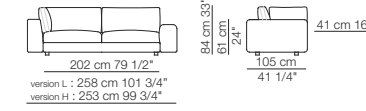

Elementi isola con angolo Isle units with corner

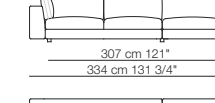
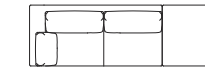
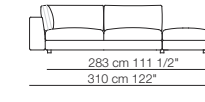
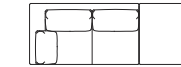
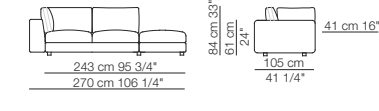

Pouf

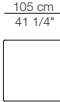
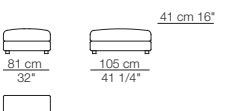



Marechiaro

Poltrone con braccioli bassi
Armchairs with low armrests

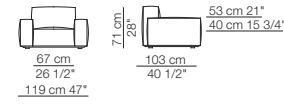

Poltrona con braccioli alti
Armchair with high armrests

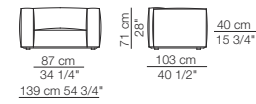

Elementi senza braccioli
Units without armrests

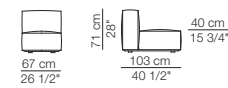

Divani
Sofas

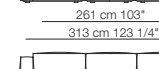
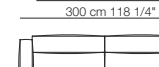
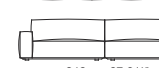
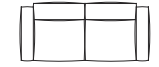
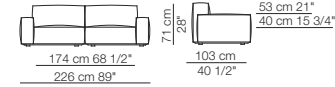

Elementi senza braccioli con schienale basso
Units without armrests with low backrest

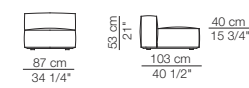

Elementi con 1 bracciolo
Units with 1 armrest

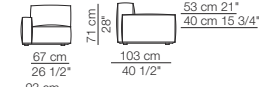

Elementi angolo
Corner units

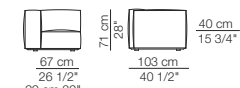

Elementi con 1 bracciolo alto
Units with 1 high armrest

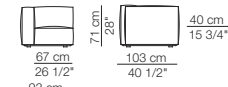

Elementi isola
Isle units

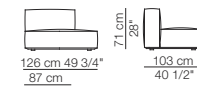

Elementi con 1 bracciolo P.124
Units with 1 armrest D.124

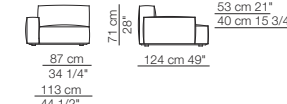

Elementi angolo P.124
Corner units D.124

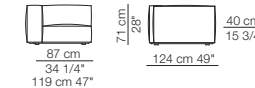

Elementi con 1 bracciolo lungo P.124
Units with 1 long armrest D.124

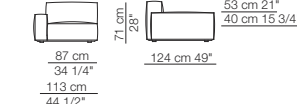

Elementi senza braccioli P.124
Units without armrests D.124

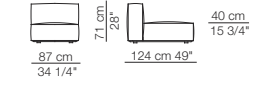

Elementi senza braccioli con schienale basso
Units without armrests with low backrest

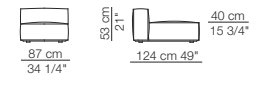

Composizioni
Compositions

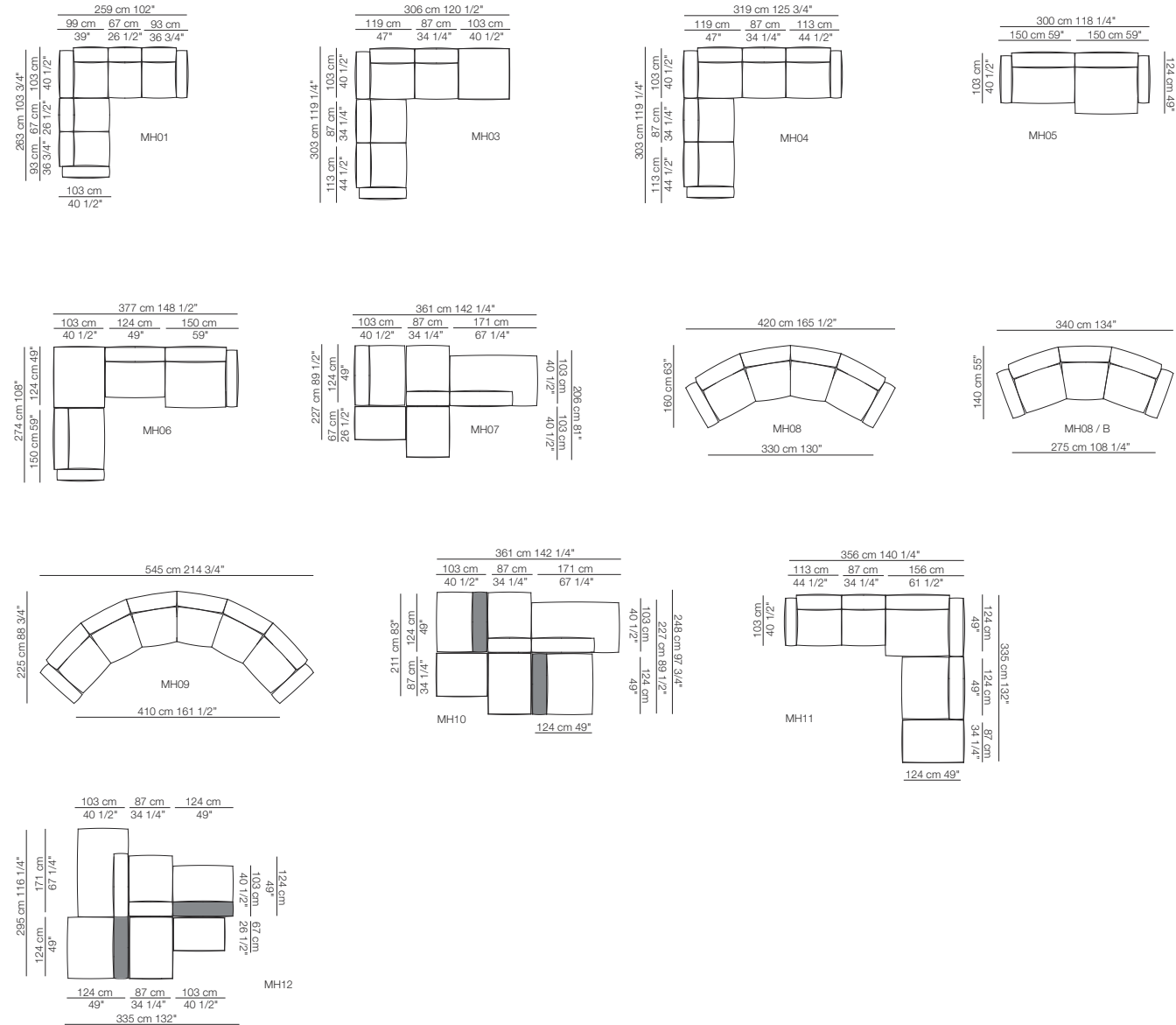

Marenco 2018

Poltrona
Armchair

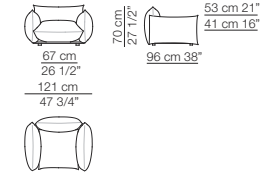

Elementi senza braccioli
Units without armrests

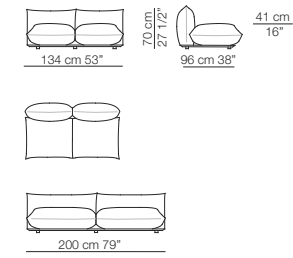

Elementi angolo con 1 bracciolo
Corner units with 1 armrest

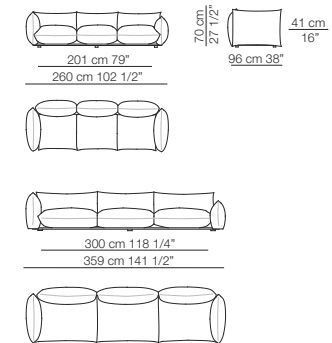

Composizioni
Compositions

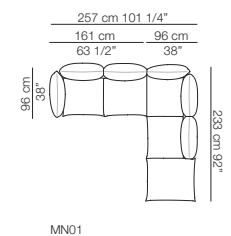

MN01

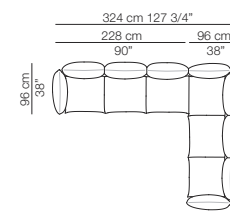

MN02

Divani
Sofas

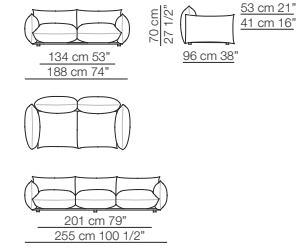

Elementi isola con angolo
Isle units with corner unit

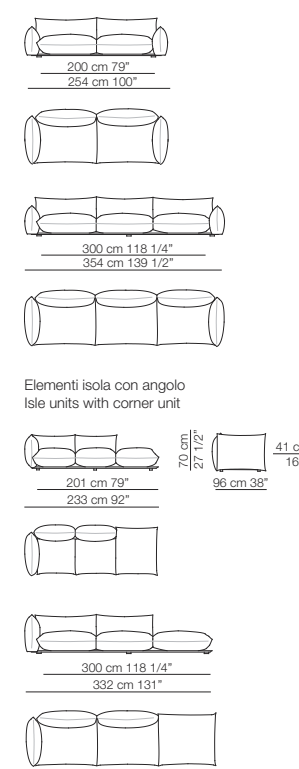

MN03

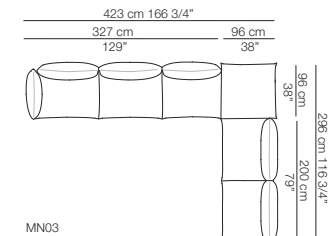

Elementi con 1 bracciolo
Units with 1 armrest

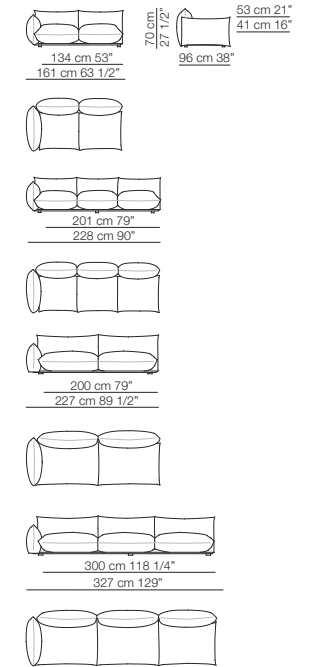

Pouf

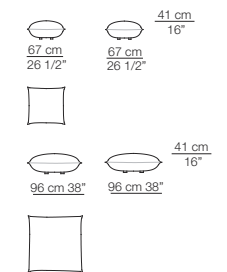



Naviglio

Divani
Sofas

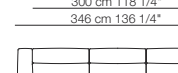
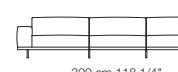
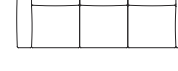
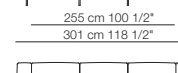
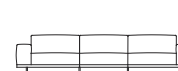
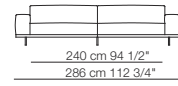
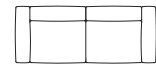
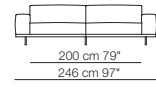
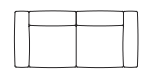
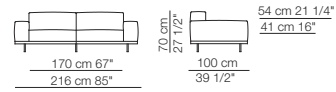

Composizioni
Compositions

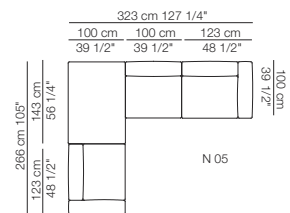
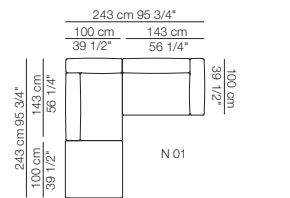

Elementi con 1 bracciolo
Units with 1 armrest

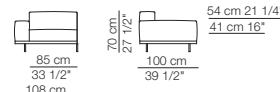

Pouf

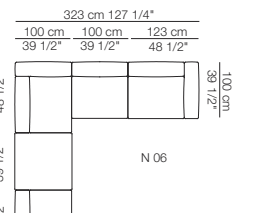
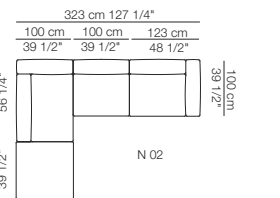

Elementi senza braccioli
Units without armrests

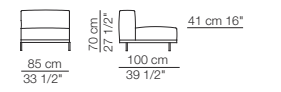

Elementi angolo
Corner units

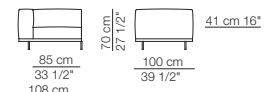

Rendez-vous D.95

Divani
Sofas

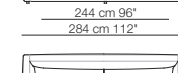
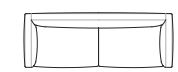
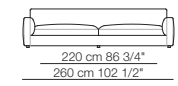
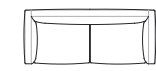
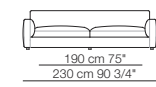
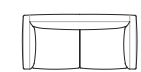
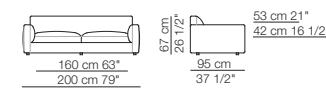

Elementi angolo / Elementi con 1 bracciolo alto
Corner units / Units with 1 high armrest

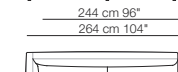
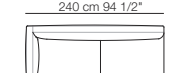
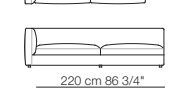
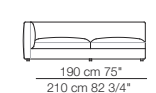
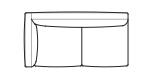
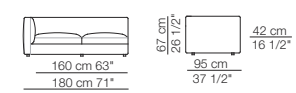

Divani con braccioli alti
Sofas with high armrests

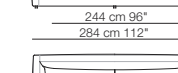
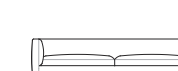
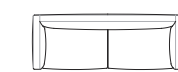
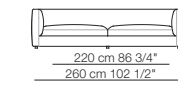
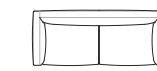
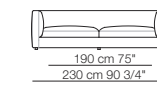
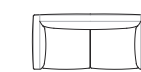
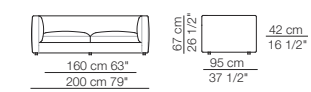

Elementi angolo con 1 bracciolo
Corner units with 1 armrest

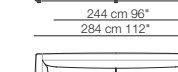
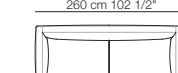
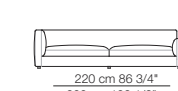
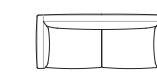
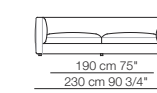
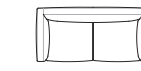
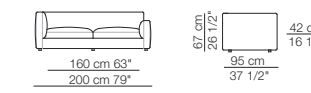



Elementi senza braccioli
Units without armrests



Chaise longue con 1 bracciolo basso
Chaise longue with 1 low armrest

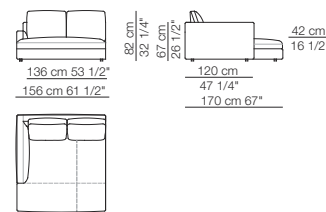

Elementi isola senza braccioli
Isle units without armrests

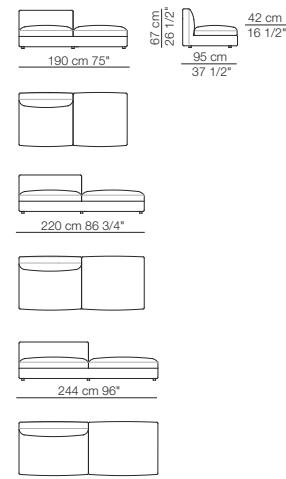

Pouf

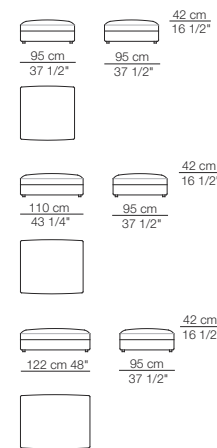

Elementi isola con angolo
Isle units with corner unit

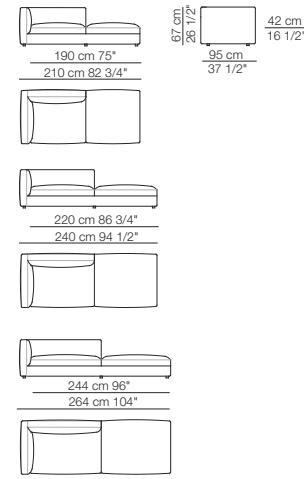

Cuscini schienale opzionali
Optional backrest cushions

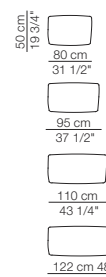

Cuscini schienale angolo
Backrest corner cushions



Rendez-vous D.120

Divani
Sofas

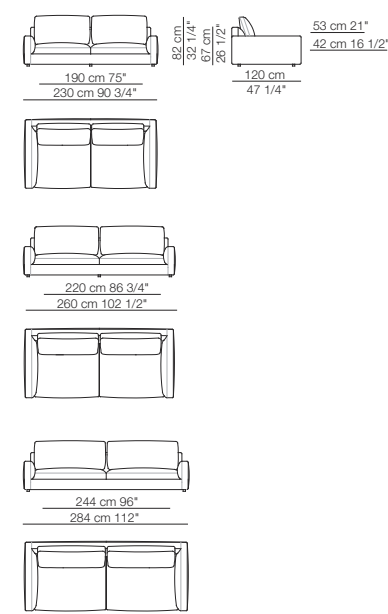

Elementi con 1 bracciolo
Units with 1 armrest

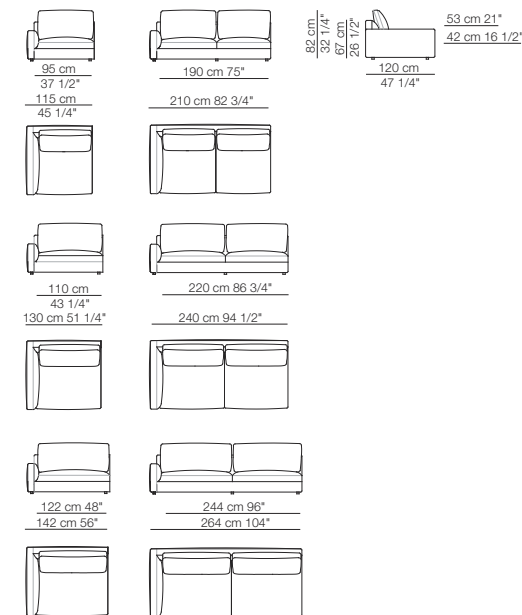

Divani con braccioli alti
Sofas with high armrests

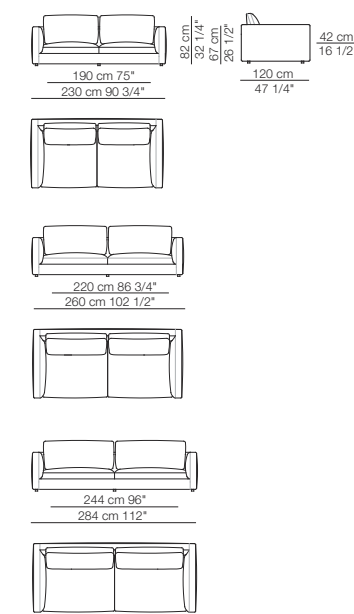

Elementi angolo con 1 bracciolo
Corner units with 1 armrest

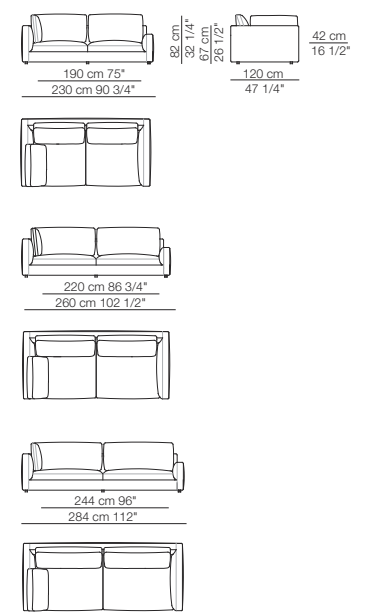

Elementi angolo / Elementi con 1 bracciolo alto
Corner units / Units with 1 high armrest

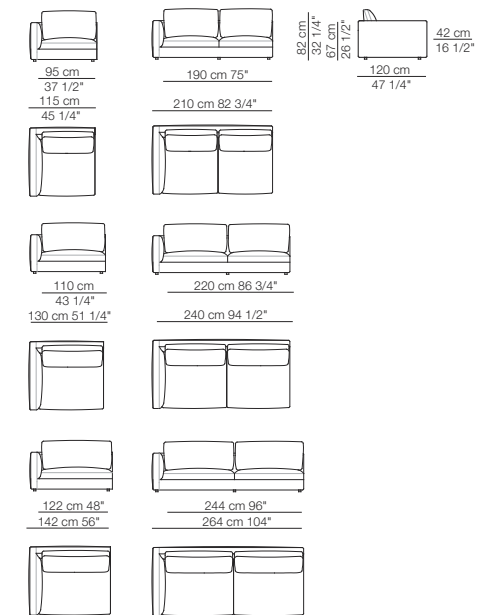

Elementi senza braccioli
Units without armrests

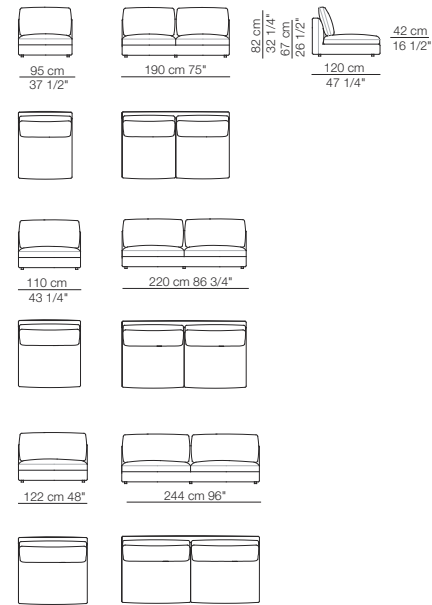

Chaise longue con 1 bracciolo basso
Chaise longue with 1 low armrest

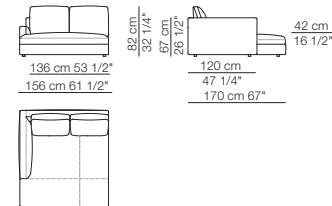

Elementi isola senza braccioli
Isle units without armrests

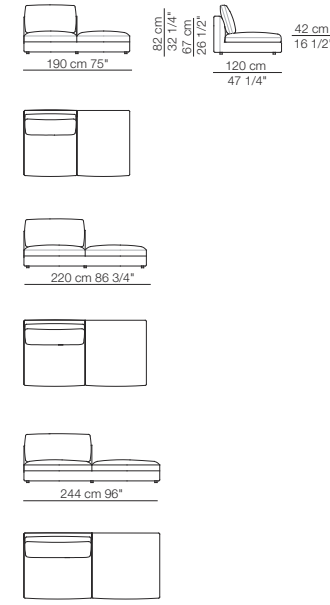

Pouf

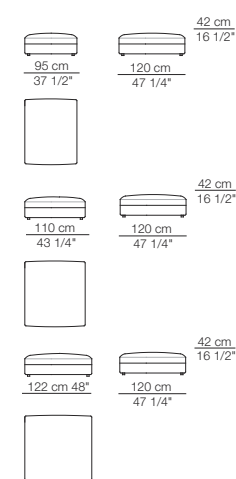

Elementi isola con angolo
Isle units with corner unit

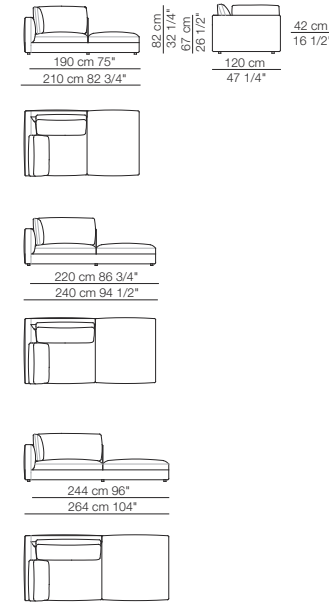

Cuscino schienale per angolo
Backrest cushion for corner unit



Rendez-vous D.95 - 120

Composizioni
Compositions

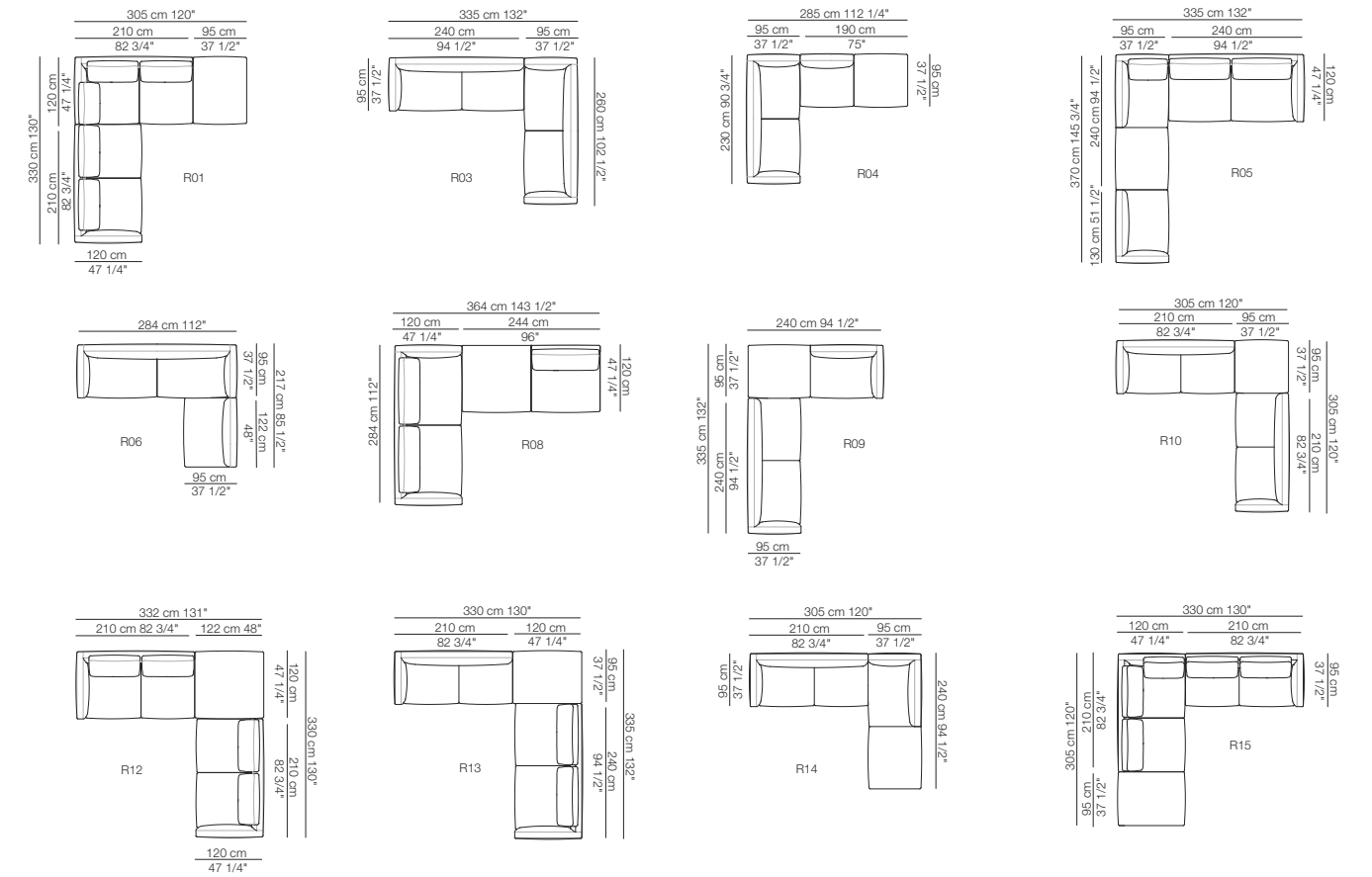



Soft Beat

Poltrona
Armchair

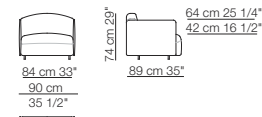

Divano
Sofa

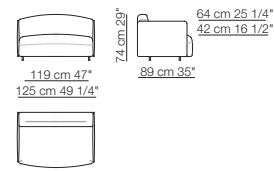

Elementi con 1 bracciolo
Units with 1 armrest

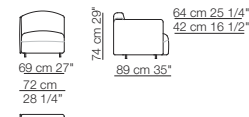

Elementi senza braccioli
Units without armrests

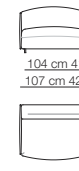
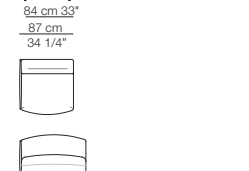

Elementi senza braccioli
Units without armrests

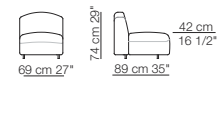

Chaise longue con 1 bracciolo
Chaise longue with 1 armrest

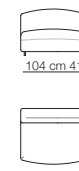
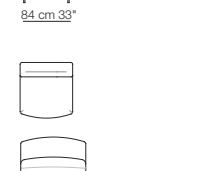

Chaise longue con 1 bracciolo
Chaise longue with 1 armrest

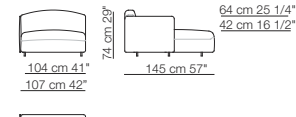

Chaise longue senza braccioli
Chaise longue without armrests

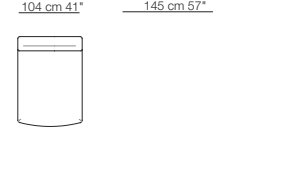
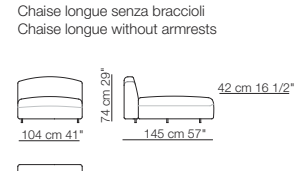

**Composizioni
Compositions**

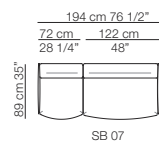
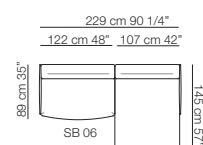
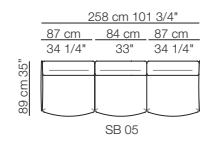
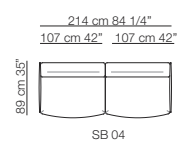
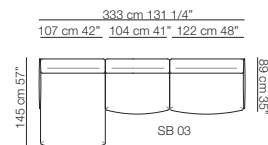
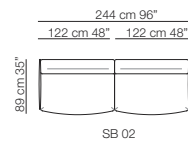
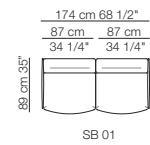

Strips

Divani
Sofas

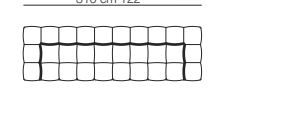
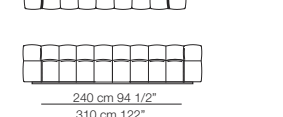
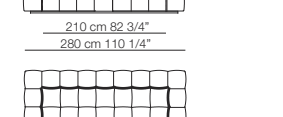
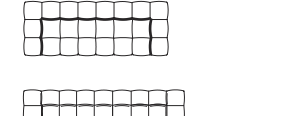
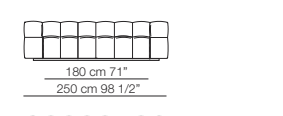
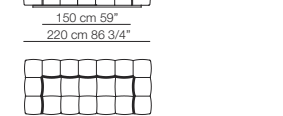
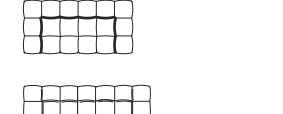
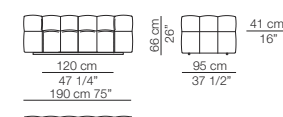

Elementi con 1 bracciolo
Units with 1 armrest

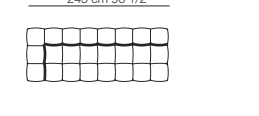
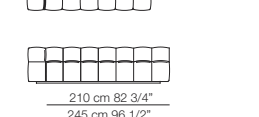
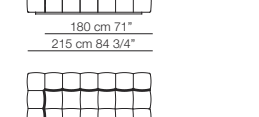
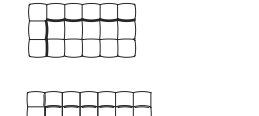
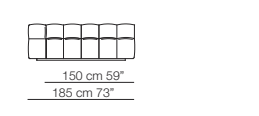
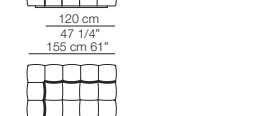
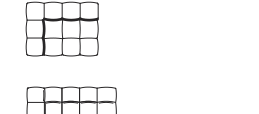
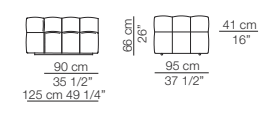

Elementi senza braccioli
Units without 1 armrests

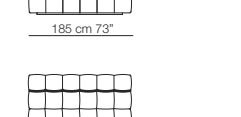
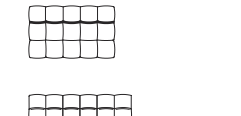
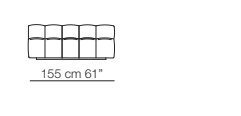
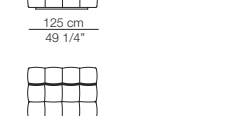
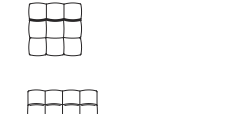
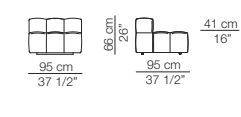

Divani P.125
Sofas D.125

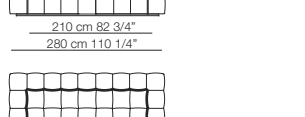
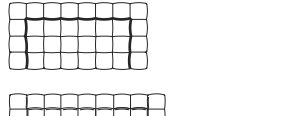
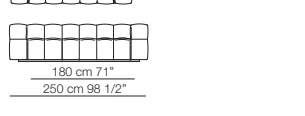
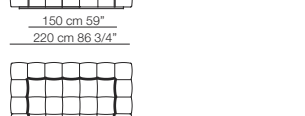
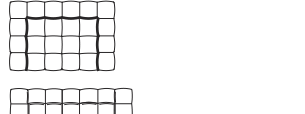
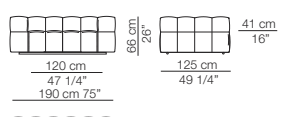



Divani con braccioli corti P.125
Sofas with short armrests D.125

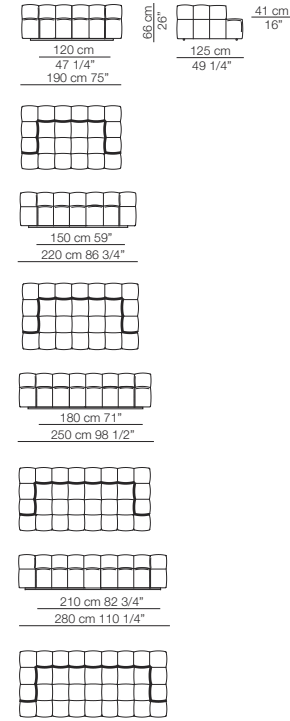

Elementi con 1 bracciolo P.125
Units with 1 armrest D.125

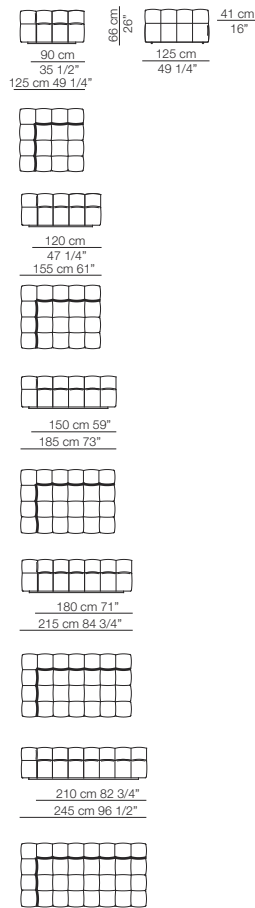

Elementi con 1 bracciolo corto P.125
Units with 1 short armrest D.125

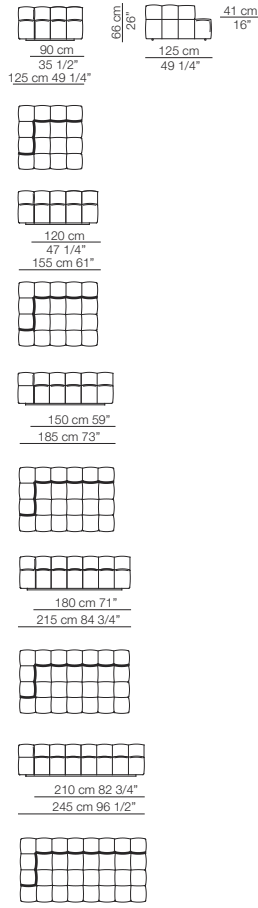

Elementi senza braccioli P.125
Units without armrests D.125

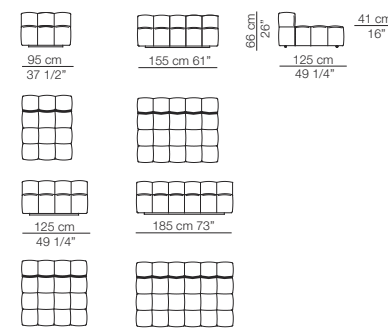

Pouf

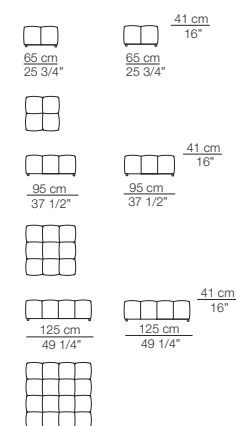

Cuscini arredo Soft
Soft loose cushions



Composizioni
Compositions

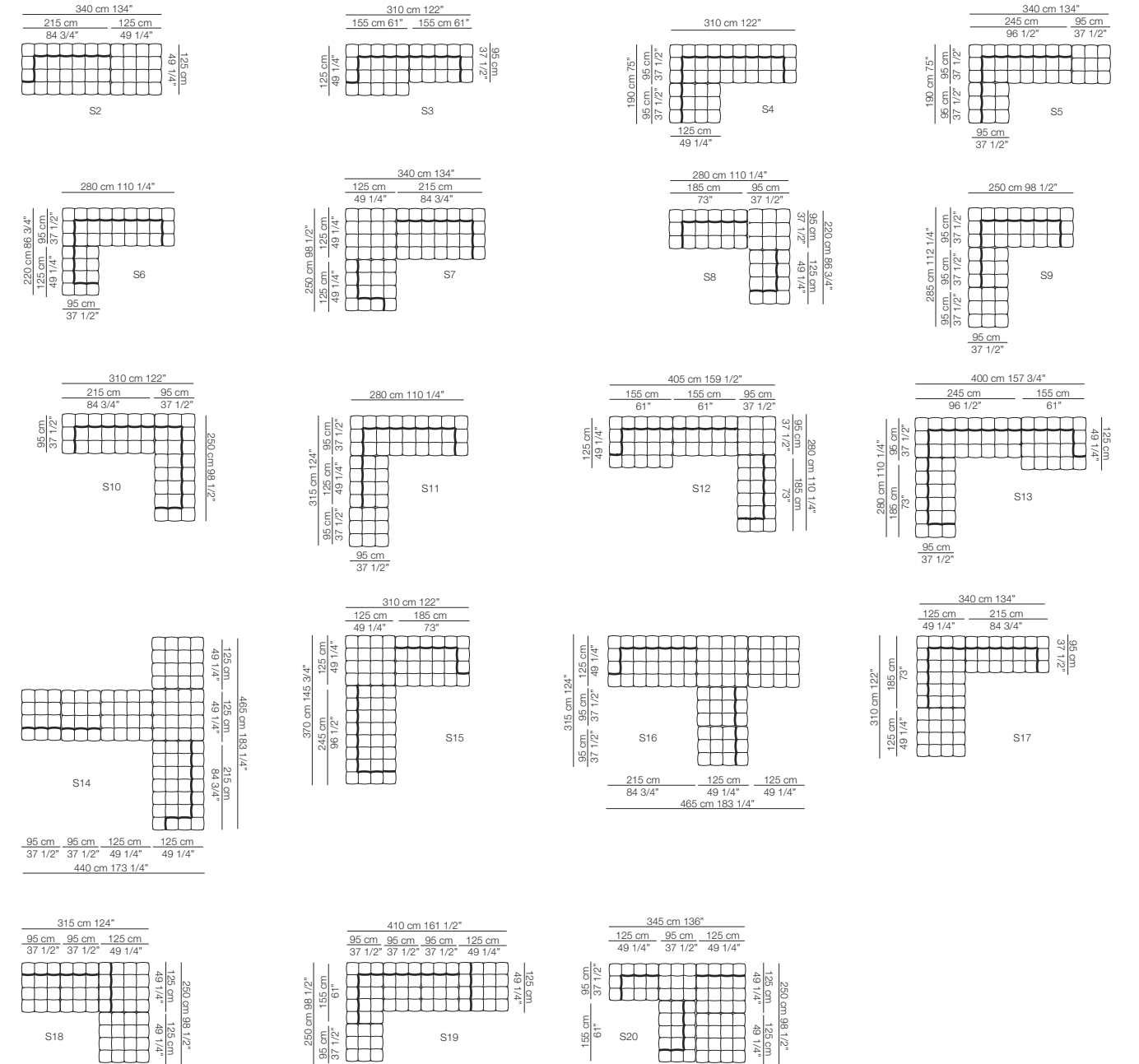



Tokio

Divani Sofas

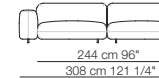
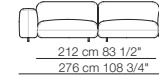
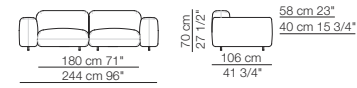

Elementi senza braccioli P.106
Units without armrests D.106

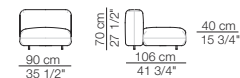

Elementi con 1 bracciolo P.106
Units with 1 armrest D.106

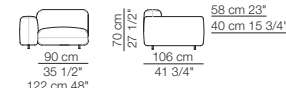

Elementi senza braccioli P.122
Units without armrests D.122

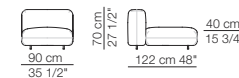

Elementi con 1 bracciolo P.122
Units with 1 armrest D.122

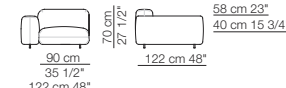

Elementi senza braccioli P.138
Units without armrests D.138

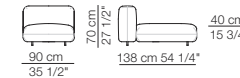

Pouf

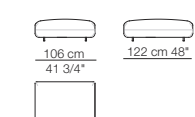
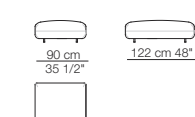
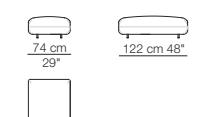
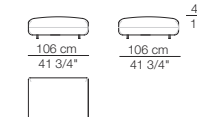
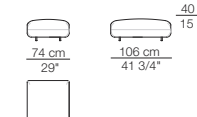
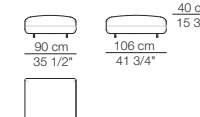
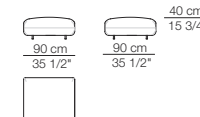
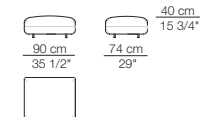

Composizioni
Compositions

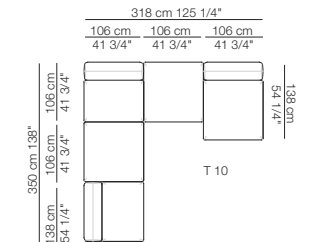
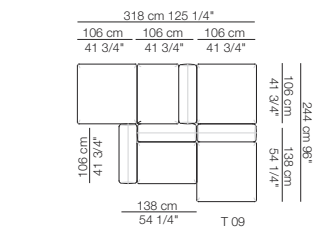
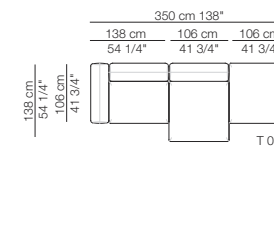
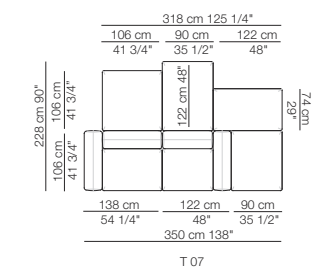
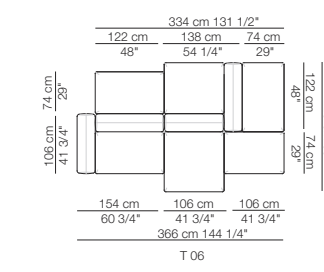
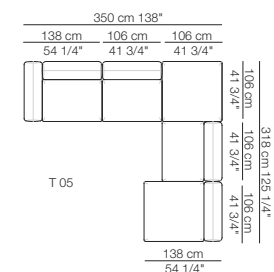
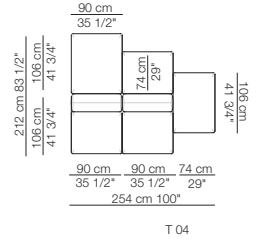
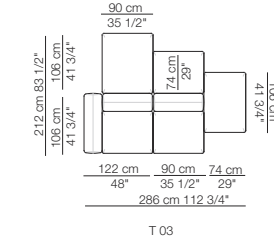
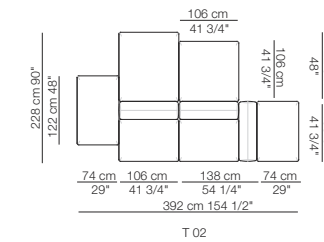
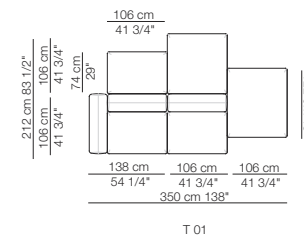



9000
Poltrona
Armchair

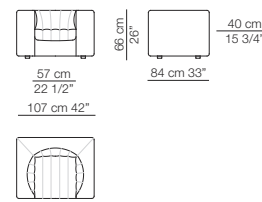

57 cm
22 1/2"
107 cm 42"
66 cm
26"
84 cm 33"
40 cm
15 3/4"



Algon
Poltrona con schienale basso
Armchair with low backrest



70 cm
27 1/2"
81 cm 32"
75 cm
29 1/2"
71 cm 28"
43 cm
17"



Algon
Poltrona con schienale alto
Armchair with high backrest

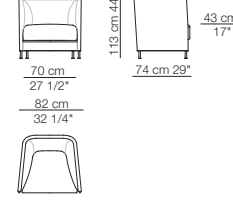

70 cm
27 1/2"
82 cm
32 1/4"
113 cm 44 1/2"
74 cm 29"
43 cm
17"



Butterfly
Poltrona
Armchair



80 cm
31 1/2"
80 cm
31 1/2"
38 cm
15"
75 cm
29 1/2"



Elettra
Poltrona
Armchair



62 cm
24 1/2"
71 cm 28"
72 cm 28 1/4"
46 cm
18"



Gloria
Poltrona con schienale basso
Armchair with low backrest



54 cm
21 1/4"
86 cm 34"
75 cm
29 1/2"
73 cm
28 3/4"
59 cm 23 1/4"
42 cm 16 1/2"



Gloria
Poltrona con schienale alto
Armchair with high backrest



54 cm
21 1/4"
86 cm 34"
93 cm 36 3/4"
82 cm
32 1/4"
59 cm 23 1/4"
42 cm 16 1/2"



Botolo
Poltrona versione bassa
Armchair low version



53 cm 21"
53 cm 21"
50 cm
19 3/4"
25 cm
10"



Botolo
Poltrona versione alta
Armchair high version



53 cm 21"
53 cm 21"
50 cm
19 3/4"
75 cm
29 1/2"



Cradle
Poltrona
Armchair



90 cm 35 1/2"
100 cm 39 1/2"
82 cm
32 1/4"
76 cm
30"



Service



64 cm
25 1/4"
82 cm
32 1/4"
Ø 24 cm 9 1/2"



Fiorenza
Poltrona
Armchair



47 cm
18 1/2"
73 cm
28 3/4"
103 cm 40 1/2"
92 cm 36 1/4"
66 cm 26"
42 cm
16 1/2"



Giulietta
Poltrona
Armchair



53 cm 21"
90 cm 35 1/2"
100 cm 39 1/2"
90 cm 35 1/2"
63 cm 21"
43 cm 17"



Hall
Poltrona
Armchair



58 cm 23"
99 cm 39"
82 cm 32 1/4"
86 cm 34"
50 cm 19 3/4"
41 cm 16"



Cross
Poltrona versione bassa
Armchair low version



66 cm 26"
87 cm 34 1/4"
69 cm 27"
41 cm
16"



Cross
Poltrona versione alta
Armchair high version



66 cm 26"
87 cm 34 1/4"
65 cm 33 1/2"
41 cm
16"



Delfino
Poltrona
Armchair



50 cm
19 3/4"
71 cm 28"
89 cm 35"
58 cm 23"
41 cm 16 1/4"
88 cm 35"



Pouf



55 cm
21 3/4"
64 cm
25 1/4"
44 cm
17 1/4"



Hug
Poltrona con schienale basso
Armchair with low backrest

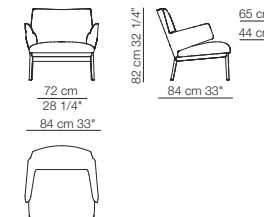

72 cm
28 1/4"
84 cm 33"
82 cm 32 1/4"
84 cm 33"
65 cm 25 3/4"
44 cm 17 1/4"



Hug
Poltrona con schienale alto
Armchair with high backrest

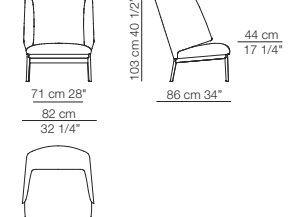

71 cm 28"
82 cm
32 1/4"
103 cm 40 1/2"
86 cm 34"
44 cm
17 1/4"



Katrin
Poltrona
Armchair

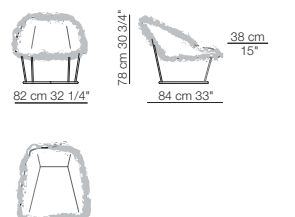

82 cm 32 1/4"
84 cm 33"
78 cm 30 3/4"
38 cm
15"

Poltrone / Armchairs



Ladle

Poltrona con schienale basso /
Basamento girevole a razze
Armchair with low backrest /
Swivel spoke base

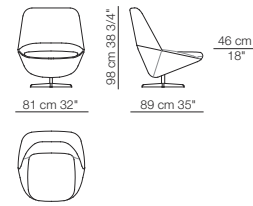

Ladle

Poltrona con schienale medio /
Basamento girevole a razze
Armchair with medium backrest /
Swivel spoke base

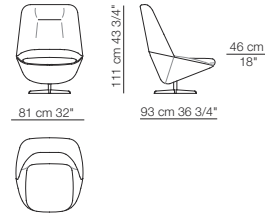

Ladle

Poltrona con schienale alto /
Basamento girevole a razze
Armchair with high backrest /
Swivel spoke base

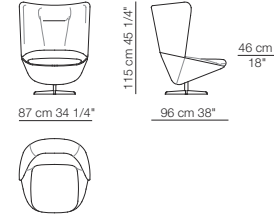

Pouf con basamento a razze (non girevole)
Pouf with spoke base (not swivel)

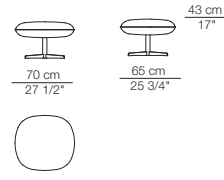

Poltrona con schienale basso /
Basamento in metallo
Armchair with low backrest /
Metal base

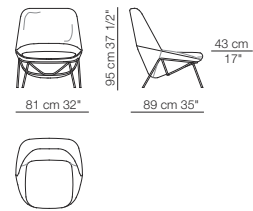

Poltrona con schienale medio /
Basamento in metallo
Armchair with medium backrest /
Metal base

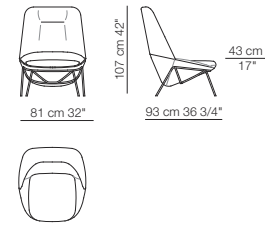

Poltrona con schienale alto /
Basamento in metallo
Armchair with high backrest /
Metal base

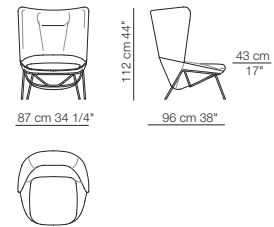

Leafo

Poltrona senza braccioli
Armchair without armrests

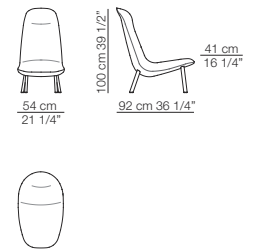

Leafo

Poltrona con 1 bracciolo (destra o sinistra)
Armchair with 1 armrest (right or left)

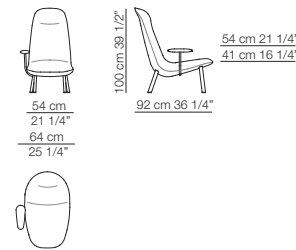

Leafo

Poltrona con 2 braccioli
Armchair with 2 armrests

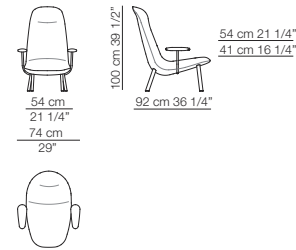

Pecorelle

Poltrona
Armchair

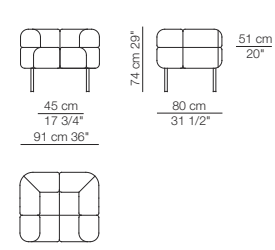

Poltrone / Armchairs



Jules

Poltrona
Armchair

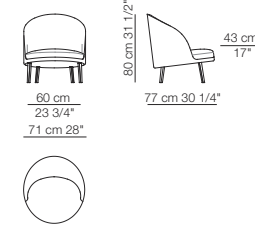

Jim

Poltrona
Armchair

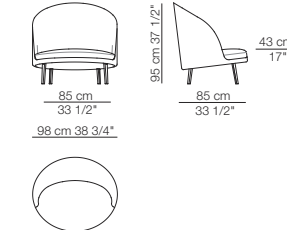

Serena & Doge

Poltrona Serena
Serena armchair

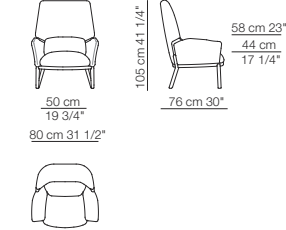

Pouf Doge

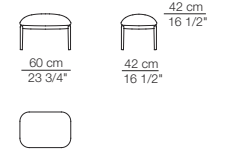

Suppli

Poltrona
Armchair

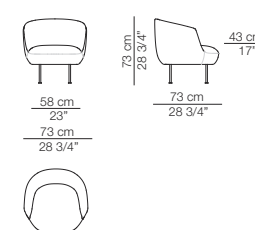

Tellin

Poltrona
Armchair

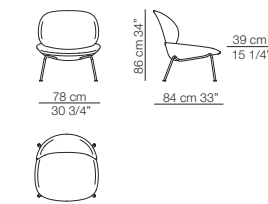

Virgola

Poltrona
Armchair

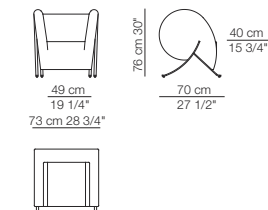



Botolo
Poltrona versione bassa
Armchair low version

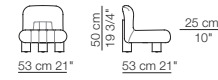

Botolo
Poltrona versione alta
Armchair high version

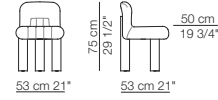

Brianza
Sedia senza braccioli
Chair without armrests

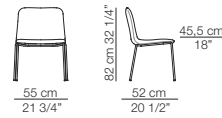

Brianza
Sedia con braccioli
Chair with armrests

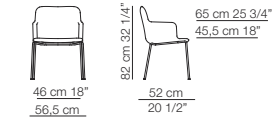

Banah
Dormeuse

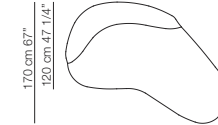
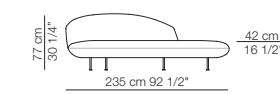

Bonsai
Divano con base in metallo
Sofa with metal base

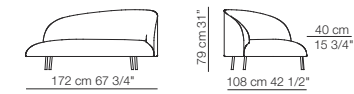

Divano con base in metallo e gonnella
Sofa with metal base and skirt

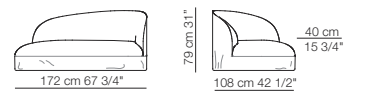

Elettra
Sedia
Chair

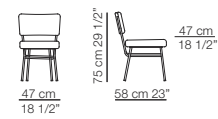

Hug
Sedia
Chair

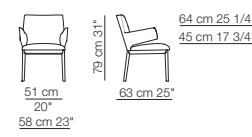

Neptunia
Sedia
Chair

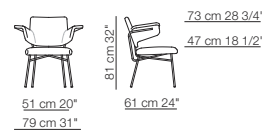

Orfeo
Sgabello H.102 cm
Stool H. 102 cm

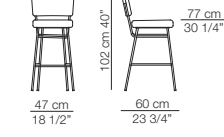

Sgabello H.92 cm
Stool H. 92 cm

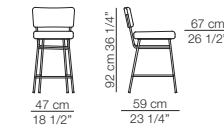

Cousy
Chaise longue con 2 braccioli
Chaise longue with 2 armrests

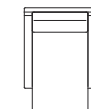
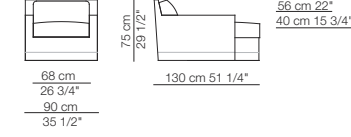

Sigmund
Panca
Bench

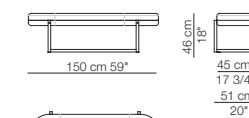

Hollywood
Chaise longue con 1 bracciolo
Chaise longue with 1 armrest

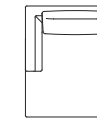
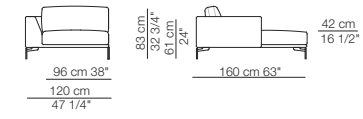

Sigmund
Daybed

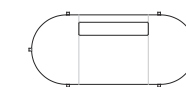
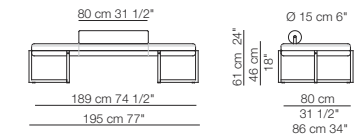

Tavoli / Tables



Goya lounge

Tavolo ø 90
Table ø 90

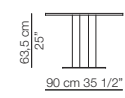

Tavolo 92 x 92
Table 92 x 92

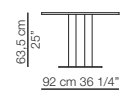

Tavolo ø 120
Table ø 120

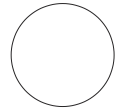
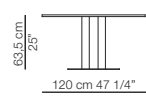

Tavolo 120 x 120
Table 120 x 120

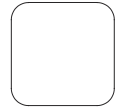
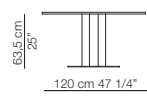

Goya lounge dining

Tavolo ø 90
Table ø 90

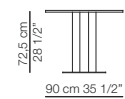

Tavolo 92 x 92
Table 92 x 92

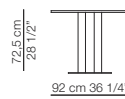

Tavolo ø 120
Table ø 120

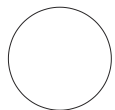
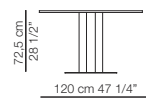

Tavolo 120 x 120
Table 120 x 120

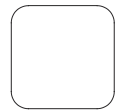
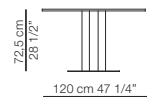

Tavolo ø 160
Table ø 160

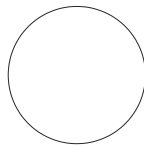
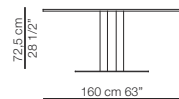

Match

Tavolo
Table

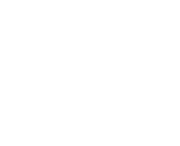
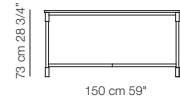
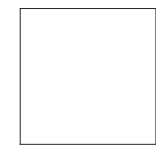
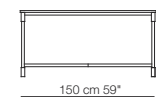

Hug

Tavolo
Table

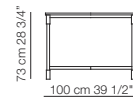
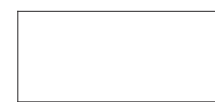
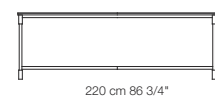
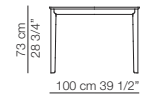

Tavolini / Small tables



Arcolor

Tavolino ø 30
Small table ø 30

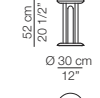

Arcolor

Tavolino ø 50
Small table ø 50

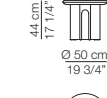

Arcolor

Tavolino ø 100
Small table ø 100

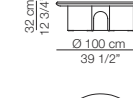

Bonsai

Tavolino
Small table

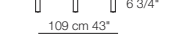
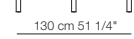

Capilano

Tavolino 55 x 55
Small table 55 x 55

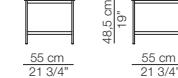

Capilano

Tavolino 96 x 30
Small table 96 x 30



Capilano

Tavolino 187,5 x 30
Small table 187,5 x 30

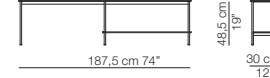

Cradle

Tavolino
Small table

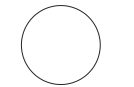
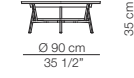

Goya

Tavolino ø 50
Small table ø 50

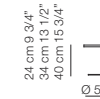

Tavolino 50 x 50
Small table 50 x 50

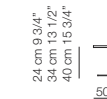

Service ø 50



Service 50 x 50

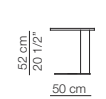

Tavolino 70 x 120
Small table 70 x 120

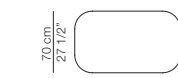
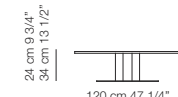

Tavolino ø 90
Small table ø 90

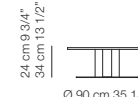

Tavolino 92 x 92
Small table 92 x 92

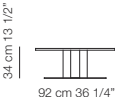

Tavolino ø 120
Small table ø 120

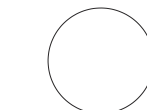
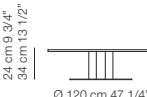

Tavolino 120 x 120
Small table 120 x 120

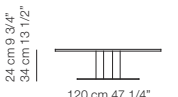

Tavolini / Small tables



Infinity
Tavolino 105 x 105
Small table 105 x 105

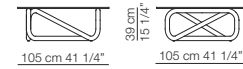

Infinity
Tavolino ø 130
Small table ø 130

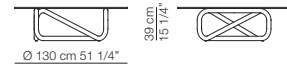

Match
Tavolino H.34 cm
Small table H.34 cm

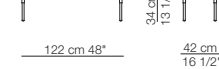

Match
Tavolino H.42 cm
Small table H.42 cm

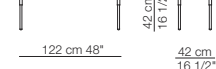

Island
Tavolino 56 x 56
Small table 56 x 56

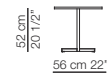

Island
Tavolino 98 x 98
Small table 98 x 98

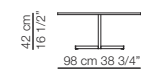

Island
Tavolino 120 x 60
Small table 98 x 98

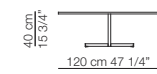

Island
Tavolino 140 x 50
Small table 140 x 50

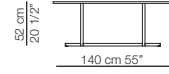

Sigmund
Tavolino 47 x 36
Small table 47 x 36

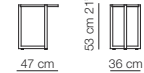

Sigmund
Tavolino 120 x 49
Small table 120 x 49

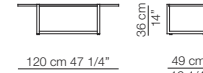

Tablet
Tavolino ø 50 H.31 cm
Small table ø 50 H.31 cm



Tablet
Tavolino ø 50 H.43 cm
Small table ø 50 H.43 cm



Tablet
Tavolino ø 80 H.31 cm
Small table ø 80 H.31 cm

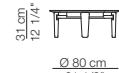

Tablet
Tavolino ø 80 H.43 cm
Small table ø 80 H.43 cm

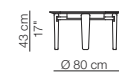

Tablet
Tavolino 109 x 109 H.31 cm
Small table 109 x 109 H.31 cm

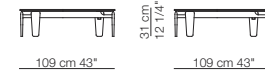

Librerie - Contenitori / Bookcases - Sideboards



Alba
Composizione libreria con 2 moduli
Bookcase composition with 2 units

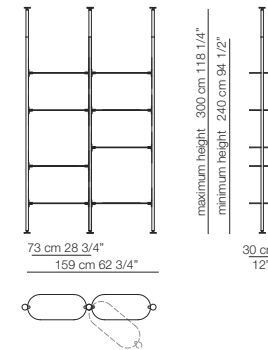

Composizione libreria con 3 moduli
Bookcase composition with 3 units

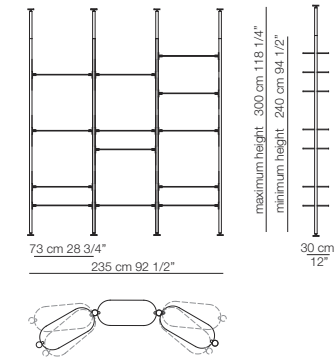

Composizione libreria con 4 moduli
Bookcase composition with 4 units

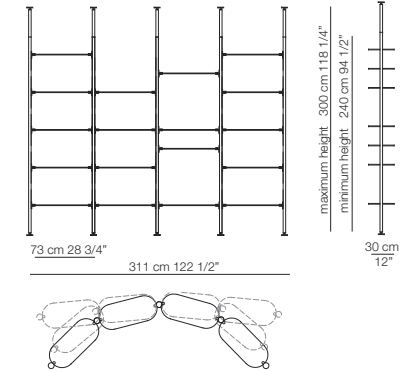



Match
Composizione libreria
Bookcase composition

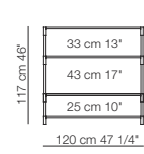

Composizione libreria
Bookcase composition

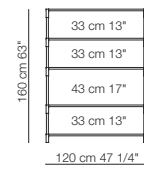

Composizione libreria
Bookcase composition

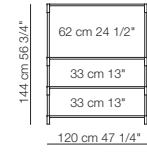

Composizione libreria
Bookcase composition

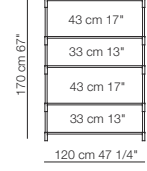

Composizione libreria
Bookcase composition

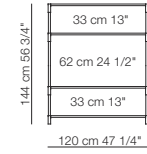

Composizione libreria
Bookcase composition

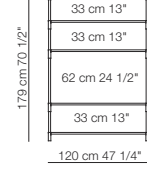

Composizione libreria
Bookcase composition

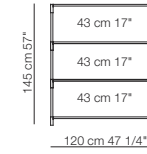

Composizione libreria
Bookcase composition

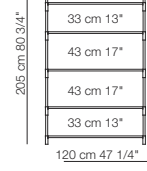

Rubycon
Contenitore 2 moduli
Sideboard 2 cubes

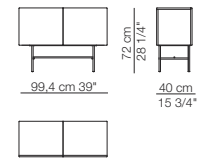

Contenitore 3 moduli
Sideboard 3 cubes

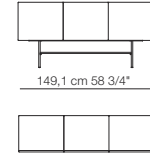

Contenitore 4 moduli
Sideboard 4 cubes

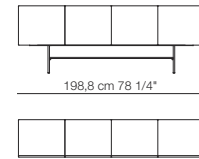

Contenitore 5 moduli
Sideboard 5 cubes

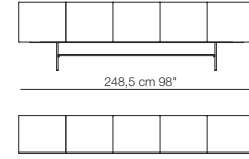

Diva

Accessorio
Accessory

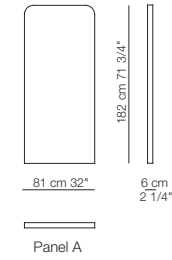

Accessorio
Accessory

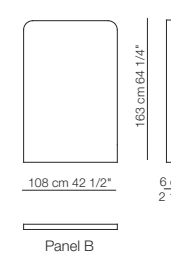

Accessorio
Accessory

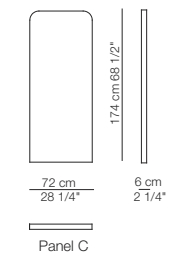

Accessorio
Accessory

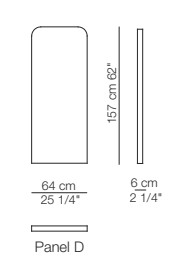

Accessorio
Accessory

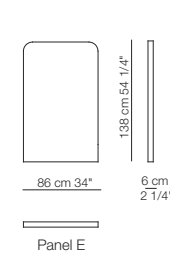

Accessorio
Accessory

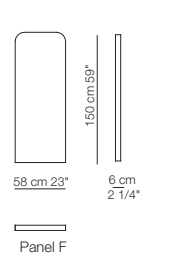

Ciclope

Specchio
Mirror

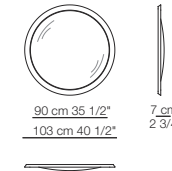

Delfino

Pouf

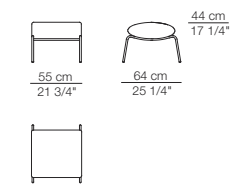

Doge

Pouf

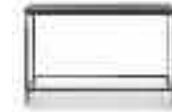
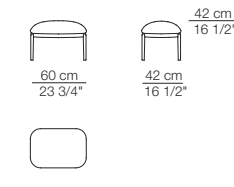

Match

Console

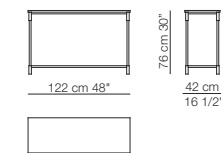



Penta
Pouf

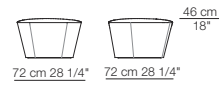

Penta
Pouf

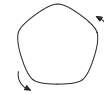
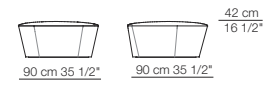

Penta
Pouf

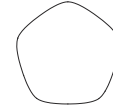
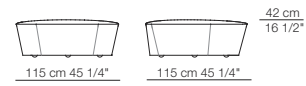

Pouf
Pouf

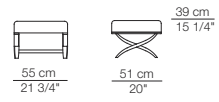

Papillon
Lampada da parete
Wall lamp

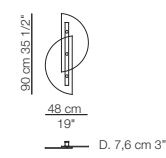

Ponti
Scrivitoio
Writing desk

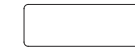
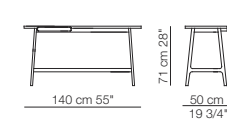

Sigmund
Scrivitoio
Writing desk

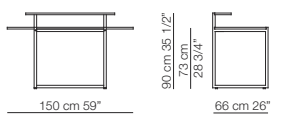

Vela
Accessorio
Accessory

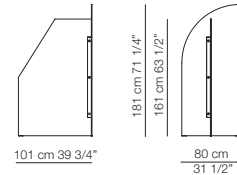

Code **A**
Colori : rosa e azzurro
Colours : pink and light blue



Vela
Accessorio
Accessory

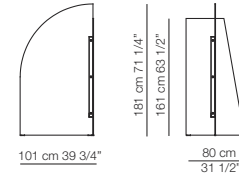

Code **C**
Colori : verde e azzurro
Colours : green and light blue



Vela
Accessorio
Accessory

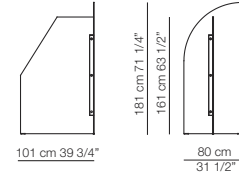

Code **D**
Colori : rosa e bronzo
Colours : pink and bronze



Threshold
Mobile specchiera basso
Low mirror cabinet

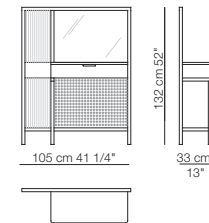

Mobile specchiera alto
High mirror cabinet

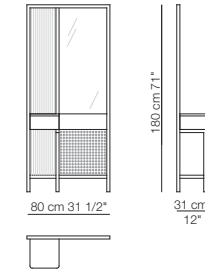

Contacts

arflex

via Pizzo Scalino 1
20833 Giussano (MB)
Italy
Tel +39 0362 853043
Fax +39 0362 354010
Skype : arflexdesign
www.arflex.com
info@arflex.it

Credits

Photography

Gumiero Walter
KB
Lovatti Davide
Pagani Thomas

AD

Bernhardt-Vella

Styling

Bernhardt-Vella

Printed

July 2021

Copyright

seven salotti spa
All rights reserved 2021

Thanks to

Atelier Areti
CCtapis
Michele Reginaldi
Rob Sherwood
Schiavo Zoppelli Gallery