



EXPERIENCE QUALITY DESIGN

  
**RAMBERTI**  
group

MADE IN ITALY 

# RAMBERTI GROUP

it /

La produzione degli articoli avviene totalmente negli stabilimenti produttivi del gruppo.

Le diverse realtà industriali, **direttamente controllate e facenti capo al Gruppo Ramberti**, consentono una **attenta verifica delle materie prime impiegate** e della **qualità** dei prodotti:

- dal filato al tessuto;
- dalle strutture in alluminio alle stecche degli ombrelloni;
- dagli articoli in legno ai complementi d'arredo.

Ogni azienda è specializzata nella produzione specificata al fine di valorizzare l'esperienza artigianale della manodopera, permettendo una attenzione sartoriale ai dettagli.

en /

The production of the items takes place entirely in the production plants of the group.

The various industrial realities, **directly controlled and headed by the Ramberti Group**, allow a **careful verification of the raw materials used**, and the **quality** of the products:

- from yarn to fabric;
- from the aluminum structures to the ribs of parasols;
- from wooden items to furnishing accessories.

Each company specializes in the specified production in order to enhance the craftsmanship experience of the workforce, allowing a tailored attention to detail.



## RAMBERTI

it / Azienda di produzione.

Montaggio e confezionamento dei semilavorati provenienti dalle altre aziende del gruppo.

en / Production Company, for the assembly and the packaging of semi-finished products from other companies in the Group.

## Migani

it / Azienda di produzione per la lavorazione del legno e dell'alluminio.

en / Production Company for the processing of wood and aluminum.

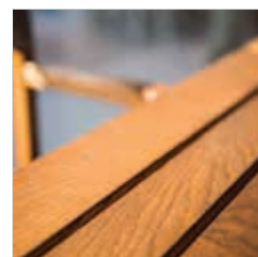

## ALL SUN

it / Azienda di produzione per la lavorazione dell'alluminio, con speciali macchine dedicate piegatubi e centri di lavoro.

en / Production Company, for the processing of aluminum, with special dedicated tube bending machines and work centers.

## RAMFIL

it / Azienda di produzione del filato e tessitura.

en / Production Company for yarn and weaving.

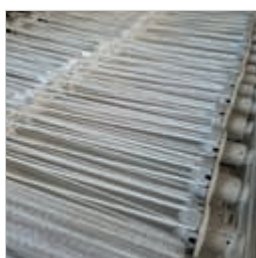

## 12thLIVING

it / Azienda di produzione per le strutture degli ombrelloni.

en / Production Company for parasol structures.

# RAMBERTI GROUP

fr /

La fabrication des articles a lieu entièrement dans les usines de production du groupe.

Les différentes réalités industrielles, **contrôlées directement et appartenant au Groupe Ramberti**, permettent une **vérification minutieuse des matières premières utilisées** et de la **qualité** des produits :

- du fil au tissu;
- des structures en aluminium aux baleines des parasols ;
- des articles en bois aux accessoires d'ameublement.

Chaque entreprise se spécialise dans une production spécifique afin d'améliorer l'expérience artisanale de la main-d'œuvre, ce qui permet une attention personnalisée aux détails.

es /

La producción de los artículos se realiza íntegramente en las instalaciones de producción del grupo.

Las distintas empresas industriales, **controladas directamente por el Grupo Ramberti y pertenecientes al mismo**, permiten **verificar cuidadosamente las materias primas utilizadas** y la **calidad** de los productos:

- del hilo a la tela;
- desde estructuras de aluminio hasta varillas para sombrillas;
- desde artículos de madera hasta accesorios de decoración.

Cada empresa se especializa en la producción especificada para potenciar el trabajo artesanal de la mano de obra, lo que permite prestar atención a los detalles a medida.

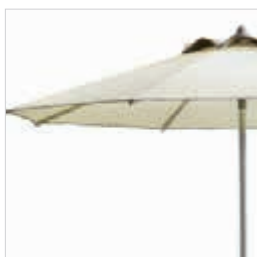

## RAMBERTI

fr / Entreprise de production, assemblage et conditionnement, de produits semi-finis provenant d'autres sociétés du Groupe.

es / Empresa de producción. Montaje y envasado de productos semiacabados de otras empresas del grupo.

## Migani

fr / Entreprise de production pour la transformation du bois et de l'aluminium.

es / Empresa de producción para la elaboración de madera y aluminio.

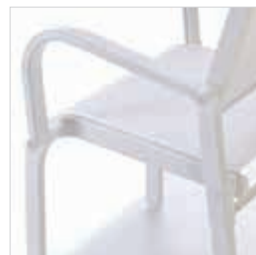

## ALL SUN

fr / Entreprise de production pour le traitement de l'aluminium, avec des cintruses de tubes et des centres d'usinage spéciaux dédiés.

es / Empresa de producción para la transformación del aluminio, con máquinas curvadoras y centros de mecanizado especiales.

## RAMFIL

fr / Entreprise de production et de tissage de fil et de tissu.

es / Empresa de producción del tejido de hilos.

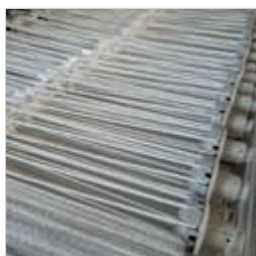
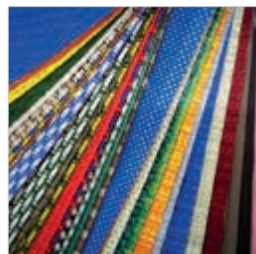

## 12thLIVING

fr / Société de production de structures des parasols.

es / Empresa de producción de estructuras de parasolas.

# Una storia di famiglia A family history

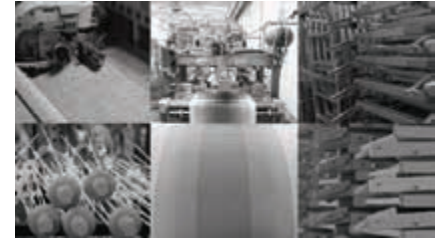

1918

it / **Francesco Ramberti** inaugura l'attività imprenditoriale della famiglia come artigiano di selle per cavalli, comprando la prima macchina per cucire.

en / **Francesco Ramberti** inaugurates the business activity of the family as a craftsman of horse saddles, buying the first sewing machine.

1945...

it / Con lo sviluppo delle automobili, l'azienda inizia la produzione di teloni per camion.

en / With the development of automobiles, the company began the production of tarpaulins for trucks.

1957...

it / Con l'esplosione del turismo sulla riviera romagnola, inizia la produzione di lettini e ombrelloni.

**Antonio e Roberto**, figli di Francesco, fanno il loro ingresso in azienda.

en / With the explosion of tourism on the Romagna riviera, the production of sunbeds and parasols begins. **Antonio and Roberto**, Francesco's son, join the company.

1980...

it / **Riccardo**, figlio di Antonio, fa il suo ingresso in azienda. Entrambi sono ancora la timone del gruppo.

en / **Riccardo**, Antonio's son, joins the company. Both are still at the helm of the Group.

1992...

it / Apre il primo **Ramberti Point ad Albenga** in Liguria.

en / The first **Ramberti Point** opens in **Albenga**, Liguria.

1995...

it / **Antonio e Riccardo** liquidano la quota di Roberto.

en / **Antonio and Riccardo** liquidate Roberto's share.

2001...

it / Viene inaugurata **All Sun Srl** per la lavorazione dell'alluminio.

en / **All Sun Srl** is inaugurated for the processing of aluminium.

2012...

it / **Migani Industrie Srl** viene acquisita per la lavorazione del legno e dell'alluminio.

en / **Migani Industrie Srl** is acquired for the processing of wood and aluminium.

2014...

it / Viene inaugurata **Ramfil Srl** per la produzione del filo e del tessuto.

en / **Ramfil Srl** is inaugurated for the production of yarn and fabric.

2017...

it / Entra in azienda il primo figlio di Riccardo: **Luca**. Viene inaugurata **12 Living Srl** per la produzione dei componenti per gli ombrelloni.

en / Riccardo's first son joins the company: **Luca**. **12th Living Srl** is inaugurated for the production of parasol structures.

2019...

it / Apre il secondo **Ramberti Point a Barletta** in Puglia. Inaugura il **Ramberti beach 182** in Brasile.

en / The second **Ramberti Point** opens in **Barletta**, Puglia. **Ramberti beach 182** is inaugurated in Brazil.

2020...

it / Apre il terzo **Ramberti Point a Cisterna di Latina** nel Lazio.

en / The third **Ramberti Point** opens in **Cisterna di Latina**, Lazio.

2021...

it / Viene inaugurato **Ramberti Cuba**.

en / **Ramberti Cuba** is inaugurated.

2022...

it / Entra in azienda la seconda figlia di Riccardo: **Elisa**.

en / Riccardo's daughter joins the company: **Elisa**.

oggi

*105 anni di storia e 3 generazioni in azienda*  
*14.000 m<sup>2</sup> di stabilimenti*  
*50.000 articoli prodotti ogni anno*  
*200 km tessuti confezionati ogni anno*

today

*105 years of history and 3 generations in the company*  
*14,000 m<sup>2</sup> of production plants*  
*50,000 items produced every year*  
*200 km of fabrics manufactured every year*

# Une histoire de famille Una historia familiar



fr / **Francesco Ramberti** inaugure l'entreprise familiale en tant qu'artisan de selles de chevaux, en achetant la première machine à coudre.

1918

es / **Francesco Ramberti** inicia el negocio familiar como fabricante de es / sillas de montar, comprando la primera máquina de coser.

1945...

fr / Avec le développement des voitures, l'entreprise commence la production de bâches pour camions.

es / Con el desarrollo de los automóviles, la empresa inició la producción de lonas para camiones.

1957...

fr / Avec l'explosion du tourisme sur la Riviera Romagnola, la production de transats et de parasols commence. **Antonio et Roberto**, fils de Francesco, rejoint l'entreprise.

es / Con la explosión del turismo en la costa romañola, comenzó la producción de tumbonas y sombrillas. El hijo de Francesco, **Antonio y Roberto**, se incorporan a la empresa.

1980...

fr / **Riccardo**, le fils d'Antonio, entre dans l'entreprise. Tous deux sont toujours aux commandes du groupe.

es / **Riccardo**, el hijo de Antonio, se incorpora a la empresa. Ambos siguen al frente del grupo.

1992...

fr / Le premier **Ramberti Point** ouvre à **Albenga** en Ligurie.

es / Se abre el primer **Punto Ramberti** en **Albenga**, Liguria.

1995...

fr / **Antonio et Riccardo** liquident la part de Roberto.

es / **Antonio y Riccardo** liquidan la parte de Roberto.

2001...

fr / **All Sun Srl** a été inaugurée pour le traitement de l'aluminium.

es / Se inaugura **All Sun Srl** para la elaboración del aluminio.

2012...

fr / **Migani Industrie Srl** a été acquise pour le traitement du bois et de l'aluminium.

es / Se adquiere **Migani Industrie Srl** para la elaboración de la madera y el aluminio.

2014...

fr / **Ramfil Srl** a été inaugurée pour la production et de tissage de fil et de tissu.

es / Se inaugura **Ramfil Srl** para la producción de hilos y tejidos.

2017...

fr / Le premier fils de Riccardo entre dans l'entreprise : **Luca**. **12 Living Srl** a été inaugurée pour la production de structures des parasols.

es / El primer hijo de Riccardo se incorpora a la empresa: **Luca**. Se inaugura **12 Living Srl** para la producción de componentes de sombrillas.

2019...

fr / Le deuxième **Ramberti Point** ouvre à **Barletta** dans les Pouilles. **Ramberti beach 182** a été inaugurée au Brésil.

es / Se abre el segundo **Ramberti Point** en **Barletta**, Apulia. Se inaugura **Ramberti beach 182** en Brasil.

2020...

fr / Le troisième **Ramberti Point** ouvre à **Cisterna di Latina** dans le Latium.

es / El tercer **Punto Ramberti** se abre en **Cisterna di Latina**, en el Lacio.

2021...

fr / **Ramberti Cuba** a été inauguré.

es / Se inaugura **Ramberti Cuba**.

2022...

fr / La fille de Riccardo, **Elisa** entre dans l'entreprise.

es / La segunda hija de Riccardo, **Elisa**, se incorpora a la empresa.

aujourd'hui

105 ans d'histoire et 3 générations l'entreprise

14 000 m<sup>2</sup> de stabilité

50 000 articles produits chaque année

200 km tissus fabriqués chaque année

hoy

105 años de historia y 3 generaciones en la empresa

14 000 m<sup>2</sup> de fábricas

50 000 artículos producidos cada año

200 km de tejidos confeccionados cada año





it / I SEGRETI DEL NOSTRO SUCCESSO SONO PERSEVERANZA E IMPEGNO, CONTINUITÀ NELLA TRADIZIONE, ESPERIENZA ARTIGIANALE E UN'ATTENZIONE SARTORIALE AI DETTAGLI, ALLA QUALITÀ E AL DESIGN.

en / THE SECRETS OF OUR SUCCESS ARE PERSEVERANCE AND COMMITMENT, CONTINUITY IN TRADITION, CRAFTSMANSHIP EXPERIENCE, AND A TAILOR'D ATTENTION TO DETAILS, QUALITY, AND DESIGN.

fr / LES SECRETS DE NOTRE SUCCÈS SONT LA PERSÉVÉRANCE ET L'ENGAGEMENT, LA CONTINUITÉ DANS LA TRADITION, L'EXPÉRIENCE DE L'ARTISANAT ET UNE ATTENTION SARTORIELE AUX DÉTAILS, À LA QUALITÉ ET AU DESIGN.

es / LOS SECRETOS DE NUESTRO ÉXITO SON LA PERSEVERANCIA Y EL COMPROMISO, LA CONTINUIDAD DE LA TRADICIÓN, LA ARTESANÍA Y UNA ATENCIÓN SARTORIAL A LOS DETALLES, LA CALIDAD Y EL DISEÑO.

# INDICE

## INDEX

### LETTINI E SDRAIO / SUNBEDS AND DECKCHAIRS TRANSATS ET CHILIENNES / TUMBONAS Y SILLAS

Portofino	9	Base 3P	22
Santorini	10	T3	23
Big	11	T4	24
Luxury	13	T3 new	25
Relax	15	Kommodo	26
Letto legno	16	Riccione	27
Wooden sunbed		Rio	28
Transat en bois		Lettoni per disabili	30
Tumbona de madera		Sunbeds for disabled people	
Sdraio legno	17	Transats pour personnes à mobilité réduite	
Wooden Deckchair		Tumbonas para personas con discapacidades	
Chilienne en bois		Sedia a rotelle per disabili	30
Tumbona de madera		Beach Wheelchair	
Marinella legno	18	Fauteuil roulant pour personnes à mobilité réduite	
		Silla de ruedas para personas con discapacidades	

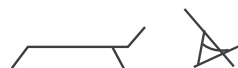

8

Accessori	31-32
Accessories	
Accessoires	
Accesorios	
Letto cani	33
Dog sunbed	
Transat pour chien	
Cama para perros	
Marinella	34
Sdraio in alluminio	35
Aluminium deckchair	
Chilienne en aluminium	
Tumbona de aluminio	

### OMBRELLONI / PARASOLS / PARASOLS / SOMBRILLAS

Tradizionale	42	Baltico	45
Pagodina	43	Majestic	46
Pagoda	44	Majestic 2	47
Tukul	45	Big Majestic	48

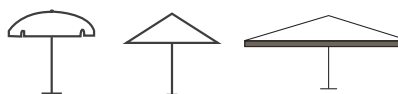

36

Piazza (telescopico)	53
Accessori	52-55-56
Accessories	
Accessoires	
Accesorios	

### Daybed



57

### Tendombra



59

### Gazebo / Gazebos / Gazebos / Gazebo



60

### Pedane / Platforms / Plateformes / Plataformas



62

### Cabine / Beach Cabins / Cabines / Cabinas



64

### SEDUTE E TAVOLI / SEATS AND TABLES SIÈGES ET TABLES / ASIENTOS Y MESAS

Samantha	66	Taverna	73
Regista	67-70	Elegant	74
Director's chair		Elegant H	76
Metteur en Scène		Piani tavolo/Table tops/Plateaux de table/Tableros de mesa	77
Regista		Tavoli pieghevoli/Folding Tables/ Tables pliantes/Mesas plegables	79
Aurora	70	Tavoli bassi/Low tables/Table basses/Mesas bajas	79
Sgabello Regista	69-72		
Director's stool			
Fauteuil de Metteur en Scène			
Taburete de director			



65

### COLLEZIONI / COLLECTIONS / COLLECTIONS / COLECCIONES

Happy	81
Libeccio	82
Maestrone	82
Sorrento	83
Esaedro	84
Scrigno	86
Panca Wellness/Wellness bench/Banc Wellness/Banco Wellness	89

81

### TOVAGLIETTE / PLACEMATES / NAPPERONS/MANTELES INDIVIDUALES

### TESSUTI / FABRICS / TISSUS / TEJIDOS



88

92





Lettini e Sdraio  
Sunbeds and Deckchairs  
Transats et Chiliennes  
Tumbonas y Silla de playa





# PORTOFINO

 misure / sizes

 L 200 cm  
P 79 cm  
H 40 cm

 impilabile  
stackable  
empilable  
apilable

 L 200 cm  
P 100 cm  
H 50 cm  
Kg 35

 L 200 cm  
P 100 cm  
H 170 cm  
Kg 180



CON RUOTE / WITH WHEELS  
AVEC ROULETTES / CON RUEDAS



CUSCINO / CUSHION  
COUSSIN / COJÍN

it / Lettino adatto per piscine e aree relax. 5 diverse posizioni dello schienale con meccanismo a cremagliera, per un maggiore comfort. Partendo dalla posizione stesa è possibile scegliere le altre quattro alzando semplicemente lo schienale.

Tessuto COR o RAM. Telaio in alluminio disponibile nei colori bianco, talpa, antracite. Dotato di un comodo portatelo nella parte sottospalliera. Regolazione dello schienale senza cordella. Le ruote, inserite nel telaio, consentono la movimentazione del lettino. Impilabile. Ferramenta inox AISI 316.

en / Sunbed suitable for swimming pools and relaxation areas. The ropeless rack mechanism allows to adjust 5 different backrest positions for maximum comfort. Starting from the horizontal position, it is possible to choose the other four by simply raising the backrest. COR or RAM fabrics. Aluminum frame available in white, taupe, anthracite colors. Equipped with a comfortable towel holder. The wheels inserted into the frame allow for easy movement of the bed. Stackable. Hardware Inox AISI 316.

fr / Transat idéal pour les piscines et les espaces de détente. 5 positions différentes du dossier avec mécanisme à crémaillère pour un maximum de confort. A partir de la position allongée, il est possible de choisir les quatre autres en relevant simplement le dossier. Tissus COR ou RAM. Structure en aluminium disponible dans les couleurs blanc, taupe, anthracite. Équipé d'un porte-serviette confortable sur le dessus. Réglage du dossier sans cordon.

es / Tumbona adecuada para piscinas y zonas de relax. 5 posiciones diferentes de respaldo con un mecanismo de cremallera para mayor comodidad. Partiendo de la posición tumbada, es posible elegir las otras cuatro simplemente levantando el respaldo. Tejido COR o RAM. Estructura de aluminio disponible en blanco, gris taupé y antracita. Equipada con un cómodo soporte en la parte inferior. Ajuste del respaldo sin cuerda. Las ruedas integradas en la estructura permiten desplazar la tumbona. Apilable. Herrajes de acero inoxidable AISI 316.



TELAIO:  
FRAME:  
STRUCTURE:  
ESTRUCTURA:

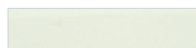

BIANCO  
WHITE  
BLANC  
BLANCO



ANTRACITE  
ANTHRACITE  
ANTRACITA



TALPA  
TAUPE  
TAUPE  
TOPO

CARTER SALVADITA  
MECCANISMO  
A CREMAGLIERA  
  
CARTER SAVE FINGERS  
ROPELESS RACK  
MECHANISM

CARTER DE SÉCURITÉ  
MÉCANISME À CRÉ-  
MAILLÈRE  
  
PROTECCIÓN DE DEDOS  
MECANISMO  
DE CREMALLERA



5 POSIZIONI  
5 POSITIONS  
**5**



# SANTORINI

 misure/ sizes



L 206 cm  
P 64 cm  
H 40 cm



impilabile  
stackable  
empilable  
apilable



1 pz

L 190 cm  
P 65 cm  
H 50 cm  
Kg 9,5



10 pz

L 200 cm  
P 80 cm  
H 180 cm  
Kg 110

it / Lettino adatto per piscine e aree relax. Dotato di 4 inclinazioni dello schienale con scaletta. Tessuto COR o RAM.  
Telaio in alluminio disponibile nei colori bianco e antracite.  
Impilabile. Ferramenta inox AISI 316.

en / Sunbed suitable for swimming pools and relaxation areas. Equipped with 4 ropeless backrest inclinations by ladder. COR or RAM fabrics.  
Aluminum frame available in white and anthracite colors  
Stackable. Hardware Inox AISI 316.

fr / Transat idéal pour les piscines et les espaces de détente. Équipé de 4 inclinaisons de dossier avec échelle. Tissus COR ou RAM.  
Structure en aluminium disponible dans les couleurs blanc et anthracite.  
Empilable. Quincaillerie en acier inoxydable AISI 316.

es / Tumbona adecuada para piscinas y zonas de relax. Equipada con 4 inclinaciones de respaldo con niveles. Tejido COR o RAM.  
Estructura de aluminio disponible en blanco y antracita.  
Apilable. Herrajes de acero inoxidable AISI 316.



**OPZIONI / OPTIONS /  
OPTIONNEL / Opciones P.31:**

Parasole/Sunshield/Pare-soleil/Parasol

Ruote/Wheels/Roulettes/Ruedas



**TELAIO:  
FRAME:  
STRUCTURE:  
ESTRUCTURA:**

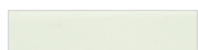

BIANCO  
WHITE  
BLANC  
BLANCO



ANTRACITE  
ANTHRACITE  
ANTRACITE  
ANTRACITA



4 POSIZIONI  
4 POSITIONS





# BIG

 misure/ sizes



L 200 cm  
P 100 cm  
Hs 22-47 cm



1 pz

L 200 cm  
P 100 cm  
H 8 cm  
Kg 36,3



15 pz

L 200 cm  
P 100 cm  
H 140 cm  
Kg 230

+



60 pz

L 120 cm  
P 80 cm  
H 90 cm  
Kg 160

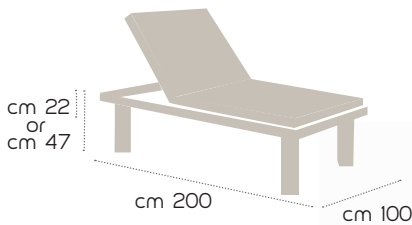

Disponibile con altezza 22 cm.  
Available with height 22 cm.  
Disponibile avec hauteur 22 cm.  
Disponibile con altura 22 cm.

it / Lettino con telaio in alluminio verniciato. 4 diverse posizioni dello schienale con meccanismo a cremagliera. Partendo dalla posizione stesa è possibile scegliere le altre alzando semplicemente lo schienale. Con materassino filtrante h.10 cm. Disponibile con altezza seduta h. 22 cm o 47 cm. Tessuto RAM. Ferramenta inox AISI 316.

en / Sunbed with powder coated aluminum frame. The ropeless rack mechanism allows to adjust 4 different backrest positions. Starting from the horizontal position, it is possible to choose the other four by simply raising the backrest. Available with seat height h. 22 cm or 47 cm, and with filtering mattress h 10 cm. RAM fabric Hardware Inox AISI 316.

fr / Transat avec structure en aluminium peint avec des poudres époxy. 4 positions du dossier différentes avec mécanisme à crémaillère. A partir de la position allongée, il est possible de choisir les autres en relevant simplement le dossier. Option: matelas filtrant h.10 cm. Disponible avec une hauteur d'assise h. 22 cm ou 47 cm. Tissu RAM. Quincaillerie en acier inoxydable AISI 316.

es / Tumbona con estructura de aluminio pintado. 4 posiciones diferentes de respaldo con mecanismo de cremallera. Partiendo de la posición tumbada, se pueden elegir otras simplemente levantando el respaldo. Con colchoneta filtrante de 10 cm de altura. Disponible con altura de asiento de 22 cm o 47 cm. Tejido RAM. Herrajes de acero inoxidable AISI 316.



Materassino/Mattress/Matelas/Colchoneta  
h 10 cm

4 POSIZIONI  
4 POSITIONS





- ▶ 1 ACCOPPIAMENTO TESTA / TESTA  
HEAD / HEAD COUPLING  
COUPLAGE TÊTE / TÊTE  
ACLOPAMIENTO CABEZA / CABEZA
- ▶ 2 ACCOPPIAMENTO TESTA / PIEDI  
HEAD / FEET COUPLING  
COUPLAGE TÊTE / PIEDS  
ACLOPAMIENTO CABEZA / PIE

TESSUTO LETTINO:  
SUNBED FABRIC:  
TISSU DU TRANSAT:  
TEJIDO DE TUMBONA:



RAM 102



RAM 106

TESSUTO MATERASSO:  
MATTRESS FABRIC:  
TISSU DU MATELAS:  
TEJIDO DE LA COLCHONETA:



MILANO  
bianco



MILANO  
talpa

TELAIO:  
FRAME:  
STRUCTURE:  
ESTRUCTURA:

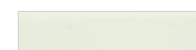

BIANCO  
WHITE  
BLANC  
BLANCO

Su richiesta può essere realizzato con altre finiture.  
On request it can be made in other finishes.  
Sur demande, il peut être réalisé avec d'autres finitions.  
Se puede fabricar con otros acabados a petición del cliente.

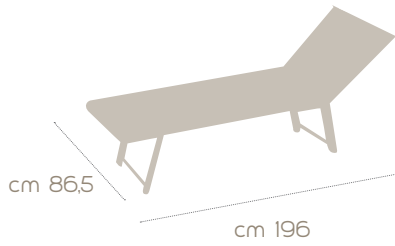

## LUXURY

it / Lettino con struttura in legno di frassino di prima qualità e struttura interna in alluminio verniciato. 6 inclinazioni dello schienale con scaletta. Tessuto COR o RAM. Adatto per l'esterno perchè trattato con impregnazione del legno a più mani con speciali vernici in vasche di colore e con incollaggio delle parti in legno tramite speciale colla marina. Ferramenta inox AISI 316. Essendo legno, si raccomanda una manutenzione con prodotti specifici per tale materiale.

en / Sunbed with structure in first quality ash wood, and with internal structure in powder coated aluminum, with 6 ropeless backrest inclinations by ladder. COR or RAM fabrics. Suitable for outdoors because treated with impregnation of the wood in several hands with special paints in color vats, and with gluing of the wooden parts using special marine glue, Hardware Inox AISI 316. Being wood, the maintenance with specific products for this material is recommended.



6 POSIZIONI  
6 POSITIONS

6





 misure/ sizes



L 196 cm  
P 86,5 cm  
H 33



1 pz

L 196 cm  
P 80 cm  
H 7 cm  
Kg 19,5



20 pz

L 200 cm  
P 80 cm  
H 160 cm  
Kg 400

fr / Transat avec structure en bois de frêne de haute qualité et structure interne en aluminium peint avec des poudres époxy. 6 inclinaisons de dossier avec échelle. Tissu COR ou RAM. Idéal pour l'extérieur car il est traité avec une imprégnation du bois en plusieurs couches avec des peintures spéciales dans des baignoires avec couleur. Le collage des parties en bois est réalisée à l'aide d'une colle marine spéciale. Quincaillerie en acier inoxydable AISI 316.

Cependant, étant du bois, un entretien avec des produits spécifiques pour ce matériau est recommandé

es / Tumbona con estructura de madera de fresno de alta calidad y estructura interior de aluminio pintado. 6 inclinaciones de respaldo con niveles. Tejido COR o RAM.

Adecuada para exteriores porque ha sido tratada impregnando la madera en varias capas con pinturas especiales en tanques de color y pegando las partes de madera con cola marina especial. Herrajes de acero inoxidable AISI 316.

Al ser de madera, se recomienda el mantenimiento con productos específicos para dicho material.

**TESSUTO LETTINO:**  
**SUNBED FABRIC:**  
**TISSU DU TRANSAT:**  
**TELA DE TUMBONA:**



RAM 102



RAM 106



COR jersey

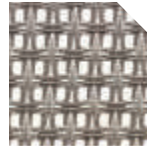

COR mosquito

**COLORI LEGNO:**  
**WOOD COLORS:**  
**COULEURS DE BOIS:**  
**COLORES DE MADERA:**

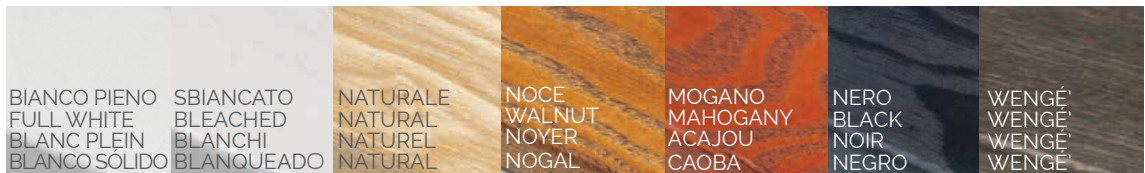



misure/ sizes



L 196,5 cm  
P 72/86,5 cm  
H 35,5



1 pz

L 166 cm  
P 65 cm  
H 9 cm  
Kg 25,5



15 pz

L 200 cm  
P 80 cm  
H 150 cm  
Kg 400

# RELAX

it / Lettino con struttura a doghe in legno di frassino di prima qualità. 6 inclinazioni dello schienale, con scaletta. Con materassino filtrante h.10 cm. Adatto per l'esterno perchè trattato con impregnazione del legno a più mani con speciali vernici in vasche di colore e con incollaggio delle parti in legno tramite speciale colla marina. Ferramenta inox AISI 316. Essendo legno, si raccomanda una manutenzione con prodotti specifici per tale materiale.

en / Sunbed with wooden slats, with structure in first quality ash wood, with 6 ropeless backrest inclinations by ladder, with filtering mattress h 10 cm. Suitable for outdoors because treated with impregnation of the wood in several hands with special paints color vats, and with gluing of the wooden parts using special marine glue. Hardware Inox AISI 316. Being wood, the maintenance with specific products for this material is recommended.

fr / Transat avec structure à lattes en bois de frêne de haute qualité. 6 inclinaisons de dossier avec échelle. Avec matelas filtrant h.10 cm. Idéal pour l'extérieur car il est traité avec une imprégnation du bois en plusieurs couches avec des peintures spéciales dans des baignoires avec couleur. Collage des parties en bois est réalisée à l'aide d'une colle marine spéciale. Quincaillerie en acier inoxydable AISI 316. Cependant, étant du bois, un entretien avec des produits spécifiques pour ce matériau est recommandé.

es / Tumbona con estructura listones de madera de fresno de alta calidad. Respaldo reclinable en 6 niveles diferentes. Con colchoneta filtrante de 10 cm de altura. Adecuada para exteriores porque ha sido tratada impregnando la madera en varias capas con pinturas especiales en tanques de color y pegando las partes de madera con cola marina especial. Herrajes de acero inoxidable AISI 316. Al ser de madera, se recomienda el mantenimiento con productos específicos para dicho material.

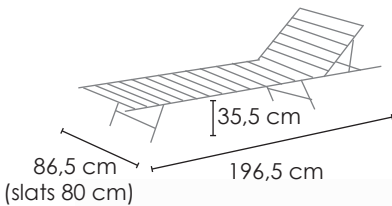
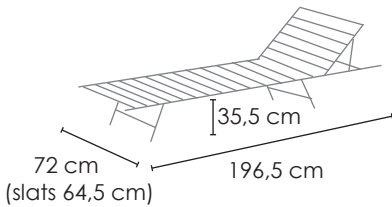

Materassino/Mattress/Matelas/Colchoneta  
10 cm

**COLORI LEGNO:**  
**WOOD COLORS:**  
**COULEURS DE BOIS:**  
**COLORES DE MADERA:**

BIANCO PIENO  
FULL WHITE  
BLANC PLEIN  
BLANCO SÓLIDO

SBIANCATO  
BLEACHED  
BLANCHI  
BLANQUEADO

NATURALE  
NATURAL  
NATUREL  
NATURAL

NOCE  
WALNUT  
NOYER  
NOGAL

MOGANO  
MAHOGANY  
ACAJOU  
CAOBA

NERO  
BLACK  
NOIR  
NEGRO

WENGÉ  
WENGÉ  
WENGÉ  
WENGÉ



6 POSIZIONI  
6 POSITIONS

6





# LETTINO LEGNO / WOODEN SUNBED TRANSAT EN BOIS / TUMBONA DE MADERA

misure/ sizes



L 191 cm  
P 61 cm  
Hs 40 cm



pieghevole  
folding  
pliable  
plegable



1 pz

L 165 cm  
P 75 cm  
H 9 cm  
Kg 15



20 pz

L 170 cm  
P 80 cm  
H 180 cm  
Kg 320

## OPZIONI / OPTIONS / OPTIONNEL / OPTIONES P.31:

Cuscino/Cushion/Coussin/Cojín  
50x25 cm, h 3 cm

Materassino/Mattress/Matelas/Colchoneta  
h 3-5 cm

- it / Lettino a 3 posizioni. Disponibile con o senza tettuccio parasole. Struttura in legno di frassino di prima qualità. 3 inclinazioni dello schienale. Con cordella. Adatto per l'esterno perchè trattato con impregnazione del legno a più mani con speciali vernici in vasche di colore e con incollaggio delle parti in legno tramite speciale colla marina. Ferramenta inox AISI 316. Essendo legno, si raccomanda una manutenzione con prodotti specifici per tale materiale.
- en / Sunbed 3 positions. Available with or without sunshield. With structure in first quality ash wood, with 3 inclinations of the backrest by cord. Suitable for outdoor use because it is treated with impregnation of the wood in several hands with special paints in color vats, and with gluing of the wooden parts using special marine glue. Hardware Inox AISI 316. Being wood, the maintenance with specific products for this material is recommended.
- fr / Transat 3 positions. Disponible avec ou sans pare-soleil. Structure en bois de frêne de haute qualité. 3 inclinaisons de dossier avec cordon. Idéal pour l'extérieur car il est traité avec une imprégnation du bois en plusieurs couches avec des peintures spéciales dans des baignoires avec couleur. Collage des parties en bois est réalisée à l'aide d'une colle marine spéciale. Quincaillerie en acier inoxydable AISI 316. Cependant, étant du bois, un entretien avec des produits spécifiques pour ce matériau est recommandé.
- es / Tumbona de 3 posiciones. Disponible con o sin parasol. Estructura de madera de fresno de primera calidad. Respaldo reclinable en 3 niveles diferentes. Sistema de cordón. Con colchoneta filtrante de 10 cm de altura. Adecuada para exteriores porque ha sido tratada impregnando la madera en varias capas con pinturas especiales en tanques de color y pegando las partes de madera con cola marina especial. Herrajes de acero inoxidable AISI 316. Al ser de madera, se recomienda el mantenimiento con productos específicos para dicho material.

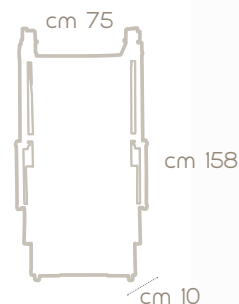

CHIUSO/CLOSED  
FERME/CERRADO

REGOLAZIONE SCHIENALE TRAMITE CORDELLA  
BACKREST ADJUSTMENT BY ROPE  
RÉGLAGE DU DOSSIER AVEC CORDON  
AJUSTE DEL RESPALDO MEDIANTE SISTEMA DE CORDÓN



## COLORI LEGNO: WOOD COLORS: COULEURS DE BOIS: COLORES DE MADERA:



BIANCO PIENO  
FULL WHITE  
BLANC PLEIN  
BLANCO SÓLIDO

SBIANCATO  
BLEACHED  
BLANCHI  
BLANQUEADO

NATURALE  
NATURAL  
NATUREL  
NATURAL

NOCE  
WALNUT  
NOYER  
NOGAL

MOGANO  
MAHOGANY  
ACAJOU  
CAOBA

NERO  
BLACK  
NOIR  
NEGRO

WENGÈ  
WENGÈ  
WENGÈ  
WENGÈ

3 POSIZIONI  
3 POSITIONS

3





misure/ sizes



L 47 cm  
P 114 cm  
H 108 cm  
Hs 30 cm



pieghevole  
folding  
pliable  
plegable



1 pz

L 140 cm  
P 61 cm  
H 4 cm  
Kg 7



30 pz

L 140 cm  
P 80 cm  
H 135 cm  
Kg 225

cm 61



cm 150

cm 5

CHIUSO/CLOSED  
FERMÉ/CERRADO

misure/ sizes



L 55 cm  
P 120 cm  
H 110 cm  
Hs 30 cm



pieghevole  
folding  
pliable  
plegable



1 pz

L 150 cm  
P 78 cm  
H 5 cm  
Kg 8,8



30 pz

L 150 cm  
P 80 cm  
H 165 cm  
Kg 225

cm 73



cm 150

cm 5

CHIUSO/CLOSED  
FERMÉ/CERRADO

**COLORI LEGNO:**  
**WOOD COLORS:**  
**COULEURS DE BOIS:**  
**COLORES DE MADERA:**

# SDRAIO LEGNO

## WOOD DECKCHAIR

### CHILIENNE EN BOIS

### TUMBONA DE MADERA



it / Sdraio con braccioli o senza braccioli in legno massello di frassino di primissima scelta, particolarmente adatto per esterni perché trattato con speciali vernici ed assemblato con l'incollaggio degli elementi tramite colla marina. Ferramenta inox AISI 316. Essendo legno, si raccomanda una manutenzione con prodotti specifici per tale materiale.

en / Deckchair with armrests or without armrests, with structure in first quality ash wood, suitable for outdoor use because it is treated with impregnation of the wood in several hands with special paints in color vats, and with gluing of the wooden parts using special marine glue, Hardware Inox AISI 316. Being wood, the maintenance with specific products for this material is recommended.

fr / Chilienne avec ou sans accoudoirs en bois de frêne de haute qualité, idéale pour l'extérieur car il est traité avec une imprégnation du bois en plusieurs couches avec des peintures spéciales dans des baignoires avec couleur. Collage des parties en bois est réalisée à l'aide d'une colle marine spéciale. Quincaillerie en acier inoxydable AISI 316. Cependant, étant du bois, un entretien avec des produits spécifiques pour ce matériau est recommandé.

es / Tumbona con reposabrazos o sin reposabrazos de madera maciza de fresno de primera calidad, especialmente indicada para su uso en exteriores porque está tratada con barnices especiales y se ensambla pegando los elementos con cola marina. Herrajes de acero inoxidable AISI 316. Al ser de madera, se recomienda el mantenimiento con productos específicos para dicho material.



BIANCO PIENO FULL WHITE PLEIN PLEIN BLANCO SOLIDO	SBIANCATO BLEACHED BLANCHI BLANQUEADO	NATURALE NATURAL NATUREL NATURAL	NOCE WALNUT NOYER NOGAL	MOGANO MAHOGANY ACAJOU CAOBA	NERO BLACK NOIR NEGRO	WENGÈ WENGÈ WENGÈ WENGÈ
--	--	---	----------------------------------	---------------------------------------	--------------------------------	----------------------------------





# MARINELLA LEGNO

## WOODEN MARINELLA

### MARINELLA EN BOIS

### MARINELLA DE MADERA

misure/ sizes



L 63,5 cm  
P 113 cm  
H 112,5 cm  
Hs 36 cm



pieghevole  
folding  
pliable  
plegable



1 pz

L 110 cm  
P 64 cm  
H 12,5 cm  
Kg 8,2



40 pz

L 120 cm  
P 120 cm  
H 190 cm  
Kg 340

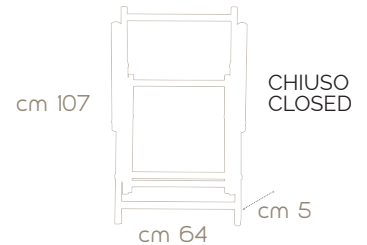

it / Sdraio con braccioli o senza braccioli in legno massello di frassino di primissima scelta, particolarmente adatto per esterni perché trattato con speciali vernici ed assemblato con l'incollaggio degli elementi tramite colla marina. Ferramenta inox AISI 316.

Essendo legno, si raccomanda una manutenzione con prodotti specifici per tale materiale.

en / Deckchair with armrests or without armrests, with structure in first quality ash wood, suitable for outdoor use because it is treated with impregnation of the wood in several hands with special paints in color vats, and with gluing of the wooden parts using special marine glue, Hardware Inox AISI 316. Being wood, the maintenance with specific products for this material is recommended.

fr / Chilienne avec ou sans accoudoirs en bois de frêne de haute qualité, idéale pour l'extérieur car il est traité avec une imprégnation du bois en plusieurs couches avec des peintures spéciales dans des baignoires avec couleur. Collage des parties en bois est réalisée à l'aide d'une colle marine spéciale. Quincaillerie en acier inoxydable AISI 316. Cependant, étant du bois, un entretien avec des produits spécifiques pour ce matériau est recommandé.

es / Tumbona con reposabrazos o sin reposabrazos de madera maciza de fresno de primera calidad, especialmente indicada para su uso en exteriores porque está tratada con barnices especiales y se ensambla pegando los elementos con cola marina. Herrajes de acero inoxidable AISI 316. Al ser de madera, se recomienda el mantenimiento con productos específicos para dicho material.

**COLORI LEGNO:**  
**WOOD COLORS:**  
**COULEURS DE BOIS:**  
**COLORES DE MADERA:**



BIANCO PIENO	SBIANCATO	NATURALE	NOCE	MOGANO	NERO	WENGÈ
FULL WHITE	BLEACHED	NATURAL	WALNUT	MAHOGANY	BLACK	WENGÈ
BLANC PLEIN	BLANCHI	NATUREL	NOYER	ACAJOU	NOIR	WENGÈ
BLANCO SÓLIDO	BLANQUEADO	NATURAL	NOGAL	CAOBA	NEGRO	WENGÈ

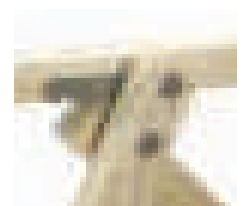

2 POSIZIONI  
2 POSITIONS

2



# LETTINI IN ALLUMINIO: LE MISURE ALUMINIUM SUNBEDS: THE SIZES TRANSAT EN ALUMINIUM : LES MESURES TUMBONAS DE ALUMINIO: LAS MEDIDAS

- \* Lettini per persone disabili h 50 cm
- \* Sunbeds for disabled people h 50 cm
- \* Transat pour personnes à mobilité réduite
- \* Tumbonas para personas con discapacidades

## STANDARD

BASE 3P

T3

T3 NEW

T4

KOMMODO

RICCIONE

RIO

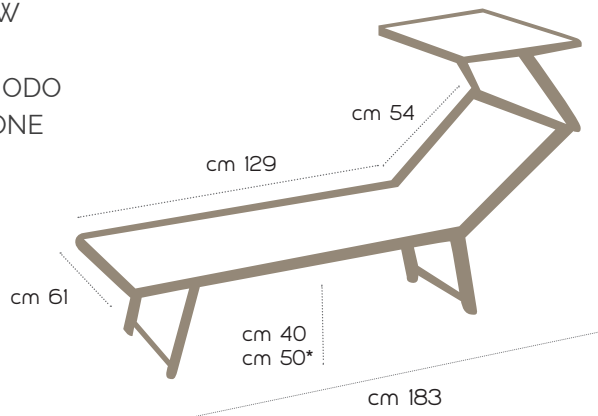

## EXTRALONG

BASE 3P

T3

T3 NEW

T4

KOMMODO

RICCIONE

RIO

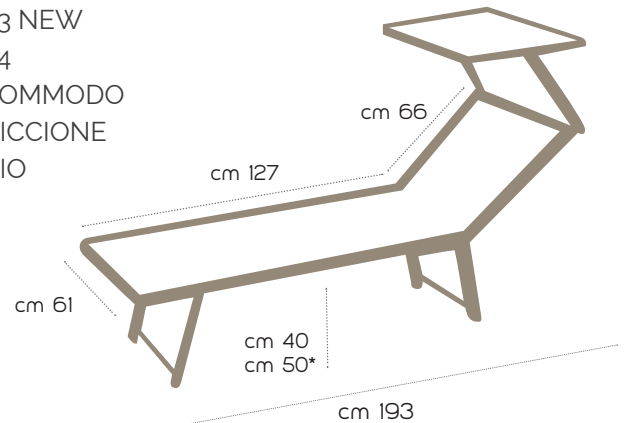

## MIAMI

T3

T3 NEW

T4

KOMMODO

RIO

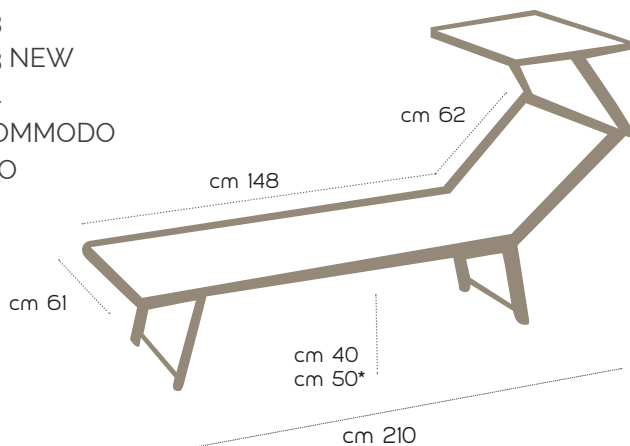

## KINGSIZE

RICCIONE

RIO

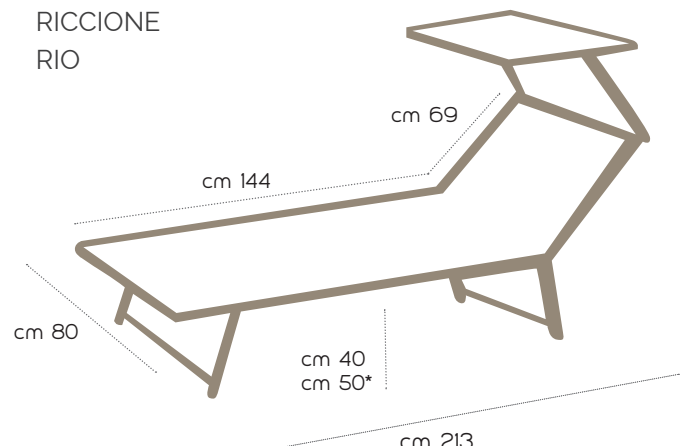

## STANDARD

BASE 3P

T3

T3NEW

T3NEW

T3NEW

T3NEW

T3NEW

T3NEW

T3NEW

T3NEW

T3NEW

T3NEW

T3NEW

T3NEW

T3NEW

T3NEW

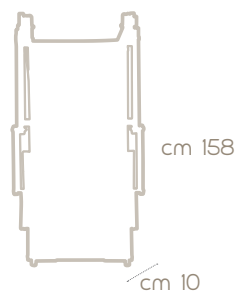

CHIUSO/CLOSED  
FERME/CERRADO

RICCIONE

5 STELLE

5 STELLE

5 STELLE

5 STELLE

5 STELLE

5 STELLE

5 STELLE

5 STELLE

5 STELLE

5 STELLE

5 STELLE

5 STELLE

5 STELLE

5 STELLE

5 STELLE

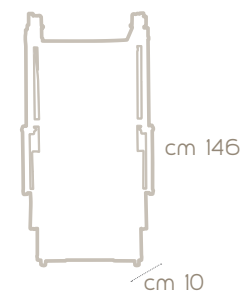

CHIUSO/CLOSED  
FERME/CERRADO

## KING SIZE

RICCIONE

RIO

RIO

RIO

RIO

RIO

RIO

RIO

RIO

RIO

RIO

RIO

RIO

RIO

RIO

RIO

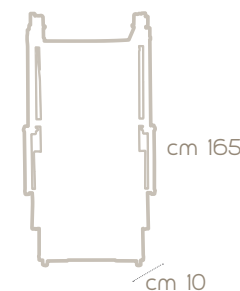

CHIUSO/CLOSED  
FERME/CERRADO



- it / I lettini **Riccione e Rio** possono essere richiesti in **versione King Size**. Disponibili con tessuti COR o RAM.  
en / The sunbeds **Riccione and Rio** can be ordered in "**King Size**" version. Available with fabrics COR or RAM.  
fr / Les transats **Riccione et Rio** peuvent être demandés dans la **version King Size**. Disponible avec les tissus COR ou RAM.  
es / Las tumbonas **Riccione y Rio** pueden pedirse en **tamaño King Size**. Disponible con tejidos COR o RAM.



- it / Tutti i lettini possono essere richiesti **con o senza tettuccio parasole**.  
en / All sunbeds can be requested **with or without the sunshield**.  
fr / Tous les transats peuvent être demandés **avec ou sans pare-soleil**.  
es / Todas las tumbonas pueden pedirse **con o sin parasol**.

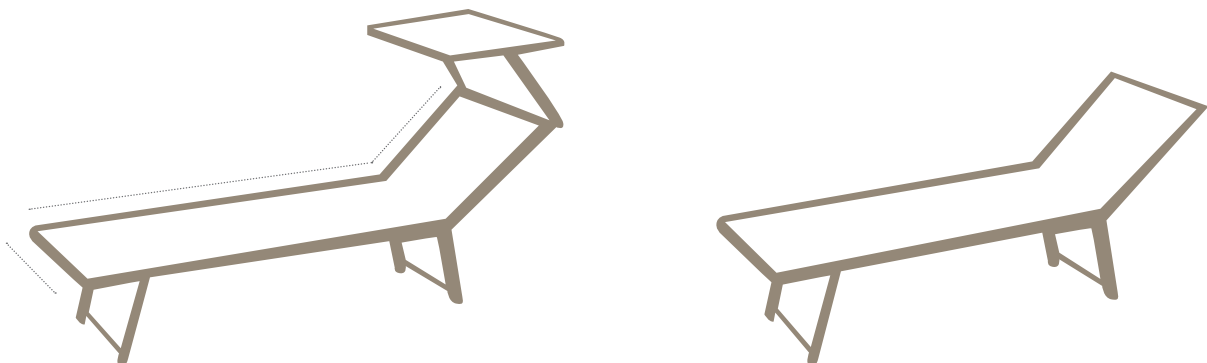



## ALLUMINIO / ALUMINIUM / ALUMINIUM / ALUMINIO

- it / I nostri lettini, sdraio e sedute sono costruiti con **alluminio di prima scelta**. Grazie allo speciale trattamento di anodizzazione a cui sono sottoposti, è garantita una perfetta inalterabilità anche nelle peggiori condizioni d'uso. Tutta la ferramenta è in acciaio **inox AISI 316**. L'alluminio dei nostri articoli può essere richiesto nelle seguenti colorazioni:
- en / Our sunbeds, deckchairs, and seats, are manufactured **with first choice aluminum**. Thanks to the special anodizing treatment to which they are subjected, the perfect inalterability is guaranteed even in the worst conditions of use. Hardware **inox AISI 316**. The aluminum of our items can be requested in the following colors:
- fr / Nos transats, chaises, et sièges, sont construits avec de **l'aluminium de premier choix**. Le traitement spécial d'anodisation auquel ils sont soumis garantit une parfaite inaltérabilité même dans les pires conditions d'utilisation. Toute la quincaillerie est en **acier inoxydable AISI 316**. L'aluminium de nos articles peut être demandé dans les couleurs suivantes:
- es / Nuestras tumbonas y sillas son de **aluminio de alta calidad**. Gracias al tratamiento especial de anodización al que se someten, se garantiza una perfecta inalterabilidad incluso en las peores condiciones de uso. Todos los herrajes son de **acero inoxidable AISI 316**. El aluminio de nuestros artículos puede pedirse en los siguientes colores:

ANODIZZATO  
ANODIZED  
ANODISÉ  
ANODIZADOArgento  
Silver  
Argent  
PlateadoBronzo-Oro  
Bronze-Gold  
Bronze-Or  
Bronce-Oro

Champagne

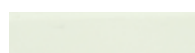
VERNICIATO  
POWDER COATED  
PEINT AVEC DES POUDRE ÉPOXY  
PINTADOBianco  
White  
Blanc  
BlancoAntracite  
Athracite  
Athracite  
AntracitaNero  
Black  
Noir  
Negro

- it / Per quantitativi possono essere fornite colorazioni particolari su richiesta del cliente.  
**La produzione di serie dell'alluminio è anodizzato color argento.**  
Per coloriture diverse, è necessaria una prenotazione con largo anticipo sui tempi di consegna.  
Tutti i nostri lettini sono dotati del **sistema SICURBLOCK** sostitutivo delle staffe e collaudato da decenni.
- en / For large quantities, special colors can be supplied upon request of the customer.  
**The series production of aluminum is in silver anodized.** For any other color, the order is required well in advance compared to the standard delivery time.  
All our sunbeds are equipped with the **SICURBLOCK system** which replaces the brackets and has been tested for decades.
- fr / Pour quantités, des couleurs spéciales peuvent être fournies sur demande du client.  
**La finition standard de l'aluminium est l'anodisé argent.**  
Pour finitions différentes, une réservation est nécessaire bien avant les délais de livraison standard.  
Tous nos transats sont équipés du **système SICURBLOCK** qui remplace les supports, et a été testé pendant des décennies.
- es / Para las cantidades, se pueden suministrar colores especiales a petición del cliente.  
**La producción de serie del aluminio es anodizado color plateado.**  
Para colores diferentes, hay que reservar con mucha antelación.  
Todas nuestras tumbonas están equipadas con el sistema de sustitución de **soportes SICURBLOCK**, que ha sido probado durante décadas.

ANODIZZATO ARGENTO  
ANODIZED SILVER  
ARGENT ANODISÉ  
ANODIZADO PLATEADOVERNICIATO BIANCO  
WHITE POWDER COATED  
BLANC PEINT AVEC DES POUDRE ÉPOXY  
PINTADO BLANCO



 misure/ sizes



vedi pagina 19  
see page 19  
voir page 19  
ver página 19



pieghevole  
folding  
pliable  
plegable



1 pz

L 160 cm  
P 76 cm  
H 11 cm  
Kg 12



25 pz

L 160 cm  
P 80 cm  
H 205 cm  
Kg 285

## BASE 3P

it / Lettino a 3 posizioni, con cordella. L'ultima inclinazione permette un allineamento totalmente orizzontale del lettino, rendendo possibile una confortevole posizione supina. Disponibile con o senza tettuccio parasole. Ferramenta inox AISI 316.

en / Sunbed with 3 inclinations of the backrest. The last inclination allows a totally horizontal alignment of the sunbed, making possible a comfortable supine position. Available with or without sunshield. Hardware Inox AISI 316.

fr / Transat à 3 positions, avec cordon. La dernière inclinaison permet un alignement totalement horizontal du transat permettant une position allongée confortable. Disponible avec ou sans pare-soleil. Quincaillerie en acier inoxydable AISI 316.

es / Tumbona de 3 posiciones, con cordón. La última inclinación permite una alineación totalmente horizontal de la tumbona, haciendo posible una cómoda posición supina. Disponible con o sin parasol. Herrajes de acero inoxidable AISI 316.

### OPZIONI / OPTIONS / OPTIONNEL / OPTIONES P.31:

Cuscino/Cushion/Coussin/Cojín  
50x25 cm, h 3 cm

Materassino/Mattress/Matelas/Colchoneta  
180x60, 190x60, 180x80 cm / h 3-5 cm

REGOLAZIONE SCHIENALE TRAMITE CORDELLA  
BACKREST ADJUSTMENT BY ROPE  
RÉGLAGE DU DOSSIER AVEC CORDON  
AJUSTE DEL RESPALDO MEDIANTE SISTEMA DE CORDÓN



3 POSIZIONI  
3 POSITIONS

**3**



 misure/ sizes



vedi pagina 19  
see page 19  
voir page 19  
ver página 19



pieghevole  
folding  
pliable  
plegable



1 pz

L 160 cm  
P 76 cm  
H 11 cm  
Kg 12



25 pz

L 160 cm  
P 80 cm  
H 205 cm  
Kg 285

# T3

it / Lettino a 3 posizioni con cordella. L'ultima inclinazione permette un allineamento totalmente orizzontale del lettino, rendendo possibile una confortevole posizione supina. Disponibile con o senza tettuccio parasole. Ferramenta inox AISI 316.

en / Traditional sunbed with 3 inclinations of the backrest, with rope. The third inclination allows a totally horizontal alignment of the sunbed, making possible a comfortable supine position. Available with or without sunshield. Hardware Inox AISI 316.

fr / Transat à 3 positions, avec cordon. La dernière inclinaison permet un alignement totalement horizontal du transat, permettant une position allongée confortable. Disponible avec ou sans pare-soleil. Quincaillerie en acier inoxydable AISI 316.

es / Tumbona de 3 posiciones con cordón. La última inclinación permite una alineación totalmente horizontal de la tumbona, haciendo posible una cómoda posición supina. Disponible con o sin parasol. Herrajes de acero inoxidable AISI 316.

## OPZIONI / OPTIONS / OPTIONNEL / OPTIONES P.31:

Cuscino/Cushion/Coussin/Cojín  
50x25 cm, h 3 cm

Materassino/Mattress/Matelas/Colchoneta  
180x60, 190x60, 180x80 cm / h 3-5 cm

Ruote/Wheels/Roulettes/Ruedas

REGOLAZIONE SCHIENALE TRAMITE CORDELLA  
BACKREST ADJUSTMENT BY ROPE  
RÉGLAGE DU DOSSIER AVEC CORDON  
AJUSTE DEL RESPALDO MEDIANTE SISTEMA DE CORDÓN



3 POSIZIONI  
3 POSITIONS

**3**





 misure/ sizes



vedi pagina 19  
see page 19  
voir page 19  
ver página 19



pieghevole  
folding  
pliable  
plegable



1 pz

L 160 cm  
P 76 cm  
H 11 cm  
Kg 12



25 pz

L 160 cm  
P 80 cm  
H 205 cm  
Kg 285

**OPZIONI / OPTIONS /  
OPTIONNEL / OPTIONES P.31:**

Cuscino/Cushion/Coussin/Cojín  
50x25 cm, h 3 cm

Materassino/Mattress/Matelas/Colchoneta  
180x60, 190x60, 180x80 cm / h 3-5 cm

Ruote/Wheels/Roulettes/Ruedas

# T4

it / Lettino a 4 posizioni dello schienale con cordella. La prima posizione consente di erigere lo schienale ad angolo retto e permette all'utilizzatore di sedersi comodamente appoggiando la schiena a mò di poltroncina. L'ultima inclinazione permette un allineamento totalmente orizzontale del lettino, rendendo possibile una confortevole posizione supina. Disponibile con o senza tettuccio parasole. Ferramenta inox AISI 316.

en / Sunbed with 4 inclinations of the backrest, with rope. The first inclination allows the backrest to be erected at a right angle and allows the user to sit comfortably leaning his back as a kind of armchair. The fourth inclination allows a totally horizontal alignment of the sunbed, making possible a comfortable supine position. Available with or without sunshield. Hardware Inox AISI 316.

fr / Transat à 4 positions, avec cordon. La première position permet de redresser le dossier à angle droit et permet à l'utilisateur de s'asseoir confortablement en adossant son dos comme un fauteuil. Avec la dernière position, il y a un alignement parfait du dossier avec le reste du transat, ce qui permet une position couchée confortable. Disponible avec ou sans pare-soleil. Quincaillerie en acier inoxydable AISI 316.

es / Tumbona con respaldo de 4 posiciones con cordón. La primera posición permite levantar el respaldo en ángulo recto y que el usuario pueda sentarse cómodamente con la espalda apoyada como si fuera un sillón. En la última posición, el respaldo está perfectamente alineado con el resto de la tumbona, lo que hace posible una cómoda posición supina. Disponible con o sin parasol. Herrajes de acero inoxidable AISI 316.

REGOLAZIONE SCHIENALE TRAMITE CORDELLA  
BACKREST ADJUSTMENT BY ROPE  
RÉGLAGE DU DOSSIER AVEC CORDON  
AJUSTE DEL RESPALDO MEDIANTE SISTEMA DE CORDÓN



4 POSIZIONI  
4 POSITIONS





 misure/ measures



vedi pagina 19  
see page 19  
voir page 19  
ver página 19



pieghevole  
folding  
pliable  
plegable



1 pz

L 160 cm  
P 76 cm  
H 11 cm  
Kg 12



23 pz

L 160 cm  
P 80 cm  
H 205 cm  
Kg 260

**OPZIONI / OPTIONS /  
OPTIONNEL / OPTIONES P.31:**

Cuscino/Cushion/Coussin/Cojín  
50x25 cm, h 3 cm

Materassino/Mattress/Matelas/Colchoneta  
180x60, 190x60, 180x80 cm / h 3-5 cm

Ruote/Wheels/Roulettes/Ruedas

# T3 NEW

it / Lettino con 3 posizioni dello schienale con meccanismo salvadita. L'ultima inclinazione permette un allineamento totalmente orizzontale del lettino, rendendo possibile una confortevole posizione supina. Disponibile con o senza tettuccio parasole. Ferramenta inox AISI 316.

en / Sunbed with 3 inclinations of the backrest with finger guard system. The third inclination renders the sun lounger fully horizontal. Available with or without sunshield. Hardware Inox AISI 316.

fr / Transat à 3 positions avec système de protège-doigts. La dernière inclinaison permet un alignement totalement horizontal du transat, permettant une position allongée confortable. Disponible avec ou sans pare-soleil. Quincaillerie en acier inoxydable AISI 316.

es / Tumbona con respaldo ajustable en 3 posiciones con mecanismo protector de dedos. La última inclinación permite una alineación totalmente horizontal de la tumbona, haciendo posible una cómoda posición supina. Disponible con o sin parasol. Herrajes de acero inoxidable AISI 316.

**REGOLAZIONE SCHIENALE CON MECCANISMO SENZA CORDELLA**

BACKREST ADJUSTMENT WITH ROPELESS MECHANISM  
RÉGLAGE DU DOSSIER AVEC MÉCANISME SANS CORDON  
AJUSTE DEL RESPALDO CON MECANISMO SIN CORDÓN



MECCANISMO SALVADITA  
FINGER GUARD SYSTEM  
SYSTÈME DE PROTÈGE-DOIGTS  
SISTEMA DE PROTECCIÓN DE DEDOS



3 POSIZIONI  
3 POSITIONS

**3**



 misure/ sizes



vedi pagina 19  
see page 19  
voir page 19  
ver página 19



pieghevole  
folding  
pliable  
plegable



1 pz

L 160 cm  
P 76 cm  
H 11 cm  
Kg 12



25 pz

L 160 cm  
P 80 cm  
H 205 cm  
Kg 285

**OPZIONI / OPTIONS /  
OPTIONNEL / OPTIONES P.31:**

Cuscino/Cushion/Coussin/Cojín  
50x25 cm, h 3 cm

Materassino/Mattress/Matelas/Colchoneta  
180x60, 190x60, 180x80 cm / h 3-5 cm

Ruote/Wheels/Roulettes/Ruedas

# KOMMODO

it / Lettino con meccanismo salvadita che permette 4 diverse posizioni dello schienale rimanendo comodamente distesi sul lettino. E' possibile, infatti, agire sulle manopole di cui il lettino è provvisto, per posizionare lo schienale nella maniera desiderata. Disponibile con o senza tettuccio parasole. Ferramenta inox AISI 316.

en / Sunbed with finger guard system that allows 4 different positions of the backrest while remaining comfortably lying on the sunbed. It is possible, in fact, to act on the levers with which the sunbed is provided to position the backrest in the desired one. Available with or without sunshield. Hardware Inox AISI 316.

fr / Transat avec système de protège-doigts qui permet 4 positions différentes du dossier tout en restant confortablement allongé sur le transat, car il est possible d'agir sur les molettes dont le transat est équipé, pour régler le dossier de la manière souhaitée. Disponible avec ou sans pare-soleil. Quincaillerie en acier inoxydable AISI 316.

es / Tumbona con mecanismo protector de dedos con respaldo ajustable en 4 posiciones diferentes mientras se está cómodamente tumbado en la misma. De hecho, es posible actuar sobre los pomos con los que está equipada la tumbona para colocar el respaldo de la manera deseada. Disponible con o sin parasol. Herrajes de acero inoxidable AISI 316.

REGOLAZIONE SCHIENALE CON MECCANISMO SENZA CORDELLA

BACKREST ADJUSTMENT WITH ROPELESS MECHANISM

RÉGLAGE DU DOSSIER AVEC MÉCANISME SANS CORDON

AJUSTE DEL RESPALDO CON MECANISMO SIN CORDÓN



MECCANISMO SALVADITA  
FINGER GUARD SYSTEM  
SYSTÈME DE PROTÈGE-  
DOIGTS  
SISTEMA DE PROTECCIÓN  
DE DEDOS



4 POSIZIONI  
4 POSITIONS

4



 misure/ sizes



vedi pagina 19  
see page 19  
voir page 19  
ver página 19



pieghevole  
folding  
pliable  
plegable



1 pz

L 160 cm  
P 76 cm  
H 11 cm  
Kg 12



25 pz

L 160 cm  
P 80 cm  
H 205 cm  
Kg 285

**OPZIONI / OPTIONS /  
OPTIONNEL / OPTIONES P.31:**

Cuscino/Cushion/Coussin/Cojin  
50x25 cm, h 3 cm

Materassino/Mattress/Matelas/Colchoneta  
180x60, 190x60, 180x80 cm / h 3-5 cm

Ruote/Wheels/Roulettes/Ruedas

# RICCIONE

it / Lettino con meccanismo salvadita a cremagliera, con 4 posizioni dello schienale. L'ultima inclinazione permette un allineamento totalmente orizzontale del lettino. Disponibile con o senza tettuccio parasole. Ferramenta inox AISI 316.

en / Sunbed with save finger rack mechanism that allows to adjust 4 different backrest positions for maximum comfort. Starting from the horizontal position, it is possible to choose the other three by simply raising the backrest. Available with or without sunshield. Hardware Inox AISI 316.

fr / Transat avec 4 positions de dossier, avec mécanisme à crémaillère, avec système de protégé-dozigts, avec la dernière inclinaison qui permet un alignement totalement horizontal du transat. Disponible avec ou sans pare-soleil. Quincaillerie en acier inoxydable AISI 316.

es / Tumbona con respaldo ajustable en 4 posiciones mediante mecanismo de cremallera con mecanismo protector de dedos. La última inclinación permite una alineación totalmente horizontal de la tumbona. Disponible con o sin parasol. Herrajes de acero inoxidable AISI 316.

REGOLAZIONE SCHIENALE CON MECCANISMO SENZA CORDELLA  
BACKREST ADJUSTMENT WITH ROPELESS MECHANISM  
RÉGLAGE DU DOSSIER AVEC MÉCANISME SANS CORDON  
AJUSTE DEL RESPALDO CON MECANISMO SIN CORDÓN



CARTER SALVADITA  
MECCANISMO  
A CREMAGLIERA

CARTER SAVE FINGERS  
ROPELESS RACK  
MECHANISM

CARTER DE SÉCURITÉ  
MÉCANISME  
À CRÉMAILLÈRE

PROTECCIÓN DE DEDOS  
MECANISMO  
DE CREMALLERA



4 POSIZIONI  
4 POSITIONS

4



 misura/ sizes

 vedi pagina 19  
see page 19  
voir page 19  
ver página 19

 pieghevole  
folding  
pliable  
plegable

 L 160 cm  
P 76 cm  
H 11 cm  
Kg 12  
1 pz

 L 160 cm  
P 80 cm  
H 205 cm  
Kg 285  
25 pz

**OPZIONI / OPTIONS /  
OPTIONNEL / OPTIONS P.31:**

Cuscino/Cushion/Coussin/Cojín  
50x25 cm, h 3 cm

Materassino/Mattress/Matelas/Colchoneta  
180x60, 190x60, 180x80 cm / h 3-5 cm

Ruote/Wheels/Roulettes/Ruedas

# RIO

it / Lettino con 5 diverse posizioni dello schienale, con meccanismo salvadita a cremagliera, per un maggiore comfort. Partendo dalla posizione stesa è possibile scegliere le altre quattro alzando semplicemente lo schienale. Disponibile con o senza tettuccio parasole. Ferramenta inox AISI 316.

en / Sunbed with save finger rack mechanism that allows to adjust 5 different backrest positions for maximum comfort. Starting from the horizontal position, it is possible to choose the other four by simply raising the backrest. Available with or without sunshield. Hardware Inox AISI 316.

fr / 5 positions différentes du dossier avec mécanisme à crémaillère, avec système de protège-doigts, pour plus de confort. A partir de la position allongée, il est possible de choisir les quatre autres en relevant simplement le dossier. Disponible avec ou sans pare-soleil. Quincaillerie en acier inoxydable AISI 316.

es / Respaldo ajustable en 5 posiciones diferentes con mecanismo de cremallera, con mecanismo protector de dedos, para mayor comodidad. Partiendo de la posición tumbada, es posible elegir las otras cuatro simplemente levantando el respaldo. Disponible con o sin parasol. Herrajes de acero inoxidable AISI 316.

**REGOLAZIONE SCHIENALE CON MECCANISMO SENZA CORDELLA**

BACKREST ADJUSTMENT WITH ROPELESS MECHANISM  
RÉGLAGE DU DOSSIER AVEC MÉCANISME SANS CORDON  
AJUSTE DEL RESPALDO CON MECANISMO SIN CORDÓN



CARTER SALVADITA  
MECCANISMO  
A CREMAGLIERA  
  
CARTER SAVE FINGERS  
ROPELESS RACK  
MECHANISM

CARTER DE SÉCURITÉ  
MÉCANISME  
À CRÉMAILLÈRE  
  
PROTECCIÓN DE DEDOS  
MECANISMO  
DE CREMALLERA



5 POSIZIONI  
5 POSITIONS  
**5** 







 misure/ sizes

 vedi pagina 19  
see page 19  
voir page 19  
ver página 19

 pieghevole  
folding  
pliable  
plegable

 L 160 cm  
P 76 cm  
H 11 cm  
Kg 12  
1 pz

 L 160 cm  
P 80 cm  
H 205 cm  
Kg 285  
25 pz

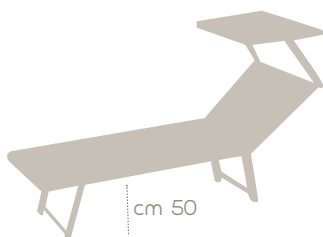

## LETTINI PER PERSONE DISABILI SUNBEDS FOR DISABLED PEOPLE TRANSATS POUR PERSONNES À MOBILITÉ RÉDUITE TUMBONAS PARA PERSONAS CON DISCAPACIDADES

it / I lettini T3, T4, T3 NEW, KOMMODO, RICCIONE, RIO possono essere richiesti con altezza seduta 50 cm.

en / The sunbeds models T3, T3 NEW, T4, KOMMODO, RICCIONE, RIO can be requested with a seat height of 50cm.

fr / Les transats T3, T4, T3 NEW, KOMMODO, RICCIONE, RIO peuvent être demandés avec une hauteur d'assise de 50 cm.

es / Las tumbonas T3, T4, T3 NEW, KOMMODO, RICCIONE, RIO se pueden pedir con una altura de asiento de 50 cm.



 misure/ sizes

 L 82 cm  
P 88 cm  
H 96 cm  
Hs 54 cm

 pieghevole  
folding  
pliable  
plegable

 L 89 cm  
P 31 cm  
H 123 cm  
Kg 19  
1 pz

## CARROZZINA MARE PER DISABILI BEACH WHEELCHAIR FAUTEUIL ROULANT DE PLAGE POUR PERSONNES À MOBILITÉ RÉDUITE SILLA DE RUEDAS DE PLAYA



it / Carrozzina da spiaggia a due ruote, ideale per lo spostamento sulla sabbia e per il bagno in mare con l'aiuto di un accompagnatore. Il telaio pieghevole è facile da trasportare e riporre quando non usato. Tessuto Romagna 861 e 862. Ferramenta inox AISI 316.

en / Two-wheeled beach wheelchair, ideal for moving on the sand and for swimming in the sea with the help of an accompanying person. The foldable frame is easy to carry and store when it not in use. Romagna tissue 861 and 862. Hardware Inox AISI 316.

fr / Fauteuil roulant de plage à deux roues, idéale pour se déplacer sur le sable, et se baigner dans la mer avec l'aide d'un compagnon. La structure pliable est facile à transporter et à ranger lorsque la fauteuil n'est pas utilisée. Tissus Romagna 861 et 862. Quincaillerie en acier inoxydable AISI 316.

es / Silla de ruedas de playa de dos ruedas, ideal para desplazarse por la arena y bañarse en el mar con la ayuda de un asistente. La estructura plegable es fácil de transportar y guardar cuando no se utiliza. Tejido Romagna 861 y 862. Herrajes de acero inoxidable AISI 316.

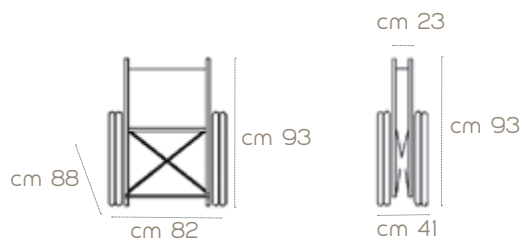

TESSUTI / FABRICS / TISSUS / TEJIDO



ROMAGNA 861



ROMAGNA 862



 misure/ measures

**3 cm**  
spessore cuscino  
cushion thickness  
épaisseur du coussin  
espesor del cojín

**3 - 5 - 10 cm**  
spessore materassino  
mattress thickness  
épaisseur du matelas  
espesor del colchoneta



L 160 cm  
P 76 cm  
H 11 cm  
Kg 10

2 pz (h 3-5 cm)



L 160 cm  
P 80 cm  
H 205 cm  
Kg 190

34 pz (5cm)



L 175 cm  
P 100 cm  
H 22 cm  
Kg 25

2 pz (10cm)



L 175 cm  
P 100 cm  
H 195 cm  
Kg 225

16 pz (10cm)



## CUSCINO E MATERASSINO FILTRANTI FILTERING CUSHION AND MATTRESS COUSSIN ET MATELAS FILTRANTS COJÍN Y COLCHONETA FILTRANTES

it / Materassino e cuscino realizzati con nostro tessuto.  
Interno composto da una struttura tridimensionale di fibre in pvc simile a un blocco di spaghetti di plastica bianca.  
Questo materiale consente di far filtrare l'acqua e di asciugarsi in brevissimo tempo.  
E' quindi possibile evitare di togliere il prodotto in caso di pioggia.  
Il trattamento antimuffa del tessuto garantisce una durata prolungata nel tempo.  
Completamente sfoderabile.  
Possibilità di personalizzazione del tessuto (con loghi o scritte).  
Colori disponibili: vedere cartella colori tessuto Milano  
Applicabile a tutti i modelli di lettino.

en / The mattress and cushion covers are made with our fabric, with the internal part composed of a three-dimensional structure of PVC white fibers, that allows the water to filter and dry in a very short time. It is therefore possible to avoid removing the mattress and the cushion when rain approaches. The anti-mold treatment of the fabric guarantees a prolonged duration over time.  
Fully removable.  
Possibility of customizing the fabric (with logos or writings).  
Available colors: see Milano fabrics color chart  
Applicable to all sunbed models.

fr / Matelas et coussin fabriqués avec notre tissu.  
Intérieur composé d'une structure tridimensionnelle de fibres de PVC blanc.  
Ce matériau permet à l'eau de filtrer et de sécher en très peu de temps.  
Il est ainsi possible d'éviter de retirer le produit en cas de pluie.  
Le traitement anti-moisissure du tissu garantit une durée prolongée dans le temps.  
Entièrement déhoussable.  
Possibilité de personnaliser le tissu ( avec logos ou écritures ).  
Coloris disponibles : voir nuancier tissu Milano  
Applicable sur tous les modèles de transat.

es / Colchoneta y cojín fabricados con nuestro tejido.  
Interior compuesto por una estructura tridimensional de fibras de pvc similar a un bloque de espaguetis de plástico blanco.  
Este material permite que el agua se filtre y se seque en muy poco tiempo.  
Por lo tanto, no es necesario retirar el producto en caso de lluvia.  
El tratamiento antimoho del tejido garantiza una larga duración.  
Forro totalmente desmontable.  
Posibilidad de personalizar el tejido (con logotipos o letras).  
Colores disponibles: véase la lista de colores del tejido de Milano.  
Applicable a todos los modelos de tumbona.





## RUOTE WHEELS ROULETTES RUEDAS



- it / Le ruote sono applicabili ai lettini (a parte il modello BASE) facilitandone lo spostamento, specialmente in aree Spa e piscine.
- en / The wheels can be applied to the sunbeds (a part the model BASE) facilitating their movement, especially in SPA areas and swimming pools.
- fr / Les roulettes peuvent être appliquées sur les transats (à l'exception du modèle BASE) facilitant leur déplacement, en particulier dans les espaces Spa et les piscines.
- es / Las ruedas se pueden acoplar a las tumbonas (aparte del modelo BASE), lo que facilita su desplazamiento, especialmente en las zonas de spa y piscina.

### misure/ measures

Lunghezza rocche:  
circa 500-600 metri  
Peso singola rocca:  
circa 1,5-2,5 Kg

Reel length:  
about 500-600 meters  
Single reel weight: approx.  
1.5-2.5 Kg

Longueur de bobine :  
environ 500-600 mètres  
Poids du colis unique :  
environ 1,5-2,5 kg

Longitud de la bobina:  
aproximadamente 500-600  
metros  
Peso de una bobina:  
aproximadamente 1,5-2,5 kg

## CORDELLE BRAIDED ROPES CORDONS CORDONES

- it / Treccia tonda 8 fili realizzata in filato di pvc proveniente dagli scarti di produzione che rimangono quando mettiamo a telaio il filo per produrre le tele dei lettini. Si può utilizzare, per esempio, per sostituire le obsolete cordelle bianche, abbinando le stesse al colore del telo del lettino. Disponibile in tante varianti di colori.
- en / Round 8-wire braid made of pvc yarn, coming from production waste, which remain when we loom the thread to produce the sunbed fabrics. It can be used, for example, to replace the obsolete white ropes, matching them to the color of the sunbed fabric. Available in many color variants.
- fr / Tresse ronde à 8 brins en fil de pvc provenant des déchets de production qui restent lorsque nous tissons le fil pour produire les toiles des transats. Il peut être utilisé, par exemple, pour remplacer les cordons blancs obsolètes, en les assortissant à la couleur de la toile du transat. Disponible dans de nombreuses variations de couleurs.
- es / Trenza redonda de 8 hilos fabricada con hilo de pvc procedente de los residuos de producción que nos sobran cuando tejemos el hilo para fabricar las telas de las tumbonas. Puede utilizarse, por ejemplo, para sustituir los obsoletos cordones blancos, haciéndolos coincidir con el color del tejido de la tumbona. Disponible en numerosas variaciones de color.



# LETTINO CANI

## DOGS SUNBED

### TRANSAT POUR CHIEN

### CAMA PARA PERROS



misure/ sizes



L 100 cm  
P 61 cm  
H 30 cm



pieghevole  
folding  
pliable  
plegable

it / Brandina per cani con telo in pvc e struttura super resistente in alluminio. Perfetto per far riposare il vostro cane rialzato da terra.

en / Dog sunbed with PVC fabric and super resistant aluminum structure. Perfect for resting your dog, raised off the ground.

fr / Transat pour chiens avec toile de PVC et structure en aluminium super résistant. Parfait pour faire reposer votre chien soulevé du sol.

es / Cama para perros con tela de PVC y estructura de aluminio extrarresistente. Perfecto para que su perro descansa elevado del suelo.

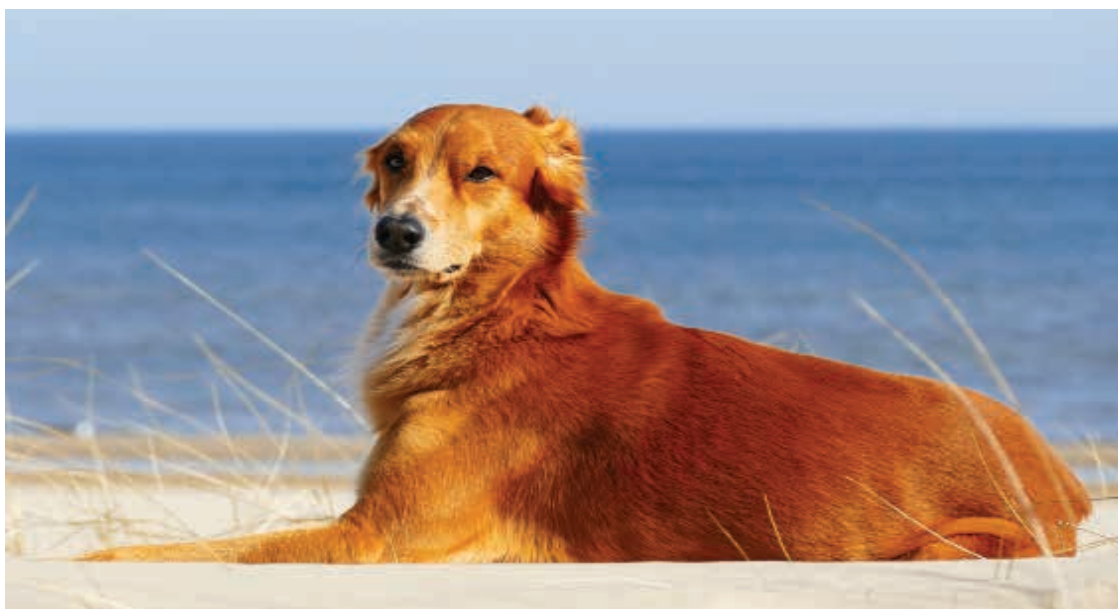



misure/ sizes

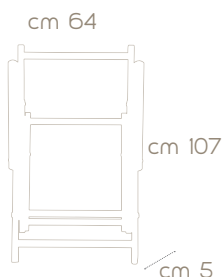
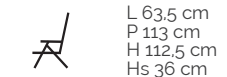

CHIUSO/CLOSED  
FERME/CERRADO

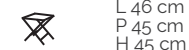

# MARINELLA e SGABELLO

it / Telaio in alluminio.  
Il telo viene fornito in tessuto plastificato PVC per un'ottima resistenza agli agenti atmosferici e per un facile lavaggio senza smontarlo dall'intelaiatura. Ferramenta inox AISI 316.

en / Aluminium frame.  
The fabrics is supplied in PVC plasticized material for excellent resistance to atmospheric agents, and for easy washing without removing it from the frame. Hardware Inox AISI 316

fr / Structure en aluminium.  
La toile est fourni en tissu PVC plastifié pour une excellente résistance aux agents atmosphériques et pour un lavage facile sans le retirer de la structure. Quincaillerie en acier inoxydable AISI 316.

es / Estructura de aluminio.  
La tela se suministra en tejido plastificado de PVC para una óptima resistencia a la intemperie y un fácil lavado sin necesidad de desmontarla de la estructura. Herrajes de acero inoxidable AISI 316.

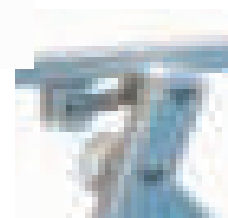

2 POSIZIONI  
2 POSITIONS

2



 misure/ sizes



L 107 cm  
P 58,5 cm  
Hs 30 cm



pieghevole  
folding  
pliable  
plegable



2 pz

L 160 cm  
P 76 cm  
H 11 cm  
Kg 15



60 pz

L 150 cm  
P 80 cm  
H 205 cm  
Kg 470

cm 58,5

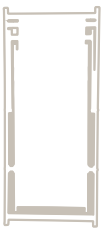

cm 138

CHIUSO/CLOSED  
FERMÉ/CERRADO

## SDRAIO SALVAMANI

SENZA BRACCIOLI  
DECKCHAIR WITHOUT ARMS  
CHILIENNE SANS ACCOUDOIRS  
TUMBONA SIN REPOSABRAZOS



it / Telaio in alluminio. Il telo viene fornito in tessuto plastificato PVC per un'ottima resistenza agli agenti atmosferici e per un facile lavaggio senza smontarlo dall'intelaiatura. Ferramenta inox AISI 316. GLI SDRAI VENGONO FORNITI CON LE TELE A PARTE, NON MONTATE.

en / Aluminum frame.  
The fabrics is supplied in PVC plasticized material for excellent resistance to atmospheric agents, and for easy washing without removing it from the frame. Hardware Inox AISI 316. THE DECKCHAIRS ARE SUPPLIED WITH THE FABRIC SEPARATELY, NOT ASSEMBLED.

fr / Structure en aluminium.  
La toile est fourni en tissu PVC plastifié pour une excellente résistance aux agents atmosphériques et pour un lavage facile sans le retirer de la structure. Quincaillerie en acier inoxydable AISI 316. LES CHILIENNES SONT FOURNIES AVEC LA TOILE SÉPARÉMENT, NON ASSEMBLÉES.

 misure/ sizes



L 114 cm  
P 68 cm  
Hs 30 cm



pieghevole  
folding  
pliable  
plegable



2 pz

L 160 cm  
P 76 cm  
H 11 cm  
Kg 16



60 pz

L 150 cm  
P 90 cm  
H 205 cm  
Kg 500

cm 68



cm 148

CHIUSO/CLOSED  
FERMÉ/CERRADO

## SDRAIO

CON BRACCIOLI  
DECKCHAIR WITH ARMS  
CHILIENNE AVEC ACCOUDOIRS  
TUMBONA CON REPOSABRAZOS



es / Estructura de aluminio. La tela se suministra en tejido plastificado de PVC para una óptima resistencia a la intemperie y un fácil lavado sin necesidad de desmontarla de la estructura. Herrajes de acero inoxidable AISI 316. LAS TUMBONAS SE SUMINISTRAN CON LOS TEJIDOS POR SEPARADO, SIN MONTAR.

3 POSIZIONI  
3 POSITIONS

3



Ombrelloni  
Parasols  
Parasols  
Sombrillas





# Tipologia di copertura per gli ombrelloni

## Cover versions for parasols

### Type de couverture pour parasols

### Tipo de cubierta de las sombrillas

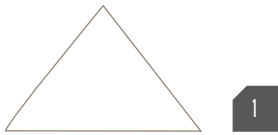

1

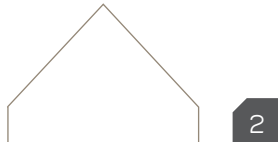

2

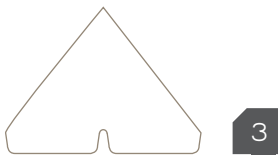

3

it / **Mantovana ombrelloni**

- 1 - senza mantovana
- 2 - una sola onda
- 3 - onde multiple

en / **Parasols valance**

- 1 - without valance
- 2 - with single wave valance
- 3 - Multiple wave

fr / **Cantonnère pour parasols**

- 1 - sans cantonnère
- 2 - avec une seule vague
- 3 - avec plusieurs vagues

es / **Sombrillas con volante**

- 1 - sin volante
- 2 - una onda
- 3 - múltiples ondas



it / Per zone esposte a vento di particolare intensità, gli ombrelloni possono essere richiesti con sfatatoio.

en/ For areas exposed to particularly intense wind, parasols can be supplied with the wind vent.

fr / Pour les zones exposées au vent d'une intensité particulière, les parasols peuvent être demandés avec l'évent.

es / Para las zonas expuestas a vientos especialmente fuertes, se pueden solicitar sombrillas con ventilación.

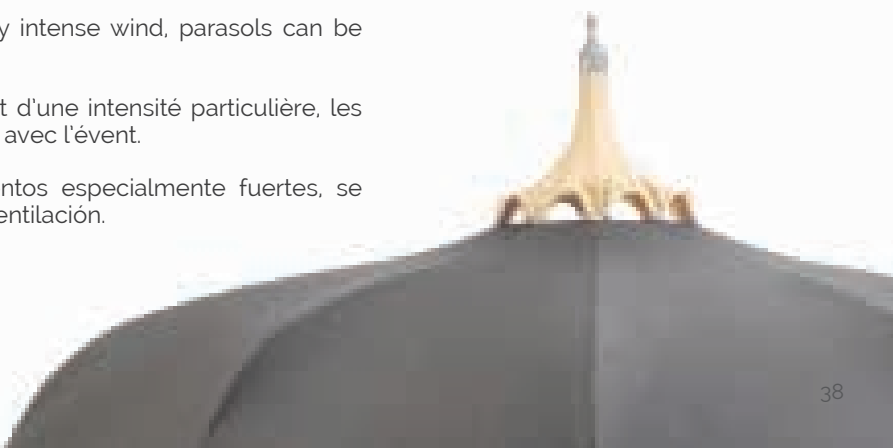



# Confezione Cover Couverture Cobertura

## it / COPERTURA

Tessuto acrilico 100% tinto in pasta di massima robustezza.

Il tessuto tinto in pasta offre UNA TENUTA DI COLORE ECCEZIONALE ANCHE DOPO UNA LUNGHISSIMA ESPOSIZIONE AL SOLE.

Tutte le coperture vengono confezionate con le cuciture di unione degli spicchi di tipo ZIG-ZAG a quattro fili con apposito cucirino imputrescibile.

## en / COVER

100% heavy duty paste-dyed acrylic fabric.

The paste-dyed fabric offers EXCEPTIONAL COLOR RETENTION EVEN AFTER A VERY LONG EXPOSURE TO SUNLIGHT for the union of the segments, all the covers are sewn with four-thread zigzag stitching, with a special rot-proof sewing thread.

Protective patch to avoid deterioration of the fabric is fixed with special nickel-plated brass eyelets

## fr / COUVERTURE

Tissu 100% acrylique teint dans la masse de résistance maximale.

Le tissu teint dans la masse offre une TENUE EXCEPTIONNELLE DE LA COULEUR MÊME APRÈS UNE TRÈS LONGUE EXPOSITION AU SOLEIL.

Toutes les couvertures sont fabriquées avec les coutures de jonction de type ZIG-ZAG à quatre fils avec un coudre spécial imputrescible.

## es / COBERTURA

Tejido 100 % acrílico teñido en pasta de máxima resistencia.

El tejido teñido en pasta ofrece UNA EXCEPCIONAL RESISTENCIA DEL COLOR INCLUSO TRAS UNA EXPOSICIÓN MUY PROLONGADA al sol.

Todas las cubiertas están fabricadas con costuras de unión de segmentos tipo ZIG-ZAG de cuatro hilos con hilo de coser especial resistente a la putrefacción.

VITE  
SCREW  
VIES  
TORNILLO

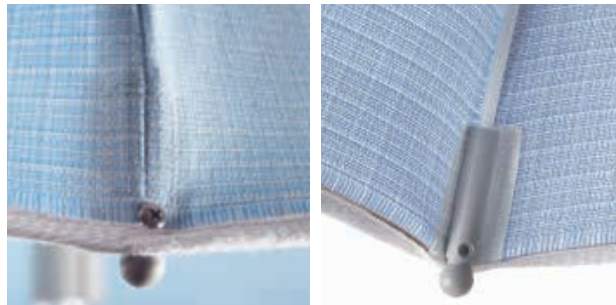

it / Nei nostri ombrelloni la copertura viene fissata ai terminali delle stecche con viti inox e con particolare rinforzo.

en / In our parasols, the cover is fixed to the ends of the ribs with stainless steel screws and with a particular reinforcement made by a nylon mold.

fr / Dans nos parasols, la couverture est fixée aux extrémités des baleines avec des vis en acier inoxydable et avec un renfort spécial.

es / En nuestros parasoles, la cubierta se fija a los extremos de los listones con tornillos de acero inoxidable y un refuerzo especial.

TASCA  
POCKET  
POCHE  
BOLSILLO

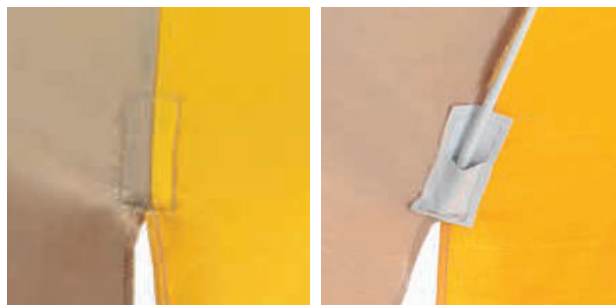

it / A richiesta la copertura viene fissata con rinforzo a forma di tasca contenente i terminali delle stecche.

en / On request and as an alternative to the above, the cover is made with reinforced pockets in which the ends of the ribs are inserted.

fr / Sur demande, la couverture peut être fixée avec un renfort en forme de poche contenant les extrémités des baleines.

es / Bajo solicitud, la cubierta se fija con un refuerzo en forma de bolsillo que contiene los extremos de los listones.



# RAGNI E STECCHE

## FRAME AND RIBS

### STRUCTURES ET BALEINES

#### ARAÑAS Y VARILLAS

mod.  
EGEO



n. 2

n. 3



n. 1

it / COLLANO (n.1), CORONA (n.2) E CAPPELOTTO (n.3)  
IN SPECIALE MATERIALE NYLON ANTIUSURA.

- 8 STECCHE IN ACCIAIO Ø 5 MM  
Misure: 90/8; 100/8; 110/8; 120/8; 130/8 cm  
Extra-pesanti con doppie protezioni mediante zincatura e successiva plastificazione con ribattini di congiunzione ai forcelloni in acciaio inox

- SISTEMA DI AGGANCIO:  
di tipo intercambiabile.

en / COLLAR (n.1), CROWN (n.2) AND CAP (n.3),  
IN MOLDS MADE WITH SPECIAL WEAR-RESISTANT  
NYLON MATERIAL

- 8 STEEL RIBS Ø 5 MM  
Measures: 90/8; 100/8; 110/8; 120; 130/8 cm  
in extra heavy steel and with double protection by galvanizing and subsequent powder coating with stainless steel rivets at the points of connection to the swingarms

- FASTENING SYSTEM:  
interchangeable type.

fr / COLLIER (n.1), COURONNE (n.2) ET CAPUCHON (n.3),  
DANS DES MOULES EN NYLON SPÉCIAL RÉSISTANT À  
L'USURE

- 8 BALEINES EN ACIER Ø 5 MM  
Mesures : 90/8; 100/8; 110/8; 120/8; 130/8 cm  
Extra-Lourd avec double protections au moyen de galvanisation et plastification ultérieure avec de la poudre époxy, et avec les rivets pour assembler les bras oscillants en acier inoxydable

- SYSTÈME D'ACCROCHAGE :  
de type interchangeable.

es / PIÑA CENTRAL (n.1), CORONA (n.2) Y TAPÓN (n.3)  
DE MATERIAL ESPECIAL DE NYLON RESISTENTE AL  
DESGASTE.

- 8 VARILLAS DE ACERO Ø 5 MM  
Medidas: 90/8; 100/8; 110/8; 120; 130/8 cm  
Extrapesados con doble protección mediante galvanizado y posterior plastificación con remaches de unión a las horquillas de acero inoxidable

- SISTEMA DE ACOPLAMIENTO:  
tipo intercambiabile.







mod.  
**IONIO**

- it / n. 4  
Toppa di protezione per evitare il deterioramento del tessuto.  
Fissate con particolari occhielli in ottone nichelato.
- en / Protective patch to avoid deterioration of the fabric is fixed with special nickel-plated brass eyelets.
- fr / Patches de protection pour éviter la détérioration du tissu. Fixés avec des œilletons spéciaux en laiton nickelé.
- es / Parche protector para evitar el deterioro del tejido. Se sujeta con ojales especiales de latón niquelado.



n. 4



n. 2



n. 3



n. 1



it / COLLANO (n.1), CORONA (n.2) E CAPPELOTTO (n.3)  
IN SPECIALE MATERIALE DI NYLON ANTIUSURA CON  
PULSANTE DI SBLOCCO

• 10 STECCHE IN ACCIAIO Ø 5 MM:

Misure: 90/10; 100/10; 110/10; 120/10; 130/10 cm

Extra-pesanti con doppia protezione mediante zincatura e successiva plastificazione, con ribattini di congiunzione ai forcelloni in acciaio inox.

**SISTEMA DI AGGANCIAMENTO:** di tipo intercambiabile.

Attaccapanni ed innovativo sistema salvadito incorporati nel collano.

en / COLLAR (n.1), CROWN (n.2) AND CAP (n.3) IN SPECIAL  
WEAR-RESISTANT NYLON MATERIAL WITH RELEASE  
BUTTON

• 10 RIBS IN STEEL Ø 5 MM:

Sizes: 90/10; 100/10; 110/10; 120/10; 130/10 cm

In extra heavy steel and with double protection by galvanizing and subsequent powder coating with stainless steel rivets at the points of connection to the swingarms.

**FASTENING SYSTEM:** interchangeable type, with clothes

hooks and innovative finger guard system incorporated in the collar.

fr / COLLIER (n.1), COURONNE (n.2) ET CAPUCHON (n.3)  
DANS DES MOULES EN NYLON SPÉCIAL RÉSISTANT À  
L'USURE, ET AVEC BOUTON DE DÉGAGEMENT

• 10 BALEINES EN ACIER Ø 5 MM

Mesures : 90/10; 100/10; 110/10; 120/10; 130/10 cm

Extra-Lourd avec double protections au moyen de galvanisation et plastification ultérieure avec de la poudre époxy, et avec les rivets pour assembler les bras oscillants en acier inoxydable.

**SYSTÈME D'ACCROCHAGE :** De type interchangeable.

Cintres et système innovant de protège-doigts incorporés dans le collier.

es / PIÑA CENTRAL (n.1), CORONA (n.2) Y TAPÓN (n.3)  
DE MATERIAL ESPECIAL DE NYLON RESISTENTE CON BOTÓN DE  
DESBLOQUEO

• 10 VARILLAS DE ACERO Ø 5 MM:

Medidas: 90/10; 100/10; 110/10; 120/10; 130/10 cm

Extrapesados con doble protección mediante galvanizado y posterior recubrimiento de plástico, con remaches que unen las horquillas de acero inoxidable.

**SISTEMA DE ACOPLAMIENTO :** tipo intercambiabile.

Ganchos para las toallas y un innovador sistema de protección de dedos en la piña central.

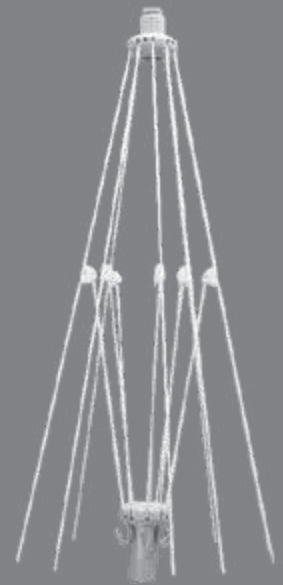



it / COLLANO, CORONA E CAPPELLOTTO IN SPECIALE MATERIALE DI NYLON ANTIUSURA CON PULSANTE DI SBLOCCO  
 • **8 STECCHE IN ACCIAIO Ø 5 MM:**  
 da 120 cm  
 Inserite in collano con sede specifica per creare uno spicchio intero ed uno mezzo.  
 Extra-pesanti con doppia protezione mediante zincatura e successiva plastificazione, con ribattini di congiunzione ai forcellini in acciaio inox.

en / COLLAR, CROWN AND CAP IN SPECIAL WEAR-RESISTANT PLASTIC WITH RELEASE BUTTON  
 • **8 STEEL RIBS Ø 5 MM:**  
 from cm 120  
 inserted into the collar in specific locations to create whole and half segments alternating between them,  
 in extra heavy steel and with double protection by galvanizing and subsequent powder coating with stainless steel rivets at the points of connection to the swingarms.

fr / COLLIER, COURONNE ET CAPUCHON, DANS DES MOULES EN NYLON SPÉCIAL RÉSISTANT À L'USURE, ET AVEC BOUTON DE DÉGAGEMENT  
 • **8 BALEINES EN ACIER Ø 5 MM**  
 de 120 cm de long  
 insérées dans le collier avec des positions spécifiques pour créer un segment entier et un demi-segment.  
 Extra-Long avec double protections au moyen de galvanisation et plastification ultérieure avec de la poudre époxy, et avec les rivets pour assembler les bras oscillants en acier inoxydable

es / PIÑA CENTRAL, CORONA Y TAPÓN DE MATERIAL ESPECIAL DE NYLON RESISTENTE CON BOTÓN DE DESBLOQUEO.  
 • **8 VARILLAS DE ACERO Ø 5 MM:**  
 de 120 cm  
 Introducidas en la piña central con alojamiento específico para crear un segmento entero y uno y medio.  
 Extrapesados con doble protección mediante galvanizado y posterior recubrimiento de plástico, con remaches que unen las horquillas de acero inoxidable.

mod.  
**BALTICO**



it / COLLANO, CORONA E CAPPELLOTTO IN SPECIALE MATERIALE DI NYLON ANTIUSURA CON PULSANTE DI SBLOCCO.  
 • **4 STECCHE o 8 STECCHE:** in alluminio  
 Attaccapanni ed innovativo sistema salvadito incorporati nel collano.

en / COLLAR, CROWN AND CAP MADE WITH SPECIAL WEAR-RESISTANT NYLON MATERIAL, WITH RELEASE BUTTON  
 • **4 OR 8 RIBS:** in aluminium  
 Clothes hooks and innovative finger guard system incorporated in the collar.

fr / COLLIER, COURONNE ET CAPUCHON, DANS DES MOULES EN NYLON SPÉCIAL RÉSISTANT À L'USURE, ET AVEC BOUTON DE DÉGAGEMENT  
 • **4 BALEINES OU 8 BALEINES:** en aluminium  
 Cintres et système innovant de protège-doigts incorporés dans le collier

es / PIÑA CENTRAL, CORONA Y TAPÓN DE MATERIAL ESPECIAL DE NYLON RESISTENTE CON BOTÓN DE DESBLOQUEO.  
 • **4 U 8 VARILLAS:** de aluminio  
 Ganchos para las toallas y un innovador sistema de protección de dedos en la piña central.

mod.  
**MAJESTIC**  
 MINI MAJESTIC  
 MAJESTIC 2  
 BIG MAJESTIC



**MINI MAJESTIC  
MAJESTIC 2**

Palo / Pole  
 Ø 40 mm

**Baionetta**

su richiesta: Eolo  
 on request: Eolo

**BIG MAJESTIC**

Palo / Pole  
 Ø 45 mm

**Eolo**

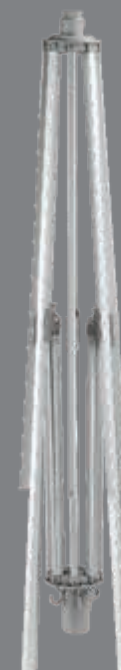



# TRADIZIONALE



1 pz

L 150 cm  
P 20 cm  
H 20 cm  
Kg 9

72 pz

L 150 cm  
P 120 cm  
H 110 cm  
Kg 590RAGNO  
FRAME  
STRUCTURE  
ARANAmod.  
EGEO  
IONIO

p.39-40

## it / SENZA MANTOVANA

- Tessuto acrilico: un tessuto per tutti i segmenti o due tessuti in tinta unita a spicchi alternati.
- Lunghezza stecche: 90; 100; 110; 120; 130 cm
- Bordino acrilico incluso, colore a scelta.
- Opzioni: Sfiatatoio.

## en / WITHOUT VALANCE

- Fabric: Acrylic: one fabric for all the segments, or two fabrics in solid color with alternating segments.
- Ribs length: 90; 100; 110; 120; 130 cm
- Acrylic edge in one color of your choice included.
- Optional: Wind Vent

## fr / SANS CANTONNIÈRE

- Tissu acrylique: un seul tissu pour tous les segments, ou deux tissus de couleur unie avec des segments alternés
- Longueur des baleines: 90; 100; 110; 120; 130 cm
- Bordure acrylique incluse, couleur au choix
- Optionnel: Évent

## es / SIN VOLANTES

- Tejido acrílico: un tejido para todos los segmentos o dos tejidos lisos en segmentos alternos.
- Longitud de la varilla: 90; 100; 110; 120; 130.
- Borde acrílico incluido, color a elegir.
- Opcional: Rejilla de ventilación.

## it / CON MANTOVANA A UNA ONDA

- Tessuto acrilico: un tessuto per tutti i segmenti o due tessuti in tinta unita a spicchi alternati.
- Lunghezza stecche: 90; 100; 110; 120; 130 cm
- Opzioni: Sfiatatoio
- Opzionale: Bordino acrilico
- Opzioni: Mantovana onde multiple

## en / WITH SINGLE WAVE VALANCE

- Fabric: Acrylic, one fabric for all the segments, or two fabrics in solid color with alternating segments
- Ribs length: 90; 100; 110; 120; 130 cm
- Optional: Wind Vent
- Optional: Acrylic edge in one color of your choice
- Optional: Multiple Waves

## fr / AVEC CANTONNIÈRE UNE VAGUE

- Tissu acrylique: un seul tissu pour tous les segments, ou deux tissus de couleur unie avec des segments alternés
- Longueur des baleines: 90; 100; 110; 120; 130 cm
- Optionnel: Évent.
- Optionnel: Bordure acrylique, couleur au choix
- Optionnel: Cantonnière avec plusieurs vagues

## es / CON VOLANTE DE UNA ONDA

- Tejido acrílico: un tejido para todos los segmentos o dos tejidos lisos en segmentos alternos.
- Longitud de la varilla: 90; 100; 110; 120; 130.
- Opcional: Rejilla de ventilación
- Opcional: Borde acrílico
- Opcional: Volante de ondas múltiples



## it / SFIATATOIO

- Tessuti a tinta unita.
- Bordino acrilico incluso, colore a scelta.

## fr / ÉVENT

- Tissus de couleur unie.
- Bordure acrylique incluse, couleur au choix.

## en / WIND VENT

- Fabric: Acrylic, available only with fabrics in solid color
- Acrylic edge in one color of your choice included.

## es / REJILLA DE VENTILACIÓN

- Tejidos de color liso.
- Borde acrílico incluido, color a elegir.



# PAGODINA

## it / SENZA MANTOVANA

- Tessuto acrilico: un tessuto per tutti i segmenti o due tessuti in tinta unita a spicchi alternati.
- Lunghezza stecche: 100; 110; 120; 130 cm
- Bordino acrilico incluso, colore a scelta.
- Opzioni: Sfiatatoio.

## en / WITHOUT VALANCE

- Fabric: Acrylic, one fabric for all the segments, or two plain colored fabrics and alternating segments
- Ribs length: 100; 110; 120; 130 cm
- Acrylic edge in one color of your choice included.
- Optional: Wind Vent.

## fr / SANS CANTONNIÈRE

- Tissu acrylique : un seul tissu pour tous les segments, ou deux tissus de couleur unie avec des segments alternés
- Longueur des baleines : 100 ; 110 ; 120 ; 130 cm
- Bordure acrylique incluse, couleur au choix
- Optionnel: Event.

## es / SIN VOLANTE

- Tejido acrílico: un tejido para todos los segmentos o dos tejidos lisos en segmentos alternos.
- Longitud de la varilla: 100; 110; 120; 130
- Borde acrílico incluido, color a elegir.
- Opcional: Rejilla de ventilación.



1 pz

L 150 cm  
P 25 cm  
H 25 cm  
Kg 9

55 pz

L 150 cm  
P 120 cm  
H 110 cm  
Kg 465RAGNO  
FRAME  
STRUCTURE  
ARAÑAmod.  
IONIO

p.40



## it / CON MANTOVANA A UNA ONDA

- Tessuto acrilico: un tessuto per tutti i segmenti o due tessuti in tinta unita a spicchi alternati.
- Lunghezza stecche: 100; 110; 120; 130 cm
- Bordino acrilico incluso.
- Opzioni: Mantovana onde multiple.

## en / WITH SINGLE WAVE VALANCE

- Fabric: Acrylic, one fabric for all the segments, or two fabrics in solid color with alternating segments
- Ribs length : 100; 110; 120; 130 cm
- Acrylic edge in one color of your choice included.
- Optional: Wind Vent
- Optional: Multiple Waves

## fr / AVEC CANTONNIÈRE UNE VAGUE

- Tissu acrylique : un seul tissu pour tous les segments, ou deux tissus de couleur unie avec des segments alternés
- Longueur des baleines : 100 ; 110 ; 120 ; 130 cm
- Bordure acrylique incluse, couleur au choix
- Optionnel: Event.
- Optionnel: Cantonnière avec plusieurs vagues

## es / CON VOLANTE DE UNA ONDA

- Tejido acrílico: un tejido para todos los segmentos o dos tejidos lisos en segmentos alternos.
- Longitud de la varilla: 100; 110; 120; 130
- Borde acrílico incluido.
- Opcional: Volante de ondas múltiples.

## it / SFIATATOIO

- Tessuti a tinta unita.
- Bordino acrilico incluso, colore a scelta.

## fr / ÉVENT

- Tissus de couleur unie.
- Bordure acrylique incluse, couleur au choix.

## en / WIND VENT

- Fabric: Acrylic, available only with fabrics in solid color.
- Acrylic edge in one color of your choice included.

## es / REJILLA DE VENTILACIÓN

- Tejidos de color liso.
- Borde acrílico incluido, color a elegir.





# PAGODA



1 pz

L 170 cm  
P 25 cm  
H 25 cm  
Kg 9

55 pz

L 170 cm  
P 120 cm  
H 110 cm  
Kg 465RAGNO  
FRAME  
STRUCTURE  
ARAÑAmod.  
**IONIO**

p.40

## it / CON MANTOVANA A UNA ONDA

- Tessuto acrilico: un tessuto per tutti i segmenti o due tessuti in tinta unita a spicchi alternati.
- Lunghezza stecche: ; 100; 110; 120; 130 cm
- Bordino acrilico incluso, colore a scelta.
- Opzioni: Sfiatatoio, Mantovana onde multiple

## en / WITH SINGLE WAVE VALANCE

- Fabric: Acrylic, one fabric for all the segments, or two plain colored fabrics and alternating segments
- Ribs length : 100; 110; 120; 130 cm
- Acrylic edge in one color of your choice included.
- Optional : Wind Vent, Multiple Waves

## fr / AVEC CANTONNIÈRE UNE VAGUE

- Tissu acrylique : un seul tissu pour tous les segments, ou deux tissus de couleur unie avec des segments alternés
- Longueur des baleines : 100 ; 110 ; 120 ; 130 cm
- Bordure acrylique incluse, couleur au choix
- Optionnel: Event, Cantonnière avec plusieurs vagues

## es / CON VOLANTE DE UNA ONDA

- Tejido acrílico: un tejido para todos los segmentos o dos tejidos lisos en segmentos alternos.
- Longitud de la varilla: ; 100; 110; 120; 130
- Borde acrílico incluido, color a elegir.
- Opcional: Rejilla de ventilación, Volante de ondas múltiples



## it / SFIATATOIO

- Tessuti a tinta unita.
- Bordino acrilico incluso, colore a scelta.

## fr / ÉVENT

- Tissus de couleur unie.
- Bordure acrylique incluse, couleur au choix

## en / WIND VENT

- Fabric: Acrylic, available only with plain colored fabrics.
- Acrylic edge in one color of your choice included.

## es / REJILLA DE VENTILACIÓN

- Tejidos de color liso.
- Borde acrílico incluido, color a elegir.





# TUKUL



1 pz

L 150 cm  
P 25 cm  
H 25 cm  
Kg 9



55 pz

L 150 cm  
P 120 cm  
H 110 cm  
Kg 465

RAGNO  
FRAME  
STRUCTURE  
ARAÑA

mod.  
**IONIO**

p.40



## it / CON FRANGIA

- Tessuto acrilico totalmente ricoperto con rafia sintetica
- Si può avere nei colori: bianco, beige, rosso, blu, verde e aragosta
- Lunghezza stecche: 90; 100; 110 cm

## en / WITH FRINGES

- Acrylic, fully covered with synthetic raffia with fringes
- Available in colours: white, beige, red, blue, green and orange
- Ribs length: 90; 100; 110 cm

## fr / AVEC FRANGES

- Tissu acrylique entièrement recouvert de raphia synthétique
- Disponible en couleurs : blanc, beige, rouge, bleu, vert et homard
- Longueur des baleines : 90 ; 100 ; 110 cm

## es / CON FLECOS

- Tejido acrílico totalmente recubierto de rafia sintética
- Disponible en los colores: blanco, beige, rojo, azul, verde y langosta
- Longitud de la varilla: 90/10; 100/10; 110/10

# BALTICO



1 pz

L 150 cm  
P 20 cm  
H 20 cm  
Kg 9



72 pz

L 150 cm  
P 120 cm  
H 110 cm  
Kg 590

RAGNO  
FRAME  
STRUCTURE  
ARAÑA

mod.  
**BALTICO**

p.41



## it / SENZA MANTOVANA

- Tessuto acrilico: un tessuto per tutti i segmenti o due tessuti in tinta unita a spicchi alternati.
- Misura: Ottagonale 190x190 cm
- Bordino acrilico incluso, colore a scelta.

## en / WITHOUT VALANCE

- Fabric: Acrylic, one fabric for all the segments, or two fabrics in solid color with alternating segments
- Measure: Octagonal 190X190 cm
- Acrylic edge in one color of your choice included

## fr / SANS CANTONNIÈRE

- Tissu acrylique : un seul tissu pour tous les segments, ou deux tissus de couleur unie avec des segments alternés
- Mesure : Octogonale 190x190 cm
- Bordure acrylique incluse, couleur au choix.

## es / SIN VOLANTE

- Tejido acrílico: un tejido para todos los segmentos o dos tejidos lisos en segmentos alternos.
- Medidas: Octagonal 190x190
- Borde acrílico incluido, color a elegir.

misure/ sizes

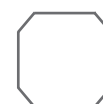

190x190 cm



# MINI MAJESTIC



RAGNO  
FRAME  
STRUCTURE  
ARAÑA

mod.  
**MAJESTIC**

p.41



it / **SENZA MANTOVANA**

- Ragno: Majestic, versione con 4 stecche.
- Tessuto acrilico: un tessuto per tutti i segmenti o due tessuti in tinta unita a spicchi alternati.
- Bordino acrilico incluso, colore a scelta.
- Opzioni: Sfiatatoio, Palo Ø 45 mm (Eolo)

en / **WITHOUT VALANCE**

- Frame: Majestic, version with 4 aluminium ribs
- Fabric: Acrylic, one fabric for all the segments, or two fabrics in solid color with alternating segments.
- Acrylic edge in one color of your choice included.
- Optional : Wind Vent, Pole Ø 45 mm (Eolo)

fr / **AVEC CANTONNIÈRE**

- Structure : Majestic, version à 4 baleines.
- Tissu acrylique : un seul tissu pour tous les segments, ou deux tissus de couleur unie avec des segments alternés
- Bordure acrylique incluse, couleur au choix.
- Optionnel: Event, Mât Ø 45 mm (Eolo)

es / **SIN VOLANTE**

- Araña: Majestic, versión de 4 varillas.
- Tejido acrílico: un tejido para todos los segmentos o dos tejidos lisos en segmentos alternos.
- Borde acrílico incluido, color a elegir.
- Opcional: Rejilla de ventilación, Mástil Ø 45 mm (Eolo)

misure/ sizes

200x200 cm

1 pz  
L 170 cm  
P 25 cm  
H 25 cm  
Kg 10

45 pz  
L 170 cm  
P 120 cm  
H 110 cm  
Kg 455





# MAJESTIC 2



RAGNO  
FRAME  
STRUCTURE  
ARAÑA

mod.  
**MAJESTIC**

p.41



- it / **CON MANTOVANA A ONDE MULTIPLE**
- Ragno: Majestic, versione con 8 stecche.
  - Tessuto acrilico: un tessuto per tutti i segmenti o due tessuti in tinta unita a spicchi alternati.
  - Sfiatatoio incluso.
  - Bordino acrilico incluso, colore a scelta.
  - **Opzioni: Palo Ø 45 mm (Eolo)**

- en / **WITH MULTIPLE WAVES VALANCE**
- Frame: Majestic, version with 8 aluminium ribs
  - Fabric: Acrylic, one fabric for all the segments, or two fabrics in solid color with alternating segments.
  - Wind Vent included
  - Acrylic edge in one color of your choice included
  - **Optional : Pole Ø 45 mm (Eolo)**

 misure/ sizes

 200x200 cm

- fr / **AVEC CANTONNIÈRE PLUSIEURS VAGUES**
- Structure : Majestic, version à 8 baleines.
  - Tissu acrylique : un seul tissu pour tous les segments, ou deux tissus de couleur unie avec des segments alternés
  - Évent inclus
  - Bordure acrylique incluse, couleur au choix.
  - **Optionnel: Mât Ø 45 mm (Eolo)**

- es / **CON VOLANTE DE ONDAS MÚLTIPLES**
- Araña: Majestic, versión de 8 varillas.
  - Tejido acrílico: un tejido para todos los segmentos o dos tejidos lisos en segmentos alternos.
  - Incluye rejilla de ventilación.
  - Borde acrílico incluido, color a elegir.
  - **Opcional: Mástil Ø 45 mm (Eolo)**



- it / **SENZA MANTOVANA**
- Ragno: Majestic, versione con 8 stecche.
  - Tessuto acrilico: un tessuto per tutti i segmenti o due tessuti in tinta unita a spicchi alternati.
  - Sfiatatoio incluso.
  - Bordino acrilico incluso, colore a scelta.
  - **Opzioni: Palo Ø 45 mm (Eolo)**

- en / **WITHOUT VALANCE**
- Frame: Majestic, version with 8 aluminium ribs
  - Fabric: Acrylic, one fabric for all the segments, or two fabrics in solid color with alternating segments
  - Wind Vent included
  - Acrylic edge in one color of your choice included.
  - **Optional : Pole Ø 45 mm (Eolo)**

 misure/ sizes

 Ø 240 cm  
Ø 280 cm

 200x200 cm

- fr / **AVEC CANTONNIÈRE**
- Structure : Majestic, version à 8 baleines.
  - Tissu acrylique : un seul tissu pour tous les segments, ou deux tissus de couleur unie avec des segments alternés
  - Évent inclus
  - Bordure acrylique incluse, couleur au choix.
  - **Optionnel: Mât Ø 45 mm (Eolo)**

- es / **SIN VOLANTE**
- Araña: Majestic, versión de 8 varillas.
  - Tejido acrílico: un tejido para todos los segmentos o dos tejidos lisos en segmentos alternos.
  - Incluye rejilla de ventilación.
  - Borde acrílico incluido, color a elegir.
  - **Opcional: Mástil Ø 45 mm (Eolo)**

 1 pz  
L 170 cm  
P 25 cm  
H 25 cm  
Kg 10

 45 pz  
L 170 cm  
P 120 cm  
H 110 cm  
Kg 455





# BIG MAJESTIC

RAGNO  
FRAME  
STRUCTURE  
ARAÑA

mod.  
**MAJESTIC**

p.41



misure/ sizes

Ø 250 cm  
Ø 280 cm  
Ø 300 cm

220x220 cm  
250x250 cm  
300x300 cm

300x300 cm  
H 285 cm  
palo unico/single pole  
mât unique/mástil único

Ø 300 cm  
H 200 cm +  
palo inferiore h 85 cm  
lower pole 85 cm  
mât inférieur 85 cm  
mástil inferior 85 cm

it / **SENZA MANTOVANA**

- Ragno: Big Majestic, versione con 8 stecche.
- Tessuto acrilico: un tessuto per tutti i segmenti o due tessuti in tinta unita a spicchi alternati.
- Palo superiore Ø 45 mm con spessore maggiorato. Fervento Eolo.
- Sfiatatoio incluso.
- Bordino acrilico incluso, colore a scelta.

en / **WITHOUT VALANCE**

- Frame: Big Majestic, version with 8 aluminium ribs
- Fabric: Acrylic, one fabric for all the segments, or two fabrics in solid color with alternating segments.
- Upper pole Ø 45 mm, with increased thickness. Version "Eolo" wind protection
- Wind Vent included
- Acrylic edge in one color of your choice included

fr / **SANS CANTONNIÈRE**

- Structure : Big Majestic, version à 8 baleines.
- Tissu acrylique : un seul tissu pour tous les segments, ou deux tissus de couleur unie avec des segments alternés
- Mât supérieur Ø 45 mm avec une épaisseur accrue. Avec coupe-vent Eolo.
- Évén inclus
- Bordure acrylique incluse, couleur au choix.

es/ **SIN VOLANTE**

- Araña: Big Majestic, versión con 8 varillas.
- Tejido acrílico: un tejido para todos los segmentos o dos tejidos lisos en segmentos alternos.
- Mástil superior de Ø 45 mm con mayor espesor. Con caperuza antiviento Eolo.
- Incluye rejilla de ventilación.
- Borde acrílico incluido, color a elegir.

Ø 280 cm - 220 x 220 cm

L 170 cm  
P 25 cm  
H 25 cm  
Kg 10

L 170 cm  
P 120 cm  
H 110 cm  
Kg 455

Ø 300 cm

L 210 cm  
P 30 cm  
H 30 cm  
Kg 11

L 210 cm  
P 120 cm  
H 110 cm  
Kg 460

300 x 300 cm

L 310 cm  
P 30 cm  
H 30 cm  
Kg 13

L 210 cm  
P 120 cm  
H 110 cm  
Kg 540







# PALI DELL'OMBRELLONE PARASOL POLES MÂTS DE PARASOL MÁSTILES DE LA SOMBRILLA

it / Alluminio con anodizzazione anticorrosione.  
Ø 40 mm  
**I pali standard non sono inclinabili.** Solo su richiesta possono essere muniti di **snodo per inclinazione**.

I pali possono essere forniti nella **versione a Baionetta o Eolo**.

**Baionetta** lascia all'ombrellone la possibilità di ruotare e non danneggiare le stecche in caso di vento particolarmente insistente.

E' possibile aggiungere il Blocca Ombrellone ( vedi pagina successiva ).

**Eolo** fissa il palo superiore e inferiore tramite una vite.

en / Aluminum with anti-corrosion anodizing.  
Ø 40 mm  
**Standard pole are not tiltable.** On request they can be equipped with a **joint for the inclination** of the cover.

The poles can be supplied with the Bayonet or Eolo couplings.

The **Bayonet** coupling leaves to the parasol the possibility to rotate and not damage the ribs in the event of particularly strong wind.

It is possible to add the Parasol Lock ( see next page ).

The **Eolo** coupling fixes the upper and lower poles with a screw.

fr / Aluminium avec anodisation anti-corrosion.  
Ø 40mm  
**Les mâts en standard ne sont pas inclinables.** Sur demande, ils peuvent être équipés d'un **joint d'inclinaison**.

Les mâts peuvent être fournis avec les accouplements à Baïonnette ou Eolo.

L'accouplement à **Baïonnette** laisse au parasol la possibilité de pivoter et de ne pas endommager les baleines en cas de vent particulièrement fort.

Il est possible d'ajouter le Bloque-Parasol ( voir page suivante ).

L'accouplement **Eolo** fixe les pôles supérieur et inférieur avec une vis.

es / Aluminio con anodizado anticorrosión.  
Ø 40 mm  
**Los mástiles estándar no son inclinables.** Bajo solicitud pueden equiparse con una articulación basculante.

Los mástiles se pueden suministrar en la versión de **Baioneta** o **Eolo**.

**Baioneta:** permite que el parasol pueda girar y no daña las varillas en caso de viento particularmente insistente. Se puede añadir el bloqueador del parasol (véase la página siguiente).

**Eolo:** fija el mástil superior e inferior mediante un tornillo.

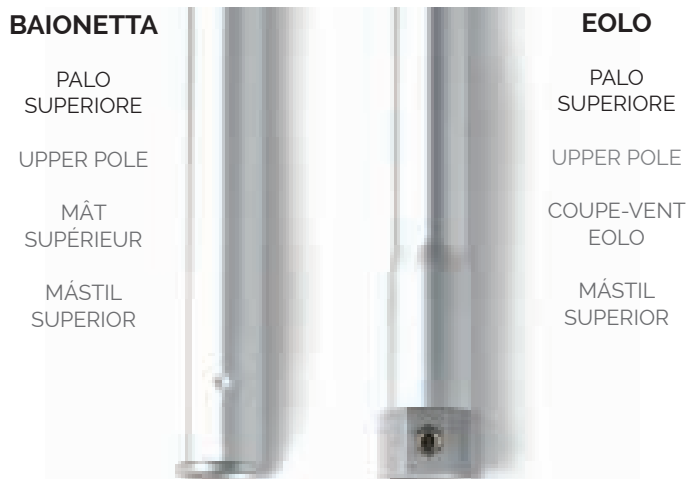

## BAIONETTA

PALO SUPERIORE

UPPER POLE

MÂT SUPÉRIEUR

MÁSTIL SUPERIOR

## EOLO

PALO SUPERIORE

UPPER POLE

COUPE-VENT EOLO

MÁSTIL SUPERIOR

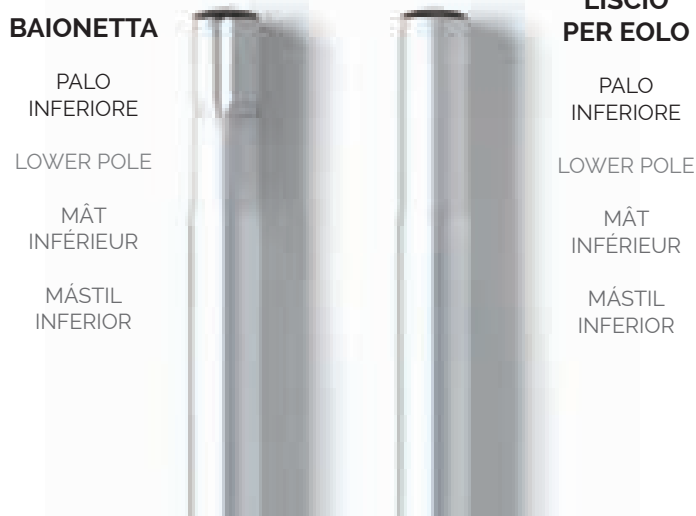

## BAIONETTA

PALO INFERIORE

LOWER POLE

MÂT INFÉRIEUR

MÁSTIL INFERIOR

## LISCIO PER EOLO

PALO INFERIORE

LOWER POLE

MÂT INFÉRIEUR

MÁSTIL INFERIOR

MISURA DEL PALO INFERIORE: DA 80 CM A 120 CM  
LOWER POLE LENGTH : FROM 80 CM TO 120 CM  
LONGUEUR DU MÂT INFÉRIEUR : DE 80 CM À 120 CM  
TAMAÑO DEL MÁSTIL INFERIOR: DE 80 CM A 120 CM



# REGGI OMBRELLONE CON TAVOLINETTO PARASOL HOLDER WITH TABLE PORTE-PARASOL AVEC TABLE SOPORTE DE SOMBRILLA CON MESA PEQUEÑA

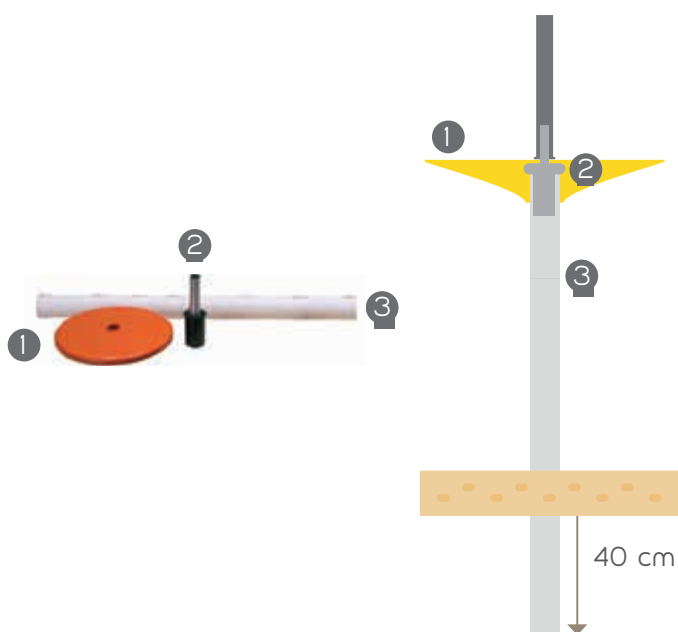

it / COMPOSTO DA TRE PARTI:

Tavolino rotondo Ø 40 cm in moplen (colori: beige, arancio, giallo, verde, blu, bianco), colonna disponibile solo nel colore bianco. Giunto per l'aggancio del palo superiore dell'ombrellone. La colonna va parzialmente inserita nella sabbia e una volta unita al giunto, sostituisce il palo inferiore dell'ombrellone.

en / COMPOSED OF THREE PARTS::

Round table Ø 40 cm in moplen (available in beige, orange, yellow, green, blue, white), column available only in white color, and Joint for the coupling of the upper pole of the parasol. The Column has to be partially inserted in the sand, and once joined to the Joint it replaces the lower pole of the parasol.

fr / COMPOSÉ DE TROIS PARTIES :

Table ronde Ø 40 cm en moplen (disponible dans les couleurs : beige, orange, jaune, vert, bleu, blanc), colonne disponible uniquement en blanc, et joint pour la fixation du mât supérieur du parasol. La colonne doit être partiellement insérée dans le sable et une fois jointe au joint, elle remplace le mât inférieur du parasol.

es / CONSTA DE TRES PARTES:

Mesa auxiliar redonda Ø 40 cm en abs (colores: beige, naranja, amarillo, verde, azul y blanco), columna solo disponible en blanco. Junta para enganchar el mástil superior de la sombrilla. La columna se introduce parcialmente en la arena y, una vez unida a la junta, sustituye el mástil inferior de la sombrilla.

# BLOCCA OMBRELLONE PARASOL LOCK BLOQUE-PARASOL BLOQUEADOR DE SOMBRILLAS

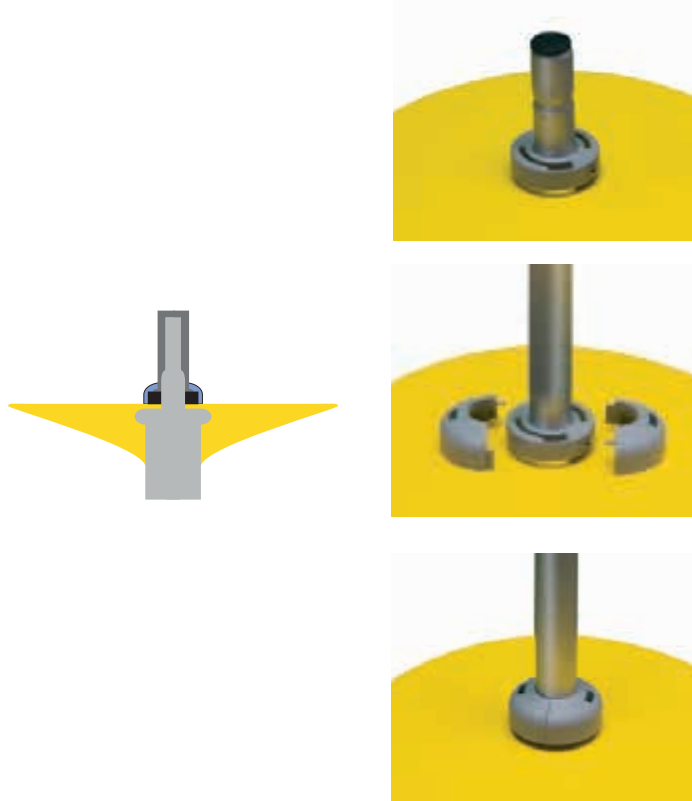

it / Disponibile per tutte le tipologie di palo dei nostri ombrelloni, fatta eccezione per i pali con innesto Eolo. E' composto da n°3 stampi in materiale plastico di alta qualità e 2 grani in acciaio inox. Lascia all'ombrellone la possibilità di ruotare. Facilissimo l'assemblaggio anche su ombrelloni usati.

en / Available for all our kind of poles for our parasols, with the exception of the Eolo coupling.

It is composed by 3 elements in plastic molds of high quality, and by 2 stainless steel screws.

It leaves the parasol the possibility to rotate.

It is very easy to assemble, even on parasols used already.

fr / Disponible pour tous les types de mâts de nos parasols, à l'exception des mâts avec accouplement Eolo.

Il est composé de 3 moules en matière plastique de haute qualité et de 2 vis en acier inoxydable. Il laisse au parasol la possibilité de pivoter. Très facile à monter même sur des parapluies usagés.

es / Disponible para todos los tipos de mástiles de nuestras sombrillas con acoplamiento antiviento Eolo. Consta de tres moldes de plástico de alta calidad y dos granos de acero inoxidable. Permite que la sombrilla gire. Fácil montaje incluso en sombrillas usadas.



# ACCESSORI PER OMBRELLONI / ACCESSORIES FOR UMBRELLAS ACCESSOIRES POUR PARASOLS / ACCESORIOS PARA SOMBRILLAS

Tavolinetto in moplen per colonna  
Table for column in moplen  
Table en moplen pour colonne  
Mesa de moplen para columna



Ø 40 cm



L 43 cm  
P 43 cm  
H 10 cm  
1 pz  
Kg 1

L 43 cm  
P 43 cm  
H 87 cm  
10 pz  
Kg 10

Tavolinetto in abs per palo  
Table for pole in abs  
Table en abs pour mât  
Mesa en abs para mástil



Ø 40 cm



L 42 cm  
P 42 cm  
H 9 cm  
1 pz  
Kg 1

L 53 cm  
P 42 cm  
H 42 cm  
10 pz  
Kg 8

Tavolinetto in legno per colonna e palo  
Table for column and pole in wood  
Table en bois pour colonne et mât  
Mesa de madera para columna y mástil



50x50 cm

L 52 cm  
P 52 cm  
H 6 cm  
1 pz  
Kg 3

L 120 cm  
P 120 cm  
H 110 cm  
50 pz  
Kg 175

Copri ombrelloni  
Materiale: rafia sintetica  
Parasol covers  
Material: synthetic raffia  
Housses pour parasols  
Matière : raphia synthétique  
Fundas para sombrillas  
Material: rafia sintética



Numeratore per colonna  
Column numbers  
Numérateur par colonne  
Numerador por columna



Numeratore per palo  
Pole numbers  
Numérateur pour mât  
Numerador por mástil



Posacenere  
Ashtrays  
Cendrier  
Ceniceros

L 60 cm  
P 40 cm  
H 60 cm  
100 pz  
Kg 16

Colonna 120 cm  
Column 120 cm  
Colonne 120 cm  
Columna 120 cm

L 12 cm  
P 12 cm  
H 125 cm  
1 pz  
Kg 3

L 120 cm  
P 110 cm  
H 165 cm  
250 pz  
Kg 520

it / BASI PORTA OMBRELLONE in polipropilene riempite con cemento, complete di tubo per l'innesto del palo dell'ombrellone.

en / PARASOL HOLDER BASES in polypropylene filled with cement with cement, complete with tube for grafting the parasol pole.

fr / BASES PORTE-PARASOLS en polypropylène remplie de béton, et incluant le manchon pour mât.

es / BASES PORTASOMBRILLAS de polipropileno rellenas de cemento, con tubo para fijar el mástil de la sombrilla.

Per Big Majestic 300x300cm bisogna considerare il tubo con Ø 50 mm.  
For Big Majestic 300x300cm, the tube with a 50 mm diameter must be considered.

Pour Big Majestic 300x300cm, il faut considérer le manchon de Ø 50mm.  
Para Big Majestic 300x300cm hay que considerar el tubo de 50 cm de diámetro.



Ø 43 cm  
27 kg

L 60 cm  
P 45 cm  
H 25 cm  
1 pz  
Kg 35



Ø 43 cm  
52 kg

L 130 cm  
P 90 cm  
H 70 cm  
24 pz  
Kg 690



Ø 54cm  
32 kg

L 60 cm  
P 60 cm  
H 25 cm  
1 pz  
Kg 40

L 120 cm  
P 110 cm  
H 70 cm  
12 pz  
Kg 415



Ø 54 cm  
48 kg

L 60 cm  
P 60 cm  
H 25 cm  
1 pz  
Kg 55

L 120 cm  
P 110 cm  
H 70 cm  
12 pz  
Kg 610

 misure/ sizes

# PIAZZA

500x400 cm  
500x500 cm  
600x500 cm  
600x600 cm

1 pz

L 450 cm  
P 40 cm  
H 40 cm  
Kg 110TELESCOPICO  
TELESCOPIC  
TELESCOPIC  
TELESCÓPICO

it / Ombrellone gigante con sistema telescopico a doppio ragno che ne consente la chiusura sopra sedie e tavoli sottostanti, senza il bisogno di spostarli. Struttura in alluminio verniciato e acciaio inox. Sfiatatoio incluso.

en / Giant parasol with double frame telescopic system that allows it to be closed over chairs and tables below without having to move them. It is manufactured with an aluminum powder coated and stainless steel structure. Wind vent included.

fr / Parasol géant avec système télescopique à double structure qui permet de le fermer au-dessus des chaises et des tables en dessous, sans avoir besoin de les déplacer. Structure en aluminium peint avec des poudres époxy et en acier inoxydable. Évent inclus.

es / Sombrilla gigante con sistema telescópico de doble araña que permite plegarla sobre las sillas y mesas inferiores sin necesidad de moverlas. Estructura de aluminio pintado y acero inoxidable. Incluye rejilla de ventilación.





# PIAZZA

TELESCOPICO  
TELESCOPIC  
TÉLESCOPIQUE  
TELESCÓPICO



Tessuto in acrilico 100%, gr. 320 m/q, trattato antimuffa, idrorepellente e resistente agli agenti atmosferici  
Fabric 100% Acrylic, gr.320 m/q, anti-mold, water-repellent, and weather resistant treatments  
Tissu 100% acrylique, gr. 320 m/q, traité anti-moisissure, hydrofuge et résistant aux intempéries  
Tejido y borde 100 % acrilicos, 320 g/m2, con tratamiento antimoho, hidrófugo y resistente a la intemperie.



Gambone pieghevole in acciaio inox, con cerniera  
Stainless steel tilting tube with hinge  
Tube basculant avec fermeture éclair, en acier inoxydable  
Pata plegable de acero inoxidable



1 pz

L 70 cm  
P 22 cm  
H 20 cm  
Kg 10



Tubo interno in acciaio inox  
Stainless steel internal pole  
Tube intérieur en acier inoxydable  
Tubo interior de acero inoxidable



Corona e collano in acciaio inox  
Stainless steel collar and crown  
Couronne et collier en acier inoxydable  
Corona y piña central de acero inoxidable



Giunto stecche  
Joint ribs  
Joint baleines  
Unión varillas



Base a vista in alluminio con piastre  
Aluminium base at sight with plates  
Base en aluminium à vue avec plaques  
Base visible con placas



1 pz

L 110 cm  
P 110 cm  
H 30 cm  
Kg 180



Contropiastra da cementare  
Counterplate to be cemented  
Contreplaque à cimenter  
Contraplaca que se debe cementar



1 pz

L 20 cm  
P 20 cm  
H 5 cm  
Kg 15

TELAIO:  
FRAME:  
STRUCTURE:  
ESTRUCTURA:

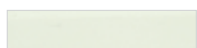

BIANCO  
WHITE  
BLANC  
BLANCO



ANTRACITE  
ANTHRACITE  
ANTRACITA  
ANTRACITA



## ACCESSORI / ACCESSORIES ACCESSOIRES / ACCESORIOS

ATTREZZATURA IN ACCIAIO INOX  
EQUIPMENT IN STAINLESS STEEL  
ÉQUIPEMENT EN ACIER INOXYDABLE  
ELEMENTOS DE ACERO INOXIDABLE



it /

- 1 - Carrello portalettini;
- 2 - Trivella per palo ombrellone;
- 3 - Trivella per colonna;
- 4 - Manico inox;
- 5 - Vallo;
- 6 - Rastrello senza rete;
- 7 - Rastrello con rete;
- 8 - Retino.

en /

- 1 - Trolley for sunbeds;
- 2 - Auge for parasol lower poles;
- 3 - Auge for parasol lower column;
- 4 - Handle for rake or sand sieve;
- 5 - Sand sieve;
- 6 - Rake without net;
- 7 - Rake with net
- 8 - Net.

fr /

- 1 - Chariot porte-transat;
- 2 - Tarière pour mât de parasol;
- 3 - Tarière pour colonne;
- 4 - Poignée en acier inoxydable;
- 5 - Tamis à sable;
- 6 - Râteau sans filet;
- 7 - Râteau avec filet;
- 8 - Filet.

es /

- 1 - Carro portabumbonas;
- 2 - Piqueta para mástil de la sombrilla;
- 3 - Piqueta para columna;
- 4 - Asa de acero inoxidable;
- 5 - Tamiz para arena;
- 6 - Rastrillo sin red;
- 7 - Rastrillo con red;
- 8 - Red.

TRIVELLA PER SABBIA O TERRENO  
AUGER FOR SAND OR GROUND  
TARIÈRE POUR SABLE OU TERRE  
PIQUETA PARA ARENA O TERRENO



it / Trivella per ancoraggio ombrellone su sabbia o terreno.

en / Auger for anchoring parasol on sand or ground.

fr / Tarière pour ancrer le parasol sur le sable ou sur la terre.

es / Piqueta para anclar una sombrilla en la arena o en el terreno.

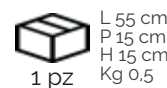

L 55 cm  
P 15 cm  
H 15 cm  
Kg 0,5



L 42 cm  
P 60 cm  
H 40 cm  
Kg 13

1 pz

40 pz



# ACCESSORI / ACCESSORIES / ACCESSOIRES / ACCESORIOS

PORTARIFIUTI  
WASTE BINS  
POUBELLES À DÉCHETS  
CUBOS DE BASURA

LT 90



FIORIERE  
PLANTERS  
JARDINIÈRE  
MACETAS

Può essere usato: come recipiente portarifiuti o fioriera.  
It can be used as planter or container for the waste bin.  
Peut être utilisé : comme poubelle à déchets ou comme jardinière.  
Puede utilizarse: como recipiente para residuos o como maceta.



H 37 cm  
L 100 cm  
P 53 cm



H 80 cm  
Ø 51 cm

COLONNA PER GEL IGIENIZZANTE  
COLUMN FOR SANITIZING GEL  
COLONNE POUR GEL ASSAINISSANT  
COLUMNA PARA GEL DESINFECTANTE

it / Colonna per gel e mascherine. Disponibile in legno impregnato a bagno per utilizzo per esterno oppure in alluminio.  
- pannello per applicazione di un cartello illustrativo formato A4,  
- mensola contenitiva per dispenser di gel igienizzante,  
- mensola per mascherine o guanti.  
Al posto della mensola porta gel può trovare facile alloggio il dispenser automatico no touch.

fr / Colonne pour gels et masques. Disponible en bois imprégné ou en aluminium pour utilisation à l'extérieur également  
- panneau pour l'application d'un panneau illustratif au format A4  
- étagère pour distributeur de gel désinfectant  
- étagère pour masques ou gants.  
A Le distributeur automatique sans contact peut être facilement installé à la place de l'étagère porte-gel.



en / Column for sanitizing gel, gloves, and masks, available in wood color-impregnated or in aluminum, both versions treated for outdoor use  
- with panel for the application of an illustrative sign in A4 format  
- shelf to hold the sanitizing gel dispenser  
- shelf for gloves or masks  
Since the column is internally empty, there is the possibility of inserting weights if it is unstable due to a non-level flooring, such as on sand.  
In alternative to the shelf to hold the gel dispenser, you can consider the no touch sanitizing gel dispenser.

es / Columna para geles y mascarillas. Disponible en madera impregnada (para uso exterior) o en aluminio.  
- panel para la aplicación de un cartel ilustrativo formato A4,  
- balda para para el dispensador de gel desinfectante,  
- balda para mascarillas o guantes.  
En lugar de la balda para el gel, se puede acomodar fácilmente el dispensador automático sin contacto.

misure/ sizes

LEGNO / WOOD	ALLUMINIO / ALUMINIUM
H 156 cm	H 176 cm
L 45 cm	L 40 cm
P 45 cm	P 40 cm
1 pz L 150 cm P 10 cm H 10 cm Kg 10,5	1 pz L 150 cm P 10 cm H 10 cm Kg 7
40 pz L 150 cm P 80 cm H 160 cm Kg 430	40 pz L 150 cm P 80 cm H 160 cm Kg 295



# DAYBED JOY

 misure/ sizes



200x200 cm  
H 226 cm

## ACCESSORI / ACCESSORIES / ACCESOIRES / ACCESORIOS:

Tende  
Curtains  
Rideaux  
Cortinas

n.2 Materassini filtranti, cad.  
200x100 cm, spessore 10 cm.  
n.2 Filtering mattresses with  
Milano fabric, each 200x10 cm,  
thickness 10 cm.  
n.2 Matelas filtrants en tissu Mila-  
no, chacun 200x10 cm, épaisseur  
10 cm.  
n.2 Colchoneta filtrantes, cada  
una 200x100cm, espesor 10cm.

n.4 Piastre in acciaio inox per  
fissaggio a terra.  
n.4 Stainless steel plates for fixing  
to the ground.  
n.4 Plaques en acier inoxydable  
pour la fixation au sol.  
n.4 Placas de acero inoxidable  
para fijación al suelo.

it / Struttura in alluminio verniciato bianco.  
Copertura in tessuto plastificato RAM ombreggiante.  
Non impermeabile. Ferramenta in acciaio inox AISI 316.

en / Aluminum structure powder coated in white color.  
Cover with RAM fabric. Shading. Not waterproof.  
Hardware in AISI 316 stainless steel.

fr / Structure en aluminium de couleur blanche avec des poudres époxy.  
Couverture en tissu RAM. Ombrage. Non imperméable.  
Quincaillerie en acier inoxydable AISI 316.

es / Estructura de aluminio pintado de blanco.  
Cubierta de tela de sombra plastificada RAM. No es impermeable.  
Herrajes en acero inoxidable AISI 316.

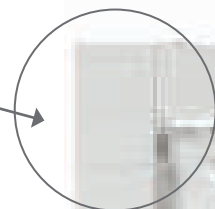
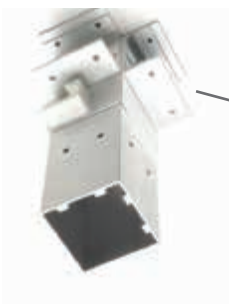

Angolari aventi profilo con spessore maggiorato e filettato per una più efficace tenuta della vite.  
Corners with profile with increased thickness and threaded for a more effective holding of the screw.  
Pièces d'angle avec profil à épaisseur augmentée et fileté pour un maintien plus efficace de la vis.  
Ángulos con mayor grosor y perfil roscado para una sujeción más eficaz de los tornillos.

**TELAIO:  
FRAME:  
STRUCTURE:  
ESTRUCTURA:**

BIANCO  
WHITE  
BLANC  
BLANCO

Su richiesta può essere realizzato con altre finiture.  
On request it can be made in other finishes.  
Sur demande, il peut être réalisé avec d'autres finitions.  
Bajo solicitud se puede realizar con otros acabados.

 misure/ sizes
200x200 cm  
H 226 cm**ACCESSORI / ACCESSORIES /  
ACCESOIRES / ACCESORIOS:**Tende  
Curtains  
Rideaux  
Cortinasn.2 Materassini filtranti tessuto Mi-  
lano, cad. 195x80 cm, spessore 5 cm  
n.2 Filtering mattresses with Milano  
fabric, each 195x80 cm, thickness  
5 cmn.2 Matelas filtrants en tissu Milano,  
chacun 195x80 cm, épaisseur 5 cm  
n.2 Esteras filtrantes de tela Milano,  
cada una 195x80cm, espesor 5cmn.2 Cuscini filtranti tra i lettini tessuto  
Milano, spessore 5 cmn.2 Filtering cushions between the  
sunbeds, with Milano fabric, thick-  
ness 5 cmn.2 Coussins filtrants entre les  
transats, en tissu Milano, épaisseur  
5 cmn.2 Cojines filtrantes entre las camas  
en tejido Milano de 5 cm de espesorn.4 Piastre in acciaio inox per fis-  
saggio a terran.4 Stainless steel plates for fixing to  
the groundn.4 Plaques en acier inoxydable pour  
la fixation au soln.4 Placas de acero inoxidable para  
fijación al suelo

inox

zincata  
galvanized

# DAYBED SUITE

it / Struttura in legno di abete lamellare. Completo di 2 lettini "RELAX" a doghe in legno di frasino, della misura 196,5x86,5 cm, con 6 inclinazioni dello schienale, regolabile con scaletta. Comprensivo di cassetti portaoggetti e appendiabiti.

Copertura mediante tessuto RAM. Ombreggiante. Non impermeabile.

Ferramenta in acciaio inox AISI 316.

Essendo legno, si raccomanda una manutenzione con prodotti specifici per tale materiale.

en / Structure made of lamellar fir wood.

Included 2 "RELAX" sunbeds with ashwood slats, measuring 196,5x86,5 cm, with 6 backrest inclinations, by ladder. Including storage drawers and coat hangers.

Cover with RAM fabric. Shading. Not waterproof. Hardware in AISI 316 stainless steel.

Being wood, the maintenance with specific products for this material is recommended.

fr / Structure en bois de sapin lamellé.

Compris 2 transats "RELAX" à lattes en frêne, mesurant 196,5x86,5 cm, avec 6 inclinaisons de dossier, avec échelle. Y compris les tiroirs de rangement et les cintres.

Couverture en tissu RAM. Ombreage. Non imperméable. quincaillerie en acier inoxydable AISI 316.

Cependant, étant bois, un entretien avec des produits spécifiques pour ce matériau est recommandé.

es / Estructura en madera de abeto laminada. Completo con 2 tumbonas "RELAX"

con listones de madera de fresno de 196,5x86,5 cm cada una con 6 posiciones de respaldo, mediante escalera. Incluye cajones de almacenamiento y perchas.

Revestimiento con tela RAM. sombreado. No impermeable. Herrajes en acero inoxidable AISI 316.

Al ser de madera, se recomienda el mantenimiento con productos específicos para dicho material.

**COLORI LEGNO:****WOOD COLORS:****COULEURS DE BOIS:****COLORES DE MADERA:**BIANCO PIENO  
FULL WHITE  
BLANC PLEIN  
BLANCO SÓLIDONOCE  
WALNUT  
NOYER  
NOGAL

Angolari in alluminio verniciato in  
tinta.

Corners in aluminum powder coated.

Pièces d'angle en aluminium peintes  
avec des poudres époxy.

Cantoneras en aluminio pintado del  
mismo color.

6 POSIZIONI  
6 POSITIONS6 



# TENDOMBRA

 misure/ sizes



APERTO/OPEN  
L 215 cm P 140 cm  
H 195 cm  
CHIUSO/CLOSED  
L 243 cm  
H 234 cm



1 pz

L 240 cm  
P 20 cm  
H 10 cm  
Kg 16,3



20 pz

L 250 cm  
P 80 cm  
H 120 cm  
Kg 350

- it / Struttura in alluminio verniciato bianco. Tessuto Milano.  
Il tessuto è personalizzabile con nome, logo o disegni del cliente.  
Ferramenta inox AISI 316.
- en / Structure in white powder coated aluminum. Milano fabric.  
The fabric can be customized with the customer's own name, logo,  
design. Hardware Inox AISI 316.
- fr / Structure en aluminium peint en blanc avec des poudres époxy.  
Tissu Milano.  
Le tissu peut être personnalisé avec le nom, le logo ou les dessins  
du client. Quincaillerie en acier inoxydable AISI 316.
- es / Estructura de aluminio pintado en blanco. Tejido Milano.  
El tejido puede personalizarse con el nombre, el logotipo o el diseño  
del cliente. Herrajes de acero inoxidable AISI 316.

TESSUTO:  
FABRIC:  
TISSU:  
TEJIDO:



MILANO bianco

TELAIO:  
FRAME:  
STRUCTURE:  
ESTRUCTURA:

BIANCO  
WHITE  
BLANC  
BLANCO

Su richiesta può essere realizzato con altre finiture.  
On request it can be made in other finishes.  
Sur demande, il peut être réalisé avec d'autres finitions.  
Bajo solicitud se puede realizar con otros acabados.



Esaedro



# GAZEBO IN ALLUMINIO

## ALUMINIUM GAZEBO

### GAZEBO EN ALUMINIUM

### GAZEBO DE ALUMINIO

 misure/ sizes



300x300 cm  
H 226 cm



1 pz

L 300 cm  
P 80 cm  
H 40 cm  
Kg 105



5 pz

L 300 cm  
P 80 cm  
H 140 cm  
Kg 450

Su richiesta può essere fornito con altre misure.

Other measures can be supplied upon request.

Sur demande, il peut être fourni avec d'autres mesures.

Se puede suministrar en tamaños bajo solicitud.

it / Struttura in alluminio. Copertura in tessuto plastificato RAM ombreggiante. Non impermeabile. Possibilità di scorrimento della copertura da un lato all'altro, e di sgancio da entrambi i lati. Piastre in acciaio inox per fissaggio a terra. Ferramenta in acciaio inox AISI 316.

en / Aluminum structure, and cover with RAM fabric. Shading. Not waterproof. Possibility of sliding the cover from one side to the other, and release from both sides. Stainless steel plates for fixing to the ground. Bolts in Inox AISI 316

fr / Structure en aluminium. Couverture en tissu RAM perforé d'ombrage non imperméable. Possibilité de faire coulisser la couverture d'un côté à l'autre, et de le déverrouiller des deux côtés. Plaques en acier inoxydable pour fixation au sol. Quincaillerie en acier inoxydable AISI 316.

es / Estructura de aluminio. Cubierta de tela de sombra plastificada RAM. No es impermeable. Posibilidad de deslizar la cobertura de un lado a otro y de soltarla por ambos lados. Placas de acero inoxidable para la fijación al suelo. Herrajes de acero inoxidable AISI 316

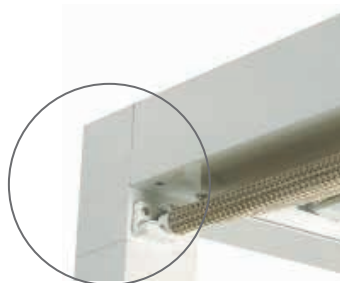
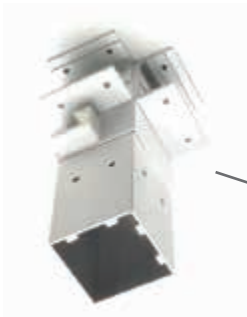

it / Angolari aventi profilo con spessore maggiorato e filettato per una più efficace tenuta della vite. Sistema di aggancio e sgancio rapido della copertura.

en / Corners with profile with increased thickness and threaded for a more effective holding of the screw. Quick coupling and release system.

fr / Pièces d'angle avec profil à épaisseur augmentée et fileté pour un maintien plus efficace de la vis. Système d'accrochage et décrochage rapide.

es / Ángulos con mayor grosor y perfil roscado para una sujeción más eficaz de los tornillos. Sistema de acoplamiento y desacoplamiento rápido.

TESSUTO:  
FABRIC:  
TISSU:  
TEJIDO:



RAM 107



RAM 102

TELAIO:  
FRAME:  
STRUCTURE:  
ESTRUCTURA:

BIANCO  
WHITE  
BLANC  
BLANCO



# GAZEBO IN LEGNO

## WOODEN GAZEBO

### GAZEBO EN BOIS

### GAZEBO DE MADERA

 misure/ sizes



250x250 cm  
300X300 cm  
H 226 cm



1 pz

L 280 cm  
P 50 cm  
H 50 cm  
Kg 90



3 pz

L 280 cm  
P 80 cm  
H 160 cm  
Kg 290

**TESSUTO:**  
**FABRIC:**  
**TISSU:**  
**TEJIDO:**

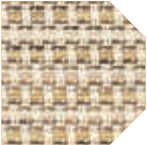

RAM 107



RAM 102

- it / Struttura in legno di abete lamellare. Copertura mediante tessuto traforato RAM. Ombreggiante. Non impermeabile. Angolari in alluminio verniciato. Piastre in acciaio inox per fissaggio a terra. Ferramenta in acciaio inox AISI 316. Essendo legno, si raccomanda una manutenzione con prodotti specifici per tale materiale.
- en / Structure made lamellar fir wood. Cover with RAM fabrics. Shading. Not waterproof. Powder coated aluminum corners. Stainless steel plates for fixing to the ground. Bolts in Inox AISI 316. Being wood, the maintenance with specific products for this material is recommended.
- fr / Structure en bois de sapin lamellé. Couverture en tissu RAM perforé d'ombrage non imperméable. Pièces d'angle en aluminium peintes. Plaques en acier inoxydable pour fixation au sol. Quincaillerie en acier inoxydable AISI 316. Cependant, étant bois, un entretien avec des produits spécifiques pour ce matériau est recommandé.
- es / Estructura de madera laminada de abeto. Cubierta de tejido RAM perforado. De sombra. No es impermeable. Esquinas de aluminio pintadas. Placas de acero inoxidable para la fijación al suelo. Herrajes de acero inoxidable AISI 316. Al ser de madera, se recomienda el mantenimiento con productos específicos para dicho material.



**COLORI LEGNO:**  
**WOOD COLORS:**  
**COULEURS DE BOIS:**  
**COLORES DE MADERA:**

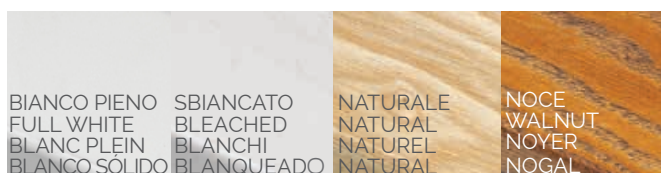



# PEDANE OUTDOOR

## OUTDOOR PLATFORMS

### PLATES-FORMES POUR EXTÉRIEUR

### PLATAFORMAS DE EXTERIOR

#### PEDANA IN POLIETILENE POLYETHYLENE PLATFORM PLATEFORME EN POLYETHYLENE PLATAFORMA DE POLIETILENO

cm 50x70  
cm 50x100

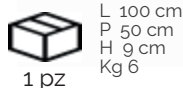
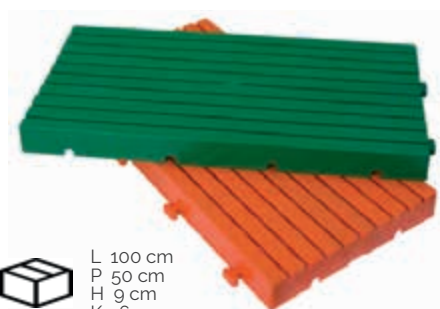

L 100 cm  
P 50 cm  
H 9 cm  
Kg 6

1 pz



L 100 cm  
P 60 cm  
H 95 cm  
Kg 65

10 pz

it / Materiale: polietilene antiscivolo e stabilizzato ai raggi UV.  
Ogni pedana è corredata di appositi ganci che ne consentono l'unione sia dal lato lungo, sia da quello corto. E', perciò, possibile ottenere pavimentazioni di qualsiasi dimensione o passerelle larghe cm. 50 - 70 - 100 e con lunghezza a piacere.

en / Material: polyethylene non-slip, and UV resistant  
Each platform is equipped with special hooks that allow them to be joined together both from the long side and from the short side. It is therefore possible to obtain floorings and walkways of any size with widths from 50-70-100 cm and length as desired.

fr / Matière : polyéthylène anti-dérapant et stabilisé aux UV  
Chaque plate-forme est équipée de crochets spéciaux qui permettent de la joindre à la fois du côté long et du côté court. Il est donc possible d'obtenir des revêtements de sol de toutes dimensions, ou des passerelles d'une largeur de 50 ou 70 ou 100 cm et de la longueur au choix

es / Material: polietileno antideslizante y estabilizado a los rayos UV.  
Cada baldosa está dotada de ganchos especiales que permiten unirla tanto por el lado largo como por el corto. Por lo tanto, es posible obtener suelos de cualquier tamaño o pasarelas de 50 - 70 - 100 cm de ancho y cualquier longitud.

#### PEDANA IN LEGNO WOODEN PLATFORM PLATEFORME EN BOIS PLATAFORMA DE MADERA

cm. 92,5 x 100 cm



L 100 cm  
P 93 cm  
H 5 cm  
Kg 18,2

1 pz



L 120 cm  
P 100 cm  
H 165 cm  
Kg 560

30 pz

it / Pedana modulare in legno montata su 3 binari in alluminio fissata con appositi rivetti. Giunti in nylon inclusi. Moduli di dimensioni differenti a richiesta. Possono essere impiegate per normali passerelle e come pavimentazione per gazebo, spazio giochi, lastricato per piscine e centri fitness.

en / Modular wooden platform, mounted on 3 aluminum rails and fixed with specific rivets. Nylon joints included. On request, platforms of different sizes can be produced. It can be used to create walkways, as well as floorings for gazebos, children's play area, swimming pools, and fitness centers.

fr / Plate-forme modulaire en bois montée sur 3 rails en aluminium fixés avec des rivets spéciaux. Joints en nylon inclus. Modules de dimensions différentes sur demande. Ils peuvent être utilisés pour les passerelles et comme revêtement de sol pour les gazebos, les aires de jeux, les piscines et les centres de fitness.

es / Plataforma modular de madera montada sobre 3 railes de aluminio fijados con remaches. Incluye juntas de nylon. Módulos de diferentes tamaños bajo solicitud. Se pueden utilizar para pasarelas normales y como pavimento para gazebos, parques infantiles, pavimentación de piscinas y gimnasios.





# PEDANE OUTDOOR

## OUTDOOR PLATFORMS

### PLATES-FORMES POUR EXTÉRIEUR

### PLATAFORMAS DE EXTERIOR

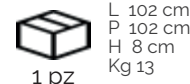

1 pz

L 102 cm  
P 102 cm  
H 8 cm  
Kg 13

20 pz

L 120 cm  
P 100 cm  
H 128 cm  
Kg 255

it / Pedana composta da profilo in alluminio che contiene 2 pedane di legno ricoperte dal nostro tessuto in pvc, ottenendo così una pavimentazione rialzata dove è possibile nascondere e far passare cavi elettrici o connessioni varie sottostanti.

Consente un frequente cambio di look a costi bassissimi, con personalizzazione per eventi (compleanni, matrimoni, comunioni ecc).

en / Platform composed by two wooden platforms covered with our pvc fabric, contained by a aluminium profile, thus obtaining a raised floor where it is possible to easily hide and pass electrical cables or various connections underneath.

It allows a frequent change of look at very low costs, as well as the possibility of customizing the fabric for events, such as birthdays, weddings, ceremonies, etc.

fr / Plate-forme composée d'un profilé en aluminium qui contient 2 plates-formes en bois recouvertes de notre tissu PVC, obtenant ainsi un plancher surélevé où il est possible de cacher et de faire passer des câbles électriques ou diverses connexions en dessous.

Il permet un changement de look fréquent à très faible coût, avec une personnalisation pour les événements (anniversaires, mariages, communions, etc.).

es / Plataforma formada por un perfil de aluminio que contiene 2 plataformas de madera cubiertas con nuestra tela de pvc, lo que da lugar a un suelo elevado en el que es posible ocultar y pasar los cables eléctricos o las distintas conexiones por debajo.

Permite un cambio de look frecuente a muy bajo coste, con personalización para eventos (cumpleaños, bodas, comuniones, etc.).

### PEDANA IN LEGNO E TESSUTO WOODEN AND FABRIC PLATFORM PLATEFORME EN BOIS ET TISSU PLATAFORMA DE MADERA Y TELA



cm. 100x100 cm h.6 cm

### PEDANA IN MARMORESINA

### MARBLE RESIN PLATFORM

### PLATE-FORME EN RÉSINE MARBRE

### PLATAFORMA DE RESINA DE MÁRMOL

it / Pedana in Marmoresina adatta per realizzare nuove pavimentazioni o sovrapporre a quelle esistenti.

Facili da montare e smontare, vengono alloggiati all'interno di un apposito telaio in alluminio, ottenendo così una pavimentazione rialzata (dove nascondere e far passare facilmente cavi elettrici o connessioni varie).

#### Caratteristiche Marmoresina:

antisdrucciolo, antimacchia, inassorbente, ingelivo e inattaccabile dalla salsedine.

en / Marmoresina platform particularly suitable for creating new floors or overlapping existing ones.

Easy to assemble and disassemble, they are contained by a aluminium profile, thus obtaining a raised floor where it is possible to easily hide and pass electrical cables or various connections underneath.

#### Features Marmoresina:

non-slip, stain-resistant, non-absorbent, frost-resistant and resistant to salt.

fr / Plate-forme Marmoresina idéale pour créer de nouveaux sols ou superposer ceux existants.

Faciles à monter et à démonter, ils sont logés à l'intérieur d'une structure en aluminium, obtenant ainsi un plancher surélevé où il est possible de cacher et de faire passer des câbles électriques ou diverses connexions en dessous.

#### Caractéristiques de Marmoresina :

antidérapant, anti-taches, non absorbant, anti-gel et inattaquable par le sel.

es / Plataformas de resina de mármol adecuadas para crear nuevos pavimentos o recubrir los existentes.

Fáciles de montar y desmontar, se alojan en el interior de un marco especial de aluminio, obteniendo así un suelo flotante (donde se pueden ocultar y pasar fácilmente los cables eléctricos o las distintas conexiones).

#### Características de la resina de mármol:

antideslizante, resistente a las manchas, no absorbente, resistente a las heladas y a la sal.



#### Dimensioni esterne del telaio in alluminio:

L 100 cm P 100 cm H 6 cm ;  
All'interno del telaio in alluminio vengono alloggiati n. 2 lastre (L94,8cm x P44,3cm cad).

Peso: pedana completa 37,5 kg (struttura alluminio: 3,7 kg ; n.2 pedane Marmoresina: 16,9 kg cadauna)

#### External dimensions of the aluminum frame:

L 100 cm W 100 cm H 6 cm ;  
Inside the aluminum frame are housed n. 2 plates (L94.8cm x P44.3cm each).

Weight: complete 37,5 kg platform (aluminum structure: 3,7 kg ; 2 Marmoresina platforms: 16,9 kg each)

#### Dimensions extérieures de la structure aluminium :

L 100 cm P 100 cm H 6 cm ;  
A l'intérieur de la structure en aluminium sont logés n. 2 dalles (L94,8cm x D44,3cm chacune).

Poids : plateforme complète 37,5 kg ( structure aluminium : 3,7 kg ; 2 plate-formes Marmoresina : 16,9 kg chacune )

#### Medidas externas de la estructura de aluminio:

A 100 cm F 100 cm Al 6 cm ;  
Las 2 placas (94,8 cm de ancho x 44,3 cm de fondo cada una) se alojan dentro de la estructura de aluminio.

Peso: plataforma completa 37,5 kg (estructura de aluminio: 3,7 kg ; 1 plataforma de resina de mármol: 16,9 kg)





# CABINE IN LEGNO GREZZO

## RAW WOODEN CABINS

### CABINES EN BOIS BRUT

### CABINAS DE MADERA SIN TRATAR

 misure/ sizes

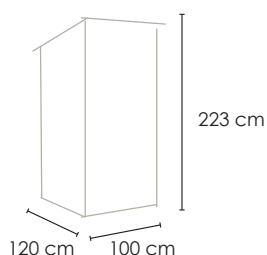
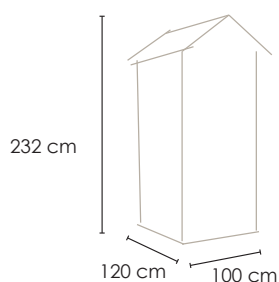

it / Struttura autoportante con telaio in legno immaschiato ed incollato. L'assemblaggio è reso semplice dalla soluzione di cerniere in acciaio inox che vengono unite con apposito inserto. Le cabine sono fornite complete di pavimento, panca, mensola e attaccapanni. Essendo le cabine in legno grezzo, se utilizzate esternamente, il legno deve essere necessariamente impregnato e protetto, ed il tetto deve essere incatramato.

en / Self-supporting structure with tapped and glued wooden frame. Easy to assemble, thanks to the stainless steel hinges that are joined with a special insert. The cabins are furnished complete with floor, seat bench, shelf, and hanger. Being the cabins in raw wood, if used externally the wood must necessarily be impregnated and protected, and the roof must be tarred.

fr / Structure autoportante en bois taraudé et collé. L'assemblage est rendu simple par la solution de charnières en acier inoxydable qui sont reliées par un insert spécial. Les cabines sont livrées complètes avec plancher, banc, étagère et cintre. Les cabines étant en bois brut, si utilisées à l'extérieur, le bois doit obligatoirement être imprégné et protégé, et le toit doit être goudronné.

es / Estructura autoportante con marco de madera moldeada y pegada. El montaje es fácil gracias a las bisagras de acero inoxidable que se unen con una inserción especial. Dado que las cabinas son de madera sin tratar, si se utilizan en el exterior, la madera debe estar necesariamente impregnada y protegida, y el techo debe estar alquitranado. Las cabinas se suministran completas con suelo, banco, balda y perchero.

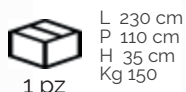

L 230 cm  
P 110 cm  
H 35 cm  
Kg 150

1 pz



L 230 cm  
P 110 cm  
H 150 cm  
Kg 615

4 pz



L 220 cm  
P 110 cm  
H 35 cm  
Kg 140

1 pz



L 220 cm  
P 110 cm  
H 150 cm  
Kg 570

4 pz

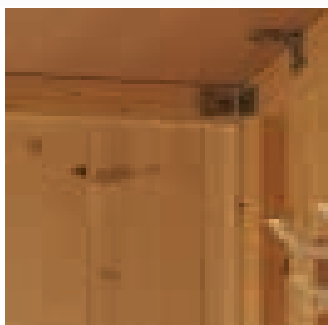



Sedute e Tavoli  
Seats and Tables  
Sièges et Tables  
Asientos y mesas





## misura/ sizes

L 57 cm  
P 55 cm  
H 82 cm  
Hs 46/47 cmimpilabile  
stackable  
empilable  
apilable

1 pz

L 65 cm  
P 60 cm  
H 85 cm  
Kg 8

10 pz

L 120 cm  
P 80 cm  
H 150 cm  
Kg 100

# SAMANTHA

- it / Sedia con braccioli. Struttura in alluminio verniciato. Seduta e schienale in tessuti Milano o COR. Pensata per arredare ambienti indoor e outdoor, è realizzata con materiali resistenti e facili da pulire. Ferramenta inox AISI 316.
- en / Chair with armrests. Structure in powder coated. Seat and back in Milano or Cor fabrics. Designed for indoor and outdoor environments, it is made with resistant and easy to clean materials. Hardware Inox AISI 316.
- fr / Chaise avec accoudoirs. Structure en aluminium peinte avec des poudres époxy. Assise et dossier en tissus Milano ou COR. Conçue pour meubler des environnements intérieurs et extérieurs, il est fabriqué avec des matériaux résistants et faciles à nettoyer. Quincaillerie en acier inoxydable AISI 316.
- es / Silla con reposabrazos. Estructura de aluminio pintado. Asiento y respaldo en tejidos Milano o COR. Diseñada para amueblar ambientes interiores y exteriores, está fabricada con materiales duraderos y fáciles de limpiar. Herrajes de acero inoxidable AISI 316.

VERNICIATO  
POWDER COATED  
PEINT AVEC DES POUDRE ÉPOXY  
PINTADOBIANCO  
WHITE  
BLANC  
BLANCOANTRACITE  
ANTHRACITE  
ANTHRACITE  
ANTRACITAGRIGIO METALLIZZATO  
METAL GREY  
GRIS MÉTALLISÉ  
GRIS METALIZADONERO  
BLACK  
NOIR  
NEGRO



misure/ sizes

L 55 cm  
P 52 cm  
H 88 cm  
Hs 48 cmpieghevole  
folding  
pliable  
plegable

2 pz

L 94 cm  
P 33 cm  
H 54 cm  
Kg 13

28 pz

L 130 cm  
P 100 cm  
H 210 cm  
Kg 210

cm 88

CHIUSO/CLOSED  
FERMÉ/CERRADO

# REGISTA LEGNO

## WOODEN DIRECTOR'S CHAIR

### METTEUR EN SCÈNE EN BOIS

### SILLA DE DIRECTOR DE MADERA

it / Sedia Regista con struttura in legno di frassino di primissima qualità. Adatto per l'esterno perché trattato con impregnazione del legno a più mani con speciali vernici in vasche di colore e con incollaggio delle parti in legno tramite speciale colla marina. Ferramenta inox AISI 316. Essendo legno, si raccomanda una manutenzione con prodotti specifici per tale materiale.

en / Wooden Director's Chair, with structure in first quality ash wood, particularly suitable for outdoor use because it is treated with impregnation of the wood in several hands with special paints in color vats, and with gluing of the wooden parts using special marine glue, Hardware Inox AISI 316. Being wood, the maintenance with specific products for this material is recommended.

fr / Metteur en Scène en bois de frêne de haute qualité. Idéale pour l'extérieur car il est traité avec une imprégnation du bois en plusieurs couches avec des peintures spéciales dans des baignoires avec couleur. Collage des parties en bois est réalisée à l'aide d'une colle marine spéciale. Quincaillerie en acier inoxydable AISI 316. Cependant, étant du bois, un entretien avec des produits spécifiques pour ce matériau est recommandé.

es / Silla de director con estructura de madera de fresno de primera calidad. Adecuada para exteriores porque ha sido tratada impregnando la madera en varias capas con pinturas especiales en tanques de color y pegando las partes de madera con cola marina especial. Herrajes de acero inoxidable AISI 316. Al ser de madera, se recomienda el mantenimiento con productos específicos para dicho material.

**COLORI LEGNO:**  
**WOOD COLORS:**  
**COULEURS DE BOIS:**  
**COLORES DE MADERA:**BIANCO PIENO  
FULL WHITE  
BLANC PLEIN  
BLANCO SÓLIDOSBIANCATO  
BLEACHED  
BLANCHI  
BLANQUEADONATURALE  
NATURAL  
NATUREL  
NATURALNOCE  
WALNUT  
NOYER  
NOGALMOGANO  
MAHOGANY  
ACAJOU  
CAOBANERO  
BLACK  
NOIR  
NEGROWENGÉ  
WENGE  
WENGÉ  
WENGE

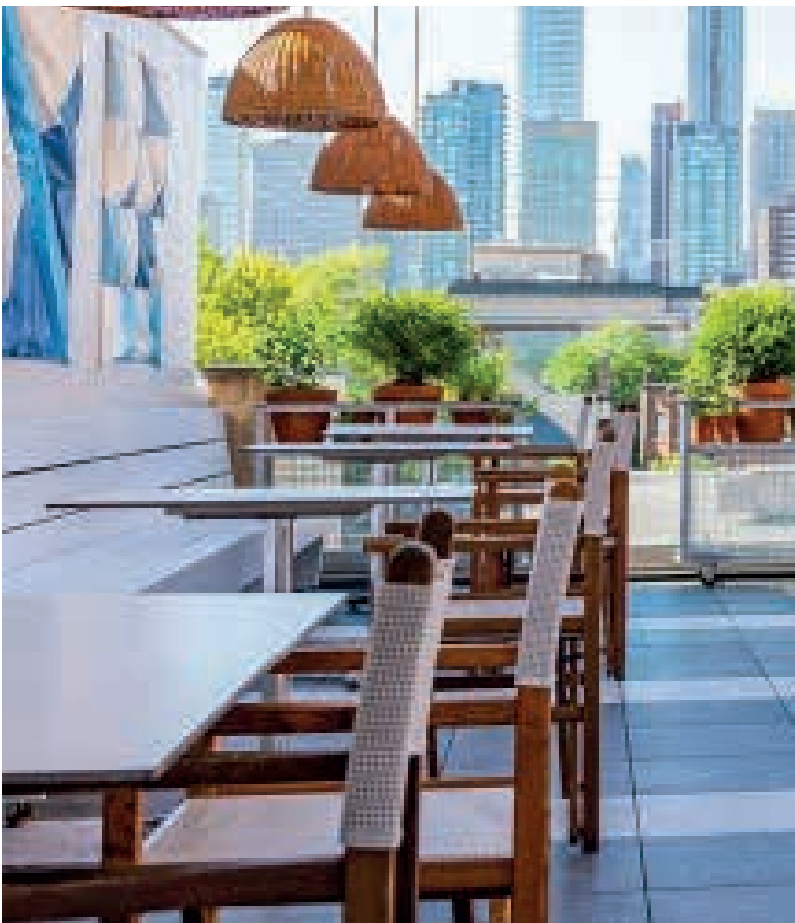

 misure/ sizes

L 55 cm  
P 52 cm  
H 121 cm  
Hs 78 cm



pieghevole  
folding  
pliable  
plegable



1 pz

L 110 cm  
P 51 cm  
H 24 cm  
Kg 5,4



30 pz

L 120 cm  
P 120 cm  
H 200 cm  
Kg 180



cm 121

CHIUSO/CLOSED  
FERMÉ/CERRADO

# SGABELLO REGISTA IN LEGNO

## WOODEN DIRECTOR'S STOOL

### TABOURET METTEUR EN SCÈNE EN BOIS

### TABURETE DE DIRECTOR DE MADERA

it / Sgabello Regista con struttura in legno di frassino di primissima qualità. Adatto per l'esterno perché trattato con impregnazione del legno a più mani con speciali vernici in vasche di colore e con incollaggio delle parti in legno tramite speciale colla marina. Ferramenta inox AISI 316. Essendo legno, si raccomanda una manutenzione con prodotti specifici per tale materiale.

en / Wooden Director's stool, with structure in first quality ash wood, particularly suitable for outdoor use because it is treated with impregnation of the wood in several hands with special paints in color vats, and with gluing of the wooden parts using special marine glue, Hardware Inox AISI 316. Being wood, the maintenance with specific products for this material is recommended.

fr / Metteur en Scène en bois de frêne de première qualité. Idéale pour l'extérieur car il est traité avec une imprégnation du bois en plusieurs couches avec des peintures spéciales dans des baignoires avec couleur, et avec collage des parties en bois à l'aide d'une colle marine spéciale. Quincaillerie en acier inoxydable AISI 316. Cependant, étant bois, un entretien avec des produits spécifiques pour ce matériau est recommandé.

es / Taburete con estructura de madera de fresno de primera calidad. Adecuada para exteriores porque ha sido tratada impregnando la madera en varias capas con pinturas especiales en tanques de color y pegando las partes de madera con cola marina especial. Herrajes de acero inoxidable AISI 316. Al ser de madera, se recomienda el mantenimiento con productos específicos para dicho material.



**COLORI LEGNO:**  
**WOOD COLORS:**  
**COULEURS DE BOIS:**  
**COLORES DE MADERA:**

BIANCO PIENO  
FULL WHITE  
BLANC PLEIN  
BLANCO SÓLIDO

SBIANCATO  
BLEACHED  
BLANCHI  
BLANQUEADO

NATURALE  
NATURAL  
NATUREL  
NATURAL

NOCE  
WALNUT  
NOYER  
NOGAL

MOGANO  
MAHOGANY  
ACAJOU  
CAOBA

NERO  
BLACK  
NOIR  
NEGRO

WENGÉ  
WENGÉ  
WENGÉ  
WENGÉ



## misure/ sizes

L 56 cm  
P 46 cm  
H 90,5 cm  
Hs 48 cmpieghevole  
folding  
pliable  
plegable

2 pz

L 55 cm  
P 32 cm  
H 95 cm  
Kg 11

24 pz

L 125 cm  
P 100 cm  
H 185 cm  
Kg 155

cm 90.5

CHIUSO/CLOSED  
FERMÉ/CERRADO

## misure/ measures

L 56 cm  
P 46 cm  
H 90,5 cm  
Hs 48 cmpieghevole  
folding  
pliable  
plegable

2 pz

L 55 cm  
P 32 cm  
H 95 cm  
Kg 11

24 pz

L 125 cm  
P 100 cm  
H 185 cm  
Kg 155

cm 90.5

CHIUSO/CLOSED  
FERMÉ/CERRADOREGISTA IN ALLUMINIO  
ALUMINIUM DIRECTOR'S CHAIR  
METTEUR EN SCÈNE EN ALUMINIUM  
SILLA DE DIRECTOR DE ALUMINIO

it / Sedie con braccioli.  
Struttura in alluminio verniciato o anodizzato. Seduta e schienale vengono fornite in tessuto plastificato PVC per un'ottima resistenza agli agenti atmosferici e per un facile lavaggio senza smontarlo dall'intelaiatura. Ferramenta inox AISI 316.

en / Chairs with armrests. Structure in anodized or powder coated aluminum. Seat and backrest are supplied with PVC plasticized material for excellent resistance to atmospheric agents, and for easy washing without removing it from the frame. Hardware Inox AISI 316.

fr / Chaises avec accoudoirs. Structure en aluminium peint avec des poudres époxy ou anodisé. L'assise et le dossier sont fournis en tissu PVC plastifié pour une excellente résistance aux agents atmosphériques et pour un lavage facile sans le retirer de la structure. Quincaillerie en acier inoxydable AISI 316.

es / Sillas con reposabrazos. Estructura de aluminio pintado o anodizado. El asiento y el respaldo se suministran en tejido plastificado de PVC para una excelente resistencia a la intemperie y un fácil lavado sin necesidad de desmontarlos de la estructura. Herrajes de acero inoxidable AISI 316.

## AURORA

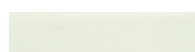
ANODIZZATO  
ANODIZED  
ANODISÉ  
ANODIZADOArgento  
Silver  
Argent  
PlataVERNICIATO  
POWDER COATED  
PEINT AVEC DES POUDRE ÉPOXY  
PINTADOBianco  
White  
Blanc  
BlancoAntracite  
Athracite  
Athracite  
AntracitaNero  
Black  
Noir  
Negro







 misure/ sizes



L 55 cm  
P 52 cm  
H 109 cm  
Hs 67 cm



pieghevole  
folding  
pliable  
plegable



1 pz

L 110 cm  
P 51 cm  
H 24 cm  
Kg 5,4



30 pz

L 120 cm  
P 120 cm  
H 200 cm  
Kg 180

# SGABELLO REGISTA

## DIRECTOR'S STOOL

### TABOURET METTEUR EN SCÈNE EN ALUMINIUM

### TABURETE DE DIRECTOR

it / Sgabello con braccioli. Struttura in alluminio verniciato o anodizzato. Seduta e schienale vengono fornite in tessuto plastificato PVC per un'ottima resistenza agli agenti atmosferici e per un facile lavaggio senza smontarlo dall'intelaiatura. Ferramenta inox AISI 316.

en / Stool with armrests. Structure in anodized or powder coated aluminum. Seat and backrest are supplied with PVC plasticized material for excellent resistance to atmospheric agents, and for easy washing without removing it from the frame. Hardware Inox AISI 316.

fr / Tabouret avec accoudoirs. Structure en aluminium peint avec des poudres époxy ou anodisé. L'assise et le dossier sont fournis en tissu PVC plastifié pour une excellente résistance aux agents atmosphériques et pour un lavage facile sans le retirer de la structure. quincaillerie en acier inoxydable AISI 316.

es / Taburete con reposabrazos. Estructura de aluminio pintado o anodizado. El asiento y el respaldo se suministran en tejido plastificado de PVC para una excelente resistencia a la intemperie y un fácil lavado sin necesidad de desmontarlos de la estructura. Herrajes de acero inoxidable AISI 316.



cm 109

CHIUSO/CLOSED  
FERMÉ/CERRADO



L 55 cm  
P 52 cm  
H 121 cm  
Hs 78 cm



pieghevole  
folding  
pliable  
plegable



1 pz

L 110 cm  
P 51 cm  
H 24 cm  
Kg 5,4



30 pz

L 120 cm  
P 120 cm  
H 200 cm  
Kg 180



ANODIZZATO  
ANODIZED  
ANODISÉ  
ANODIZADO

VERNICIATO  
POWDER COATED  
PEINT  
PINTADO



Argento  
Silver  
Argent  
Plateado

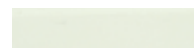

Bianco  
White  
Blanc  
Blanco



Antracite  
Athracite  
Athracite



Nero  
Black  
Noir  
Negro



cm 121

CHIUSO/CLOSED  
FERMÉ/CERRADO



POGGIAPIEDI PER  
LA VERSIONE ALTA  
FOOTREST FOR  
THE HIGH VERSION  
REPOSE PIEDS POUR LA  
VERSION HAUTE  
REPOSAPIÉS PARA  
LA VERSIÓN ALTA



## TELAI TAVOLO

TABLE FRAMES  
STRUCTURE DES TABLES  
ESTRUCTURAS MESA

 misure/ sizes



L/P 70-80-90  
H 75 cm



impilabile  
stackable  
empilable  
apilable



1 pz

L 90 cm  
P 90 cm  
H 90 cm  
Kg 18



12 pz

L 130 cm  
P 130 cm  
H 180 cm  
Kg 230

Per piano tavolo /For table tops/  
Pour plateaux de table/ Para el  
tablero de la mesa:

70x70 cm  
80 x 80 cm  
90 x90 cm

Tipologie e finiture piani pagina 77-78  
Table top types and finishes page 77-78  
Types et finitions de plateaux page 77-78  
Tipos y acabados superficies p. 77-79

# TAVERNA

it / Telaio tavolo in alluminio verniciato. Ferramenta inox AISI 316.

en / Table frame in powder coated aluminum. Hardware Inox AISI 316.

fr / Structure de table en aluminium peint avec des poudres époxy. Quincaillerie en acier inoxydable AISI 316.

es / Estructura de mesa en aluminio pintado, tablero de madera o laminado. Herrajes de acero inoxidable AISI 316.



NO ANODIZZATO  
NO ANODIZED ALUMINIUM  
PAS D'ALUMINIUM ANODISÉ  
SIN ANODIZAR



VERNICIATO  
POWDER COATED  
PEINT AVEC DES POUDRE ÉPOXY  
PINTADO



BIANCO  
WHITE  
BLANC  
BLANCO



ANTRACITE  
ANTHRACITE  
ANTRACITE  
ANTRACITA



GRIGIO METALLIZZATO  
METAL GREY  
GRIS MÉTALLISÉ  
GRIS METALIZADO



NERO  
BLACK  
NOIR  
NEGRO



**TELAIO TAVOLO****TABLE FRAMES  
STRUCTURE DES TABLES  
ESTRUCTURAS MESA** misure/ sizesL/P max 80  
H 73 cmsmontato/dismounted  
démonté/desmontado

1 pz

L 87 cm  
P 65 cm  
H 150 cm  
Kg 6,8

20 pz

L 120 cm  
P 80 cm  
H 140 cm  
Kg 150Per piano tavolo /For table tops/  
Pour plateaux de table/ Para el tablero  
de la mesa:

max Ø 80 - 80x80 cm

Tipologie e finiture piani pagina 77-78  
Table top types and finishes page 77-78  
Types et finitions de plateaux page 77-78  
Tipos y acabados superficies p.77-78FORNITI SMONTATI  
SUPPLIED DISASSEMBLED  
FOURNI DÉMONTÉ  
SE SUMINISTRA DESMONTADO**ELEGANT** LEGNO/WOOD/BOIS/MADERA

it / Telaio tavolo con struttura in legno di frassino di primissima qualità. Adatto per l'esterno perchè trattato con impregnazione del legno a più mani con speciali vernici in vasche di colore e con incollaggio delle parti in legno tramite speciale colla marina. Ferramenta inox AISI 316.

Essendo legno, si raccomanda una manutenzione con prodotti specifici per tale materiale.

en / Table frame, with structure in first quality ash wood, particularly suitable for outdoor use because it is treated with impregnation of the wood in several hands with special paints in color vats, and with gluing of the wooden parts using special marine glue, Hardware Inox AISI 316. Being wood, the maintenance with specific products for this material is recommended.

fr / Structure de table en bois de frêne de haute qualité. Idéale pour l'extérieur car il est traité avec une imprégnation du bois en plusieurs couches avec des peintures spéciales dans des baignoires avec couleur. Collage des parties en bois est réalisée à l'aide d'une colle marine spéciale. Quincaillerie en acier inoxydable AISI 316. Cependant, étant du bois, un entretien avec des produits spécifiques pour ce matériau est recommandé.

es / Estructura de mesa en aluminio pintado, tablero de madera o laminado. Adecuada para exteriores porque ha sido tratada impregnando la madera en varias capas con pinturas especiales en tanques de color y pegando las partes de madera con cola marina especial. Herrajes de acero inoxidable AISI 316.

Al ser de madera, se recomienda el mantenimiento con productos específicos para dicho material.

**COLORI LEGNO:  
WOOD COLORS:  
COULEURS DE BOIS:  
COLORES DE MADERA:**BIANCO PIENO  
FULL WHITE  
BLANC PLEIN  
BLANCO SÓLIDOSBIANCATO  
BLEACHED  
BLANCHI  
BLANQUEADONATURALE  
NATURAL  
NATUREL  
NATURALNOCE  
WALNUT  
NOYER  
NOGALMOGANO  
MAHOAGANY  
ACAJOU  
CAOBANERO  
BLACK  
NOIR  
NEGROWENGÉ  
WENGÉ  
WENGÉ  
WENGÉ

## TELAIO TAVOLO

TABLE FRAMES  
STRUCTURE DES TABLES  
ESTRUCTURAS MESA

# ELEGANT ALLUMINIO/ALUMINIUM/ALUMINIUM/ALUMINIO

misure/ sizes



L/P max 80  
H 73 cm

smontato/dismounted  
démonté/desmontado



1 pz

L 60 cm  
P 65 cm  
H 10 cm  
Kg 3,2



20 pz

L 120 cm  
P 80 cm  
H 110 cm  
Kg 90

Per piano tavolo /For table tops/  
Pour plateaux de table/ Para el  
tablero de la mesa:

max Ø 80 - 80x80 cm

Tipologie e finiture piani pagina 77-78  
Table top types and finishes page 77-78  
Types et finitions de plateaux page 77-78  
Tipos y acabados superficies p.77-78



FORNITI SMONTATI  
SUPPLIED DISASSEMBLED  
FOURNI DÉMONTÉ  
SE SUMINISTRA DESMONTADO

it / Telaio tavolo in alluminio anodizzato o verniciato. Ferramenta inox AISI 316.

en / Table frames in anodized or powder coated aluminum Hardware Inox AISI 316.

fr / Structure de table en aluminium anodisé ou peint avec des poudres époxy. Quincaillerie en acier inoxydable AISI 316.

es / Estructura de la mesa en aluminio anodizado o pintado. Herrajes de acero inoxidable AISI 316.



ANODIZZATO  
ANODIZED  
ANODISÉ  
ANODIZADO

VERNICIATO  
POWDER COATED  
PEINT AVEC DES POUDRE ÉPOXY  
PINTADO



Argento  
Silver  
Argent  
Plateado



Bianco  
White  
Blanc  
Blanco



Antracite  
Athracite  
Athracite  
Antracita



Nero  
Black  
Noir  
Negro

**TELAIO TAVOLO**TABLE FRAMES  
STRUCTURE DES TABLES  
ESTRUCTURAS MESA**ELEGANT H** misure/ sizesL/P max 70  
H 106 cmsmontato/dismounted  
démonté/desmontado

1 pz

L 60 cm  
P 95 cm  
H 10 cm  
Kg 3,5

20 pz

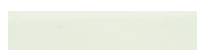
L 120 cm  
P 80 cm  
H 110 cm  
Kg 96Per piano tavolo /For table tops/  
Pour plateaux de table/ Para el  
tablero de la mesa:  
max Ø 70 / 70x70 cmTipologie e finiture piani pagina 77-78  
Table top types and finishes page 77-78  
Types et finitions de plateaux page 77-78  
Tipos y acabados superficies p.77-78ANODIZZATO  
ANODIZED  
ANODISÉ  
ANODIZADOArgento  
Silver  
Argent  
PlateadoVERNICIATO  
POWDER COATED  
PEINT AVEC DES POUDRE ÉPOXY  
PINTADOBianco  
White  
Blanc  
BlancoAntracite  
Athracite  
Athracite  
AntracitaNero  
Black  
Noir  
NegroFORNITI SMONTATI  
SUPPLIED DISASSEMBLED  
FOURNI DÉMONTÉ  
SE SUMINISTRA DESMONTADO

## PIANI TAVOLO Stratificato HPL

TABLE TOPS  
PLATEAUX DE TABLE  
TABLEROS DE MESA

HPL Laminated  
HPL Stratifié  
HPL Estratificado

Ø59 - Ø69 - Ø79 - Ø89  
59x59 - 69x69 - 79x79 - 89x89 cm

it / Piani stratificati HPL. Bordo sottile o retto.  
Cuore nero per i laminati a tinta unita. Cuore marrone per i laminati effetto legno.

en / HPL laminated tops. Thin or straight edge.  
Black core for plain color laminates. Brown core for wood-effect laminates.

fr / Plateaux stratifiés HPL. Bord fin ou droit.  
Cœur noir pour les stratifiés de couleur unie. Cœur marron pour stratifiés effet bois.

es / Tableros laminados HPL. Borde fino o recto.  
Corazón negro para laminados de color liso. Corazón marrón para laminados efecto madera.



2 pz

L 90 cm  
P 90 cm  
H 4,5 cm  
Kg 12



70 pz

L 120 cm  
P 90 cm  
H 1,50 cm  
Kg 430

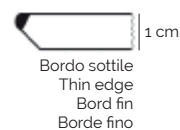

Bordo sottile  
Thin edge  
Bord fin  
Borde fino



Bordo retto  
Straight edge  
Bord droit  
Borde recto

### ARPA

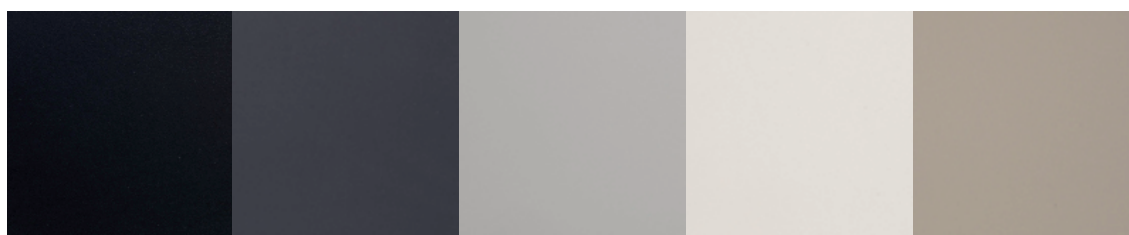

0001

0509

0526

0527

0244

0247



4511 ALEVÈ

4512 ALEVÈ

4517 ALEVÈ

4519 ALEVÈ

4529 ALEVÈ

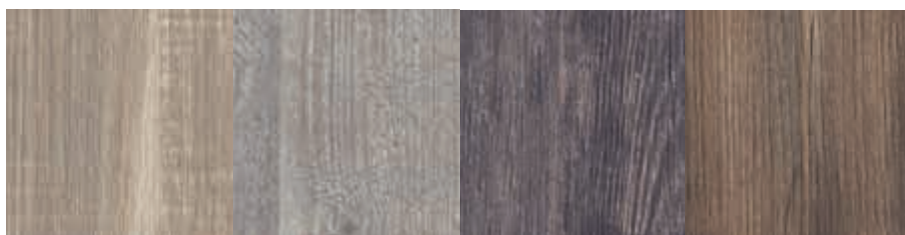

4543 ALEVÈ

4573 ALEVÈ

4575 LARIX

4587 ALEVÈ

Le immagini delle finiture sono indicative e possono subire variazioni cromatiche.  
The images of the finishes are indicative and may have chromatic variations.  
Les images des finitions sont à titre indicatif et peuvent subir des variations chromatiques.  
Las imágenes de los acabados son indicativas y pueden estar sujetas a variaciones de color.

## PIANI TAVOLO Legno

TABLE TOPS  
PLATEAUX DE TABLE  
TABLEROS DE MESA

Wood  
Bois  
Madera



L 90 cm  
P 90 cm  
H 4,5 cm  
Kg 12

1 pz



L 120 cm  
P 90 cm  
H 150 cm  
Kg 430

35 pz

## 60x60 - 70x70 - 80x080 - 90x90 cm

it / Piano a doghe h 3 cm, in legno di frassino di prima qualità. Adatto per l'esterno perchè trattato con impregnazione del legno a più mani con speciali vernici in vasche di colore e con incollaggio delle parti in legno tramite speciale colla marina. Essendo legno, si raccomanda una manutenzione con prodotti specifici per tale materiale.

en / Wooden slats table top h 3 cm in first quality ash wood, suitable for outdoor use because it is treated with impregnation of the wood in several hands with special paints in color vats, and with gluing of the wooden parts using special marine glue. Being wood, the maintenance with specific products for this material is recommended.

fr / Plateaux de table en bois avec lattes h 3 cm. Plateau à lattes h 3 cm, en bois de frêne de haute qualité. Idéal pour l'extérieur car il est traité avec une imprégnation du bois en plusieurs couches avec des peintures spéciales dans des baignoires avec couleur. Le collage des parties en bois est réalisée à l'aide d'une colle marine spéciale. Cependant, étant du bois, un entretien avec des produits spécifiques pour ce matériau est recommandé.

es / Tablero de listones 3 cm de altura, fabricado en madera de fresno de primera calidad. Adecuada para exteriores porque ha sido tratada impregnando la madera en varias capas con pinturas especiales en tanques de color y pegando las partes de madera con cola marina especial. Al ser de madera, se recomienda el mantenimiento con productos específicos para dicho material.

**COLORI LEGNO:**  
**WOOD COLORS:**  
**COULEURS DE BOIS:**  
**COLORES DE MADERA:**



BIANCO PIENO  
FULL WHITE  
BLANC PLEIN  
BLANCO SÓLIDO

SBIANCATO  
BLEACHED  
BLANCHI  
BLANQUEADO

NATURALE  
NATURAL  
NATUREL  
NATURAL

NOCE  
WALNUT  
NOYER  
NOGAL

MOGANO  
MAHOGANY  
ACAJOU  
CAOBA

NERO  
BLACK  
NOIR  
NEGRO

WENGÈ  
WENGÈ  
WENGÈ  
WENGÈ

## PIANI TAVOLO Alluminio

TABLE TOPS  
PLATEAUX DE TABLE  
TABLEROS DE MESA

Aluminium  
Aluminium  
Aluminio

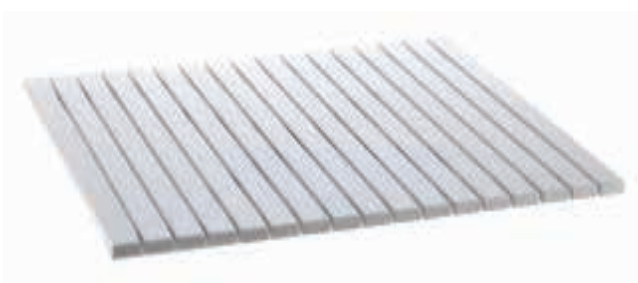

L 90 cm  
P 90 cm  
H 4,5 cm  
Kg 6

1 pz



L 120 cm  
P 90 cm  
H 150 cm  
Kg 215

35 pz

ANODIZZATO  
ANODIZED  
ANODISÉ  
ANODIZADO



Argento  
Silver  
Argent  
Plateado

## 70x70 - 80x080 - 90x90 cm

Piano a doghe in alluminio.

Aluminum slats table top.

Plateau à lattes en aluminium.

Tablero de listones de aluminio.

VERNICIATO  
POWDER COATED  
PEINT AVEC DES POUDRE ÉPOXY  
PINTADO

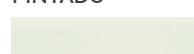

Bianco  
White  
Blanc  
Blanco



Antracite  
Athracite  
Athracite  
Antracita



Nero  
Black  
Noir  
Negro

Le immagini delle finiture sono indicative e possono subire variazioni cromatiche.  
The images of the finishes are indicative and may have chromatic variations.  
Les images des finitions sont à titre indicatif et peuvent subir des variations chromatiques.  
Las imágenes de los acabados son indicativas y pueden estar sujetas a variaciones de color.

## misure/ sizes

 LxP 80x80 cm  
H 72 cm

 pieghevole  
folding  
pliable  
plegable

 L 104 cm  
P 80 cm  
H 6 cm  
Kg 9,7

1 pz

20 pz

 L 120 cm  
P 80 cm  
H 135 cm  
Kg 210

 LxP 60x60 cm  
H 46 cm

 pieghevole  
folding  
pliable  
plegable

 L 72 cm  
P 60 cm  
H 6 cm  
Kg 6

1 pz



40 pz

 L 120 cm  
P 80 cm  
H 135 cm  
Kg 255

 LxP 70x42 cm  
H 46 cm

 pieghevole  
folding  
pliable  
plegable

 L 55 cm  
P 7 cm  
H 6 cm  
Kg 5

1 pz



40 pz

 L 120 cm  
P 80 cm  
H 135 cm  
Kg 215

## misure/ sizes

 LxP 60x40 cm  
H 37 cm

 L 40 cm  
P 60 cm  
H 37 cm  
Kg 4,2

1 pz



24 pz

 L 120 cm  
P 80 cm  
H 150 cm  
Kg 117

 LxP 40x40 cm  
H 37 cm

 L 40 cm  
P 40 cm  
H 37 cm  
Kg 3,5

1 pz



36 pz

 L 120  
P 80  
H 150  
Kg 138

## TAVOLI PIEGHEVOLI ALLUMINIO FOLDING ALUMINUM TABLES TABLES PLIANTES EN ALUMINIUM MESAS PLEGABLES DE ALUMINIO

it / Tavoli pieghevoli in alluminio con piano a doghe. Ferramenta inox AISI 316.

en / Folding aluminium tables with slatted top. Hardware Inox AISI 316.

fr / Tables pliantes en aluminium avec plateau à lattes. Quincaillerie en acier inoxydable AISI 316.

es / Mesas plegables de aluminio con tablero de listones. Herrajes de acero inoxidable AISI 316.



## TAVOLINI BASSI IN ALLUMINIO ALUMINIUM LOW TABLES TABLES BASSES EN ALUMINIUM MESAS BAJAS DE ALUMINIO

it / Tavoli in alluminio con piano a doghe. Ferramenta inox AISI 316.

en / Aluminium low tables with slatted top. Hardware Inox AISI 316.

fr / Tables en aluminium avec plateau à lattes. Quincaillerie en acier inoxydable AISI 316.

es / Mesas de aluminio con tablero de listones. Herrajes de acero inoxidable AISI 316.

**ANODIZZATO**  
ANODIZED  
ANODISÉ  
ANODIZADO

 Argento  
Silver  
Argent  
Plateado

**VERNICIATO**  
POWDER COATED  
PEINT AVEC DES POUDRE ÉPOXY  
PINTADO

 Bianco  
White  
Blanc  
Blanco

 Antracite  
Athracite  
Athracite  
Antracita

 Nero  
Black  
Noir  
Negro



# TAVOLINO BASSO IN LEGNO

## LOW WOODEN TABLE

### TABLES BASSE EN BOIS

### MESA BAJA DE MADERA

misure/ sizes

 LxP 50x50 cm  
H 41 cm

1 pz

 L 50 cm  
P 50 cm  
H 41 cm  
Kg 6,8



24 pz

 L 130 cm  
P 80 cm  
H 165 cm  
Kg 180

- it / Tavolino basso in legno con piano a doghe e struttura in legno di frassino di prima qualità. Adatto per l'esterno perchè trattato con impregnazione del legno a più mani con speciali vernici in vasche di colore e con incollaggio delle parti in legno tramite speciale colla marina. Ferramenta inox AISI 316. Essendo legno, si raccomanda una manutenzione con prodotti specifici per tale materiale.
- en / Low wooden table with slatted top, with structure in first quality ash wood, particularly suitable for outdoor use because it is treated with impregnation of the wood in several hands with special paints in color vats, and with gluing of the wooden parts using special marine glue, Hardware Inox AISI 316. Being wood, the maintenance with specific products for this material is recommended.
- fr / Table basse en bois de frêne de haute qualité. Idéal pour l'extérieur car il est traité avec une imprégnation du bois en plusieurs couches avec des peintures spéciales dans des baignoires avec couleur. Le collage des parties en bois est réalisée à l'aide d'une colle marine spéciale. Quincaillerie en acier inoxydable AISI 316. Cependant, étant du bois, un entretien avec des produits spécifiques pour ce matériau est recommandé
- es / Mesa baja de madera con tablero de listones y estructura de madera de fresno de alta calidad. Adecuada para exteriores porque ha sido tratada impregnando la madera en varias capas con pinturas especiales en tanques de color y pegando las partes de madera con cola marina especial. Herrajes de acero inoxidable AISI 316. Al ser de madera, se recomienda el mantenimiento con productos específicos para dicho materia.

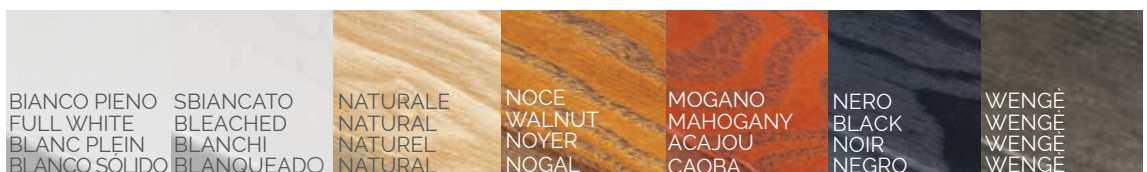

**COLORI LEGNO:**  
**WOOD COLORS:**  
**COULEURS DE BOIS:**  
**COLORES DE MADERA:**





# HAPPY

it / Prodotti in alluminio e stratificato HPL oppure nella versione in legno di frassino ed okumè di prima qualità. Adatto per l'esterno perchè trattato con impregnazione del legno a più mani con speciali vernici in vasche di colore e con incollaggio delle parti in legno tramite speciale colla marina. Ferramenta inox AISI 316.

Per la versione in legno, si raccomanda una manutenzione con prodotti specifici per tale materiale.

en / Manufactured in aluminum and HPL laminate or in first quality ash wood and okumè version, particularly suitable for outdoor use because they are treated with impregnation of the wood in several hands with special paints in color vats, and with gluing of the wooden parts using special marine glue. Hardware Inox AISI 316. For the wood version, the maintenance with specific products for this material is recommended.

fr / Fabriqués en aluminium et HPL stratifié ou dans la version en bois frêne et bois d'okoumé de haute qualité. Idéal pour l'extérieur car il est traité avec une imprégnation du bois en plusieurs couches avec des peintures spéciales dans des baignoires avec couleur. Le collage des parties en bois est réalisée à l'aide d'une colle marine spéciale. Quincaillerie en acier inoxydable AISI 316. Cependant, étant du bois, un entretien avec des produits spécifiques pour ce matériau est recommandé.

es / Producida en aluminio y laminado HPL o en madera de fresno y ocume de primera calidad. Adecuada para exteriores porque ha sido tratada impregnando la madera en varias capas con pinturas especiales en tanques de color y pegando las partes de madera con cola marina especial. Herrajes de acero inoxidable AISI 316. Al ser de madera, se recomienda el mantenimiento con productos específicos para dicho material.



ALLUMINIO VERNICIATO:  
POWDER COATED ALUMINIUM:  
ALUMINIUM PEINT AVEC DES POUDRE ÉPOXY  
ALUMINIO PINTADO:

Bianco  
White  
Blanc  
Blanco

Antracite  
Athracite  
Athracite  
Antracita

Nero  
Black  
Noir  
Negro

PAGINA / PAGE 77  
STRATIFICATO HPL  
HPL LAMINATED  
FINITIONS HPL STRATIFIÉ  
ACABADOS LAMINADOS HPL



misure / sizes

sgabello / stool  
tabouret / taburete:

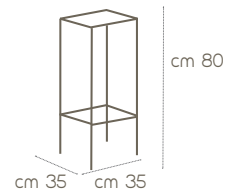

L 35 cm  
P 35 cm  
H 82 cm  
Kg 6



L 120 cm  
P 85 cm  
H 160 cm  
Kg 90

tavolo / table  
table/mesa:

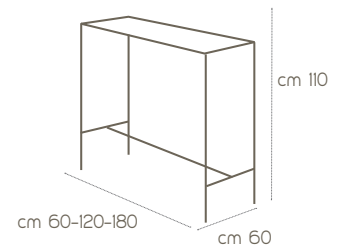

60x60x110 cm



L 60 cm  
P 60 cm  
H 110 cm  
Kg 10



L 120 cm  
P 110 cm  
H 190 cm  
Kg 75

120x60x110 cm



L 120 cm  
P 60 cm  
H 110 cm  
Kg 20



L 120 cm  
P 120 cm  
H 125 cm  
Kg 55

180x60x110 cm



L 180 cm  
P 60 cm  
H 110 cm  
Kg 30



L 180 cm  
P 120 cm  
H 125 cm  
Kg 75

**COLORI LEGNO:**  
**WOOD COLORS:**  
**COULEURS DE BOIS:**  
**COLORES DE MADERA:**

NATURALE  
NATURAL  
NATUREL  
NATURAL

NOCE  
WALNUT  
NOYER  
NOGAL

MOGANO  
MAHOGANY  
ACAJOU  
CAOBA

NERO  
BLACK  
NOIR  
NEGRO

WENGÉ  
WENGÉ  
WENGÉ  
WENGÉ

 misure / sizes

## LIBECCIO

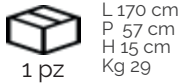
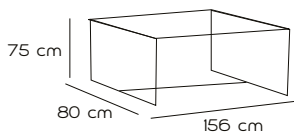

L 170 cm  
P 57 cm  
H 15 cm  
Kg 29



L 180 cm  
P 80 cm  
H 170 cm  
Kg 305

## MAESTRALE

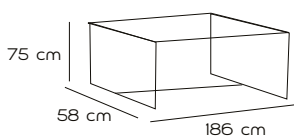

L 140 cm  
P 80 cm  
H 115 cm  
Kg 35



L 150 cm  
P 80 cm  
H 160 cm  
Kg 370

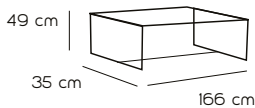

L 140 cm  
P 35 cm  
H 15 cm  
Kg 16,5



L 150 cm  
P 80 cm  
H 160 cm  
Kg 345

FORNITI SMONTATI  
SUPPLIED DISASSEMBLED  
FOURNI DÉMONTÉ  
SE SUMINISTRA DESMONTADO

**COLORI LEGNO:**  
**WOOD COLORS:**  
**COULEURS DE BOIS:**  
**COLORES DE MADERA:**

NATURALE  
NATURAL  
NATUREL  
NATURAL

NOCE  
WALNUT  
NOYER  
NOGAL

MOGANO  
MAHOAGANY  
ACAJOU  
CAOBA

NERO  
BLACK  
NOIR  
NEGRO

WENGE  
WENGE  
WENGE  
WENGE

## LIBECCIO - MAESTRALE

- it / Telaio in alluminio verniciato e piano a doghe in legno di frassino di prima qualità. Adatto per l'esterno perchè trattato con impregnazione del legno a più mani con speciali vernici in vasche di colore e con incollaggio delle parti in legno tramite speciale colla marina. Ferramenta inox AISI 316. Essendo legno, si raccomanda una manutenzione con prodotti specifici per tale materiale.
- en / Table with structure in powder coated aluminum frame and top quality ash wood slatted top, particularly suitable for outdoor use because it is treated with impregnation of the wood in several hands with special paints in color vats, and with gluing of the wooden parts using special marine glue. Hardware Inox AISI 316. Being wood, the maintenance with specific products for this material is recommended.
- fr / Structure en aluminium peint avec des poudre époxy et plateau en lattes en bois frêne et bois d'okoumè de haute qualité. Idéal pour l'extérieur car il est traité avec une imprégnation du bois en plusieurs couches avec des peintures spéciales dans des baignoires avec couleur. Le collage des parties en bois est réalisée à l'aide d'une colle marine spéciale. Quincaillerie en acier inoxydable AISI 316. Cependant, étant du bois, un entretien avec des produits spécifiques pour ce matériau est recommandé.
- es / Estructura de aluminio pintado y tablero de listones de madera de fresno de alta calidad. Adecuada para exteriores porque ha sido tratada impregnando la madera en varias capas con pinturas especiales en tanques de color y pegando las partes de madera con cola marina especial. Herrajes de acero inoxidable AISI 316. Al ser de madera, se recomienda el mantenimiento con productos específicos para dicho material.

ALLUMINIO VERNICIATO:  
PAINTED ALUMINIUM:  
ALUMINIUM PEINT AVEC DES POUDRE ÉPOXY:  
ALUMINIO PINTADO:

Bianco  
White  
Blanc  
Blanco

## LIBECCIO TAVOLO/TABLE

MAESTRALE TAVOLO E PANCA / TABLE AND BENCH  
TABLE ET BANC / MESA Y BANCO

**OPZIONI / OPTIONS**
**OPTIONNEL / OPCIONES:**

- Legno bicolore
- Cuscino filtrante h 5cm
- Two-Tone Wood
- Filtering Cushions h5cm
- Bois bicolore
- Coussin filtrant h 5cm
- Madera bicolor
- Cojín filtrante de 5cm de altura

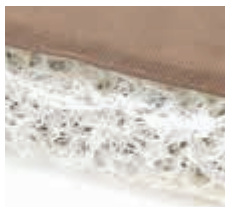
**PAGINA / PAGE 31**

Cuscino filtrante  
Filtering cushion  
Coussin filtrant  
Cojín filtrante

# SORRENTO

it / Struttura realizzata interamente in legno di frassino di prima qualità. Adatto per l'esterno perchè trattato con impregnazione del legno a più mani con speciali vernici in vasche di colore e con incollaggio delle parti in legno tramite speciale colla marina. Ferramenta inox AISI 316. Possibilità di scelta della finitura bicolore: fianchi 1 colore; seduta e schienale 1 altro colore. Essendo legno, si raccomanda una manutenzione con prodotti specifici per tale materiale.

en / Structure made entirely of first quality ash wood, particularly suitable for outdoor use because it is treated with impregnation of the wood in several hands with special paints in color vats, and with gluing of the wooden parts using special marine glue. Hardware Inox AISI 316 Possibility of choosing the two-tone finish: sides in 1 color; seat and back 1 other color. Being wood, the maintenance with specific products for this material is recommended.

fr / Structure entièrement en bois de frêne de haute qualité. Idéal pour l'extérieur car il est traité avec une imprégnation du bois en plusieurs couches avec des peintures spéciales dans des baignoires avec couleur. Le collage des parties en bois est réalisée à l'aide d'une colle marine spéciale. Quincaillerie en acier inoxydable AISI 316. Cependant, étant du bois, un entretien avec des produits spécifiques pour ce matériau est recommandé. Possibilité de choisir la finition bicolore : côtés en 1 couleur ; assise et dossier 1 autre couleur.

es / Estructura realizada íntegramente en madera de fresno de alta calidad. Adecuada para exteriores porque ha sido tratada impregnando la madera en varias capas con pinturas especiales en tanques de color y pegando las partes de madera con cola marina especial. Herrajes de acero inoxidable AISI 316.

Al ser de madera, se recomienda el mantenimiento con productos específicos para dicho material. Opción de acabado bicolore: laterales de un color; asiento y respaldo de otro color.

**COLORI LEGNO:  
WOOD COLORS:  
COULEURS DE BOIS:  
COLORES DE MADERA:**

BIANCO PIENO  
FULL WHITE  
BLANC PLEIN  
BLANCO SÓLIDO

SBIANCATO  
BLEACHED  
BLANCHI  
BLANQUEADO

NATURALE  
NATURAL  
NATUREL  
NATURAL

NOCE  
WALNUT  
NOYER  
NOGAL

MOGANO  
MAHOGANY  
ACAJOU  
CAOBA

NERO  
BLACK  
NOIR  
NEGRO

WENGÉ  
WENGÉ  
WENGÉ  
WENGÉ

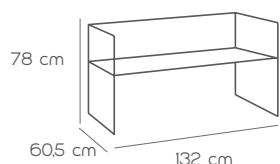
**misure/ sizes**

L 132 cm  
P 60,5 cm  
H 77 cm  
Kg 26,1



L 140 cm  
P 120 cm  
H 170 cm  
Kg 120

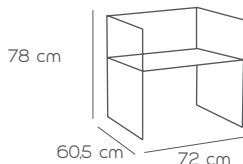

L 72,5 cm  
P 60 cm  
H 77 cm  
Kg 20,2



L 140 cm  
P 120 cm  
H 170 cm  
Kg 175

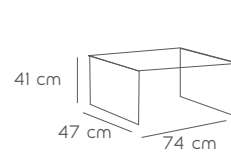

L 42,5 cm  
P 47 cm  
H 75 cm  
Kg 11



L 140 cm  
P 80 cm  
H 185 cm  
Kg 150

ANODIZZATO  
ANODIZED  
ANODISÉ  
ANODIZADO

Argento  
Silver  
Argent  
Plateado

VERNICIATO  
POWDER COATED  
PEINT AVEC DES POUDRE ÉPOXY  
PINTADO

Bianco  
White  
Blanc  
Blanco

Antracite  
Athracite  
Athracite  
Antracita

# ESAEDRO ALLUMINIO/ALUMINIUM/ALUMINIUM/ALUMINIO

- it / Telaio in alluminio verniciato o anodizzato. Seduta e schienale in PVC COR o RAM. Tavolino basso con struttura e piano a doghe, in alluminio verniciato o anodizzato.
- en / Armchair and Sofa with structure in powder coated or anodized aluminium frame, seat and back with COR or RAM fabrics. Low Table with structure and slatted top in powder coated or anodized aluminium frame.
- fr / Structure en aluminium anodisé ou peint avec des poudres époxy. Assise et dossier en COR ou RAM. Table basse avec structure et plateau à lattes en aluminium anodisé ou peint avec des poudres époxy.
- es / El cuidado de la elaboración y de los materiales refinados son el punto de partida del diseño de la colección, donde los elementos de contraste y las infinitas posibilidades de personalización aportan carácter y encanto.



Si consiglia di sostituire le fascette tendi telo ogni anno.  
It is recommended to replace the straps that stretch the fabric once per year.  
Il est recommandé de remplacer les bandes de tension du tissu chaque année.  
Se recomienda sustituir las tiras de tensado de la tela cada año.

misure/ sizes

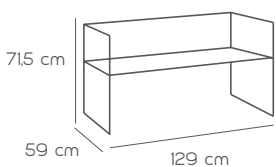

L 71.5 cm  
P 59 cm  
H 135 cm  
Kg 20,9



L 140 cm  
P 120 cm  
H 203 cm  
Kg 120

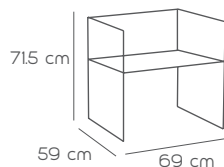

L 71.5 cm  
P 59 cm  
H 50 cm  
Kg 6,7



L 140 cm  
P 120 cm  
H 160 cm  
Kg 70

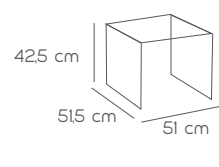

L 42 cm  
P 50 cm  
H 50 cm  
Kg 6



L 120 cm  
P 100 cm  
H 180 cm  
Kg 110

ANODIZZATO  
ANODIZED  
ANODISÉ  
ANODIZADO

Argento  
Silver  
Argent  
Plateado

VERNICIATO  
POWDER COATED  
PEINT  
PINTADO

Bianco  
White  
Blanc  
Blanco

Antracite  
Athracite  
Athracite  
Antracita

# ESAEDRO

LEGNO/WOOD/BOIS/MADERA

it / Struttura in alluminio verniciato o anodizzato, seduta e piano tavolo in legno di frassino di prima qualità. Adatto per l'esterno perchè trattato con impregnazione del legno a più mani con speciali vernici in vasche di colore e con incollaggio delle parti in legno tramite speciale colla marina. Ferramenta inox AISI 316.

Essendo legno, si raccomanda una manutenzione con prodotti specifici per tale materiale.

en / Painted or anodized aluminum frame, seat and top table in wood for outdoor. Armchair, Sofa, and Low Table, with structure in powder coated or anodized aluminum and top quality ash wood slatted top and seat, particularly suitable for outdoor use because it is treated with impregnation of the wood in several hands with special paints in color vats, and with gluing of the wooden parts using special marine glue.

Hardware Inox AISI 316. Being wood, the maintenance with specific products for this material is recommended.

fr / Structure en aluminium anodisé ou peint avec des poudres époxy. Assise et dossier à lattes en bois de frêne de haute qualité. Idéal pour l'extérieur car il est traité avec une imprégnation du bois en plusieurs couches avec des peintures spéciales dans des baignoires avec couleur. Le collage des parties en bois est réalisée à l'aide d'une colle marine spéciale. Quincaillerie en acier inoxydable AISI 316.

Cependant, étant du bois, un entretien avec des produits spécifiques pour ce matériau est recommandé.

es / Marco de aluminio pintado o anodizado, asiento y tablero de madera de fresno de alta calidad. Adecuada para exteriores porque ha sido tratada impregnando la madera en varias capas con pinturas especiales en tanques de color y pegando las partes de madera con cola marina especial. Herrajes de acero inoxidable AISI 316.



COLORI LEGNO:  
WOOD COLORS:  
COULEURS DE BOIS:  
COLORES DE MADERA:



BIANCO PIENO  
FULL WHITE  
BLANC PLEIN  
BLANCO SÓLIDO

SBIANCATO  
BLEACHED  
BLANCHI  
BLANQUEADO

NATURALE  
NATURAL  
NATUREL  
NATURAL

NOCE  
WALNUT  
NOYER  
NOGAL

MOGANO  
MAHOGANY  
ACAJOU  
CAOBA

NERO  
BLACK  
NOIR  
NEGRO

WENGÈ  
WENGÉ  
WENGÉ  
WENGÉ

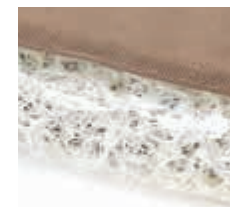

PAGINA / PAGE 31  
Cuscino filtrante  
Filtering cushion  
Cousin filtrant  
Cojin filtrante

misure / sizes

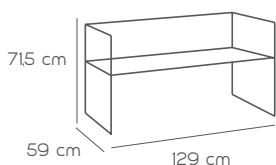

1 pz

L 71,5 cm  
P 59 cm  
H 135 cm  
Kg 22



5 pz

L 140 cm  
P 80 cm  
H 185 cm  
Kg 100

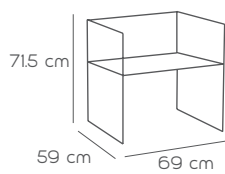

1 pz

L 71,5 cm  
P 59 cm  
H 70 cm  
Kg 11,6



8 pz

L 140 cm  
P 120 cm  
H 160 cm  
Kg 108

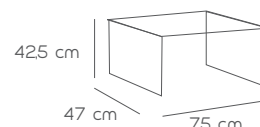

1 pz

L 42,5 cm  
P 47 cm  
H 75 cm  
Kg 7,5



12 pz

L 140 cm  
P 80 cm  
H 185 cm  
Kg 100



**COLORI LEGNO:  
WOOD COLORS:  
COULEURS DE BOIS:  
COLORES DE MADERA:**

BIANCO PIENO  
FULL WHITE  
BLANC PLEIN  
BLANCO SÓLIDO

SBIANCATO  
BLEACHED  
BLANCHI  
BLANQUEADO

NATURALE  
NATURAL  
NATUREL  
NATURAL

NOCE  
WALNUT  
NOYER  
NOGAL

MOGANO  
MAHOGANY  
ACAJOU  
CAOBA

NERO  
BLACK  
NOIR  
NEGRO

WENGÈ  
WENGÈ  
WENGÈ  
WENGÈ

**ALLUMINIO VERNICIATO:  
POWDER COATED ALUMINIUM:  
ALUMINIUM PEINT AVEC DES  
POUDRE ÉPOXY  
ALUMINIO PINTADO:**

BIANCO  
WHITE  
BLANC  
BLANCO

ANTRACITE  
ANTHRACITE  
ANTHRACITE  
ANTRACITA

FORNITI SMONTATI  
SUPPLIED DISASSEMBLED  
FOURNI DÉMONTÉ  
SE SUMINISTRA DESMONTADO

# SCRIGNO

it / Il modulo Scrigno, avente ingombro totale 200x100 h116 cm, è composto da due pedane autoportanti e rialzate della misura di 100x100 h6 cm cadauna (sotto le quali passano facilmente cavi elettrici o connessioni varie), un tavolo di cm 80x100 h73 cm e due panche contrapposte 90x40 h47 cm.

Tale soluzione garantisce la distanza di cm 100 da un cliente all'altro. Le pareti divisorie sono composte da telaio in alluminio e tessuto Milano. Su richiesta il tessuto può essere serigrafato e/o arricchito con immagini personalizzate.

I moduli possono essere collegati su tutti i lati per ottimizzare lo spazio nel miglior modo possibile.

en / The Scrigno module, having sizes 200x100 h116 cm, consists of two self-supporting and raised tiles measuring 100x100 cm each (under which electrical cables or various connections easily pass), a table of 80x100 h73 cm and two opposing benches.

This solution guarantees a distance of 100 cm from one customer to another. The partition walls are composed of an aluminum frame and Milano fabric. On request, the fabric can be screen printed and/or enriched with customized images. The modules can be connected on all sides to optimize space in the best possible way.

fr / Le module Scrigno, avec dimensions totale de 200x100 h116 cm, est composé de deux plates-formes autoportantes et surélevées, de 100 x 100 h6 cm chacune ( sous lesquelles passent facilement des câbles électriques ou diverses connexions ), une table de 80x100xh73 cm , et deux bancs opposés chacune de 90x40xh47 cm.

Cette solution garantit une distance de 100 cm entre un client et un autre. Les cloisons de séparation sont composées d'une structure en aluminium avec notre tissu Milano. Sur demande, le tissu peut être sérigraphié et/ou enrichi avec des images personnalisées. Les modules peuvent être connectés de tous les côtés pour optimiser l'espace de la meilleure façon possible.

es / El módulo Scrigno, que ocupa un espacio total de 200x100 cm y una altura de 116 cm, consta de dos plataformas elevadas y autoportantes de 100x100 cm con una altura de 6 cm cada una (bajo las cuales pueden pasar fácilmente los cables eléctricos o las distintas conexiones), una mesa de 80x100 cm con una altura de 73 cm y dos bancos opuestos de 90x40 cm con una altura de 47 cm.

Esta solución garantiza una distancia de 100 cm de un cliente a otro. Las paredes divisorias están formadas por un marco de aluminio y tejido Milano. A petición del cliente, el tejido se puede serigrafar y/o enriquecer con imágenes personalizadas.

Los módulos pueden conectarse por todos los lados para optimizar el espacio de la mejor manera posible.





# SCRIGNO

it / PANNELLI COMPONENTI E PERSONALIZZABILI  
CON ALTEZZA SU MISURA REALIZZABILE SU RICHIESTA.

en / COMPONENT AND CUSTOMIZABLE PANELS,  
WITH CUSTOMIZED HEIGHT AVAILABLE ON REQUEST.

fr / PANNEAUX COMPONENTS ET PERSONNALISABLES, ET AVEC HAUTEUR SUR MESURE  
DISPONIBLES SUR DEMANDE.

es / PANELES MODULARES Y PERSONALIZABLES  
CON ALTURA PERSONALIZADA DISPONIBLE BAJO SOLICITUD.







## TOVAGLIETTE PLACEMATES NAPPERONS MANTELES INDIVIDUALES

- it / Tovagliette in tessuto antibatterico personalizzabile.
- en / Placemats in antibacterial and customizable fabric.
- fr / Napperons en tissu antibactérien et personnalisable.
- es / Manteles individuales en tejido antibacteriano personalizable

 misure/ sizes

40x30 cm

DISPONIBILI  
ANCHE IN ALTRE  
FANTASIE O  
TINTA UNITA

ALSO AVAILABLE WITH  
OTHER PATTERNS OR IN  
PLAIN COLORS

ÉGALEMENT  
DISPONIBLE DANS  
D'AUTRES MOTIFS OU  
COULEURS UNIES

TAMBIÉN DISPONIBLE EN  
OTRAS FANTASÍAS O  
COLOR LISO



## SOTTOBICCHIERI COASTERS SOUS-VERRES POSAVASOS

- it / Sottobicchieri in tessuto antibatterico e personalizzabile.
- en / Coasters in antibacterial and customizable fabric.
- fr / Sous-verres en tissu antibactérien et personnalisable.
- es / Posavasos en tela antibacteriana y personalizable.

 misure/ sizes

Ø 12 cm

DISPONIBILI  
ANCHE IN ALTRE  
FANTASIE O  
TINTA UNITA

ALSO AVAILABLE WITH  
OTHER PATTERNS OR IN  
PLAIN COLORS

ÉGALEMENT  
DISPONIBLE DANS  
D'AUTRES MOTIFS OU  
COULEURS UNIES

TAMBIÉN DISPONIBLE EN  
OTRAS FANTASÍAS O  
COLOR LISO





25 pz

L  
P  
H  
m<sup>3</sup>

it / Struttura polifunzionale per palestre, spogliatoi e ingressi. Spazio per eventuale specchiera. Struttura in alluminio verniciato o anodizzato, seduta in legno per esterni.

en / Multifunctional structure for gyms, changing rooms, and entrances. Space for optional mirror. Structure in powder coated or anodized aluminum, wooden seat for outdoors.

fr / Structure multifonctionnelle pour gymnases, vestiaires et entrées. Espace pour un éventuel miroir. Structure en aluminium anodisé ou peint avec des poudres époxy, assise en bois pour l'extérieur.

es / Estructura multifuncional para gimnasios, vestuarios y entradas. Espacio para un posible espejo. Estructura de aluminio pintado o anodizado, asiento de madera para exteriores.

Disponibili anche su misura,  
su richiesta.

Also available custom-made  
on request

Également disponible sur mesure, sur  
demande.

También disponible en tamaños perso-  
nalizados  
bajo solicitud.



ALLUMINIO VERNICIATO  
POWDER COATED ALUMINIUM  
ALUMINIUM PEINT AVEC DES POUDRE ÉPOXY  
ALUMINIO PINTADO



BIANCO  
WHITE  
BLANC  
BLANCO



ANTRACITE  
ANTHRACITE  
ANTHRACITE  
ANTRACITA

**COLORI LEGNO**  
**WOOD COLORS**  
**COULEURS DE BOIS**  
**COLORES DE MADERA**



BIANCO PIENO  
FULL WHITE  
BLANC PLEIN  
BLANCO SÓLIDO

SBIANCATO  
BLEACHED  
BLANCHI  
BLANQUEADO

NATURALE  
NATURAL  
NATUREL  
NATURAL

NOCE  
WALNUT  
NOYER  
NOGAL

MOGANO  
MAHOGANY  
ACAJOU  
CAOBA

NERO  
BLACK  
NOIR  
NEGRO

WENGÉ  
WENGÉ  
WENGÉ  
WENGÉ

# TESSUTI / FABRICS TISSUS / TEJIDOS



it /

## PVC CON CARATTERISTICHE IGIENIZZANTI E SANIFICANTI

### --> Sistema igienizzante e sanificante

Il nostro tessuto pvc, prodotto da **Ramfil Srl**, azienda del gruppo Ramberti, ha caratteristiche igienizzanti e sanificanti grazie all'inserimento di un trattamento antimicrobico che consente una azione fungistatica e batteriostatica evitando il rischio di infezioni, efficace contro un largo spettro di germi, lieviti e muffe. Nello specifico questo additivo agisce sulla parete della cellula del microorganismo, privandola della capacità di nutrirsi e quindi di crescere e proliferare.

### --> Sicurezza di igiene e pulito che dura nel tempo

Il trattamento è integrato nel processo di fabbricazione del filo e diventa parte intrinseca del materiale aumentandone la resistenza all'attacco dei microrganismi. Non viene rilasciato all'esterno.

### Vantaggi del nostro tessuto PVC:

- » Protezione dal danneggiamento bloccando l'adesione di funghi, alghe e muffe;
- » Ottima solidità all'azione dilavante dell'acqua;
- » Buona resistenza alla putrefazione;
- » Impedisce la formazione di macchie colorate di origine microbica ( pink stain )
- » Compatibilità con l'ambiente.

Il nostro tessuto pvc è **realizzato con materie prime pienamente conformi ai Regolamenti nazionali ed internazionali vigenti**. In particolare il prodotto soddisfa quanto previsto dal Regolamento REACH n. 1907/2006.

en /

## PVC WITH HYGIENIZING AND SANITIZING CHARACTERISTICS

### --> Hygienizing and sanitizing system

Our pvc fabrics, produced by **Ramfil Srl**, one of the Ramberti Group companies, have hygienizing and sanitizing characteristics thanks to the inclusion of an antimicrobial treatment, which allows a fungistatic and bacteriostatic action avoiding the risk of infections, as well as effective against a wide spectrum of germs, yeasts, and molds. Specifically, this additive acts on the cell wall of the microorganism, depriving it of the ability to feed itself and therefore to grow and proliferate.

### --> Safety of hygiene and clean which lasts over time

The treatment is integrated into the manufacturing process of the wire, and becomes an intrinsic part of the material, increasing its resistance to attack by microorganisms, and is not released to the outside.

### --> Advantages of our PVC fabrics:

- » Protection from damage by blocking the adhesion of fungi, algae, and molds
- » Excellent solidity to the washing action of water
- » Good rot resistance
- » Prevents the formation of colored spots of microbial origin (pink stain)
- » Compatibility with the environment

Our pvc fabrics are made **with raw materials that fully comply with the National and International Regulations in force**. In particular, the product meets the requirements of the REACH Regulation n. 1907/2006.

## PVC AVEC CARACTÉRISTIQUES ASSAINISSANTES ET DÉSINFECTANTS

### --> Système d'assainissement et de désinfection

Notre tissu pvc, produit par **Ramfil Srl**, une société du groupe Ramberti, possède des caractéristiques assainissantes et désinfectantes grâce à l'inclusion d'un traitement antimicrobien qui permet une action fongistatique et bactériostatique évitant le risque d'infections, efficace contre un large spectre de germes, levures et moisissures.

En particulier, cet additif agit sur la paroi cellulaire du micro-organisme, le privant de la capacité de se nourrir et donc de se développer et proliférer.

### --> Sécurité d'hygiène et propreté qui durent dans le temps

Le traitement est intégré au processus de fabrication du fil et devient une partie intrinsèque du matériau, augmentant sa résistance aux attaques des micro-organismes. Il n'est pas relâché à l'extérieur.

### Avantages de notre tissu PVC:

- » Protection contre les dommages en bloquant l'adhésion des champignons (mycose), des algues, et des moisissures
- » Excellente solidité à l'action lavante de l'eau ;
- » Bonne résistance à la pourriture;;
- » Empêche la formation de taches colorées d'ordre microbien (tache rose)
- » Compatibilité avec l'environnement.

Notre tissu pvc est **fabriqué à partir de matières premières entièrement conformes aux réglementations nationales et internationales en vigueur**. En particulier, le produit est conforme aux dispositions du règlement REACH n. 1907/2006.

## PVC CON CARACTERÍSTICAS HIGIENIZANTES Y DESINFECTANTES

### --> Sistema de higienización y desinfección

Nuestro tejido de pvc, producido por Ramfil Srl, empresa del Grupo Ramberti, tiene características higienizantes y desinfectantes gracias a un tratamiento antimicrobiano que permite una acción fungistática y bacteriostática evitando el riesgo de infección, eficaz contra un amplio espectro de gérmenes, levaduras y mohos.

En concreto, este aditivo actúa sobre la pared celular del microorganismo, privándole de su capacidad de alimentarse y, por tanto, de crecer y proliferar.

### --> Seguridad de higiene y limpieza que dura a lo largo del tiempo

El tratamiento se integra en el proceso de fabricación del hilo y se convierte en parte intrínseca del material, aumentando su resistencia al ataque de los microorganismos. No se libera al exterior.

### Ventajas de nuestro tejido de PVC:

- » Protección contra daños al bloquear la adhesión de hongos, algas y moho;
- » Excelente resistencia a la acción de lavado del agua;
- » Buena resistencia a la putrefacción;
- » Evita la formación de manchas microbianas de color (mancha rosa);
- » Compatibilidad con el medio ambiente.

Nuestro tejido de pvc está **fabricado con materias primas que cumplen plenamente la normativa nacional e internacional vigente**. En particular, el producto cumple con el Reglamento REACH n.º 1907/2006.





# ROMAGNA



bianco



giallo 1195



beige



giallo 824



rosa



arancio



salmone



rosso



talpa

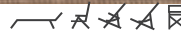

verde



testa di moro

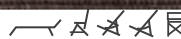

turchese

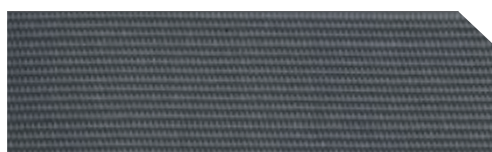

grigio



blu

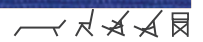

nero

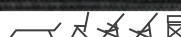

blu cobalto

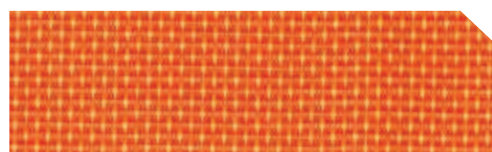

856

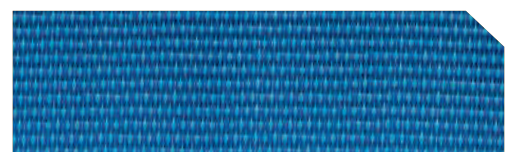

jeans



C333

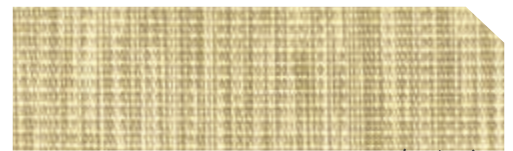

melange beige

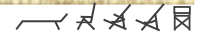



# ROMAGNA

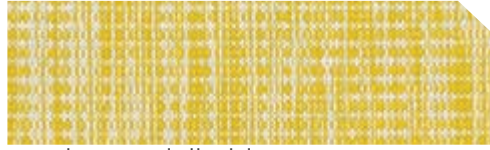

melange giallo bianco

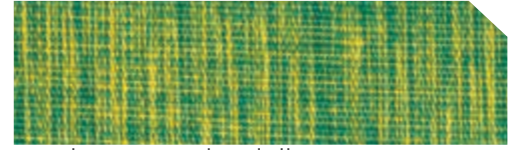

melange verde giallo

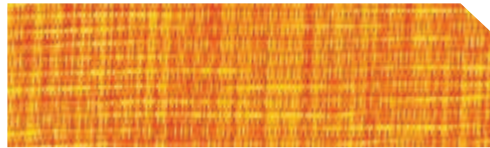

melange sunshine

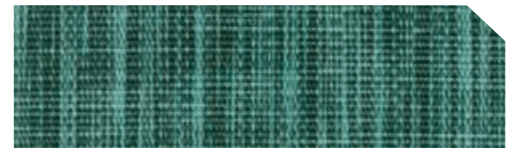

melange verde verde



melange bordeaux

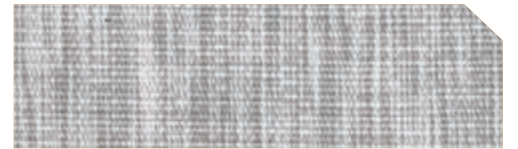

melange grigio mercury

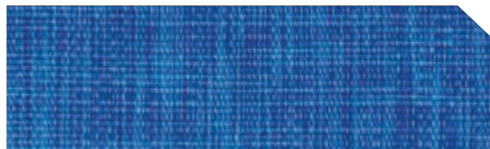

melange blu



melange grigio granito



840



800/F



841



801/F



842



805/F



843



119



846

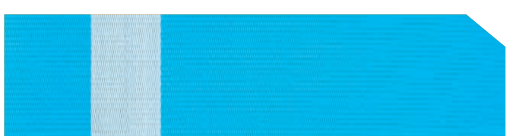

848



114



845



# ROMAGNA



860



803



861



804



862



805



863



806



865



808



866



810



867

# RAM

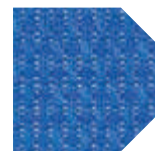
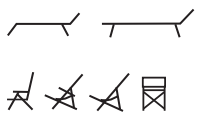

101



102

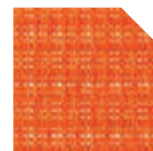

103



104

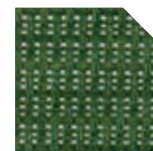

105



000



106



107

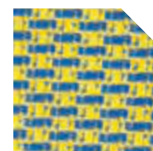

108

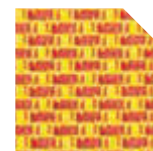

110



111



112

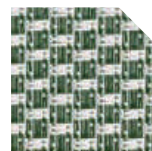

113



114

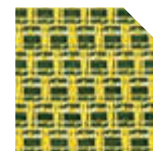

115

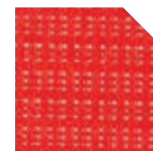

116

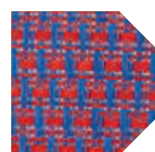

117

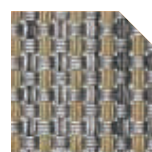

118

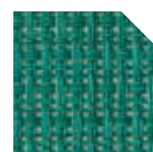

119



120



121



# COR



blanco 833



beige 149

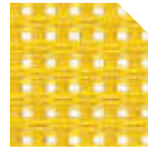

1195

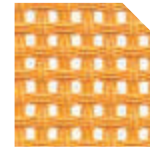

824

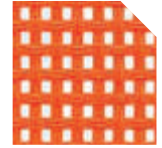

820

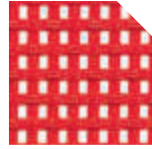

827

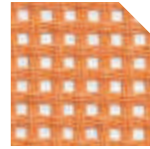

salmone

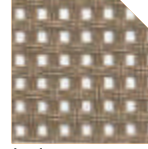

talpa

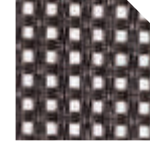

marrone  
testa di moro



rosa

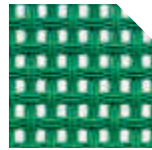

821

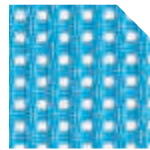

turchese

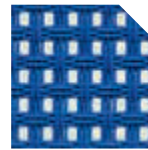

807

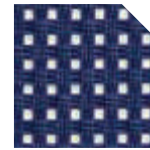

blu cobalto

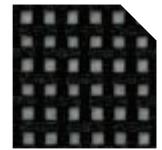

nero

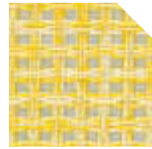

melange  
giallo/bianco

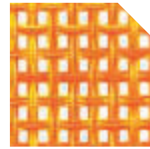

sunshine

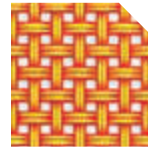

gitano

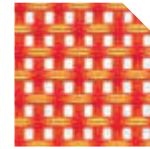

866

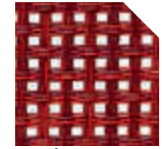

melange  
bordeaux

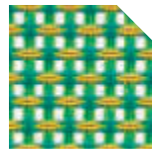

865

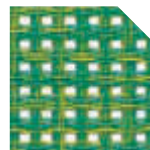

melange  
verde giallo

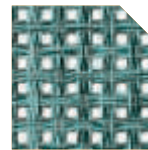

melange  
verde verde



4415

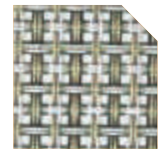

prato

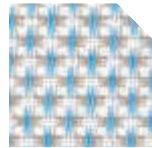

6003

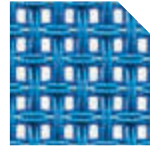

4413

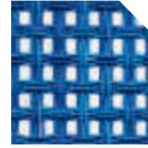

melange blu

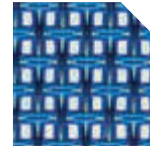

4131

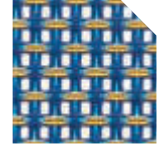

861

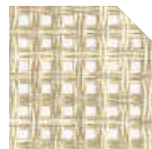

melange beige  
0155

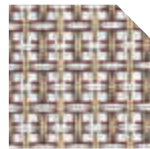

ruggine



sabbia



5526

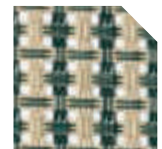

5009



jersey

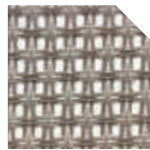

mosquito

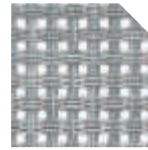

melange  
grigio mercury

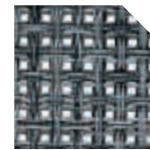

melange  
grigio granito





it / Per i nostri lettini in abbinamento al tessuto COR consigliamo il tettuccio con tessuto ROMAGNA.  
 en / For our sunbeds, in combination with the COR fabric, we suggest the sunshield with ROMAGNA fabric.  
 fr / Pour nos transats, en combinaison avec le tissu COR, nous recommandons le pare-soleil avec le tissu ROMAGNA.  
 es / Para nuestras tumbonas en combinación con el tejido COR recomendamos el dosel con tejido ROMAGNA.

esempi / examples / exemples / ejemplos

lettino / sunbed  
transat / tumbona



mosquito

tettuccio / sunshield  
pare-soleil / dosel



talpa

lettino / sunbed  
transat / tumbona

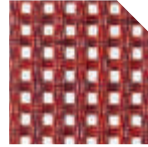

melange  
bordeaux

tettuccio / sunshield  
pare-soleil / dosel



melange bordeaux



melange  
grigio mercury



melange grigio mercury

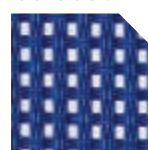

807



blu

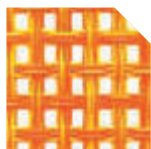

sunshine

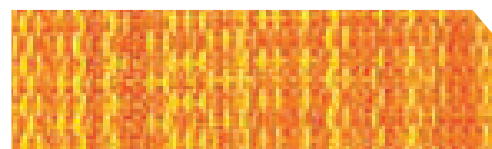

sunshine

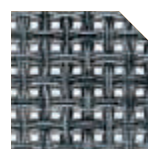

melange  
grigio granito



melange grigio granito

MILANO



bianco



beige

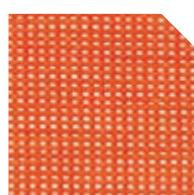

arancio

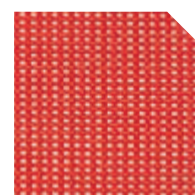

rosso

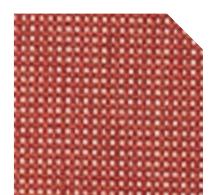

corallo

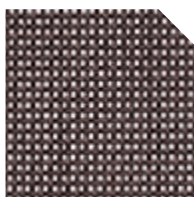

melanzana

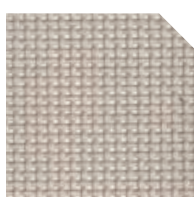

tortora

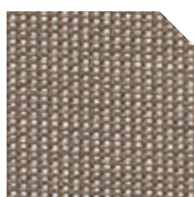

talpa

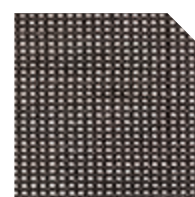

testa di moro

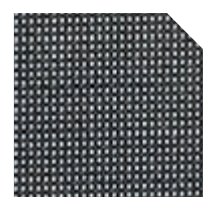

nero

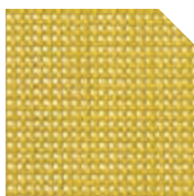

cedro



prato

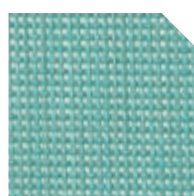

verde acqua

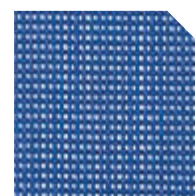

blu

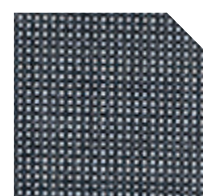

notte

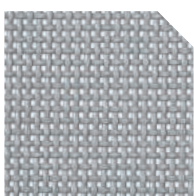

grigio topo

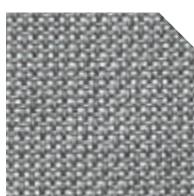

argento

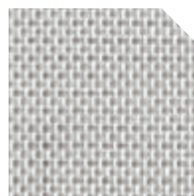

alluminio

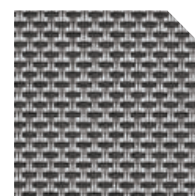

metal

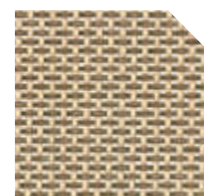

noce



# MOCRILMARE

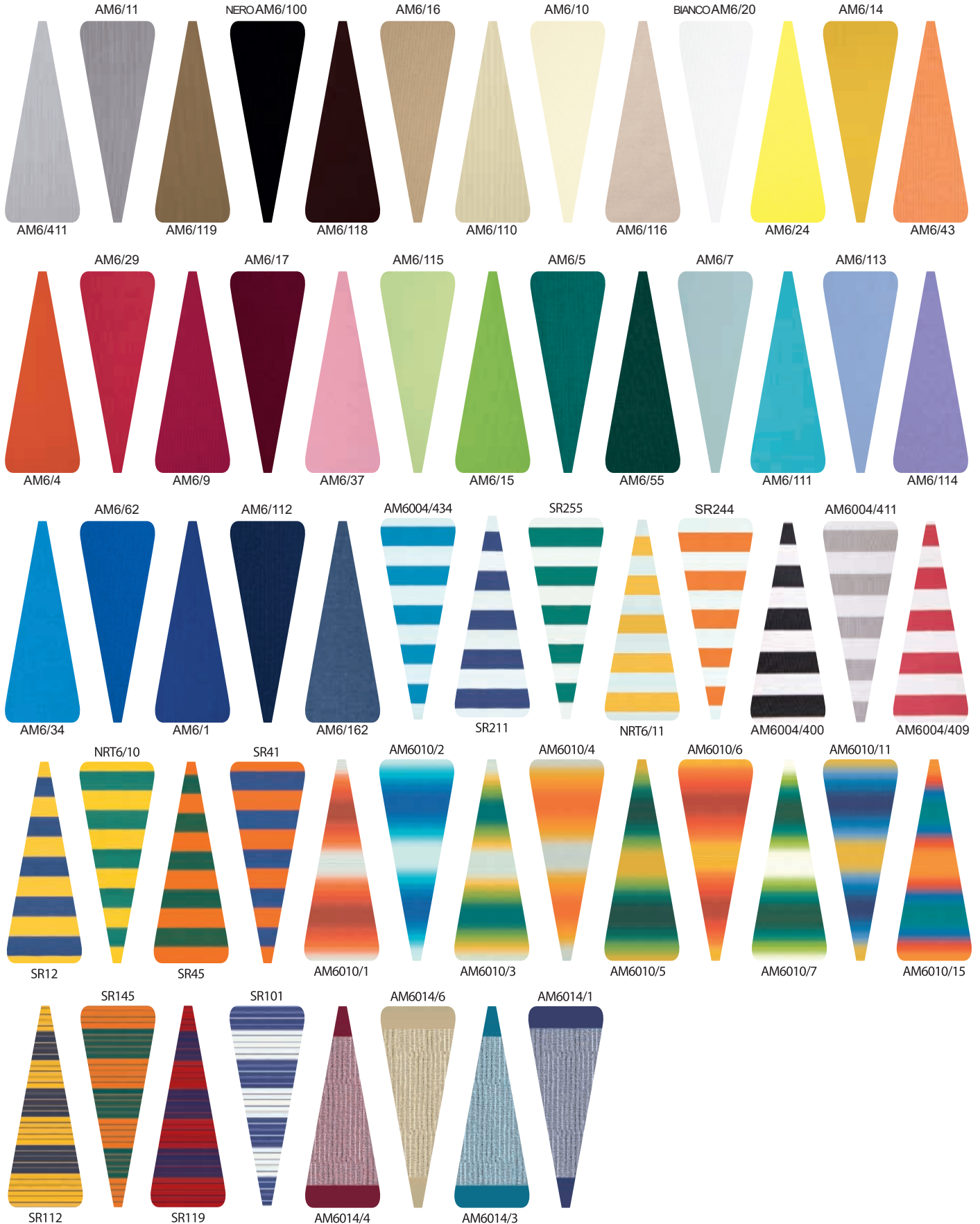

Le immagini dei campioni colore sono indicative e possono subire variazioni cromatiche.  
The images of the color samples are indicative and may have chromatic variations.

Les images des échantillons de couleurs sont indicatives et peuvent subir des variations chromatiques.  
Las imágenes de muestra de color son indicativas y pueden estar sujetas a variaciones de color.



## BORDINI ACRYLIC EDGES

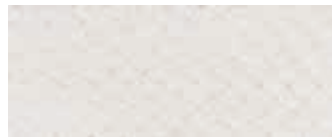

101/G604 BIANCO



408/R035



606



102/G687



409



702/G070



201/Z661



502



703/G316



301/G050



506

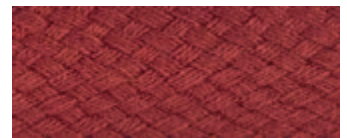

704/Z645



302/G180



509/G252



706/G596



355/G142



510/Z650



707/G038



401/G211



575

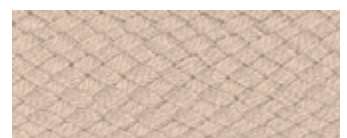

708/G822



402/G209



601/G599



801/Z647

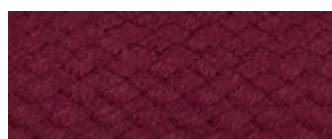

404/G101



603

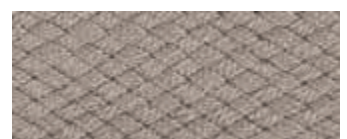

802/G102

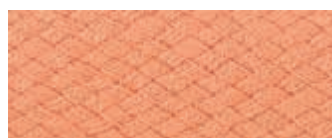

407/G221



605/G245



901/G170 NERO



## PERSONALIZZAZIONE / CUSTOMIZATIONS PERSONNALISATION / PERSONALIZACIÓN

- it / Gli ombrelloni, i lettini, le sdraio, le poltroncine, i cuscini e i materassini filtranti, possono essere personalizzati sia con semplice dicitura con vari caratteri di stampa, sia con la riproduzione del logo dell'acquirente che provvederà ad inviarcì in formato vettoriale. Di seguito alcuni esempi.
- en / The parasols, sunbeds, deck chairs, armchairs, cushions and mattresses, can be customized either with a simple wording with various print characters, or with the reproduction of the customer's own logo which will be sent to us in vector format. Here below some examples.
- fr / Les parasols, les transats, les fauteuils, les chaudières, les coussins et matelas filtrants peuvent être personnalisés soit avec une simple inscription avec différents caractères d'impression, soit avec la reproduction du logo du client qui nous sera transmis en format vectoriel. Ci-dessous quelques exemples.
- es / Las sombrillas, las tumbonas, las sillas, los cojines y las colchonetas filtrantes pueden personalizarse con un simple texto en varias fuentes de impresión o con la reproducción del logotipo del comprador, que se nos debe enviar en formato vectorial. He aquí algunos ejemplos.

### Stampa termosaldada/Heat sealed/Hermosoudés/Impresión termosellada



Carattere standard  
Standard font  
Caractère standard  
Carácter estándar



Carattere personalizzato  
Customized font  
Caractère personnalisé  
Fluente personalizada



Carattere standard per scritte lunghe  
Standard font for long text  
Caractère standard pour les longues inscriptions  
Tipo de letra estándar para textos largos

Colori di stampa:  
Printing colors:  
Couleurs d'impression:  
Colores de impresión:

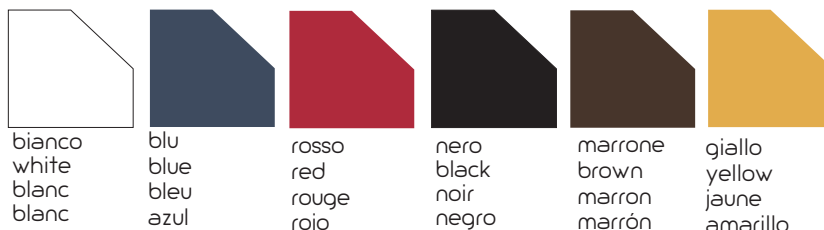

### Stampa serigrafica / Silkscreen printing / Impression en sérigraphie / Serigrafía



## MANUTENZIONE / MAINTENANCE ENTRETIEN / MANTENIMIENTO

it / Nel periodo invernale possiamo curare la manutenzione dei prodotti usurati provvedendo al **cambio delle tele** deteriorate o danneggiate e della componentistica usurata. Naturalmente tale servizio viene svolto su tutta la produzione illustrata nel presente catalogo, in quanto produttori diretti di tutto ciò che viene proposto. Raccomandiamo un contatto entro il mese di settembre per programmare la manutenzione necessaria. Sono disponibili i **ricambi per tutti gli articoli**. Inviateci le vostre fotografie via email.



en In the winter period, we can take care of the maintenance of your products, providing for the **replacement** of deteriorated or damaged **fabrics**, as well as worn spare parts. Obviously this service is carried out on all the production illustrated in this catalog, as we are the producers of all the items which are shown in the same. We recommend you to contact us within the month of September to schedule the necessary maintenance. **Spare parts** are available for all items. Send us your photos by email.

fr / En hiver nous pouvons nous occuper de l'entretien des produits usés en **remplaçant les tissus** détériorés ou abîmés et les composants usés. Naturellement ce service est réalisé sur toute la production illustrée dans ce catalogue, car nous sommes producteurs directs de tout ce qui est proposé. Nous vous recommandons de nous contacter d'ici Septembre pour programmer la maintenance nécessaire. Des **pièces de rechange** sont disponibles pour tous les articles. Envoyez-nous vos photos par email.

es / Durante el invierno, podemos ocuparnos del mantenimiento de los productos desgastados **cambiando las lonas** deterioradas o dañadas y los componentes desgastados. Naturalmente, este servicio se realiza sobre toda la producción ilustrada en este catálogo, ya que somos productores directos de todo lo que se ofrece. Recomendamos contactarnos antes de septiembre para programar el mantenimiento necesario. Las **piezas de repuesto** están disponibles para todos los artículos. Envíanos tus fotos por correo electrónico.



**ERAMBERTI**  
*dal 1918*

*Made in Italy*

2023 FEBBRAIO/FEBRUARY  
2023 FÉVRIER/FEBRERO



**RAMBERTI S.r.l**

via del Tiglio 19  
47822 Santarcangelo  
di Romagna (RN) Italy  
Tel. +39 0541 621206  
Fax +39 0541 620724

[info@ramberti.com](mailto:info@ramberti.com)

[www.ramberti.com](http://www.ramberti.com)

**Ramberti Points:**

-  Via dei Fornai 19 - 76121 Barletta (BT) - ITALY
-  Via al Piemonte (Polo 90) - 17031 Albenga (SV) - ITALY
-  Via Domenico Federici 11 - 04012 Cisterna di Latina (LT) - ITALY
-  Calle 13 entre 84 y 86 - Playa Miramar Habana - CUBA
-  Beach 182 - Avenida Atlantica - 4125 Rio de Janeiro - BRAZIL