

passionate by  
nature



style selection

# colori colors



neutro  
neutral



bianco C2  
white C2



sabbia  
sandy



tortora  
taupe



cemento  
cement



granito  
granite



nero perla  
pearl black



verde acido  
acid green



ruggine  
rust



terra di siena



avorio  
ivory

## finishings



**opaco**  
matt



**lucido**  
gloss



**light**

## product information



**dimensioni esterne**  
external dimensions



**capacità terra**  
soil capacity



**imballo minimo**  
minimum pack

## good for plants



**HDPE**



**sottovaso abbinato**  
fitting saucer



**kit riserva d'acqua**  
water reserve kit

## easy for sales



**rifinito a mano**  
hand-finished



**vaso abbinato**  
matching pot



**cassetta abbinata**  
matching plant box



**kit fissaggio a terra**  
ground fixing kit



**kit luce montato**  
installed light kit

## display solutions



**coverpallet**







passionate by  
nature

**Immaginiamo soluzioni, abbiniamo colori, plasmiamo forme.  
Ogni giorno cambiamo senza fermarci mai.**

**Ascoltiamo la ragione, ma è la passione che guida le nostre  
scelte per superare la linea delle aspettative.**

**Ciascun prodotto è unico ed è il riflesso di ciò che siamo:  
persone che lavorano con entusiasmo unendo organizzazione  
e intuizione.**

We're always thinking up solutions, forms and matching  
colours. Every day, we're changing, without ever stopping.

We listen to reason, but it is passion that guides our choices  
to surpass expectations.

Every product is unique and reflects what we are: a team that  
works enthusiastically, combining organization and intuition.



## benvenuti tra le pagine del nostro catalogo

abbiamo pensato a spunti e suggestioni che ruotano attorno ad un mondo a noi tanto caro, quello dei giardini e delle ambientazioni da arredare con prodotti funzionali e decorativi.

Ci trovi anche on line su [www.euro3plast.com](http://www.euro3plast.com)

## welcome to our catalogue

we have thought up some ideas that focus on a world very dear to us: a world of gardens and settings to furnish with functional and decorative products.

Visit us at [www.euro3plast.com](http://www.euro3plast.com)

PASSIONATE BY NATURE



## Lasciatevi appassionare dai nostri articoli

<b>company profile</b> . . . . .	6
<b>tecnologie / technologies</b> . . . . .	16
<b>certificazioni / certifications</b> . . . . .	18
<b>servizi / services</b> . . . . .	19
<b>style selection</b> . . . . .	20
<b>avvertenze / warnings</b> . . . . .	88
<b>indice generale / general index</b> . . . . .	94

Get carried away  
by our articles



**Dal 1974 concentriamo il nostro entusiasmo sull'oggi:  
l'unico tempo a nostra disposizione per ascoltare, creare,  
innovare e produrre.**

Since 1974 we've been concentrating our enthusiasm on  
"now": the only time at our disposal for listening, creating,  
innovating and making.

# Il futuro inizia nel cuore e nella testa

Oggi, più che mai, scegliamo con attenzione  
cosa realizzare per esprimere uno stile  
sempre originale e coerente.

Raccogliamo idee e fissiamo obiettivi  
ascoltando e interpretando le ispirazioni  
che ci giungono dalle persone.

---

Today, more than ever, we carefully choose  
what to make to express a style  
that is always original and consistent.

We gather ideas and set goals  
listening and interpreting the inspirations  
that come to us from people.

## The future begins in the heart and head



PASSIONATE BY NATURE

# THINK GREEN

## Our ECO-FRIENDLY manifesto



Crediamo in un mondo sostenibile, trattiamo l'ambiente con il rispetto dovuto al nostro pianeta e alle future generazioni. Ci impegnamo ad attuare processi produttivi che minimizzino gli sprechi e favoriscano il riciclo. Siamo attenti a rispettare la natura e sensibilizziamo il nostro personale a fare la raccolta differenziata e ad evitare l'acquisto di prodotti usa e getta.

We believe in a sustainable world, and treat the environment with the respect we owe to our planet and future generations. We're committed to implementing manufacturing processes that minimize waste and promote recycling. And we take care over respecting nature and enhancing awareness among our staff about recycling, and avoiding buying disposable products.



## OUR GREEN SOUL...



**Impianti con sistema di gestione ambientale**  
Plant and equipment with environmental management system



**Imballi riciclabili**  
Recyclable packaging



**Prodotti riciclabili al 100%**  
100% recyclable products



**Sfridi rigenerati in materia prima**  
Waste regenerated into raw material



**ISO 14001:2015**  
**La nostra garanzia nei confronti dell'ambiente**  
ISO 14001:2015  
Our guarantee for the environment



**Materie prime e masterbatch privi di metalli pesanti**  
Raw materials and masterbatches free of heavy metals

...IS OUR COMMITMENT  
FOR A BETTER PLANET



# È scritto nel nostro DNA It's written in our genes



## Qualità

I nostri prodotti comunicano la cura che mettiamo in ogni singolo dettaglio.

---

Our products communicate the care we take over tiny details.

## Quality

## Affidabilità

Dedichiamo tempo e impegno per assicurare massimi livelli di servizio a tutti i nostri clienti.

---

We devote time and commitment to ensuring the highest level of service to all our customers.

## Reliability

## Innovazione

La tecnologia non come fine, ma come mezzo privilegiato per esprimere al meglio la creatività.

---

Technology not as an end but as a privileged means of expressing creativity in the best possible way.

## Innovation

1974 

### Le radici

Iniziamo a produrre i primi articoli per la casa.

### The origins

We begin to manufacture the first items for the home.

1980 

### Costruzione del mercato

Molti dei clienti incontrati nei primi anni '80 sono tutt'oggi al nostro fianco.

### Market building

A high percentage of our customers from the early '80 is still with us today.

1983 

### La svolta

Iniziamo a muoverci con maggior determinazione all'interno del settore garden con la produzione di vasi, cassette e fioriere.

### The turning point

We begin to make way with more determination in the garden sector, producing pots and planters.

1992 

### L'innovazione

Siamo tra i primi nel settore ad affiancare al tradizionale metodo ad iniezione la produzione rotazionale, innovando notevolmente le forme e le dimensioni dei nostri prodotti.

### The innovation

We are among the first in the sector to combine the traditional injection method with rotational production, thereby significantly innovating the shapes and sizes of our products.

2004 

### Nuova sede

Complesso dove si trovano entrambe le linee produttive, il magazzino, gli uffici e lo showroom.

### New Headquarters

A complex that houses both our production lines, the warehouse, offices and showroom.

2014 

### I nostri 40 anni

È un traguardo e una ripartenza. Un momento per celebrare la creatività di un gruppo che non ha mai smesso di interpretare le potenzialità della plastica.

### Our first 40 years

An anniversary and a new outlook. A time to celebrate the creativity of a group that has never stopped interpreting the potential of plastic.

L'obiettivo  è scegliere di essere originali, sempre!

La vera sfida, oggi, è comunicare le nostre idee e anticipare i gusti di un mercato che cambia sempre più velocemente.

The goal is to choose to be original, always!

The real challenge today is to communicate our ideas and anticipate the demands of a market that is changing at an ever-faster pace.

97%

livello di servizio garantito al cliente

guaranteed customer service level

5%

percentuale del fatturato investito  
nella ricerca e comunicazione di  
nuovi prodotti

percentage of turnover invested  
in researching and communicating  
new products

3.600.000 kg

materia prima lavorata all'anno

raw materials processed per year

120

diverse tipologie di colori e finiture

different types of colours  
and finishes

magazzino  
warehouse

magazzino  
warehouse

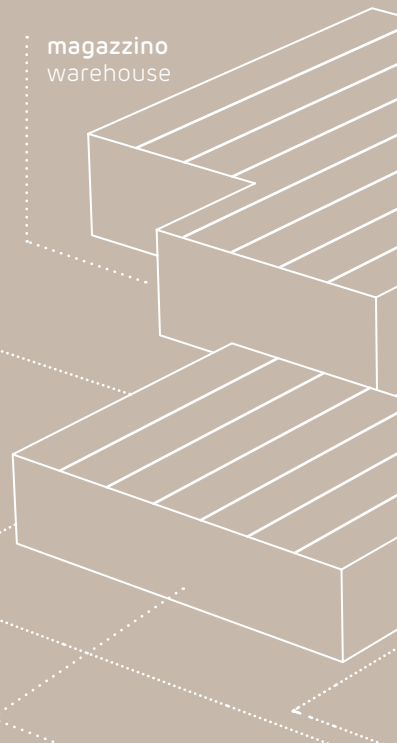

32.000 mq

superficie produttiva dell'azienda

manufacturing surface  
of the company



60

mercati differenti

different markets

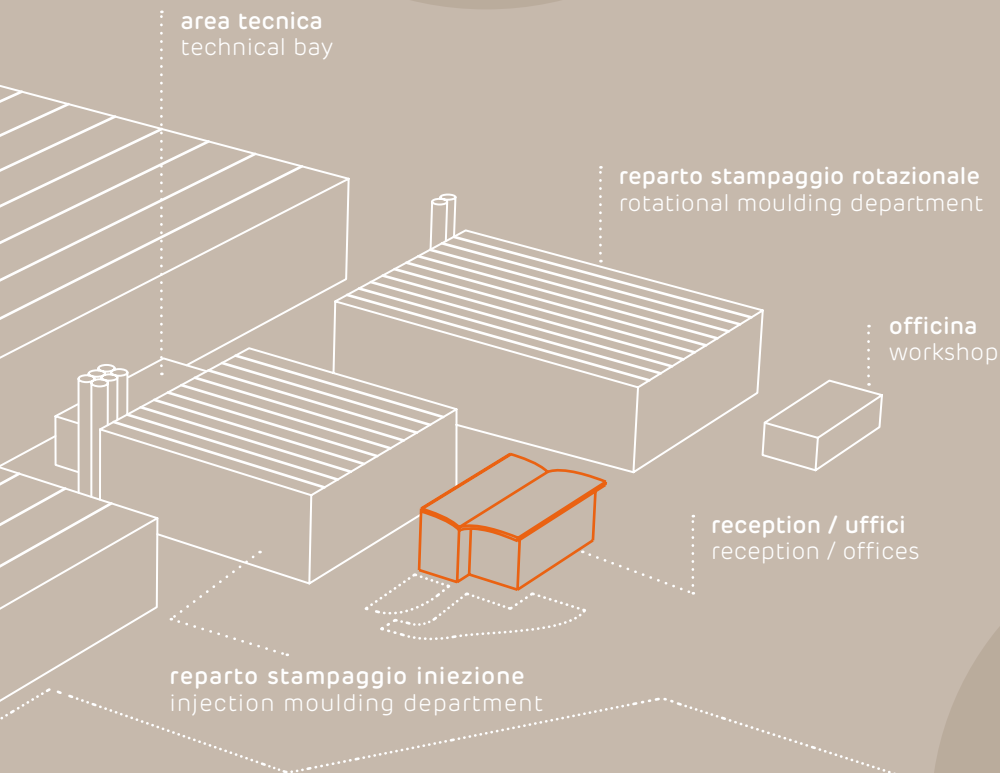

12  
13

3

sistemi di gestione:

- qualità
- ambiente
- sicurezza

management systems:

- quality
- environment
- safety

7.800.000

pezzi prodotti all'anno

items produced per year

# I nostri valori

# Our values



## Qualità

Cura e attenzione  
del dettaglio  
in ogni ambito.

Care and attention  
to detail  
in every sphere.

## Quality



## Il Cliente

"La nostra più grande risorsa  
è il cliente! Tratta ogni cliente  
come se fosse l'unico."  
(Laurice Leitao)

"Our greatest asset are  
our customers! Treat every one of  
them as if they were the only one."  
(Laurice Leitao)

## Customer



## Lavoro di gruppo

Insieme possiamo  
fare di più!

Together  
we can do more!

## Teamwork

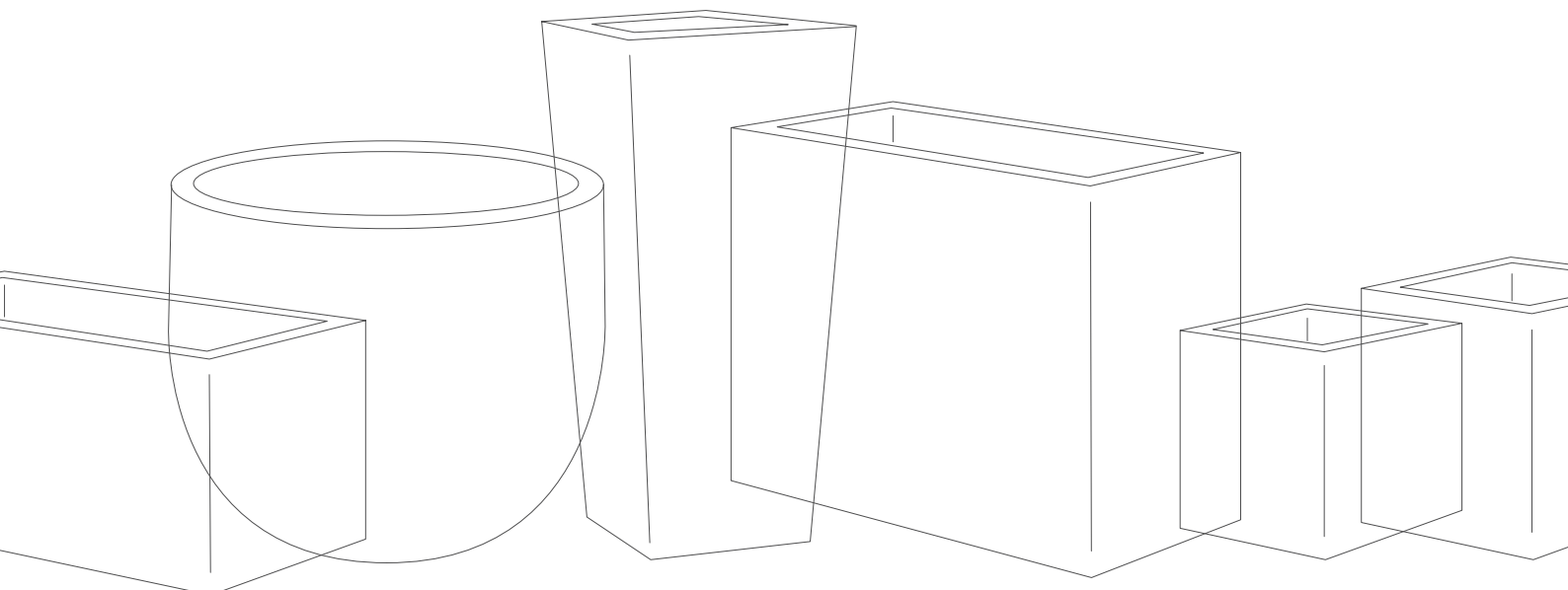



## Passione

**"Scegli il lavoro che ami  
e non lavorerai neppure  
un giorno in tutta la tua vita"  
(Confucio)**

---

"Choose a job you love  
and will never have to work  
a day in your life".  
(Confucius)

## Passion



## Innovazione

**Passione e curiosità  
guidano l'innovazione:  
un miglioramento continuo che  
distingue il leader dal follower.**

---

Passion and curiosity drive  
innovation: ongoing improvement  
that sets the leader apart  
from the followers.

## Innovation

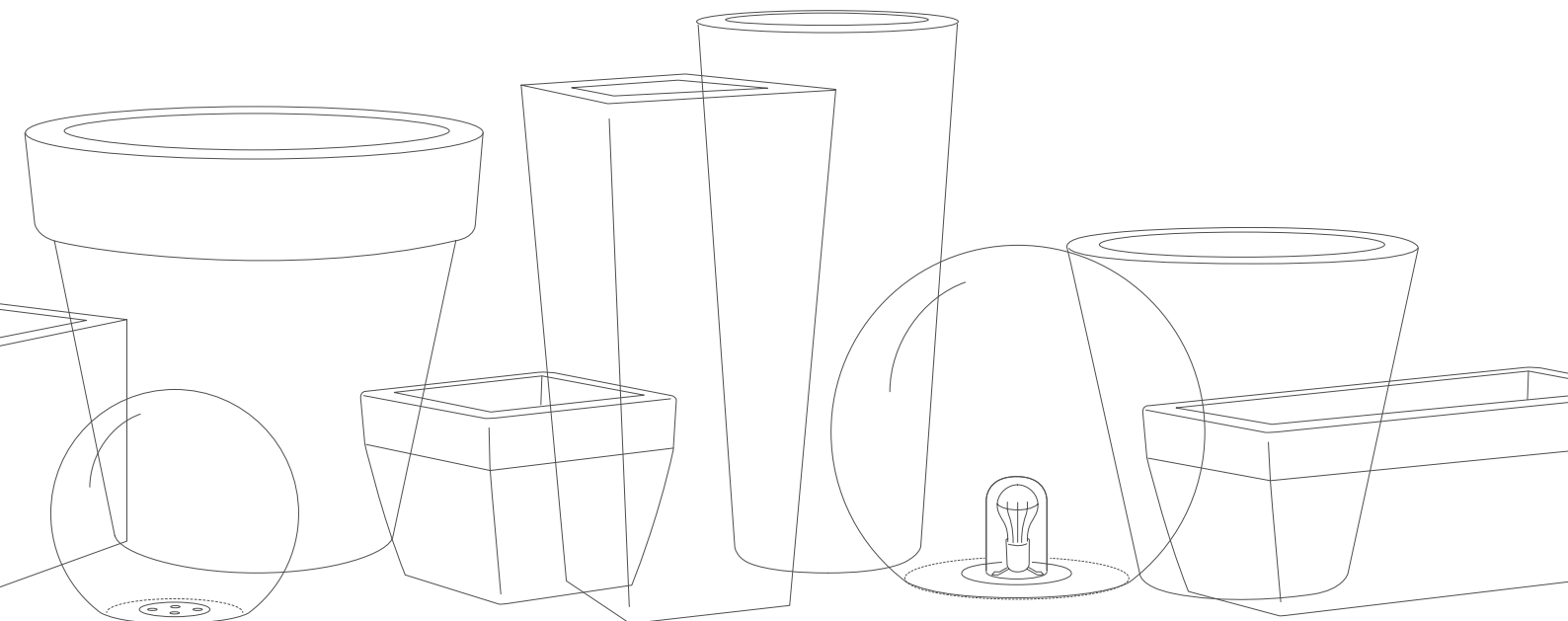



## Stampaggio iniezione Injection moulded

Attraverso la tecnologia di stampaggio ad iniezione è possibile realizzare oggetti di materiale plastico su grande scala. Il nostro processo di lavorazione si avvale degli ultimi ritrovati tecnologici in materia di stampi e di presse. Durante il ciclo di stampaggio, il materiale scende dalla tramoggia, viene fuso e poi iniettato nell'impronta dello stampo grazie ad un pistone che scorre nella camera di fusione. Quindi, il prodotto viene estratto, dopo una fase di raffreddamento che lo solidifica plasmandolo secondo la forma dello stampo.

---

Injection moulding technology allows for quality plastic items to be manufactured on a large scale. Our process exploits the latest mould and machine technology. During the moulding cycle, the material descends from the hopper, is made molten and then injected into the mould impression by a piston that slides into the melting chamber. Then, the product is extracted after a cooling phase that solidifies it, shaping it to the mould.







## Stampaggio rotazionale Rotational moulded

Con lo stampaggio rotazionale si possono produrre oggetti di ottima rifinitura, anche di dimensioni notevoli. Le forme sono forgiate da stampi in alluminio dove il materiale in polvere viene inserito, poi riscaldato e fuso all'interno di un forno. Durante la fase di riscaldamento, il ciclo di stampaggio prevede una rotazione lenta, per distribuire il materiale sulle pareti in modo uniforme. Successivamente, il prodotto viene raffreddato e poi estratto dallo stampo. Le peculiarità di questa tecnologia consente di realizzare articoli di grande creatività artistica.

Rotational moulding can be used to produce even large items with an excellent finish. The shapes are forged from aluminium moulds where the powder material is inserted, then heated and melted inside an oven. During the heating phase, the moulding cycle involves a slow rotation to distribute the material evenly on the walls. The product is then cooled and removed from the mould. The particular features of this technology allow items of great artistic creativity to be created.





## Abbiamo scelto di seguire normative severe, per garantire non solo la soddisfazione dei clienti, ma anche il rispetto dell'ambiente e la salvaguardia della salute.

We have chosen to follow strict regulations to ensure not only customer satisfaction, but also respect for the environment and the protection of health.



### Sistema di gestione qualità (UNI EN ISO 9001:2015)

Introdotta nel 1997 per affermare la serietà commerciale dei nostri prodotti ed esaudire le esigenze dei nostri clienti, segue la Norma UNI EN ISO 9001:15 ed è certificata dall'Ente DNV GL.

### Quality management system (UNI EN ISO 9001:2015)

Introduced in 1997 to confirm the commercial soundness of our products and to meet our customers' requirements, our Quality Management System complies with the UNI EN ISO 9001:15 Standard and is certified by DNV GL.



### Sistema di gestione ambientale (UNI EN ISO 14001:2015)

Siamo da sempre sensibili alle tematiche ambientali: nel 2001, a conferma del nostro impegno, abbiamo adottato anche un Sistema di Gestione Ambientale certificato dell'Ente DNV GL secondo quanto previsto dalla Norma UNI EN ISO 14001:15.

### Environment management system (UNI EN ISO 14001:2015)

We have always been sensitive to environment issues: in 2001, in order to confirm our commitment, we also adopted an Environment Management System certified by DNV GL in accordance with the provisions of the UNI EN ISO 14001:15 Standard.



### Sistema di gestione della sicurezza (ISO 45001:2018)

Il nostro impegno per la sicurezza dei lavoratori sui luoghi di lavoro non si ferma mai. A tal proposito l'azienda ha allineato nel 2019 il proprio Sistema di Gestione della Sicurezza (già certificato nel 2013 secondo la norma OSHAS 18001) alla nuova Norma ISO 45001:2018, garantendo in questo modo il costante miglioramento delle attività svolte dai lavoratori nel rispetto della legislazione vigente.

### Safety management system (ISO 45001:2018)

We have always been consistent in our commitment to safety at the workplace. And as testament to our attention, in 2019 we have aligned our Safety Management System (already certified in 2013 according to OHSAS 18001) to the new ISO 45001:2018, a standard which approves our propensity to ongoing improvement in the tasks our personnel perform, in keeping with current laws.

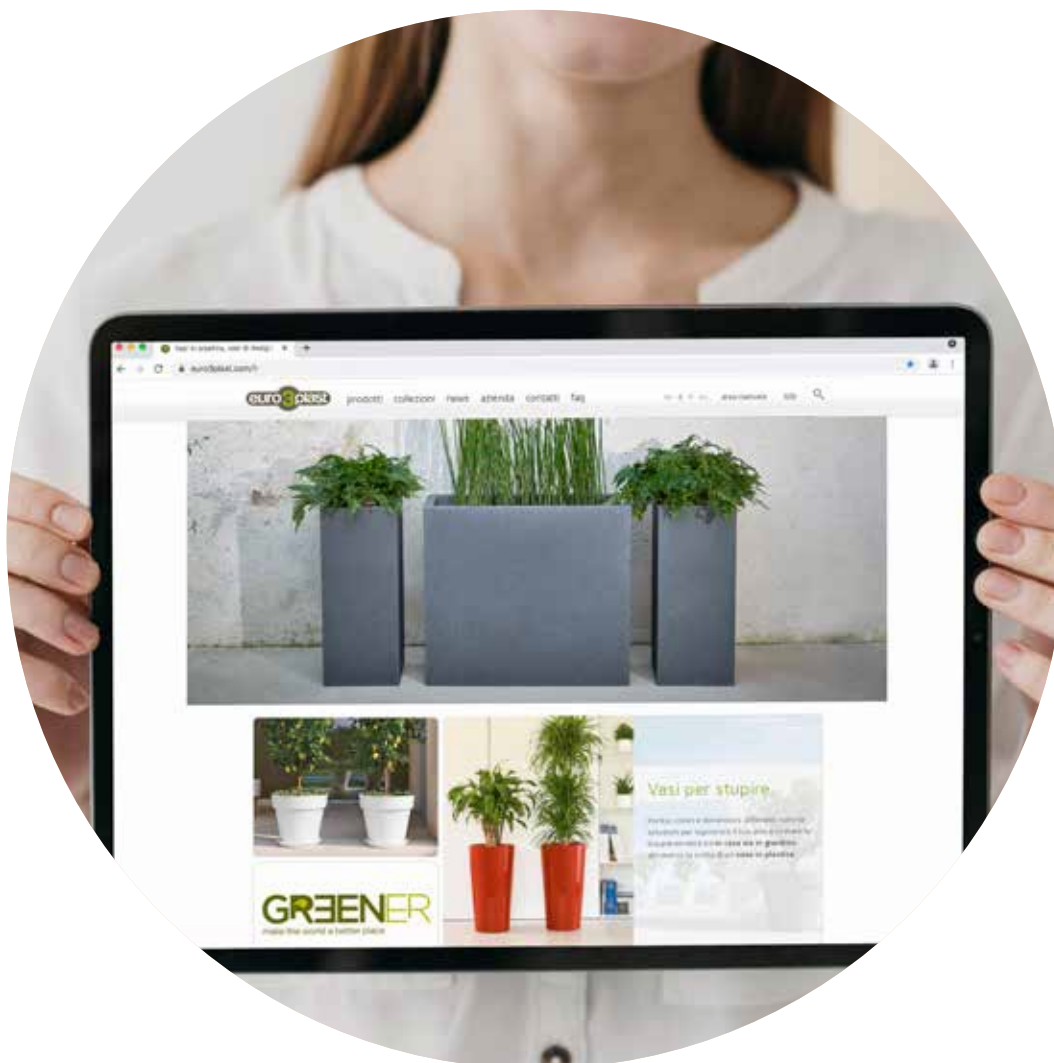

## Noi con Voi per un dialogo sempre aperto

Ci raccontiamo e ascoltiamo perché dalla comunicazione reciproca nascono sempre le cose migliori.

## Us with You for an always-open dialogue

We open up about ourselves and listen. Because the best things come from mutual consultation.

Follow us!



euro3plast



euro3plast









# style

Una tecnologia che realizza prodotti singoli e molto resistenti, ha generato questa vasta gamma di vasi e complementi d'arredo. La rifinitura manuale che caratterizza tutti gli articoli, contribuisce a renderli curati in ogni dettaglio.

A technology that makes products both unique and highly-resistant has generated this wide range of pots and furnishing items. All items are hand finished, making them refined down to the smallest detail.



100%  
Recyclable



Lightweight



Antishock



U.V.  
Resistant



Resistant





kube | cassetta • plant box

art.	size						
2601	cm 80	(cm 80 x 30 x 30 h)	L 32	A4327	2 x A4629	1	     
2548	cm 100	(cm 100 x 40 x 40 h)	L 73	A4278	2 x A4629	1	     

kube | cassetta con ruote • plant box with castors

art.	size					
2753	cm 80	(cm 80 x 30 x 31 h)	L 32	A4327	1	     
2590	cm 100	(cm 100 x 40 x 41 h)	L 73	A4278	1	     



# kube

good for plants



lلدpe



kit riserva d'acqua  
water reserve kit



easy for sales



rifinito a mano  
hand-finished



cassetta vaso abbinati  
matching plant box pot



kit fissaggio a terra  
ground fixing kit

display solutions



cover pallet

22  
23

## kube | vaso • pot

art.	size						
2538	cm 30	(cm 30 x 30 x 30 h)	L 9	A4255	A4629	1	
2514	cm 40	(cm 40 x 40 x 40 h)	L 22	A4241	A4629	1	
2515	cm 50	(cm 50 x 50 x 50 h)	L 45	A4242	A4629	1	

## kube | vaso con ruote • pot with castors

art.	size					
2587	cm 30	(cm 30 x 30 x 31 h)	L 9	A4255	1	
2588	cm 40	(cm 40 x 40 x 41 h)	L 22	A4241	1	
2589	cm 50	(cm 50 x 50 x 51 h)	L 45	A4242	1	

anche con  
ruote nascoste  
also with  
hidden castors









# kube

good for plants



lIdpe



kit riserva d'acqua  
water reserve kit



easy for sales



rifinito a mano  
hand-finished



cassetta vaso abbinati  
matching plant box pot



kit fissaggio a terra  
ground fixing kit

display solutions



cover pallet

24  
25

kube | vaso • pot











S4

anche con  
ruote nascoste  
also with  
hidden castors





kube gloss | vaso • pot

art.	size						
*2583	cm 30	(cm 30 x 30 x 30 h)	L 9	A4255	A4629	1	 
*2584	cm 40	(cm 40 x 40 x 40 h)	L 22	A4241	A4629	1	 
*2585	cm 50	(cm 50 x 50 x 50 h)	L 45	A4242	A4629	1	 

\* per quantitativi minimi • for minimum orders



# kube

---

## gloss

good for **plants**



Il dpe



kit riserva d'acqua  
water reserve kit

easy for **sales**



rifinito a mano  
hand-finished





kit fissaggio a terra  
ground fixing kit





kube mini | cassetta • plant box

art.	size					
2828	<b>cm 50</b>	(cm 50 x 18 x 18 h)	L 9,0	A4629	1	 
2776	<b>cm 60</b>	(cm 60 x 20 x 20 h)	L 11,5	A4629	1	 

# kube mini

good for plants



IlDpe



easy for sales



rifinito a mano  
hand-finished



kit fissaggio a terra  
ground fixing kit



28  
29

## kube mini | vaso • pot

art.	size					
2827	<b>cm 18</b>	(cm 18 x 18 x 18 h)	L 2,7	A4629	1	
2634	<b>cm 20</b>	(cm 20 x 20 x 20 h)	L 2,7	A4629	1	



**kube mini** | cassetta • plant box with mini led light kit (indoor)

art.	size		
2791	cm 60	(cm 60 x 20 x 20 h)	1 

# kube mini

## light

material



HDPE



easy for sales



rifinito a mano  
hand-finished



kit luce montato  
installed light kit



30  
31

kube mini | vaso • pot with mini led light kit (indoor)

art.	size			
2783	cm 20	(cm 20 x 20 x 20 h)	1	(98)



















**kube high | cassetta alta • high plant box**

art.	size						
2602	cm 80	(cm 80 x 30 x 70 h)	L 32,0	A4327	2 x A4629	1	     
2586	cm 100	(cm 100 x 40 x 70 h)	L 77,5	A4278	2 x A4629	1	     

**kube high | cassetta alta con ruote • high plant box with castors**

art.	size					
2754	cm 80	(cm 80 x 30 x 71 h)	L 32,0	A4327	1	     
2591	cm 100	(cm 100 x 40 x 71 h)	L 77,5	A4278	1	     

# kube high

good for plants



lلدpe



kit riserva d'acqua  
water reserve kit



easy for sales



rifinito a mano  
hand-finished



cassetta vaso abbinati  
matching plant box pot



kit fissaggio a terra  
ground fixing kit

display solutions



cover pallet

32  
33

## kube high | vaso alto • high pot

art.	size						
2611	cm 30	(cm 30 x 30 x 70 h)	L 9	A4255	A4629	1	
2612	cm 40	(cm 40 x 40 x 70 h)	L 23	A4241	A4629	1	

## kube high | vaso alto con ruote • high pot with castors

art.	size					
2733	cm 30	(cm 30 x 30 x 71 h)	L 9	A4255	1	
2734	cm 40	(cm 40 x 40 x 71 h)	L 23	A4241	1	

anche con  
ruote nascoste  
also with  
hidden castors



PASSIONATE BY NATURE





# kube high

good for plants



lIdpe



kit riserva d'acqua  
water reserve kit



easy for sales



rifinito a mano  
hand-finished



cassetta vaso abbinati  
matching plant box pot



kit fissaggio a terra  
ground fixing kit

display solutions



cover pallet

34  
35

kube high | vaso alto • high pot S4

kube high | cassetta alta • high plant box S4

anche con  
ruote nascoste  
also with  
hidden castors







# kube high

## good for plants



lIdpe



kit riserva d'acqua  
water reserve kit



## easy for sales



rifinito a mano  
hand-finished



cassetta vaso abbinati  
matching plant box pot



kit fissaggio a terra  
ground fixing kit

## display solutions



cover pallet



kube high | vaso alto • high pot 

kube high | cassetta alta • high plant box 



anche con  
ruote nascoste  
also with  
hidden castors



**kube high | cass. alta • high plant box light (indoor)**

art.	size				
2745	cm 80	(cm 80 x 30 x 70 h)	2 x A4629	1	98
2701	cm 100	(cm 100 x 40 x 70 h)	2 x A4629	1	98

**kube high | cass. alta • high plant box light (outdoor)**

art.	size				
*2746	cm 80	(cm 80 x 30 x 70 h)	2 x A4629	1	98
*2702	cm 100	(cm 100 x 40 x 70 h)	2 x A4629	1	98

\* con canaletta di scolo • with drainage tube

# kube high

## light

material



lldpe



easy for sales



rifinito a mano  
hand-finished



cassetta vaso abbinati  
matching plant box pot



kit fissaggio a terra  
ground fixing kit



kit luce montato  
installed light kit



38  
39

kube high | vaso alto • high pot light (indoor)

art.	size				
2737	cm 30	(cm 30 x 30 x 70 h)	A4629	1	98
2741	cm 40	(cm 40 x 40 x 70 h)	A4629	1	98

kube high | vaso alto • high pot light (outdoor)

art.	size				
2738	cm 30	(cm 30 x 30 x 70 h)	A4629	1	98
*2742	cm 40	(cm 40 x 40 x 70 h)	A4629	1	98

\* con canaletta di scolo • with drainage tube





kube high slim | cassetta alta • high plant box

art.	size						
*2777	cm 80	(cm 80 x 25 x 70 h)	L 32	A4327	2 x A4629	1	

\* nuovo colore • new color





# kube high slim

## good for plants



lIdpe



kit riserva d'acqua  
water reserve kit



## easy for sales



rifinito a mano  
hand-finished



cassetta vaso abbinati  
matching plant box pot



kit fissaggio a terra  
ground fixing kit







## display solutions



cover pallet

40  
41

### kube high slim | vaso alto • high pot

art.	size						
*2788	cm 25	(cm 25 x 25 x 70 h)	L 8,8	A4255	A4629	1	     

\* nuovo colore • new color

PASSIONATE BY NATURE





# kube high slim

## good for plants



HDPE



kit riserva d'acqua  
water reserve kit



## easy for sales



rifinito a mano  
hand-finished



cassetta vaso abbinati  
matching plant box pot



kit fissaggio a terra  
ground fixing kit

## display solutions





cover pallet







**kube high slim | cass. alta • high plant box light (indoor)**

art.	size				
2792	cm 80	(cm 80 x 25 x 70 h)	2 x A4629	1	98

**kube high slim | cass. alta • high plant box light (outdoor)**

art.	size				
*2793	cm 80	(cm 80 x 25 x 70 h)	2 x A4629	1	98

\* con canaletta di scolo • with drainage tube



# kube high slim

## light

material



lhdpe

easy for sales



**rifinito a mano**  
hand-finished



**cassetta vaso abbinati**  
matching plant box pot



**kit fissaggio a terra**  
ground fixing kit



**kit luce montato**  
installed light kit

44  
45

**kube high slim | vaso alto • high pot (indoor)**

art.	size				
2796	cm 25	(cm 25 x 25 x 70 h)	A4629	1	98

**kube high slim | vaso alto • high pot light (outdoor)**

art.	size				
2797	cm 25	(cm 25 x 25 x 70 h)	A4629	1	98



kube tower | cassetta alta • high plant box

art.	size						
*2825	cm 70	(cm 70 x 30 x 90 h)	L 29	A4327	2 x A4629	1	     

\* nuovo colore • new color



# kube tower

## good for plants



lIdpe



kit riserva d'acqua  
water reserve kit



## easy for sales



rifinito a mano  
hand-finished



cassetta vaso abbinati  
matching plant box pot



kit fissaggio a terra  
ground fixing kit

## display solutions



cover pallet

46  
47

### kube tower | vaso alto • high pot

art.	size						
*2826	cm 30	(cm 30 x 30 x 90 h)	L 10	A4255	A4629	1	C2 G9 87 S3 S4 E5

\* nuovo colore • new color





**kube tower | cass. alta • high plant box light (indoor)**

art.	size				
2835	cm 70	(cm 70 x 30 x 90 h)	2 x A4629	1	98

**kube tower | cass. alta • high plant box light (outdoor)**

art.	size				
*2836	cm 70	(cm 70 x 30 x 90 h)	2 x A4629	1	98

\* con canaletta di scolo • with drainage tube





# kube tower

## light

material



lIdpe

easy for sales



rifinito a mano  
hand-finished



cassetta vaso abbinati  
matching plant box pot



kit fissaggio a terra  
ground fixing kit



kit luce montato  
installed light kit

48  
49

kube tower | vaso alto • high pot light (indoor)

art.	size				
2831	cm 30	(cm 30 x 30 x 90 h)	A4629	1	98

kube tower | vaso alto • high pot light (outdoor)

art.	size				
2832	cm 30	(cm 30 x 30 x 90 h)	A4629	1	98



kube | panca • bench

art.	size				
2549	cm 100	(cm 100 x 40 x 40 h)	2 x A4629	1	©2 87 E5

# kube

material



lhdpe

easy for sales



rifinito a mano  
hand-finished



kit fissaggio a terra  
ground fixing kit



50  
51

kube | sgabello • stool

art.	size				
2532	<b>cm 40</b>	(cm 40 x 40 x 40 h)	A4629	1	
*2533	<b>cm 50</b>	(cm 50 x 50 x 50 h)	A4629	1	

\* per quantitativi minimi • for minimum orders





**kuba | panca • bench light (indoor)**

art.	size				
2755	cm 100	(cm 100 x 40 x 40 h)	2 x A4629	1	98

**kuba | panca • bench light (outdoor)**

art.	size				
2756	cm 100	(cm 100 x 40 x 40 h)	2 x A4629	1	98

# kube

## light

material



lldpe



easy for sales



rifinito a mano  
hand-finished



kit fissaggio a terra  
ground fixing kit



kit luce montato  
installed light kit



52  
53

kube | sgabello • stool light (indoor)

art.	size				
2705	cm 40	(cm 40 x 40 x 40 h)	A4629	1	98
2708	cm 50	(cm 50 x 50 x 50 h)	A4629	1	98

kube | sgabello • stool light (outdoor)

art.	size				
2706	cm 40	(cm 40 x 40 x 40 h)	A4629	1	98
2709	cm 50	(cm 50 x 50 x 50 h)	A4629	1	98



**kube mini** | cubo • cube with mini led light kit (indoor)

art.	size		
2784	cm 20	(cm 20 x 20 x 20 h)	1 





# kube mini

---

## light

material



lldpe

easy for **sales**















rifinito a mano  
hand-finished



kit luce montato  
installed light kit



ikon | vaso • pot

art.	size						
2603	Ø 40	(cm 40 x 36 h)	L 23			1	
2604	Ø 50	(cm 50 x 44 h)	L 47			1	
2605	Ø 60	(cm 60 x 53 h)	L 82	1 x A4631		1	
2896	Ø 70	(cm 70 x 62 h)	L 130	1 x A4631		1	
2541	Ø 80	(cm 80 x 71 h)	L 202	1 x A4631		1	
2542	Ø 100	(cm 100 x 89 h)	L 398	2 x A4631		1	
2543	Ø 120	(cm 120 x 107 h)	L 680	2 x A4631		1	
*2786	Ø 140	(cm 140 x 125 h)	L1066			1	
*2787	Ø 160	(cm 160 x 143 h)	L1594			1	

\* articolo con disponibilità limitata e tempi di produzione lunghi • item with low availability and long production delays



# ikon

## good for plants



lhdpe



sottovaso abbinato  
fitting saucer



## easy for sales



rifinito a mano  
hand-finished



kit fissaggio a terra  
ground fixing kit



## display solutions



cover pallet

56  
57

### ikon | sottovaso • saucer

art.	size			
2607	Ø 50	(cm 36,0 x 3,5 h)	1	C2 M9 G9 S3 S4 87 E5
2608	Ø 60	(cm 42,5 x 4,0 h)	1	C2 M9 G9 S3 S4 87 E5
2897	Ø 70	(cm 50,5 x 4,5 h)	1	C2 M9 G9 S3 S4 87 E5
2598	Ø 80	(cm 56,0 x 5,0 h)	1	C2 M9 G9 S3 S4 87 E5
2599	Ø 100	(cm 71,0 x 6,0h)	1	C2 M9 G9 S3 S4 87 E5
2600	Ø 120	(cm 85,0 x 7,0 h)	1	C2 M9 G9 87 E5
2814	Ø 140	(cm 99,0 x 8,5 h)	1	C2 G9 87 E5
2815	Ø 160	(cm 113,0 x 9,5 h)	1	C2 G9 87 E5

i sottovasi possono essere ordinati solo contestualmente ai vasi cui sono abbinati e in quantità uguale, inferiore o secondo la disponibilità • these saucers may only be ordered at the same time as the pots they are matched to, and in the same or fewer quantities, depending on availability



PASSIONATE BY NATURE



ikon | vaso • pot S3



# ikon

## good for plants



lIdpe



sottovaso abbinato  
fitting saucer



## easy for sales



rifinito a mano  
hand-finished



kit fissaggio a terra  
ground fixing kit

## display solutions



cover pallet





ikon | vaso con fori • pot with holes

art.	size				
*2996	Ø 200	(cm 200 x 178 h)	L 3139	1	Ⓒ2 G9 87 E5

ikon | sottovaso • saucer

art.	size			
3008	Ø 200	(cm 141 x 12 h)	1	Ⓒ2 G9 87 E5

i sottovasi possono essere ordinati solo contestualmente ai vasi cui sono abbinati e in quantità uguale, inferiore o secondo la disponibilità • these saucers may only be ordered at the same time as the pots they are matched to, and in the same or fewer quantities, depending on availability





# ikon

good for plants



lIdpe



sottovaso abbinato  
fitting saucer



easy for sales



rifinito a mano  
hand-finished

60  
61

ikon | vaso con fori chiuso sopra • pot with holes closed on top

art.	size				
*3012	Ø 200	(cm 200x178 h)	L 767	1	   

grande  
dimensione  
large

\* articolo con disponibilità limitata e tempi di produzione lunghi • item with low availability and long production delays

# etria

good for plants



lldpe

easy for sales



rifinito a mano  
hand-finished

display solutions



cover pallet



etria | vaso con doppia parete • pot with double wall

art.	size				
2453	Ø 24 (cm 24 x 20 h)	L 5	1		(C2) (M9) (87) (E5) (45) (69)
2318	Ø 34 (cm 34 x 28 h)	L 14	1		(C2) (M9) (G9) (87) (E5) (45) (69)
2319	Ø 44 (cm 44 x 36 h)	L 30	1		(C2) (M9) (G9) (87) (E5) (45) (69)
2320	Ø 54 (cm 54 x 44 h)	L 56	1		(C2) (M9) (G9) (87) (E5) (45) (69)
2447	Ø 64 (cm 64 x 52 h)	L 86	1		(C2) (M9) (G9) (87) (E5) (45)
2454	Ø 74 (cm 74 x 61 h)	L 131	1		(C2) (M9) (G9) (87) (E5)



# etria uno

good for plants



lldpe



easy for sales



rifinito a mano  
hand-finished

display solutions



cover pallet

62  
63

















etria uno | vaso con singola parete • pot with single wall

art.	size				
2860	Ø 24 (cm 24 x 20 h)	L 6	1		    
2861	Ø 34 (cm 34 x 28 h)	L 18	1		    
2862	Ø 44 (cm 44 x 36 h)	L 39	1		    
2863	Ø 54 (cm 54 x 44 h)	L 73	1		    
2864	Ø 64 (cm 64 x 52 h)	L 123	1		    
2865	Ø 74 (cm 74 x 61 h)	L 192	1		    





ilie | vaso • pot

art.	size						
2497	Ø 37	(cm 37 x 75 h)	L 13	A4256		1	  
2498	Ø 42	(cm 42 x 90 h)	L 19			1	  
2415	Ø 47	(cm 47 x 98 h)	L 26	A4239	A4631	1	  
2506	Ø 57	(cm 57 x 126 h)	L 54	A4240		1	  

# ilie

good for **plants**



lلدpe



kit riserva d'acqua  
water reserve kit



easy for **sales**



rifinito a mano  
hand-finished







kit fissaggio a terra  
ground fixing kit





ilie gloss | vaso • pot

art.	size						
2579	Ø 32	(cm 32 x 67 h)	L 9		A4631	1	Ⓒ2
2509	Ø 37	(cm 37 x 75 h)	L 13	A4256		1	Ⓒ2
2518	Ø 47	(cm 47 x 98 h)	L 26	A4239	A4631	1	Ⓒ2



# ilie

---

## gloss

good for **plants**



100%  
Hdpe



kit riserva d'acqua  
water reserve kit



easy for **sales**



rifinito a mano  
hand-finished





kit fissaggio a terra  
ground fixing kit







ilie | vaso • pot light (indoor)

art.	size				
2661	Ø 37 (cm 37 x 75 h)			1	98
2665	Ø 42 (cm 42 x 90 h)			1	98
2669	Ø 47 (cm 47 x 98 h)		A4631	1	98
2673	Ø 57 (cm 57 x 126 h)			1	98

ilie | vaso • pot light (outdoor)

art.	size				
2662	Ø 37 (cm 37 x 75 h)			1	98
2666	Ø 42 (cm 42 x 90 h)			1	98
2670	Ø 47 (cm 47 x 98 h)		A4631	1	98
2674	Ø 57 (cm 57 x 126 h)			1	98

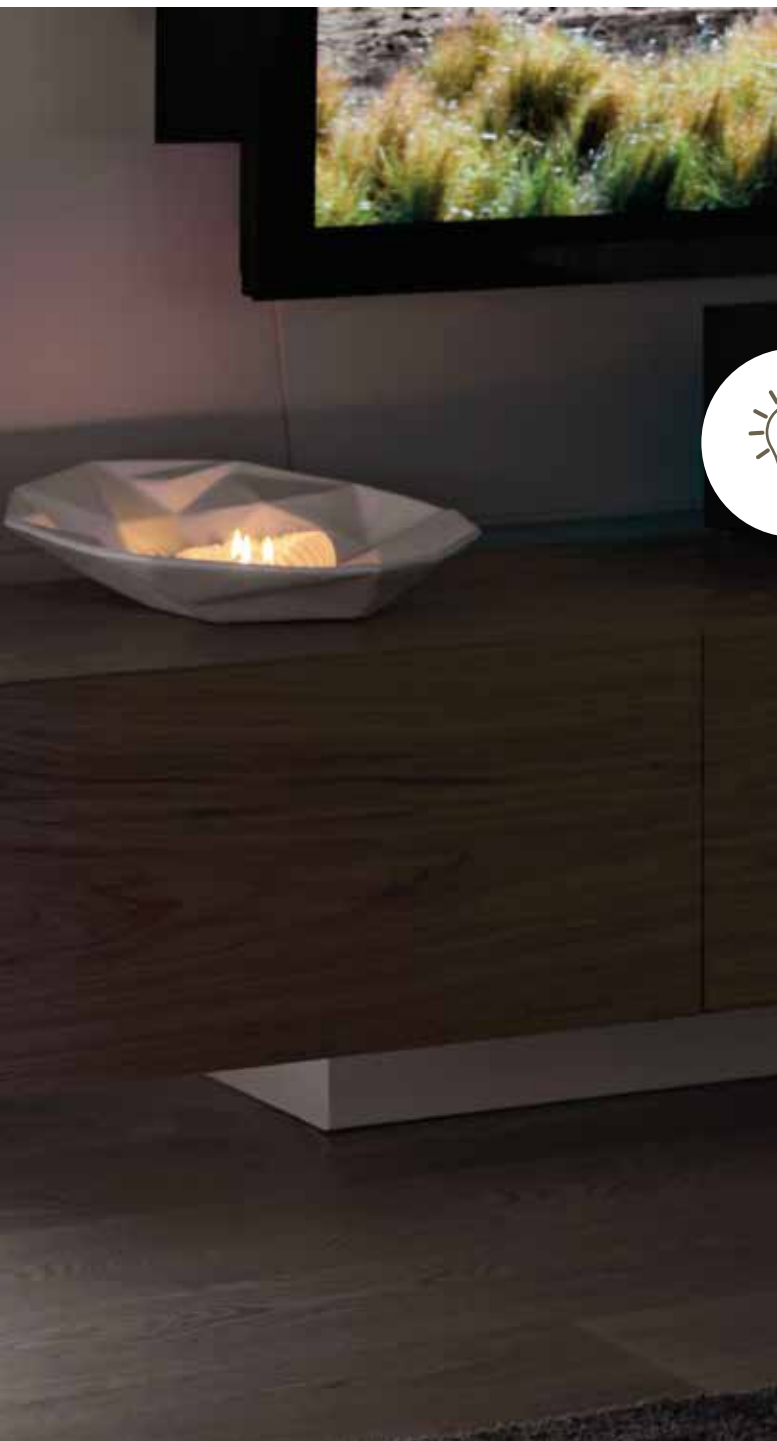

# ilie light

material



lldpe

easy for **sales**



**rifinito a mano**  
hand-finished



**kit fissaggio a terra**  
ground fixing kit











**kit luce montato**  
installed light kit





kiam | vaso quadro • square pot

art.	size				
2499	<b>cm 35</b>	(cm 35 x 35 x 75 h)	L 13	1	  
2500	<b>cm 40</b>	(cm 40 x 40 x 90 h)	L 20	1	  



# kiam

good for plants



lhdpe

easy for sales



rifinito a mano  
hand-finished



kiam gloss | vaso quadro • square pot

art.	size						
2581	<b>cm 30</b>	(cm 30 x 30 x 67 h)	L 9,0	A4255	A4629	1	Ⓢ
2638	<b>cm 35</b>	(cm 35 x 35 x 75 h)	L 14,0	A4373		1	Ⓢ
2582	<b>cm 40</b>	(cm 40 x 40 x 90 h)	L 23,0	A4241	A4629	1	Ⓢ





# kiam

---

## gloss

good for **plants**



lلدpe



kit riserva d'acqua  
water reserve kit

easy for **sales**





rifinito a mano  
hand-finished





kit fissaggio a terra  
ground fixing kit



**kiam** | vaso quadro • square pot light (indoor)

art.	size			
2693	<b>cm 35</b>	(cm 35 x 35 x 75 h)	1	98
2697	<b>cm 40</b>	(cm 40 x 40 x 90 h)	1	98

**kiam** | vaso quadro • square pot light (outdoor)

art.	size			
2694	<b>cm 35</b>	(cm 35 x 35 x 75 h)	1	98
2698	<b>cm 40</b>	(cm 40 x 40 x 90 h)	1	98



# kiam

---

## light

material



lldpe

easy for **sales**



**rifinito a mano**  
hand-finished





**kit luce montato**  
installed light kit





kuno gloss | vaso • pot

art.	size						
2536	Ø 40	(cm 40 x 40 h)	L 14	A4256	A4631	1	Ⓒ2
2534	Ø 50	(cm 50 x 50 h)	L 28	A4239	A4631	1	Ⓒ2
2535	Ø 60	(cm 60 x 60 h)	L 52	A4240	A4631	1	Ⓒ2

# kuno

---

## gloss

good for **plants**



lldpe



kit riserva d'acqua  
water reserve kit



easy for **sales**



rifinito a mano  
hand-finished







kit fissaggio a terra  
ground fixing kit





**quadrum** | vaso quadro • square pot

art.	size						
*2419	cm 37	(cm 37 x 37 x 73 h)	L 16	A4629	1	69	87
*2420	cm 51	(cm 51 x 51 x 100 h)	L 41	A4629	1	69	87

\* per quantitativi minimi • for minimum orders





# quadrum

good for plants



lلدpe



easy for sales





rifinito a mano  
hand-finished



kit fissaggio a terra  
ground fixing kit



akan | cassetta • plant box

art.	size				
*2465	cm 80	(cm 80 x 40 x 33 h)	L 60	1	87 E5

\* per quantitativi minimi • for minimum orders

# akan

good for plants



llDpe



easy for sales



rifinito a mano  
hand-finished



cassetta vaso abbinati  
matching plant box pot



80  
81

akan | vaso quadro • square pot



art.	size				
*2486	cm 40	(cm 40 x 40 x 33 h)	L 25	1	87 E5

\* per quantitativi minimi • for minimum orders





**sfera** | sphere light (outdoor)

art.	size			
2651	Ø 45	(cm 45 x 40 h)	1	98
2716	Ø 55	(cm 55 x 50 h)	1	98
2719	Ø 65	(cm 65 x 60 h)	1	98

# sfera

## light

material



lldpe

easy for sales



rifinito a mano  
hand-finished





kit luce montato  
installed light kit



82  
83

sfera a sospensione | suspended sphere light (indoor/outdoor)

art.	size			
3023	Ø 45 (cm 45 x 40 h)	1	1	98
3024	Ø 55 (cm 55 x 50 h)	1	1	98
3025	Ø 65 (cm 65 x 60 h)	1	1	98



sfera con piedistallo | sphere with pedestal light (outdoor)

art.	size		
2760	Ø 65	(cm 65 x 70 h)	1 





# sfera

---

## light

material



lIdpe

easy for **sales**



**rifinito a mano**  
hand-finished



**kit luce montato**  
installed light kit



**sfera mini** | mini sphere with led light kit (indoor)

art.	size		
2636	Ø 20	(cm 20 x 18 h)	1
			98



# sfera mini

---

## light

material



lldpe

easy for **sales**



**rifinito a mano**  
hand-finished



**kit luce montato**  
installed light kit



# Avvertenze

## Warnings

**1. Tutti i prodotti sono utilizzabili sia negli spazi interni che esterni.**

The entire range of products can be used indoors or outdoors.

**2. Non posizionare l'articolo su una superficie irregolare o inclinata, per evitare movimenti incontrollati.**

Do not position the product on an uneven or sloping surface; this will avoid uncontrolled movements.

**3. Tenere l'articolo lontano da fonti di calore.**

Keep the article away from heat sources.

**4. Gli articoli con pareti dritte realizzati con la tecnica "rotazionale" possono presentare delle non planarità (warpage) che potrebbero accentuarsi qualora il prodotto venisse esposto alla luce diretta del sole.**

Products with straight walls made using the rotational moulding system may show some warping that could become more obvious if the pot is exposed to direct sunlight.

**5. Pulire gli articoli con una spugna bagnata con acqua e detergente liquido neutro. Risciacquare con un panno bagnato. Si raccomanda di evitare l'uso di panni abrasivi e di detersivi contenenti solventi e/o alcool etilico. In caso di sporco ostinato richiedere il detergente Euro3plast.**

Clean the articles with a damp cloth and neutral liquid detergent. Rinse with a clean damp cloth. Do not use abrasive cloths or cleaning agents containing solvents and/or ethyl alcohol. For stubborn stains use the special Euro3plast detergent.

**6. Outdoor**

I vasi prodotti tramite lo stampaggio rotazionale non sono generalmente dotati di fori di drenaggio. Per l'uso esterno, consigliamo di forare sempre i vasi, in modo da favorire la fuoriuscita dell'acqua in eccesso.

Nei vasi a singola parete:

- Praticare dei fori nelle nicchie predisposte sul fondo del vaso.

Nei vasi a doppia parete:

- Praticare dei fori nelle nicchie predisposte sul fondo interno del vaso.
- Togliere il tappo filettato, se presente sul fondo esterno del vaso, avendo cura di verificare che questa apertura sia adeguata, in alternativa praticare altri fori.

Outdoor

Pots produced by means of rotational moulding usually do not have drainage holes. For outdoor use, we always suggest drilling the pots, in order to let excess water leak out.

Single wall pots:

- Drill the holes in the recesses at the bottom of the pot.

Double wall pots:

- Drill the holes in the recesses at the inner bottom of the pot.
- Remove the threaded cap from the outer bottom of the pot (if any), checking carefully that this hole is appropriate. Drill more holes if needed.

---

## LIGHTS

**1. Tutte le lampade presenti in questo catalogo dispongono di un kit luce già installato.**

All the lamps included in this catalogue are supplied with a light kit already installed.

**2. In caso di sostituzione della lampadina, assicurarsi che la presa di corrente sia scollegata.**

Before replacing a bulb make sure that the power plug has been disconnected.

**3. Collegare la spina dell'apparecchio in una presa collocata in un luogo protetto dalla pioggia e dagli spruzzi d'acqua.**

Connect the plug of the appliance to a power outlet that is located in a sheltered position, protected from rain and water splashes.

**4. L'articolo "Sfera a sospensione" che monta il kit a sospensione (A4596), se utilizzato all'esterno, dovrà essere posizionato in luogo coperto.**

If used outdoors, the article "Suspended light sphere" that mounts the suspension kit (A4596) must be installed in a covered context.

**5. Se il cavo flessibile esterno di questo apparecchio viene danneggiato, deve essere sostituito esclusivamente dal costruttore, dal suo servizio di assistenza, o da personale qualificato equivalente, al fine di evitare pericoli.**

If the external flexible cable of this appliance is damaged it must be replaced by either the manufacturer, the manufacturer's customer assistance service or by equivalent qualified personnel, in order to prevent possible hazards.

**6. Nelle versioni sprovviste di interruttore sul cavo di alimentazione, collegare la spina dell'apparecchio sotto una presa comandata da interruttore.**

For models that are not equipped with an inline on/off switch, connect the plug of the appliance to a switch controlled outlet.

**7. Si sconsiglia l'utilizzo e/o l'installazione dei prodotti luminosi su superfici/pavimentazioni non solide (sabbia, terra, erba, sassi, ghiaia, ecc.). Inoltre, i prodotti luminosi non dovranno essere installati in prossimità (adiacenti e sullo stesso piano) di piscine e/o ambienti d'acqua.**

The use and/or installation of illumination devices on instable surfaces/floors or pavement (sand, soil, grass, stones, gravel, etc.) is discouraged. Neither must illumination devices be installed near (adjacent to or on the same level as) swimming pools and/or other water environments.

**8. Gli oggetti luminosi, se allestiti con terra, piante e/o vasi, dovranno essere fissati al suolo con i nostri sistemi di ancoraggio, ove previsti.**

If light articles are set up with soil, plants and/or vases, they must be secured to the ground with our anchoring systems, where provided.

**9. I vasi light outdoor sono dotati di fori di drenaggio all'interno e sul fondo del vaso, oppure di canaletta di scolo. Entrambe le soluzioni servono per favorire la fuoriuscita dell'acqua in eccesso.**

The light outdoor pots have drainage holes inside and on the base, or a drainage tube. Both solutions are to allow excess water to drain away.

**10. Euro3Plast S.p.A. declina ogni responsabilità per danni causati a cose o a persone da un uso improprio del prodotto.**

Euro3Plast S.p.A. cannot accept liability for any damage caused to things or persons by an incorrect use of the product.

# Kit luce

## Light kit

### kit luce LED per **interni** indoor LED light kit

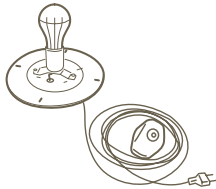

Il kit luce è compatibile con lampadine di classi energetiche E → A++, ed è venduto con una lampada di classe energetica A++.

The light kit is compatible with bulbs of the energy class E → A++, and is sold with a bulb of the energy class A++.

art. A4279

[dettagli • details](#)

**piastra in policarbonato** • polycarbonate plate  
**cavo trasparente** • transparent cable  
**pulsantiera a pedale** • foot switch  
**spina europea bipolare** • european bipolar plug  
**lunghezza cavo** • wire length: **cm 370**

luce • light  
1 x 8,5 W



### kit luce LED per **esterni** outdoor LED light kit

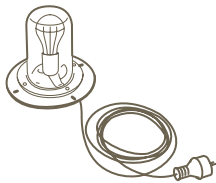

Il kit luce è compatibile con lampadine di classi energetiche E → A++, ed è venduto con una lampada di classe energetica A++.

The light kit is compatible with bulbs of the energy class E → A++, and is sold with a bulb of the energy class A++.

art. A4280

[dettagli • details](#)

**piastra in policarbonato** • polycarbonate plate  
**guscio in policarbonato** • polycarbonate shell  
**guarnizione a tenuta** • gasket seal  
**cavo nero** • black cable  
**spina schuko antispruzzo** • anti-splash  
**lunghezza cavo** • wire length: **cm 280**

luce • light  
1 x 8,5 W



### kit luce LED RGB E27 per **interni** indoor RGB E27 LED light kit



Il kit luce è compatibile con lampadine di classi energetiche E → A++, ed è venduto con una lampada di classe energetica A.

The light kit is compatible with bulbs of the energy class E → A++, and is sold with a bulb of the energy class A.

art. A4719

[dettagli • details](#)

**piastra in policarbonato** • polycarbonate plate  
**cavo trasparente** • transparent cable  
**pulsantiera a pedale** • foot switch  
**spina europea bipolare** • european bipolar plug  
**lunghezza cavo** • wire length: **cm 370**

luce • light  
1 x 11,5 W





## kit luce LED RGB E27 per **esterni** **outdoor** RGB E27 LED light kit



Il kit luce è compatibile con lampadine di classi energetiche E → A++, ed è venduto con una lampada di classe energetica A.

The light kit is compatible with bulbs of the energy class E → A++, and is sold with a bulb of the energy class A.

art. A4720

dettagli • details

**piastra in policarbonato** • polycarbonate plate  
**guscio in policarbonato** • polycarbonate shell  
**guarnizione a tenuta** • gasket seal  
**cavo nero** • black cable  
**spina schuko antispruzzo** • anti-splash  
**lunghezza cavo** • wire length: **cm 280**

luce • light  
1 x 11,5 W



## kit luce LED RGB E27 con telecomando per **interni** **indoor** RGB E27 LED light kit with remote control

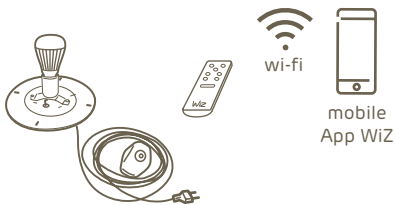

Il kit luce è compatibile con lampadine di classi energetiche E → A++, ed è venduto con una lampada di classe energetica A.

The light kit is compatible with bulbs of the energy class E → A++, and is sold with a bulb of the energy class A.

art. A4710

dettagli • details

**piastra in policarbonato** • polycarbonate plate  
**telecomando** • remote control  
**cavo trasparente** • transparent cable  
**pulsantiera a pedale** • foot switch  
**spina europea bipolare** • european bipolar plug  
**lunghezza cavo** • wire length: **cm 370**

luce • light  
1 x 11,5 W



90  
91

## kit luce LED RGB E27 con telecomando per **esterni** **outdoor** RGB E27 LED light kit with remote control



Il kit luce è compatibile con lampadine di classi energetiche E → A++, ed è venduto con una lampada di classe energetica A.

The light kit is compatible with bulbs of the energy class E → A++, and is sold with a bulb of the energy class A.

art. A4711

dettagli • details

**piastra in policarbonato** • polycarbonate plate  
**guscio in policarbonato** • polycarbonate shell  
**telecomando** • remote control  
**guarnizione a tenuta** • gasket seal  
**cavo nero** • black cable  
**spina schuko antispruzzo** • anti-splash  
**lunghezza cavo** • wire length: **cm 280**

luce • light  
1 x 11,5 W



## kit mini led light per **interni** mini led light kit **indoor**

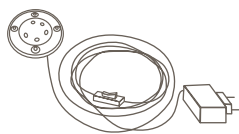

Il kit luce è munito di lampade a LED integrate con classe energetica A → A++.

The light kit is equipped with integrated LED bulbs of the energy class A → A++.

art. A4303

dettagli • details

cavo trasparente • transparent cable  
spina europea bipolare • european bipolar plug  
trasformatore in 12V a parete • 12V wall transformer  
pulsantiera • switch  
lunghezza cavo • wire length: **cm 140**

luce • light  
modulo 6 led bianchi 1,5 W  
1,5 W white 6 led module



---

## kit luce a sospensione per **interni/esterni** **indoor/outdoor** light kit to suspension



Il kit luce è compatibile con lampadine di classi energetiche E → A++, ed è venduto con una lampada di classe energetica A.

The light kit is compatible with bulbs of the energy class E → A++, and is sold with a bulb of the energy class A.

art. A4596

dettagli • details

piastra in policarbonato • polycarbonate plate  
guscio in policarbonato • polycarbonate shell  
guarnizione a tenuta • gasket seal  
cavo nero • black cable  
lunghezza cavo • wire length: **cm 200**  
fili in acciaio per la sospensine • steel wires for suspension  
staffa metallica di fissaggio a soffitto • metal bracket for ceiling mount  
rosone metallico • metal ceiling rose  
kit luce regolabile in altezza • light kit adjustable in height

luce • light  
1 x 20 W



E27

CL. I



# Legenda/Legend



Lampadina a LED MAX 1 x 11,5 W  
LED bulb MAX 1 x 11,5 W



Lampada fluorescente MAX 1 x 60 W  
Fluorescent lamp MAX 1 x 60 W

## CL. I

Classe di isolamento: Classe I.

Apparecchio protetto alla scossa elettrica tramite isolamento principale e provvisto di un dispositivo per la messa a terra.

Protection class: Class I

Apparatus protected against electric shock through main insulation, and provided with grounding device.



Classe di isolamento: Classe II.

Con doppio isolamento e/o rinforzo in ogni parte e senza dispositivi per la messa a terra.

Insulation class: Class II.

With double insulation and/or reinforcement in each part and without ground devices.



Classe di isolamento: Classe III

Con isolamento ridotto perchè destinato a essere esclusivamente alimentato da un sistema a bassissima tensione di sicurezza (minore o uguale a 48V dc) e nel quale si generano tensioni di valore superiore a quello di tale sistema.

Insulation class: Class III.

With reduced insulation because the device is destined to be powered exclusively by a safety extra-low voltage system (max. 48V DC or less) in which voltages of values higher than those of such system are generated.



Attesta la conformità del prodotto alle disposizioni delle direttive comunitarie.

It certifies the conformity of the product to the European community instructions.

IP 20

Prodotto di uso ordinario. Protetto contro corpi solidi di diametro superiore a 12,5mm. L'utente non ha comunque modo di entrare in contatto con le parti in tensione. Prodotto con nessuna protezione nei confronti della penetrazione dell'acqua.

Product for ordinary use, protected against solid objects larger than 12.5 mm in diameter. Users cannot however come into contact with the live parts. This product has no water protection.

IP 44

Protetto contro corpi solidi di diametro superiore ad 1 mm. Prodotto resistente agli spruzzi d'acqua.

Protected against solid bodies with a diameter over 1 mm. Splash-resistant product.

IP 67

Totamente protetto contro la penetrazione di polveri. Prodotto resistente all'immersione temporanea massimo ad 1m di profondità. L'icona, dove presente, fa riferimento al corpo lampada.

Totally protected against penetration of dust. Product resistant against temporary immersion in water to a maximum of 1 m depth. Wherever present, the icon refers to the lamp's casing.

IP 68

Totamente protetto contro la penetrazione di polveri. Prodotto resistente alla sommersione permanente in acqua. L'icona, dove presente, fa riferimento al corpo lampada.

Totally protected against penetration of dust. Product resistant against permanent immersion in water. Wherever present, the icon refers to the lamp's casing.



Ai sensi della Direttiva 2012/19/UE, il prodotto, alla fine della sua vita utile, non deve essere smaltito come rifiuto urbano.

According to the Directive 2012/19/UE, once the device life time is ended, it must not be disposed as urban waste.

Tutte le apparecchiature elettriche sono conformi alle direttive 2011/65/UE sulle Restrizioni d'uso di alcune sostanze pericolose (RoHS), recepite in Italia con il D.lgs 04/03/2014 n.27.

All electric equipments meet the Directives 2011/65/UE about the Reduction of the use of certain Hazardous Substances (RoHS), which came into force in Italy with D. lgs 04/03/2014 n.27.

### Avvertenze - Warning:

- Tutte le lampade presenti in questo catalogo dispongono di un kit luce già installato.
- In caso di sostituzione della lampadina, assicurarsi che la presa di corrente sia scollegata.
- Collegare la spina dell'apparecchio in una presa collocata in un luogo protetto dalla pioggia e dagli spruzzi d'acqua.
- L'articolo "Sfera a sospensione" che monta il kit a sospensione (A4596), se utilizzato all'esterno, dovrà essere posizionato in luogo coperto.
- Se il cavo flessibile esterno di questo apparecchio viene danneggiato, deve essere sostituito esclusivamente dal costruttore, dal suo servizio di assistenza, o da personale qualificato equivalente, al fine di evitare pericoli.
- Nelle versioni sprovviste di interruttore sul cavo di alimentazione, collegare la spina dell'apparecchio sotto una presa comandata da interruttore.
- Si sconsiglia l'utilizzo e/o l'installazione dei prodotti luminosi su superfici/pavimentazioni non solide (sabbia, terra, erba, sassi, ghiaia, ecc.). Inoltre, i prodotti luminosi non dovranno essere installati in prossimità (adiacenti e sullo stesso piano) di piscine e/o ambienti d'acqua.
- Gli oggetti luminosi, se allestiti con terra, piante e/o vasi, dovranno essere fissati al suolo con i nostri sistemi di ancoraggio, ove previsti.
- I vasi light outdoor sono dotati di fori di drenaggio all'interno e sul fondo del vaso, oppure di canaletta di scolo. Entrambe le soluzioni servono per favorire la fuoriuscita dell'acqua in eccesso.
- Euro3Plast S.p.A. declina ogni responsabilità per danni causati a cose o a persone da un uso improprio del prodotto.

- All the lamps included in this catalogue are supplied with a light kit already installed.
- Before replacing a bulb make sure that the power plug has been disconnected.
- Connect the plug of the appliance to a power outlet that is located in a sheltered position, protected from rain and water splashes.
- If used outdoors, the article "Suspended light sphere" that mounts the suspension kit (A4596) must be installed in a covered context.
- If the external flexible cable of this appliance is damaged it must be replaced by either the manufacturer, the manufacturer's customer assistance service or by equivalent qualified personnel, in order to prevent possible hazards.
- For models that are not equipped with an inline on/off switch, connect the plug of the appliance to a switch controlled outlet.
- The use and/or installation of illumination devices on instable surfaces/floors or pavement (sand, soil, grass, stones, gravel, etc.) is discouraged.
- Neither must illumination devices be installed near (adjacent to or on the same level as) swimming pools and/or other water environments.
- If light articles are set up with earth, plants and/or vases, they must be secured to the ground with our anchoring systems, where provided.
- The light outdoor pots have drainage holes inside and on the base, or a drainage tube. Both solutions are to allow excess water to drain away.
- Euro3Plast S.p.A. cannot accept liability for any damage caused to things or persons by an incorrect use of the product.



## indice generale general index

art.	pag.
<b>a:</b>	
<b>akan</b> (cassetta • plant box)	p. 80
<b>akan</b> (vaso quadro • square pot)	p. 81
<b>e:</b>	
<b>etria</b> (vaso con doppia parete • pot with double wall)	p. 62
<b>etria uno</b> (vaso con singola parete • pot with single wall)	p. 63
<b>i:</b>	
<b>ikon</b> (s/vaso • saucer)	p. 57
<b>ikon</b> (vaso • pot)	p. 56
<b>ikon</b> (vaso con fori • pot with holes)	p. 60
<b>ikon</b> (vaso con fori chiuso sopra • pot with holes closed on top)	p. 61
<b>ilie</b> (vaso • pot)	p. 64
<b>ilie gloss</b> (vaso • pot)	p. 66
<b>ilie</b> (vaso light • light pot)	p. 68
<b>k:</b>	
<b>kiam</b> (vaso quadro • square pot)	p. 70
<b>kiam gloss</b> (vaso quadro • square pot)	p. 72
<b>kiam</b> (vaso quadro light • square light pot)	p. 74
<b>kube</b> (cassetta • plant box)	p. 22
<b>kube</b> (cassetta con ruote • plant box with castors)	p. 22
<b>kube</b> (panca • bench)	p. 50
<b>kube</b> (panca light • light bench)	p. 52
<b>kube</b> (sgabello • stool)	p. 51
<b>kube</b> (sgabello light • light stool)	p. 53
<b>kube</b> (vaso • pot)	p. 23
<b>kube</b> (vaso con ruote • pot with castors)	p. 23
<b>kube gloss</b> (vaso • pot)	p. 26
<b>kube high</b> (cassetta alta • high plant box)	p. 32
<b>kube high</b> (cassetta alta con ruote • high plant box with castors)	p. 32
<b>kube high</b> (cassetta alta light • high light plant box)	p. 38
<b>kube high</b> (vaso alto • high pot)	p. 33
<b>kube high</b> (vaso alto con ruote • high pot with castors)	p. 33
<b>kube high</b> (vaso alto light • high light pot)	p. 39
<b>kube high slim</b> (cassetta alta • high plant box)	p. 40
<b>kube high slim</b> (cassetta alta light • high light plant box)	p. 44
<b>kube high slim</b> (vaso alto • high pot)	p. 41
<b>kube high slim</b> (vaso alto light • high light pot)	p. 45

---

art.

pag.

---

**k:**

<b>kube mini</b> (cassetta • plant box)	p.	28
<b>kube mini</b> (cassetta light • light plant box)	p.	30
<b>kube mini</b> (cubo light • light cube)	p.	54
<b>kube mini</b> (vaso • pot)	p.	29
<b>kube mini</b> (vaso light • light pot)	p.	31
<b>kube tower</b> (cassetta alta • high plant box)	p.	46
<b>kube tower</b> (cassetta alta light • high light plant box)	p.	48
<b>kube tower</b> (vaso alto • high pot)	p.	47
<b>kube tower</b> (vaso alto light • high light pot)	p.	49
<b>kuno gloss</b> (vaso • pot)	p.	76

---

**q:**

<b>quadrum</b> (vaso quadro • square pot)	p.	78
---	----	----

---

**s:**

<b>sfera</b> (light sphere)	p.	82
<b>sfera a sospensione</b> (suspended light sphere)	p.	83
<b>sfera con piedistallo</b> (light sphere with pedestal)	p.	84
<b>sfera mini</b> (mini light sphere)	p.	86

ATTENZIONE: La stampa su carta non sempre riproduce fedelmente i colori dei prodotti.

Le immagini e i dati riportati in questo catalogo sono indicativi. **Euro3plast spa** si riserva il diritto di apportare eventuali variazioni o migliorie agli articoli illustrati, anche senza preavviso. I nostri uffici commerciali rimangono a vostra completa disposizione per qualsiasi ulteriore delucidazione.

Tutto il materiale contenuto in questo catalogo, compresi i testi, le fotografie, i disegni, è proprietà di **euro3plast spa** e pertanto è protetto dalle leggi che tutelano la proprietà intellettuale. Per tale motivo non può essere utilizzato senza esplicita autorizzazione scritta da **euro3plast spa**.

ATTENTION: The print on the paper doesn't grant the accurate reproduction of the colors.

The images and the indicated data in our catalogue are approximate. **Euro3plast spa** reserves the right to effect any changes or improvements, to the illustrated articles, also without notice. For further information, our Customer Service are at your disposal.

All the material in this catalogue (including texts, photos and drawing), belong to **euro3plast spa**. Therefore it is protected by laws defending intellectual property. For this reason it cannot be used by anybody without the prior and written authorization of **euro3plast spa**.





02/2022

**euro3plast spa**

viale del lavoro, 45  
36048 ponte di barbarano (vi) • italy

t +39 0444 788200  
f +39 0444 788290

[www.euro3plast.com](http://www.euro3plast.com)  
[info@euro3plast.com](mailto:info@euro3plast.com)