

Una storia di successi dal 1988
A story of successes since 1988

ARKEMA®
DESIGN

MADE IN ITALY

Sostenibili per natura
Sustainable by nature



ARKEMA DESIGN®, brand del gruppo Cornaglia, è da sempre legata al mondo della produzione nei vari settori: dall'arredamento, all'automotive, con l'obiettivo di essere sempre all'avanguardia per tecnologie - design - servizio al cliente - e costi competitivi.

Jean Rusconi ha progettato e disegnato tutti i nostri prodotti, attento alle esigenze del mercato, già nel 1988 ha presentato quella che è conosciuta come la prima doccia a riscaldamento solare sul Mercato.

Negli ultimi dieci anni abbiamo rilanciato questo progetto, con vasto incremento della gamma.

Pensato per tutte le esigenze grazie al design, alla qualità e al prezzo corretto, ha avuto da subito un grande successo e una crescita esponenziale nelle vendite. Crediamo molto in questo accessorio utile a tutti e abbiamo fatto importanti investimenti sulla produzione e sui modelli, che ci consentono di affrontare preparati la richiesta del mercato.

Riteniamo che, non essendo ancora conosciuto dal grande pubblico, la sua costante crescita e divulgazione sarà naturale: così come confermato dai dati di questi ultimi anni. Molti sono gli innovativi progetti in cantiere dedicati alle docce, delle quali vantiamo già alcune copie, allargando la gamma agli arredi e al garden. Siamo inoltre in grado di offrire la realizzazione di prodotti personalizzati con marchio dedicato.

ARKEMA DESIGN®, la più vasta gamma di docce solari/tradizionali, realizzata nei nostri stabilimenti di Villanova d'Asti (Torino), con tecnologie d'avanguardia, un riferimento produttivo per ottimizzare il vostro business.

Nel 2021, la casa madre Cornaglia Group, per favorirne l'ulteriore sviluppo, ha deciso di trasferire il brand ARKEMA DESIGN® ad una divisione dedicata: PLART DESIGN S.R.L.



ARKEMA DESIGN®, a brand of the Cornaglia group, has always been linked to the world of production in various sectors: from furnishing to automotive with the aim of always being up to date for technologies-design-customer service and competitive costs.

Jean Rusconi designed and drawn all of our products. Focused on the needs of the Market, already in 1988 he introduced the shower that nowadays is known as the first Solar Heated Shower on the Market.

During these last ten years, we re-launched this project, with a great expansion in the range of products.

Thought for all needs, thanks to the design, to the quality and correct price, it has had from the beginning great success with an exponential growth in sales.

We strongly believe in this useful accessory for everyone. We have made important investments in the production and on the models, this prepares us ready to face the requests of the market.

We think that, as the product is not yet known to the majority of people, its constant growth and diffusion will be natural, confirmed by the data of the last years. Many innovative projects dedicated to the showers of which we already boast some copies are under development, enlarging the range to furnishing and garden. In addition, we are able to offer the production of personalized products with dedicated branding.

ARKEMA DESIGN®, the greatest range of solar/traditional showers made in our Plants in Villanova d'Asti (Turin - Italy) with forefront technologies; a production reference to optimize your business.

In 2021, in order to encourage further development, the mother company Cornaglia Group decided to transfer ARKEMA DESIGN® brand to a dedicated, specific division: PLART DESIGN S.R.L.



ARKEMA DESIGN®, brand du groupe Cornaglia est depuis toujours lié au monde de la production dans plusieurs secteurs : de l'ameublement à l'automotive, avec l'objectif d'être toujours à l'avant-garde pour les technologies- design-service au client- et coûts compétitifs.

Jean Rusconi, sensible aux exigences du Marché, a projeté et dessiné tous nos produits déjà en 1988.

Il a introduit celle qui est connue comme la première douche à chauffage solaire sur le Marché.

Pendant les dernières années nous avons relancé ce projet, avec un grand incrément de la gamme.

Pensé pour tous les exigences, grâce au design, à la qualité et au prix correct qui a eu immédiatement un grand succès et une croissance exponentielle des ventes.

Nous croyons beaucoup dans cet accessoire utile à tous, nous avons fait des importants investissements sur la production et sur les modèles, qui nous permettent de faire face préparés à la demande du Marché.

Nous retenons que, n'étant pas connu par la plupart du public, sa constante croissance et divulgation sera naturelle, confirmé des données de ces dernières années. Les projets innovants dédiés aux douches en préparation sont beaucoup, des quels nous ventons déjà quelques copies, en augmentant la gamme aux ameublements et aux jardins. Nous sommes en plus, en mesure d'offrir la réalisation des produits personnalisés, avec marque dédié.

ARKEMA DESIGN®, la plus vaste gamme de douches solaires/traditionnelles prête à livrer, réalisé dans nos usines à Villanova d'Asti (Turin- Italie), avec technologie d'avant-garde, un référence productif pour optimiser votre business. En 2021, la maison mère Cornaglia Group, pour encourager son développement, a décidé de transférer la marque ARKEMA DESIGN® vers une division dédiée: PLART DESIGN S.R.L.



ARKEMA DESIGN®, marca del grupo Cornaglia, siempre ha estado vinculado al mundo de la producción en los diversos sectores: desde el mobiliario hasta la automoción, con el objetivo de estar siempre a la vanguardia de las tecnologías: diseño, servicio al cliente y costos competitivos.

Jean Rusconi ha concebido y diseñado todos nuestros productos, atento a las necesidades del mercado, ya en 1988 presentó lo que se conoce como la primera ducha calentada con energía solar en el mercado.

En los últimos diez años hemos relanzado este proyecto, con un gran aumento en el rango.

Diseñado para todas las necesidades, gracias al diseño, la calidad y el precio correcto, ha tenido un gran éxito de inmediato y un crecimiento exponencial en las ventas.

Creemos mucho en este accesorio útil para todos, hemos hecho grandes inversiones en producción y modelos, que nos permiten enfrentarnos a la demanda del mercado.

Creemos que, dado que aún no es conocido por el público en general, su crecimiento y difusión constantes serán naturales, según confirman los datos de los últimos años. Hay muchos proyectos innovadores en la tubería dedicada a las duchas, de los cuales ya tenemos algunas copias, ampliando la gama de muebles y el jardín. También podemos ofrecer la creación de productos personalizados, con marca dedicada.

ARKEMA DESIGN®, la gama más amplia de duchas solares/tradicionales listas para su entrega, hechas en nuestras plantas de Villanova d'Asti (Turin - Italia), con tecnologías de vanguardia; una referencia productiva para optimizar su negocio.

En 2021, la empresa matriz Cornaglia Group, para fomentar un mayor desarrollo, decidió transferir la marca ARKEMA DESIGN® a una división dedicada: PLART DESIGN S.R.L.

UN MILIARDO DI GIARDINI NEL MONDO ASPETTANO LA DOCCIA SOLARE



1988
"Scultura"
la prima doccia
solare



2008
"Dada", "Spring",
"Jolly"
la linea si amplia



2010
"Happy"
la doccia più
copiata

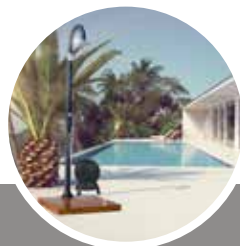

2020
"Funny", "HotBall"
l'evoluzione della
specie



2023
"Quick", "EggBall"
tutti ovunque
per un grande
business

Arkema Design®, leader mondiale nelle docce a riscaldamento solare, integrata nella Cornaglia Group SPA, con la sua ampia gamma di prodotti, soddisfa tutte le esigenze del mercato.

Attenta all'evoluzione dei prodotti, dopo aver esaminato le osservazioni dei vari interlocutori, sono emerse le seguenti esigenze: realizzare un prodotto di rapida vendita e consegna, riducendo sensibilmente tutti i costi e ritardi dovuti allo stoccaggio, oltre a ridurre il costo di trasporto e le varie criticità annesse.

Un prodotto da banco per una consegna immediata e un prodotto senza problemi, con bassi costi di trasporto per la vendita on line; un'ampia possibilità di business.

In vista delle esigenze dettate dal mercato, abbiamo realizzato la linea QUICK: una doccia indiscutibile e comprensibile anche dai meno esperti, che grazie all' HOT BALL e WARM EGG si trasforma in doccia a riscaldamento solare, senza limitazioni di colore, con posizionamento anche all'interno.

CARATTERISTICHE PRINCIPALI:

- Smontabile, non richiede capacità di assemblaggio.
- Pallettizzabile nella dimensione dei pallet universali 80 x120 riducendo drasticamente i costi di trasporto (sia per quantità che per vendita in drop shipping).
- QUICK usata singolarmente è una doccia tradizionale, abbinata ai nostri collettori solari HOT BALL -WARM EGG, diventa una doccia a riscaldamento solare molto funzionale.
- La gamma di colori e il design rendono QUICK facilmente ambientabile nelle più svariate situazioni, compreso il settore nautico, poiché consente un rapido rimessaggio.
- Finiture eleganti e sofisticate- particolarmente interessanti nella versione - marmo- carbonio-inox lucido, oltre ai colori di tendenza.
- Versione con illuminazione per ambientazioni scenografiche anche di notte e per cabine.

Questa tecnologia permette la riduzione del consumo di acqua e energia.

Realizzata con materiali riciclabili, entra a pieno titolo in tutte le nuove strategie di riduzione dell'inquinamento e relativi sgravi fiscali.

A BILLION GARDENS IN THE WORLD ARE WAITING FOR THE SOLAR SHOWER



1988
"Scultura"
the first solar
shower



2008
"Dada", "Spring",
"Jolly"
the line expands



2010
"Happy"
the most copied

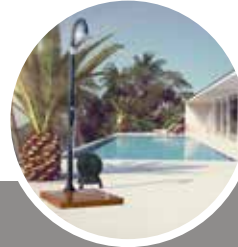

2020
"Funny", "HotBall"
the beginning of
evolution



2023
"Quick", "EggBall"
everyone,
everywhere for
big business

Arkema Design®, world leader in solar heated showers®, integrated in Cornaglia Group SPA with its wide range of products to meet all the requirements of the market.

Paying attention to the evolution of the products, after examining the observations of the various stakeholders, the following requirements emerged to create a product for quick sale and delivery significantly reducing all costs and delays due to storage, as well as reducing the cost of transport and the various related criticalities.

An over-the-counter product for immediate delivery and hassle-free, low transport costs for online sales, creating a wide business opportunity.

In light of the demands dictated by the market, we created the QUICK line, an unquestionable and understandable shower even for the less experienced, which thanks to the HOT BALL and WARM EGG can be transformed into a solar heated shower, with no colour restrictions (and can also be positioned indoors).

MAIN FEATURES:

- Divisible, requires no assembly skills.
- Palletisable in the size of 80 x120 universal pallets, drastically reducing transport space (both in terms of quantity and drop shipping).
- QUICK used individually is a traditional shower, which combined with our solar collectors HOT BALL -WARM EGG, becomes a very functional solar-heated shower. .
- The range of colours and design make QUICK easily adaptable to the most diverse situations, including the nautical sector, as it allows rapid storage.
- Elegant and sophisticated finishes - particularly interesting in the marble- carbon-polished stainless steel, as well as trendy colours.
- Version with lighting for scenic settings and cabins.

This technology allows the reduction of water and energy consumption.

Made from recyclable materials, it is fully compliant with all nine pollution reduction strategies and related tax breaks.

JEAN RUSCONI



Jean Rusconi nasce a Torino, città Capitale del design e delle tecnologie innovative.

Da sempre si occupa di produzione industriale legata al design, della funzione e l'innovazione, principalmente nei settori della nautica e dell'arredamento. Ha realizzato prodotti funzionali con l'obiettivo di migliorare la qualità della vita riducendo al minimo gli sprechi e incentivando una maggiore sostenibilità ambientale.

Rusconi è tra i precursori del rotazionale nel settore dell'arredamento, nel 1988 realizza "SCULTURA" la prima doccia a riscaldamento solare in seguito prodotta industrialmente, diventando un'icona per molti anni.

Successivamente, seguendo la grande evoluzione nel mondo della piscina e del giardino nascono le docce Dada, Jolly e Happy, senza dimenticare Serendipity, la chaise lounge per il relax; questi prodotti grazie alla funzionalità e al design accattivante hanno creato un mercato prima inesistente.

Oggi per affrontare le nuove sfide energetiche e ambientali, con pragmatica attenzione alla soluzione delle nuove esigenze del mercato, nascono HOT BALL e QUICK per rendere ancora più funzionali gli spazi esterni e offrire al cliente una gamma completa.



Jean Rusconi was born in Turin, the capital of design and innovative technologies.

He has forever been involved in industrial production linked to the design of function and innovation, mainly in the nautical and furnishing sectors. He created functional products that improve the quality of life by minimising waste and encouraging greater environmental sustainability.

Rusconi is among the forerunners of rotational moulding in the furniture industry. In 1988 he produced the first solar-heated shower "SCULTURA", which was later industrially produced and became an icon for many years.

From that first step following the great evolution in the pool and garden world came the Dada, Jolly and Happy showers, not forgetting the Serendipity, chaise lounge for relaxation which thanks to its functionality and attractive design created a market that did not exist before.

Today, to face the new energy and environmental challenges, with a pragmatic attention to the solution of new market needs, HOT BALL and QUICK are born to make outdoor spaces even more functional and to offer customers a complete range.



CORNAGLIA GROUP A SOSTEGNO DEL PIANETA



ECONOMIA CIRCOLARE

Per recuperare la materia prima seconda dai prodotti di scarto la Cornaglia S.p.A ha acquistato un macinatore. La materia prima seconda viene poi inviata al centro ricerche che lo analizza e ne indica i migliori utilizzi.

CIRCULAR ECONOMY

In order to recover secondary raw material from waste products, Cornaglia S.p.A. has purchased a grinder. The secondary raw material is then sent to the research centre, which analyses it and indicates the best uses for it.



RISPARMIO ENERGETICO

I 5 impianti fotovoltaici installati sui tetti degli stabilimenti producono annualmente circa 4 milioni di kWh di energia pulita evitando l'emissione di 1.600 tonnellate di CO2 ogni anno. Ulteriori aree di intervento interessano il recupero del vapore flash, l'introduzione di scambiatori di calore, la riconversione dei generatori, l'inserimento di compressori con inverter, la conversione ed illuminazione Led e la depurazione delle acque reflue.

ENERGY SAVING

The 5 photovoltaic systems installed on the roofs of the factories produce around 4 million kWh of clean energy annually, avoiding emissions of 1,600 tons of CO2 each year. Other areas of intervention concern the recovery of up to flash steam, the introduction of heat exchangers, the conversion of generators, the insertion of compressors with inverters, installation of LED lighting and purification of waste water.



RICERCA E SVILUPPO

Il Centro Ricerche riconosciuto dal Ministero dell'Istruzione dell'Università e della Ricerca, è una struttura moderna situata a Grugliasco. Vi lavorano circa 50 persone altamente specializzate, impiegate nella ricerca e nello sviluppo, nella realizzazione di prototipi e nella verifica sperimentale.

RESEARCH AND DEVELOPMENT

R&D Centre, recognised by the Ministry of Education, of the University and Research, is a modern facility located in Grugliasco. It employs around 50 highly specialised people in research and development, prototyping and experimental testing.

TECNOLOGIA



TECNOLOGIA/TECHNOLOGY:

- Taglio laser/Lasercut
- Pellicola/Wrapping
- Stampaggio alluminio/Aluminum moulding
- Soffiaggio tradizionale/ Traditional blowing
- Lavorazione e taglio ecologico di MDF/ Ecological MDF processing and cutting
- Stampaggio a iniezione/Injection moulding
- Stampaggio rotazionale/Rotational moulding
- Termoformatura/Thermoforming

OUR SERVICES



YOUR IDEA
PROJECT FEASIBILITY



WE STUDY
YOU ALL DETAILS



WE DEFINE WITH
YOUR SUCCESS



OUR SUPPORT
FOR THE PROJECT



WE START UP FOR YOU



WE PRODUCE



AVETE UN' IDEA MA NON SAPETE COME REALIZZARLA?

Noi siamo la soluzione. Con il nostro supporto viene esaminata la fattibilità del progetto. Tutti i dettagli vengono analizzati con cura con voi, per un risultato ottimale.

Possiamo realizzare ogni vostro progetto grazie alle molteplici tecnologie che possediamo.

- PROTOTIPAZIONE
- REALIZZAZIONE STAMPI
- SPECIALI TECNOLOGIE PER LA CURVATURA DEI PROFILI
- STAMPAGGIO TECNOLOGIA ROTOMOULDING, INIEZIONE E SOFFIAGGIO
- FONDERIA ALLUMINIO
- STAMPAGGIO METALLO A CALDO
- TORNITURA
- TRANSFER ROBOTIZZATO
- VERNICIATURA A POLVERE E A LIQUIDO

Tutti gli articoli presenti su questo listino possono essere realizzati con delle varianti su richiesta del Cliente da concordare con il nostro ufficio commerciale, su quantitativo minimo d'ordine.



YOU HAVE AN IDEA BUT DON'T KNOW HOW TO PUT IT TOGETHER?

We are the solution. With our support, the feasibility of the project is examined. All the details are analyzed with care together, for an optimal result.

We can create your project thanks to the multiple technologies that we have.

- PROTOTYPING
- MOLD MANUFACTURING
- SPECIAL TECHNOLOGIES FOR PROFILES BENDING
- ROTOMOULDING TECHNOLOGY, BLOW MOLDING AND INJECTION
- ALUMINUM FOUNDRY
- FORGING
- LATHING
- ROBOT TRANSFER
- POWDER AND LIQUID COATING

All the articles present on this price list can be made with variants on Customer request to be agree with our commercial office on minimum order quantity.



VOUS AVEZ UNE IDÉE, MAIS VOUS NE SAVEZ PAS COMMENT LA RÉALISER?

Nous sommes la solution. Avec notre soutien, on examine la faisabilité du projet et on analyse tout avec soin avec vous, pour avoir un résultat optimal.

Nous pouvons réaliser votre projet grâce aux multiples technologies que nous avons à disposition.

- PROTOTYPAGE
- RÉALISATION DE MOULES
- TECHNOLOGIES SPÉCIALES CINTRAGE DES PROFILES EN ALUMINIUM
- ROTOMOULAGE, INJECTION ET SOUFFLAGE
- FONDERIE D'ALUMINIUM
- IMPRESSION À CHAUD DE MÉTAUX
- CHARIOTAGE
- TRANSFERT ROBOTISÉ
- PEINTURE EN POUDRE ET LIQUIDE

Tous les articles de cette liste de prix peuvent être fabriqués avec des variantes à la demande du Client accepté du côté de notre bureau commercial, sur la quantité minimale de commande.



TIENES UNA IDEA, ¿PERO NO SABES ÓMO REALIZARLA?

Somos la solución. Con nuestro apoyo, examinamos la facilitación del proyecto. Todos los detalles se detenedamente con usted, para un resultado óptimo.

Podemos realizar su proyecto gracias a las múltiples tecnologías que tenemos.

- CREACION DE PROTOTIPOS
- PRODUCCION DE MOLDES
- TECNOLOGÍAS ESPECIALES PARA CURAVTURA DE PERFILES
- TECNOLOGIA DE MOLDES ROTACIONAL, SOPLADORAS Y INYECTORAS
- FUNDICION DE ALUMINIO
- IMPRESION DE METALES EN CALIENTE
- TORNERIA
- TRANSFERENCIA ROBOTIZADA
- PINTURA EN POLVO Y EN LIQUIDA

Todos los artículos en esta lista de precios se puedan hacer con variantes a petición del cliente a convenir con nuestra oficina comercial, sobre el pedido mínimo.

SUSTAINABLE CIRCULAR ECONOMY PROJECT



Il progetto ricicli-AMO® ha la finalità di favorire con processi e atti concreti una netta sensibilizzazione rispetto ai processi di economia circolare. Ci poniamo l'obiettivo di coinvolgere sempre più la comunità imprenditoriale, divulgando i temi legati alla sostenibilità ambientale, economica e sociale, nella certezza che "la genialità" che nasce dall'incontro e dalla condivisione, possa gettare le basi per creare nuovi modelli di vita e di consumo.

Dal 2020 Plart Design ha deciso di utilizzare per i suoi processi produttivi materiale riciclabile o riciclato. A tal proposito un importante accordo è stato siglato con L'Oréal Saipo Industriale per rigenerare materiali plastici utilizzati, al fine di dare una seconda vita alla plastica producendo nuovi mezzi di raccolta da reintrodurre nello stabilimento.



The ricicli-AMO® project has the purpose of favoring net results with concrete procedures and acts, raising awareness of circular economy processes. We set ourselves the goal to involve the business community more and more, disseminating issues related to environment sustainability, economic and social; certain that "the genius" that arises from sharing, can lay the foundations to create new models of life and consumption.

From 2020 Plart Design decided to use recyclable or recycled material for its production processes. In this regard, an important agreement was signed with L'Oréal Saipo Industriale to regenerate end-of-life plastic in order to give it new life by producing new collection means to be reintroduced in the plant.



Le projet ricicli-AMO® a pour objectif de favoriser un résultat net avec des processus et des actes concrets une sensibilisation aux processus d'économie circulaire. Nous nous sommes fixés l'objectif de impliquer de plus en plus le monde des affaires, en diffusant les questions liées à la durabilité environnemental, économique et social, dans la certitude que « le génie » qui naît de la rencontre est du partage, peut poser les bases pour créer de nouveaux modèles de vie et de consommation.

A partir de 2020, Plart Design a décidé d'utiliser des matériaux recyclables pour ses processus de production ou recyclé. A ce titre, un accord important a été signé avec L'Oréal Saipo Industriale pour régénérer les matières plastiques en fin de vie utilisées afin de donner une seconde vie au plastique en produisant de nouveaux moyens de collecte à réintroduire dans l'usine.



El proyecto recida-AMO® tiene como finalidad favorecer un resultado neto con procesos y actos concretos Sensibilización sobre los procesos de economía circular. Nos fijamos el objetivo de involucrar cada vez más a la comunidad empresarial, difundiendo temas relacionados con la sostenibilidad. Ambiental, económica y social, en la certeza de que "el genio" que surge del encuentro es de compartir, puede sentar las bases para crear nuevos modelos de vida y consumo. Desde 2020 Plart Design ha decidido utilizar materiales reciclables para sus procesos productivos o reciclado. En este sentido, se firmó un importante acuerdo con L'Oréal Saipo Industriale para regenerar los materiales plásticos al final de su vida útil utilizados para darle una segunda vida al plástico mediante la producción de nuevos medios de recolección para ser reintroducidos en el pianto.

SUSTAINABLE CIRCULAR ECONOMY PROJECT



 *Il sole è la nostra fonte di ispirazione per realizzare prodotti di esclusivo design.
Arkema Design®, sostenibili per natura.*

 *The sun is our source of inspiration to create exclusive design products.
Arkema Design®, sustainable by nature.*

 *Le soleil est notre source d'inspiration pour créer des produits design exclusifs.
Arkema Design®, durable par nature.*

 *El sol es nuestra fuente de inspiración para crear productos de diseño exclusivos.
Arkema Design®, sostenible por naturaleza*



SUSTAINABLE CIRCULAR ECONOMY PROJECT



 In questo momento è fondamentale pensare in termini di Green Economy seguendo un modello di sviluppo sostenibile che tenga conto dell'impatto ambientale derivante dal progresso industriale. L'obiettivo è il modello di economia circolare, un modello di sviluppo scelto nel 2015 dalla Commissione Europea a seguito del World Economic Forum di Davos nel 2014.

La Vision di ARKEMA, azienda impegnata nel riciclo della plastica, individua nella sostenibilità la prospettiva e il futuro del mercato della plastica.

Attraverso attività di innovazione e ricerca e sviluppo, ARKEMA ha sviluppato prodotti in polvere dedicati allo stampaggio rotazionale, una vera innovazione per la produzione di beni durevoli in un'ottica di sostenibilità.

Nel mondo di oggi, fare affari non significa solo generare profitti, ma bensì andare oltre il core business, assumendosi la responsabilità sociale e ambientale delle proprie scelte.

 In this moment it is essential to think in terms of Green Economy by following a sustainable development model that takes into account the environmental impact as a result of industrial progress. The goal is the circular economy model, a development model chosen in 2015 by the European Commission following the World Economic Forum in Davos in 2014. The Vision of ARKEMA, a company committed to the recycling of plastic, identifies the prospect and future of the plastic market in sustainability.

Through innovation and R&D activities, ARKEMA developed powder products dedicated to rotational molding, a true innovation for the production of durable goods with a view to sustainability.

In today's world, doing business is not just about generating profits. Companies are realizing that the Mission must know how to go beyond the core business, taking social and environmental responsibilities for their choices.



RICICLO DELLA PLASTICA

PLASTIC RECYCLING

 Le materie plastiche di per sé non sono biodegradabili, possono resistere all'azione degli agenti atmosferici anche per centinaia di anni, ma se incenerite, generano sostanze tossiche, come la diossina.

Riciclare i rifiuti in plastica è il metodo più efficace per il loro smaltimento, tuttavia è possibile solo per alcuni tipi di plastica, e comporta costi e risultati differenti a seconda del materiale utilizzato.

 Plastic materials are not biodegradable, they can withstand weathering for hundreds of years. If incinerated, they generate toxic substances such as dioxin.

Recycling plastic waste is the most effective method of disposal, which is only possible for certain types of plastic, and involves different costs and results depending on the material used.

TIPI DI PLASTICA E CICLO DELLA PLASTICA

TYPES OF PLASTIC AND THE PLASTIC CYCLE

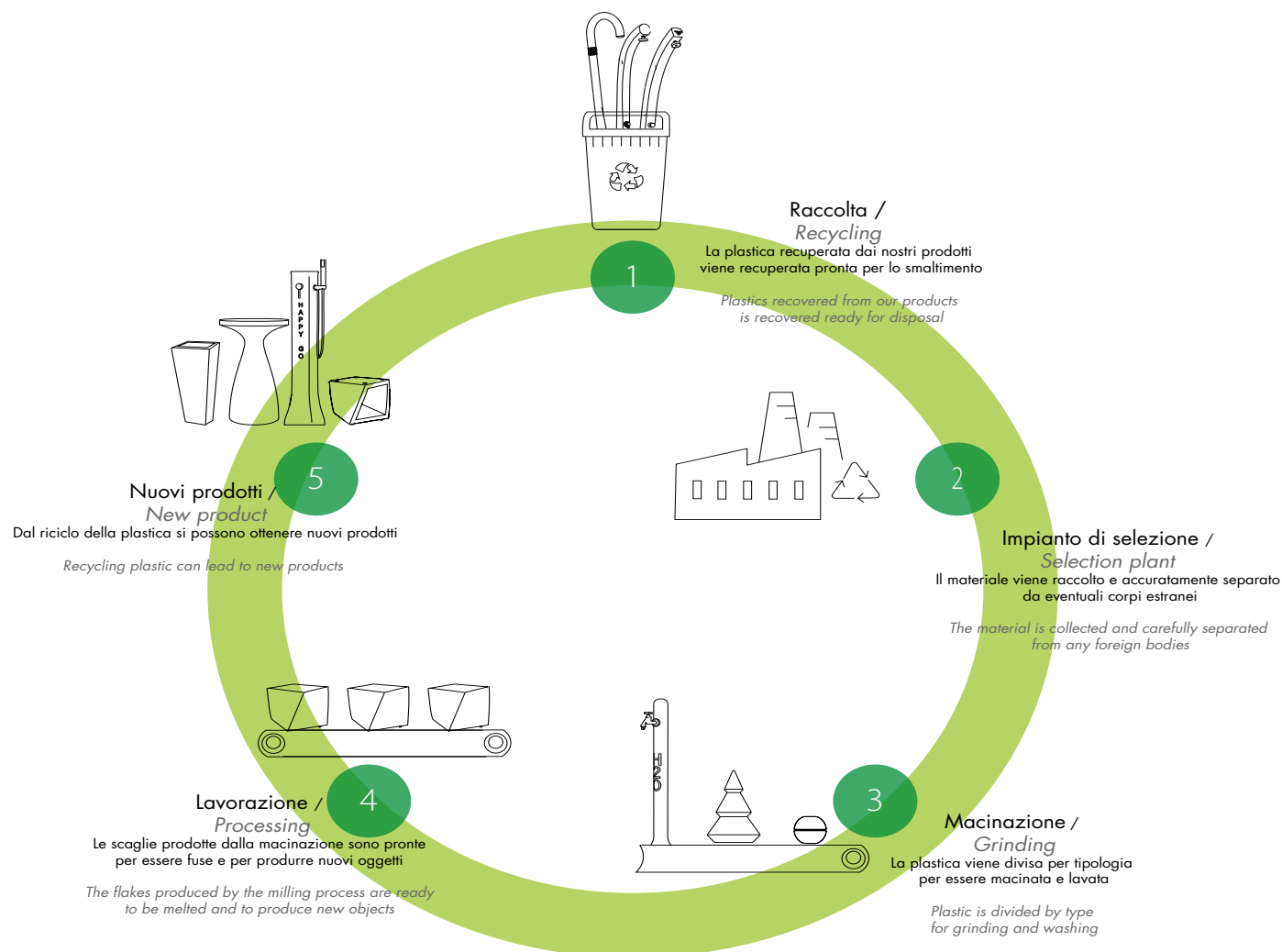

INDICE

INDEX



DOCCE A RISCALDAMENTO SOLARE
SOLAR SHOWERS
DOUCHES SOLAIRES
DUCHAS SOLARES

RESINA / RESIN

HAPPY	pg 30
NEW HAPPY	pg 32
HAPPY ONE	pg 34
HAPPY FIVE	pg 36
HAPPY BEACH	pg 38
HAPPY XL	pg 40
BIG HAPPY FIVE	pg 43

ALLUMINIO / ALUMINUM

JOLLY	pg 48
JOLLY S	pg 50
BIG JOLLY	pg 52
SPRING	pg 54
SPRING S	pg 56
DADA	pg 58
DADA S	pg 63
ENERGY PRO	pg 66

DOCCE TRADIZIONALI
TRADITIONAL SHOWERS
DOUCHES TRADITIONNELLES
DUCHAS TRADICIONALES

RESINA / RESIN

FUNNY YIN	pg 70
FUNNY YIN - D	pg 77
FUNNY YIN - F	pg 78
FUNNY YANG	pg 80
FUNNY YANG - D	pg 83
FUNNY YANG - F	pg 84
SPRING PLUS	pg 85

ALLUMINIO / ALUMINUM

JOLLY	pg 90
JOLLY S	pg 93
BIG JOLLY A 365/2	pg 94
BIG JOLLY A 365	pg 95
SPRING	pg 96
SPRING S	pg 98
DADA	pg 100
DADA S	pg 103
QUICK	pg 108
QUICK FOTOVOLTAICA	pg 114
QUICK - F	pg 117
QUICK FONTANA	pg 119
SANITY GATE	pg 122

TOP LINE

DOCCE SOLARI
SOLAR SHOWERS
DOUCHES SOLAIRES
DUCHAS SOLARES

JOLLY	pg 130
JOLLY PLUS	pg 132
SPRING	pg 134
DADA	pg 136
DADA S	pg 138

INDICE

INDEX

TOP LINE

DOCCE TRADIZIONALI
TRADITIONAL SHOWERS
DOUCHES TRADITIONNELLES
DUCHAS TRADICIONALES

FUNNY YIN	pg 142
FUNNY YIN - D	pg 147
FUNNY YANG	pg 148
FUNNY YANG - D	pg 149
JOLLY	pg 150
SPRING	pg 152
DADA S	pg 155

PIATTI DOCCIA
SHOWER BASE
RECEVEUR DE DOUCHE
BANDEJA DE DUCHA

PIATTO DOCCIA D 106	pg 161
PIATTO DOCCIA ECOWOOD D 107	pg 162
PIATTO DOCCIA LAKE D 108	pg 163
PIATTO DOCCIA OTTAGONALE QP110	pg 164

FONTANE
FOUNTAINS
FONTAINES
FUENTES

SOLARE / SOLAR

HAPPY GO	pg 169
JOLLY GO	pg 171

TRADIZIONALE / TRADITIONAL

H2O	pg 174
GARDEN SURPRISE	pg 176
JOLLY GO	pg 177
JOLLY LAVAPIEDI	pg 179
JOLLY FONTANA	pg 180
SPRING FONTANA	pg 181

COLLETTORE SOLARE
SOLAR COLLECTOR
COLLECTEUR SOLAIRE
COLECTOR SOLAR

HOTBALL	pg 190
SUN KEPT	pg 199
EGG BALL	pg 201

COMPLEMENTI E ACCESSORI
COMPLEMENTS AND ACCOSSORIES
COMPLÉMENTS ET ACCESSOIRES
COMPLEMENTOS Y ACCESORIOS

PIASTRELLE IN NOBILITATO D180	pg 204
FISSAGGIO A VITE D125	pg 205
STAFFA DI FISSAGGIO D120	pg 206
KIT FILTRO ANTICALCARE D150	pg 207
SACCO FODERA D170	pg 208
CESTELLO D200	pg 209

SERENDIPITY CHAISE LONGUE

SERENDIPITY CHAISE	pg 212
SERENDIPITY CHAISE HEATED	pg 213
SERENDIPITY CHAISE OUTDOOR	pg 214
SERENDIPITY CHAISE FLOATING	pg 215
ACCESSORI SERENDIPITY CHAISE	pg 216

SOLAR LIGHT

SF300	pg 226
SF400	pg 227
LIGHT STONE	pg 228
SOLAR BOA	pg 231
IRIS SL	pg 232
TWIST SL	pg 233
QUADRO 86 SL	pg 234
QUADRO 102 SL	pg 235
TONDO 86 SL	pg 236
TONDO 102 SL	pg 237
OSCA SL	pg 238
IRIS CONFORT SL	pg 239
PINO SL MEDIO	pg 240
FELIX SL	pg 241

NATURA LINE

POT	pg 244
QUADRO 86	pg 248
QUADRO 102	pg 249
TONDO 86	pg 250
TONDO 102	pg 251
TUMMY VASE	pg 252
IRIS VASE	pg 253
MODULO CASSETTA	pg 254

COMFORT LINE

DRINK	pg 258
KALISPERA	pg 259
FELIX	pg 260
ALTHEA	pg 261
OLIMPO	pg 262
LADY	pg 263
IRIS POUF	pg 264
IRIS CONFORT	pg 265
KAMI SGABELLO	pg 266
GAIA SGABELLO	pg 267
TWIST POUF	pg 268

STILE LINE

TULIPAN	pg 272
BOBO	pg 273
PISOLO	pg 274
ABETE S SMART	pg 275

ART DESIGN

FIORI E NOTE GRANDI	pg 278
QUADRO 86 ART	pg 279
QUADRO 102 ART	pg 280
POT M ART	pg 281



FINITURA E MATERIALI

MATERIALS AND FINISHING

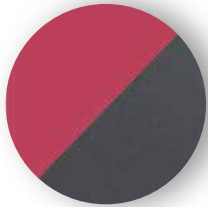

ALUMINIUM
POWDER PAINTED

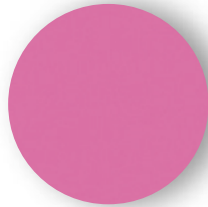

RESIN MASS
COLOURED



ANODIZED
ALUMINIUM



ALUMINIUM / RESIN
LIQUID PAINTING



RESIN STONE
EFFECT

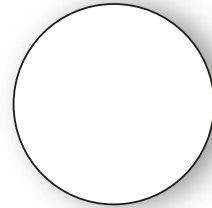

TRANSLUCENT
RESIN



WOOD



OKUMÈ WOOD



WRAPPING
ART BY
NESPOLO

STANDARD COLORS RESIN



RUBY
3003



ANTHRACITE
7016



GREEN
6016

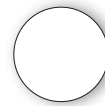

WHITE
9003

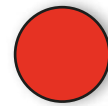

CHERRY
3027



DOVE GRAY
7030



BLUE
5002

SPECIAL COLORS RESIN

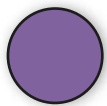

VIOLET
4005



FUXIA
4003



TURQUOISE
6033



COMET
SILVER
9006



ORANGE
2009



BLUE OCEAN
5021



WINE RED
3005



LIGHT GREEN
6018

COLOR LIGHT RESIN



NEUTRAL

STANDARD COLORS ALUMINIUM



CHAMPAGNE
BRONZE
1015



GREEN
6016



ANTHRACITE
7016



CHERRY
3027



GOLD
VANGOGH
8014



LIGHT BLUE
5012



SAND
9001

SPECIAL COLORS ALUMINIUM



ELECTRIC BLUE
5010



INOX
9007



ORANGE
2009



CORTEN
8004



GLOSSY JADE
6026



COBALT GLOSSY
5009



FUXIA
4003



VIOLET
4005



RED PASSION
3013

STANDARD COLORS QUICK



BIANCO
Bianco Lucido
Glossy White
9003-QL



ALLUMINIO
Alluminio Satinato
Satin Aluminium
9007-QL



ARDESIA
Ardesia Opaco
Matt Slate
7015-QL



OTTANIO
Ottanio Lucido Metallizzato
Teal Shiny Metallic
5021-QL

SPECIAL COLORS QUICK



ONICE AMBRATO
Onice Nero/Oro
Amber Onyx Black/Gold
M001



CARRARA
Marmo Bianco
White Marble
M002



CARBONIO
Carbonio Nero/Verde
Green/Black Carbon
C001

COLLECTOR COLORS



ANTHRACITE
7016



STONE EFFECT
(Only Egg Ball)

STANDARD COLORS TOPLINE



ORO SATINATO
SATINE
1200



PERLA NERA
SLIGHTLY METALISED
7300



PERLA BIANCA
SHINY PEARL
9400



SMERALDO
SLIGHTLY METALISED
6700

SPECIAL COLORS TOPLINE



RAME
SLIGHTLY METALISED
1100



ARGENTO
SLIGHTLY METALISED
1300



ZAFFIRO
SLIGHTLY METALISED
5600



RUBINO
SLIGHTLY METALISED
3500

LEGENDA/LEGEND:



DOCCIA FONTANA SOLARE/
SOLAR SHOWER/FOUNTAIN



PESO A VUOTO/
EMPTY WEIGHT



DOCCIA FONTANA TRADIZIONALE/
TRADITIONAL SHOWER



CAPIENZA/
CAPACITY



RISPARMIO IDRICO/
WATER SAVING



INGOMBRO DELL'IMBALLAGGIO/
PACKAGING SIZE



LUCE SOLARE/
SOLAR LIGHT



LUCI LED/
LED LIGHTS



MATERIALE RICICLATO O RICICLABILE/
RECYCLED OR RECYCLABLE MATERIAL

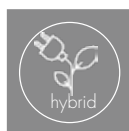

IBRIDA/
HYBRID

OPZIONI/OPTION:

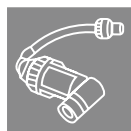

KIT FILTRO ANTICALCARE/
SCALE FILTER KIT



SACCO FODERA/
LINING BAG



ACCESSORI NEW 2025/
2025 NEW ACCESSORISE EDITION

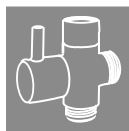

DEVIATORE*/
DIVERTER*

*Il deviatore è l'accessorio che permette di avere acqua miscelata dalla doccetta e di attivare il nebulizzatore/ *The diverter is the accessory that provides hot water from the hand shower and the nebuliser*

MODELLI PRODOTTI/ MODELS PRODUCTS: D350, D440, D450, T355, T145-D, T245-D, A365, D445TL, D455TL, T145-D-TL, T245-D-TL, T355-TL

NOTE INFORMATIVE/INFORMATION NOTES:

*PER TUTTI I MODELLI DI FUNNY, PER LA JOLLY A365 E PER LA FONTANA H20 è possibile scegliere il posizionamento dell'attacco nella fase d'ordine, questo può essere: ATTACCO DOCCIA PAVIMENTO O LATERALE.

FOR ALL FUNNY MODELS, FOR THE JOLLY A365 AND FOR THE H20 FOUNTAIN it is possible to choose the positioning of the connection during the order, this can be: FLOOR OR SIDE SHOWER CONNECTION.

COLLEGAMENTO AL SISTEMA IDRICO CONNECTION TO THE WATER SYSTEM

CAPACITÀ SERBATOIO/
TANK CAPACITY

CAPACITÀ ATTUALE/
ACTUAL CAPACITY

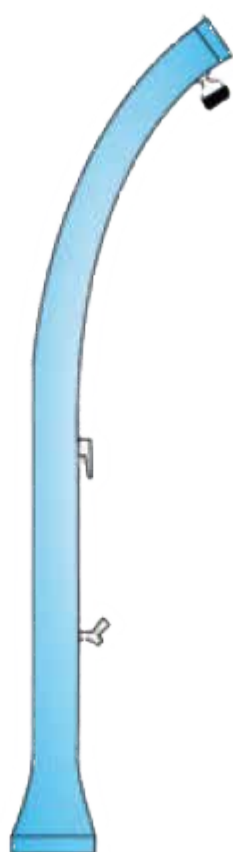

CARICO D'ACQUA/
WATER LOAD

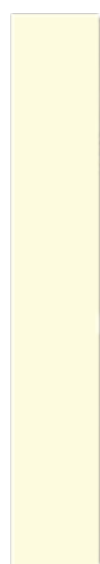

ACQUA FREDDA
ALLA DOCCIA/
COLD WATER
TO THE SHOWER

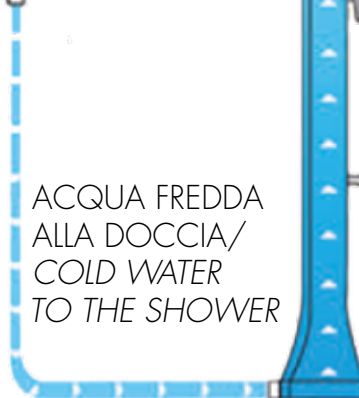

ACQUA CALDA/
HOT WATER



SVUOTARE IL SERBATOIO DURANTE LA CHIUSURA INVERNALE
EMPTY THE TANK DURING WINTER CLOSING



TEST TEMPERATURA PER LE DOCCE SOLARI

SOLAR SHOWER HEATING TEST

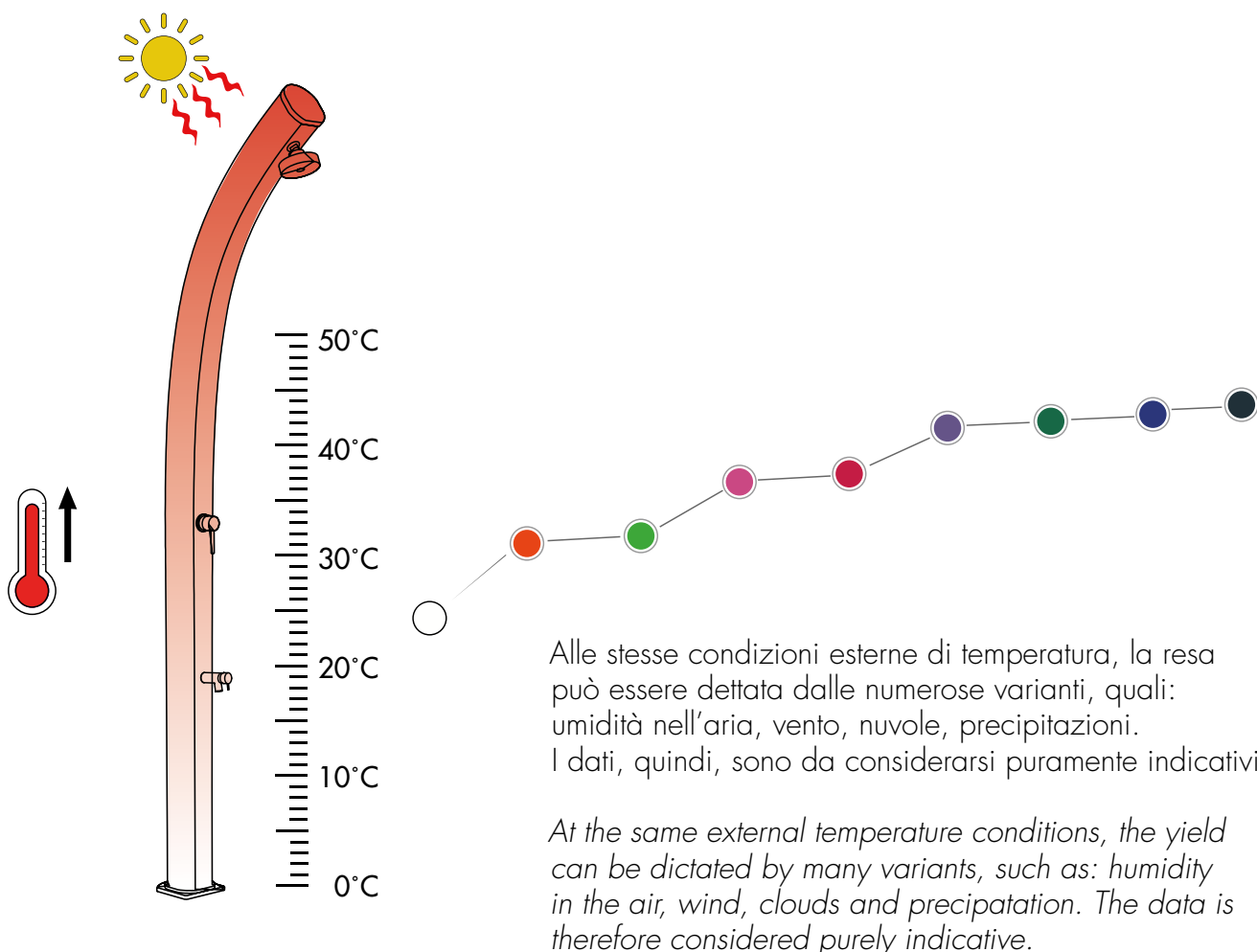

TEST CONDITIONS:

DAY: 07/08/2016 - 11.30 AM - **ATMOSPHERIC CONDITIONS:** SUNSHINE WITHOUT WIND

OUTSIDE TEMPERATURE: 27° C - **INLET WATER TEMPERATURE:** 12° C - **EXPOSURE OF RETRO SOLAR SHOWER:** SOUTH

MODELS	DESCRIPTIONS	MATERIAL	WATER HEAT ON EXIT C°		
			10 minutes	30 minutes	60 minutes
H120/7016	HAPPY ANTHRACITE	POLYETHYLENE	26° C	30° C	34° C
H120/9003	HAPPY WHITE	POLYETHYLENE	24° C	25° C	26° C
A520/7016	JOLLY ANTHRACITE	POLYETHYLENE	29° C	31° C	36° C
A520/9001	JOLLY SAND	ALLUMINIUM	26° C	28° C	30° C
A100/7016	SPRING ANTHRACITE	ALLUMINIUM	29° C	36° C	42° C
A100/9001	SPRING SAND	ALLUMINIUM	26° C	29° C	32° C
D300/7016	DADA ANTHRACITE	ALLUMINIUM	29° C	36° C	41° C
D300/9001	DADA SAND	ALLUMINIUM	26° C	28° C	31° C
A920/7016	ENERGY PRO ANTHRACITE	ALLUMINIUM	31° C	34° C	38° C
A920/7016	ENERGY PRO SAND	ALLUMINIUM	24° C	26° C	29° C

KIT DEALER

Uno strumento di field marketing al supporto del punto vendita

SHOWER EXIBITHOR

1 PCS.



FLYER HOLDER TOTEM 73 X 65 X h145 cm

1 PCS.



AUTHORIZED DEALER PATCH

2 PCS.



FLYER

100 PCS.



DEALER CATALOGUE

2 PCS.

POLYETHYLENE AND ALUMINIUM

1 PCS.



CONFEZIONE

IMBALLAGGIO FAMIGLIA

Tutti gli imballaggi sono stati progettati seguendo un'unica linea grafica, in modo da risultare visivamente il più possibile uniformi.

IMBALLAGGIO ECOLOGICO

L'imballo è tutto in cartone vulcanico, riutilizzabile più volte e riciclabile al 100%.

ESPORTAZIONE CERTIFICATA

tutte le confezioni sono certificate e conformi alle normative europee normative sull'esportazione, al fine di garantire la massima sicurezza nel settore dei trasporti.

PACKAGING

PACKAGING

All packaging has been designed following a single graphic line, to be as visually uniform as possible.

ECOLOGICAL PACKAGING

The packaging is all made of vulcanic cardboard, reusable several times and 100% recyclable.

CERTIFIED EXPORT

all packages are certified and comply with European export regulations, in order to guarantee maximum safety in the field of transport.





**SOLAR
SHOWERS**

RESIN



COLORS

STANDARD COLORS RESIN

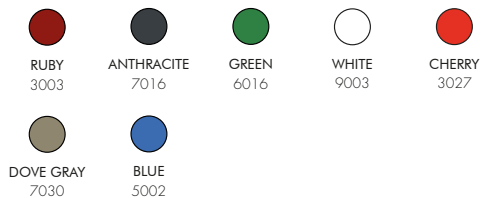

SPECIAL COLORS RESIN



*EXTRA FOR SPECIAL COLORS



HAPPY H100

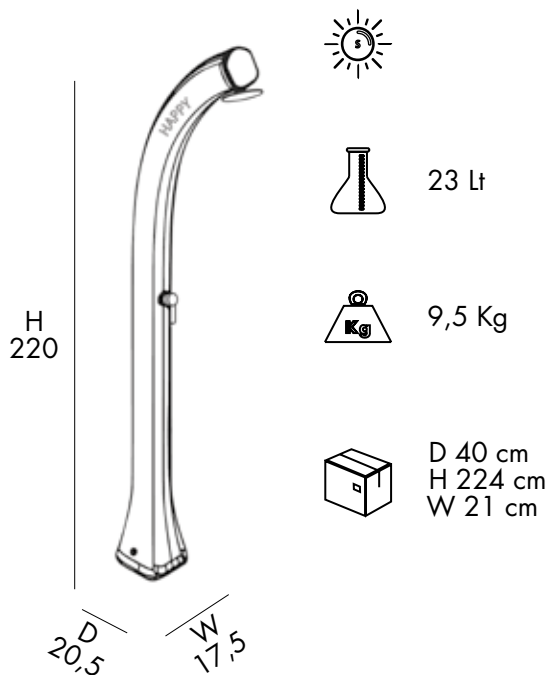

DOCCIA SOLARE

- SOFFIONE NEW IN INOX
- MISCELATORE
- REALIZZATA IN POLIETILENE COLORATO IN MASSA
- ACCESSORI IN OTTONE ABS CROMATO
- ATTACCO DOCCIA LATERALE DESTRO

SOLAR SHOWER

- NEW STAINLESS STEEL SHOWER HEAD
- MIXER
- MADE OF MASS COLORED HD POLYETHYLENE
- ACCESSORIES IN CHROMED BRASS AND CHROMED ABS
- RIGHT SIDE SHOWER ATTACHMENT

DOUCHE SOLAIRE

- POMME DE DOUCHE NEW INOX
- MITIGEUR
- FABRIQUÉE EN POLYÉTHYLÈNE COLORÉ DANS LA MASSE
- ACCESSOIRES EN LAITON CHROMÉ ET ABS
- RACCORD DE DOUCHE COTÉ DROIT

DUCHA SOLAR

- CABEZA DE DUCHA NEW EN INOXA
- MEZCLADOR
- REALIZADA EN POLIETILENO COLOREADO A GRANEL EN MASE
- ACCESORIOS DE LATÓN CROMADO Y ABS CROMO
- ACCESORIO DE DUCHA DEL LADO DERECHO



COLORS

STANDARD COLORS RESIN

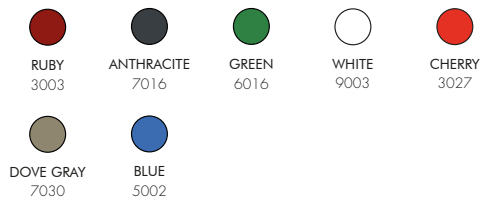

SPECIAL COLORS RESIN



*EXTRA FOR
SPECIAL COLORS

€

HAPPY H120

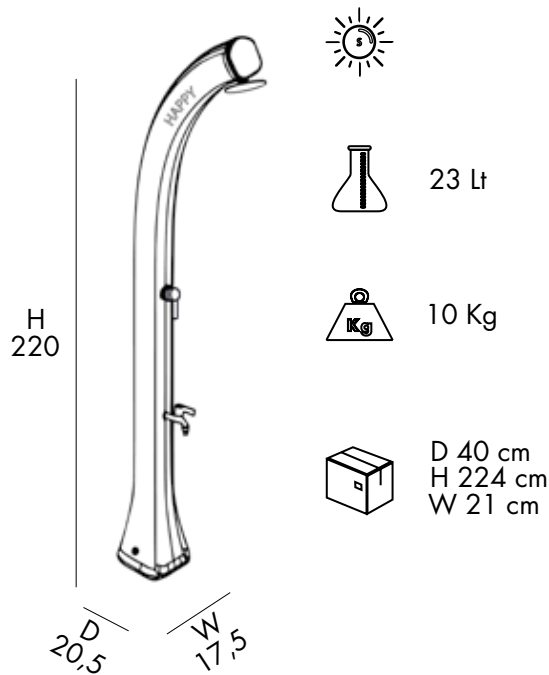

DOCCIA SOLARE

- SOFFIONE NEW IN INOX
- MISCELATORE
- RUBINETTO LAVAPIEDI
- REALIZZATA IN POLIETILENE COLORATO IN MASSA
- ACCESSORI IN OTTONE ABS CROMATO
- ATTACCO DOCCIA LATERALE DESTRO

SOLAR SHOWER

- NEW STAINLESS STEEL SHOWER HEAD
- MIXER
- FOOTWASHER
- MADE OF MASS COLORED HD POLYETHYLENE
- ACCESSORIES IN CHROMED BRASS AND CHROMED ABS
- RIGHT SIDE SHOWER ATTACHMENT

DOUCHE SOLAIRE

- POMME DE DOUCHE NEW INOX
- MITIGEUR
- RINCE PIEDS
- FABRIQUÉE EN POLYÉTHYLÈNE COLORÉ DANS LA MASSE
- ACCESSOIRES EN LAITON CHROMÉ ET ABS
- RACCORD DE DOUCHE COTÉ DROIT

DUCHA SOLAR

- CABEZA DE DUCHA NEW EN INOX
- MEZCLADOR
- LAVAPIES
- REALIZADA EN POLIETILENO COLOREADO A GRANEL EN MASA
- ACCESORIOS DE LATÓN CROMADO Y ABS CROMO
- ACCESORIO DE DUCHA DEL LADO DERECHO

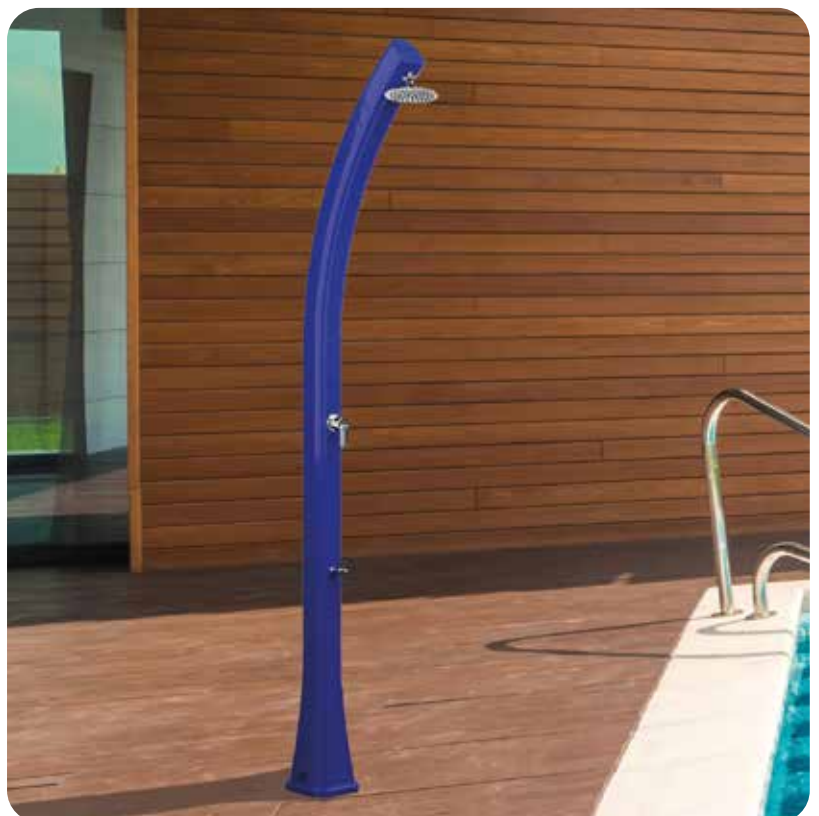

COLORS

STANDARD COLORS RESIN

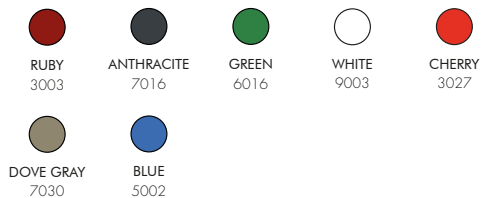

SPECIAL COLORS RESIN



*EXTRA FOR SPECIAL COLORS



NEW HAPPY H200

NEW PRODUCT

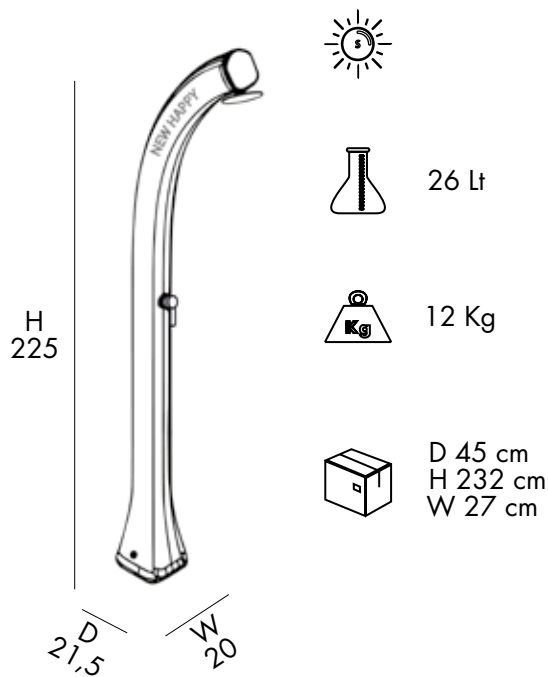

DOCCIA SOLARE

- SOFFIONE NEW IN INOX
- MISCELATORE NEW
- REALIZZATA IN POLIETILENE COLORATO IN MASSA
- ACCESSORI IN OTTONE CROMATO
- ATTACCO POSTERIORE

SOLAR SHOWER

- NEW STAINLESS STEEL SHOWER HEAD
- NEW MIXER
- MADE OF MASS COLORED HD POLYETHYLENE
- ACCESSORIES IN CHROMED BRASS
- REAR SHOWER ATTACHMENT

DOUCHE SOLAIRE

- POMME DE DOUCHE NEW INOX
- MITIGEUR NEW
- FABRIQUÉE EN POLYÉTHYLÈNE COLORÉ DANS LA MASSE
- ACCESSOIRES EN LAITON CHROMÉ
- RACCORD DE DOUCHE ARRIÈRE

DUCHA SOLAR

- CABEZA DE DUCHA NEW EN INOX
- MEZCLADOR NEW
- REALIZADA EN POLIETILENO COLOREADO A GRANEL EN MASE
- ACCESORIOS DE LATÓN CROMADO Y CROMO
- ACCESORIO DE DUCHA TRASERA



COLORS

STANDARD COLORS RESIN

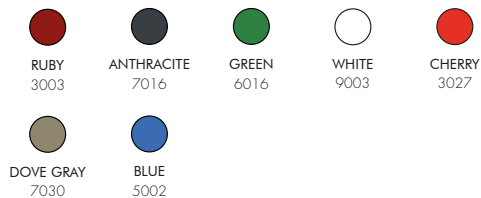

SPECIAL COLORS RESIN



*EXTRA FOR
SPECIAL COLORS

€

NEW HAPPY H220

NEW PRODUCT

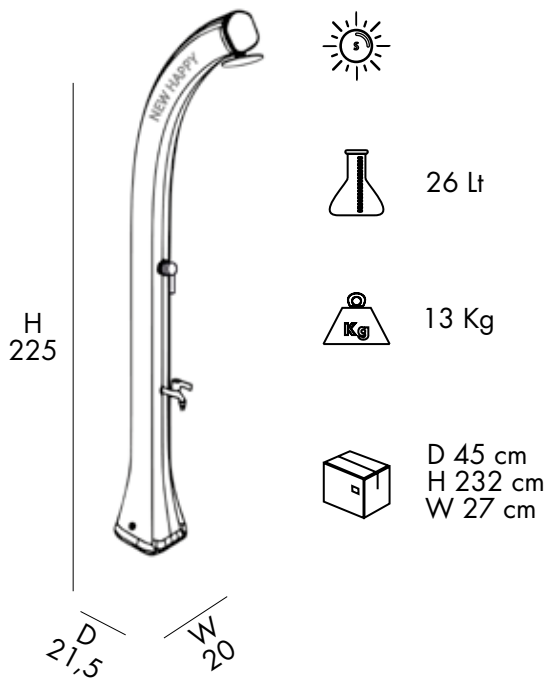

DOCCIA SOLARE

- SOFFIONE NEW IN INOX
- MISCELATORE NEW
- LAVAPIEDI
- REALIZZATA IN POLIETILENE COLORATO IN MASSA
- ACCESSORI IN OTTONE CROMATO
- ATTACCO POSTERIORE

SOLAR SHOWER

- NEW STAINLESS STEEL SHOWER HEAD
- NEW MIXER
- FOOTWASHER
- MADE OF MASS COLORED HD POLYETHYLENE
- ACCESSORIES IN CHROMED BRASS
- REAR SHOWER ATTACHMENT

DOUCHE SOLAIRE

- POMME DE DOUCHE NEW INOX
- MITIGEUR NEW
- RINCE PIEDS
- FABRIQUÉE EN POLYÉTHYLÈNE COLORÉ DANS LA MASSE
- ACCESSOIRES EN LAITON CHROMÉ ET ABS
- RACCORD DE DOUCHE ARRIÈRE

DUCHA SOLAR

- CABEZA DE DUCHA NEW EN INOX
- MEZCLADOR NEW
- LAVAPIES
- REALIZADA EN POLIETILENO COLOREADO A GRANEL EN MASE
- ACCESORIOS DE LATÓN CROMADO Y ABS CROMO
- ACCESORIO DE DUCHA TRASERA



COLORS

STANDARD COLORS RESIN

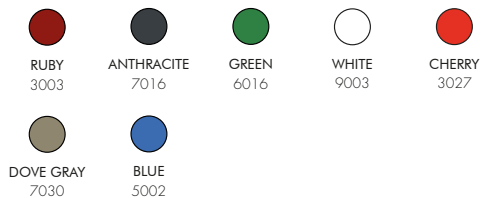

SPECIAL COLORS RESIN



*EXTRA FOR
SPECIAL COLORS



HAPPY ONE F100

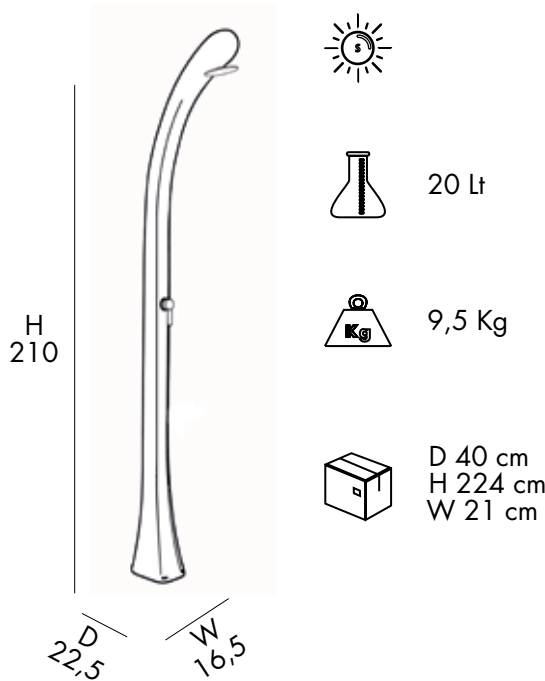

DOCCIA SOLARE

- SOFFIONE NEW IN INOX
- MISCELATORE
- REALIZZATA IN POLIETILENE COLORATO IN MASSA
- ACCESSORI IN OTTONE ABS CROMATO
- ATTACCO DOCCIA POSTERIORE

SOLAR SHOWER

- NEW STAINLESS STEEL SHOWER HEAD
- MIXER
- MADE OF MASS COLORED HD POLYETHYLENE
- ACCESSORIES IN CHROMED BRASS AND CHROMED ABS
- REAR SHOWER ATTACHMENT

DOUCHE SOLAIRE

- POMME DE DOUCHE NEW INOX
- MITIGEUR
- FABRIQUÉE EN POLYÉTHYLÈNE COLORÉ DANS LA MASSE
- ACCESSOIRES EN LAITON CHROMÉ ET ABS
- RACCORD DE DOUCHE ARRIÈRE

DUCHA SOLAR

- CABEZA DE DUCHA NEW EN INOX
- MEZCLADOR
- REALIZADA EN POLIETILENO COLOREADO A GRANEL EN MASE
- ACCESORIOS DE LATÓN CROMADO Y ABS CROMO
- ACCESORIO DE DUCHA TRASERA



COLORS

STANDARD COLORS RESIN

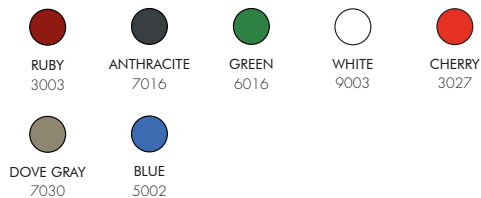

SPECIAL COLORS RESIN



*EXTRA FOR
SPECIAL COLORS

€

HAPPY ONE F120

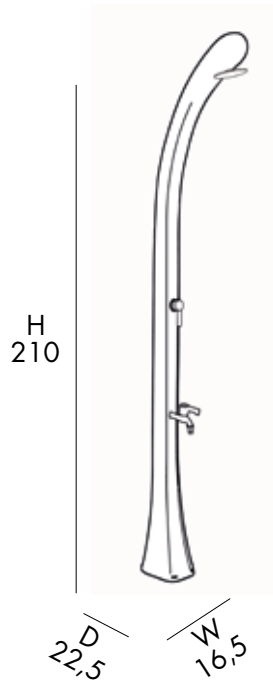

20 Lt



10 Kg



D 40 cm
H 224 cm
W 21 cm



DOCCIA SOLARE

- SOFFIONE NEW IN INOX
- MISCELATORE
- RUBINETTO LAVAPIEDI
- REALIZZATA IN POLIETILENE COLORATO IN MASSA
- ACCESSORI IN OTTONE ABS CROMATO
- ATTACCO DOCCIA POSTERIORE

SOLAR SHOWER

- NEW STAINLESS STEEL SHOWER HEAD
- MIXER
- FOOTWASHER TAP
- MADE OF MASS COLORED HD POLYETHYLENE
- ACCESSORIES IN CHROMED BRASS AND CHROMED ABS
- REAR SHOWER ATTACHMENT

DOUCHE SOLAIRE

- POMME DE DOUCHE NEW INOX
- MITIGEUR
- RINCE PIEDS
- FABRIQUÉE EN POLYÉTHYLÈNE COLORÉ DANS LA MASSE
- ACCESSOIRES EN LAITON CHROMÉ ET ABS
- RACCORD DE DOUCHE ARRIÈRE

DUCHA SOLAR

- CABEZA DE DUCHA NEW EN INOX
- MEZCLADOR
- LAVAPIES
- REALIZADA EN POLIETILENO COLOREADO A GRANEL EN MASE
- ACCESORIOS DE LATÓN CROMADO Y ABS CROMO
- ACCESORIO DE DUCHA TRASERA



COLORS

STANDARD COLORS RESIN

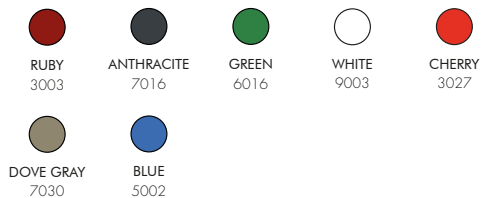

SPECIAL COLORS RESIN



*EXTRA FOR
SPECIAL COLORS



HAPPY FIVE F500



DOCCIA SOLARE

- SOFFIONE NEW IN INOX
- MISCELATORE
- REALIZZATA IN POLIETILENE COLORATO IN MASSA
- ACCESSORI IN OTTONE ABS CROMATO
- ATTACCO DOCCIA POSTERIORE

SOLAR SHOWER

- NEW STAINLESS STEEL SHOWER HEAD
- MIXER
- MADE OF MASS COLORED HD POLYETHYLENE
- ACCESSORIES IN CHROMED BRASS AND CHROMED ABS
- REAR SHOWER ATTACHMENT

DOUCHE SOLAIRE

- POMME DE DOUCHE NEW INOX
- MITIGEUR
- FABRIQUÉE EN POLYÉTHYLÈNE COLORÉ DANS LA MASSE
- ACCESSOIRES EN LAITON CHROMÉ ET ABS
- RACCORD DE DOUCHE ARRIÈRE

DUCHA SOLAR

- CABEZA DE DUCHA NEW EN INOX
- MEZCLADOR
- REALIZADA EN POLIETILENO COLOREADO A GRANTEL EN MASE
- ACCESORIOS DE LATÓN CROMADO Y ABS CROMO
- ACCESORIO DE DUCHA TRASERA



COLORS

STANDARD COLORS RESIN

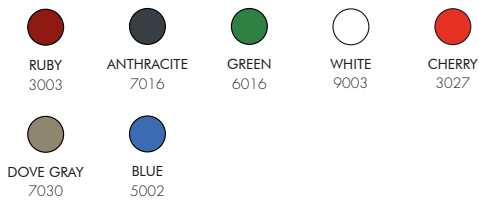

SPECIAL COLORS RESIN



*EXTRA FOR
SPECIAL COLORS

€

HAPPY FIVE F520

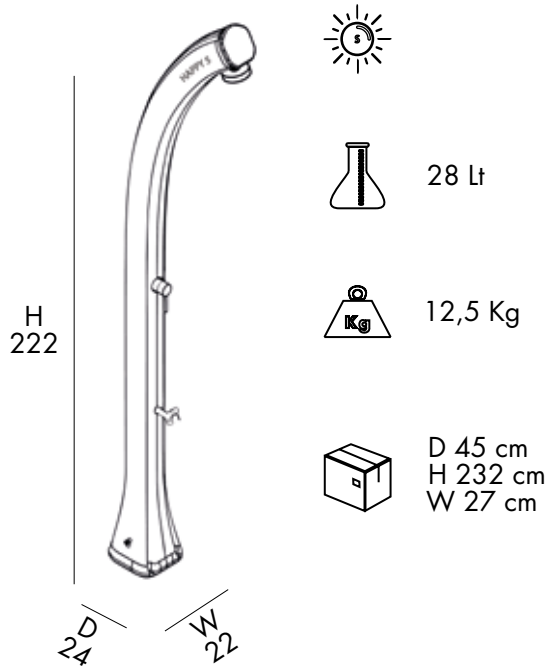

DOCCIA SOLARE

- SOFFIONE NEW IN INOX
- MISCELATORE
- LAVAPIEDI
- REALIZZATA IN POLIETILENE COLORATO IN MASSA
- ACCESSORI IN OTTONE ABS CROMATO
- ATTACCO DOCCIA POSTERIORE

SOLAR SHOWER

- NEW STAINLESS STEEL SHOWER HEAD
- MIXER
- FOOTWASHER TAP
- MADE OF MASS COLORED HD POLYETHYLENE
- ACCESSORIES IN CHROMED BRASS AND CHROMED ABS
- REAR SHOWER ATTACHMENT

DOUCHE SOLAIRE

- POMME DE DOUCHE NEW INOX
- MITIGEUR
- RINCE PIEDS
- FABRIQUÉE EN POLYÉTHYLÈNE COLORÉ DANS LA MASSE
- ACCESSOIRES EN LAITON CHROMÉ ET ABS
- RACCORD DE DOUCHE ARRIÈRE

DUCHA SOLAR

- CABEZA DE DUCHA NEW EN INOX
- MEZCLADOR
- LAVAPIES
- REALIZADA EN POLIETILENO COLOREADO A GRANEL EN MASE
- ACCESORIOS DE LATÓN CROMADO Y ABS CROMO
- ACCESORIO DE DUCHA TRASERA



COLORS

STANDARD COLORS RESIN

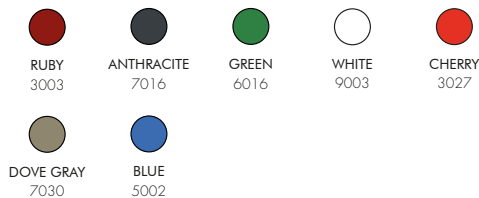

SPECIAL COLORS RESIN



*EXTRA FOR
SPECIAL COLORS



HAPPY BEACH F530

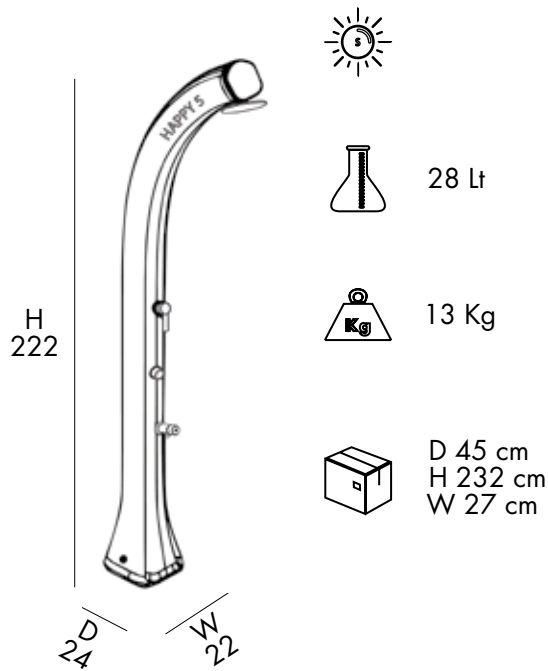

DOCCIA SOLARE

- SOFFIONE NEW IN INOX • MISCELATORE
- TEMPORIZZATORE
- LAVAPIEDI TEMPORIZZATO
- REALIZZATA IN POLIETILENE COLORATO IN MASSA
- ACCESSORI IN OTTONE ABS CROMATO
- ATTACCO DOCCIA POSTERIORE

SOLAR SHOWER

- NEW STAINLESS STEEL SHOWER HEAD • MIXER
- TEMPORIZED BUTTON
- TEMPORIZED FOOTWASHER
- MADE OF MASS COLORED HD POLYETHYLENE
- ACCESSORIES IN CHROMED BRASS AND CHROMED ABS
- REAR SHOWER ATTACHMENT

DOUCHE SOLAIRE

- POMME DE DOUCHE NEW INOX • MITIGEUR
- BOUTON TEMPORISÉ
- RINCE PIEDS TEMPORISÉ
- FABRIQUÉE EN POLYÉTHYLÈNE COLORÉ DANS LA MASSE
- ACCESSOIRES EN LAITON CHROMÉ ET ABS
- RACCORD DE DOUCHE ARRIÈRE

DUCHA SOLAR

- CABEZA DE DUCHA NEW EN INOX • MEZCLADOR
- BOTÓN TEMPORIZADO
- LAVAPIES TEMPORIZADO
- REALIZADA EN POLIETILENO COLOREADA A GRANEL EN MASE
- ACCESORIOS DE LATÓN CROMADO Y ABS CROMO
- ACCESORIO DE DUCHA TRASERA



COLORS

STANDARD COLORS RESIN

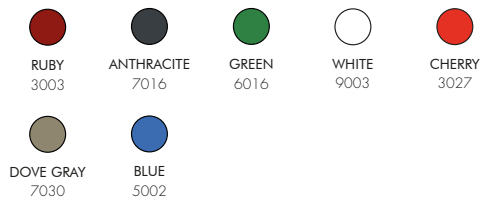

SPECIAL COLORS RESIN



*EXTRA FOR
SPECIAL COLORS

€

HAPPY BEACH F560

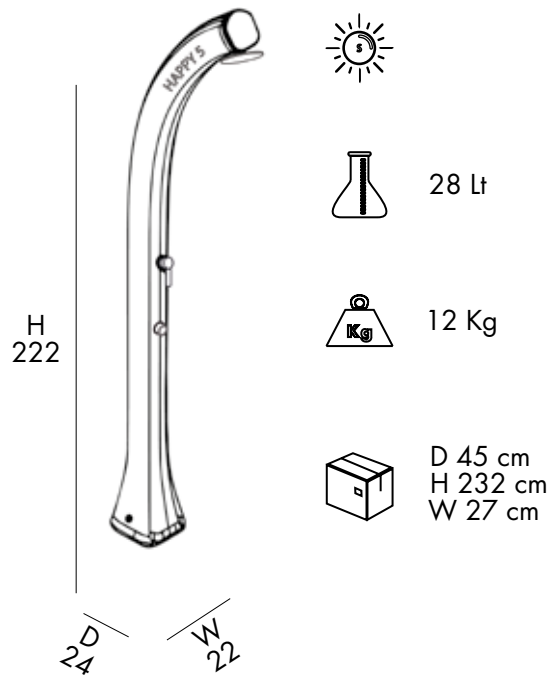

DOCCIA SOLARE

- SOFFIONE NEW IN INOX
- MISCELATORE
- TEMPORIZZATORE
- REALIZZATA IN POLIETILENE COLORATO IN MASSA
- ACCESSORI IN OTTONE ABS CROMATO
- ATTACCO DOCCIA POSTERIORE

SOLAR SHOWER

- NEW STAINLESS STEEL SHOWER HEAD
- MIXER
- TEMPORIZED BUTTON
- MADE OF MASS COLORED HD POLYETHYLENE
- ACCESSORIES IN CHROMED BRASS AND CHROMED ABS
- REAR SHOWER ATTACHMENT

DOUCHE SOLAIRE

- POMME DE DOUCHE NEW INOX
- MITIGEUR
- BOUTON TEMPORISÉ
- FABRIQUÉE EN POLYÉTHYLÈNE COLORÉ DANS LA MASSE
- ACCESSOIRES EN LAITON CHROMÉ ET ABS
- RACCORD DE DOUCHE ARRIÈRE

DUCHA SOLAR

- CABEZA DE DUCHA NEW EN INOX
- MEZCLADOR
- BOTÓN TEMPORIZADO
- REALIZADA EN POLIETILENO COLOREADO A GRANEL EN MASE
- ACCESORIOS DE LATÓN CROMADO Y ABS CROMO
- ACCESORIO DE DUCHA TRASERA



COLORS

STANDARD COLORS RESIN

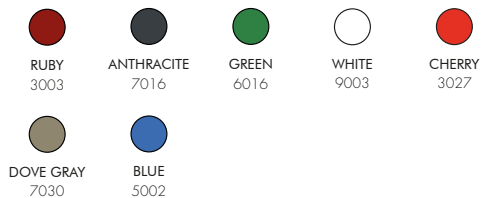

SPECIAL COLORS RESIN



*EXTRA FOR SPECIAL COLORS



HAPPY XL H400



DOCCIA SOLARE

- SOFFIONE NEW IN INOX
- MISCELATORE
- REALIZZATA IN POLIETILENE COLORATO IN MASSA
- ACCESSORI IN OTTONE ABS CROMATO
- ATTACCO DOCCIA LATERALE DESTRO

SOLAR SHOWER

- NEW STAINLESS STEEL SHOWER HEAD
- MIXER
- MADE OF MASS COLORED HD POLYETHYLENE
- ACCESSORIES IN CHROMED BRASS AND CHROMED ABS
- RIGHT SIDE SHOWER ATTACHMENT

DOUCHE SOLAIRE

- POMME DE DOUCHE NEW INOX
- MITIGEUR
- FABRIQUÉE EN POLYÉTHYLÈNE COLORÉ DANS LA MASSE
- ACCESSOIRES EN LAITON CHROMÉ ET ABS
- RACCORD DE DOUCHE COTÉ DROIT

DUCHA SOLAR

- CABEZA DE DUCHA NEW EN INOX
- MEZCLADOR
- REALIZADA EN POLIETILENO COLOREADO A GRANEL EN MASE
- ACCESORIOS DE LATÓN CROMADO Y ABS CROMO
- ACCESORIO DE DUCHA DEL LADO DERECHO



COLORS

STANDARD COLORS RESIN

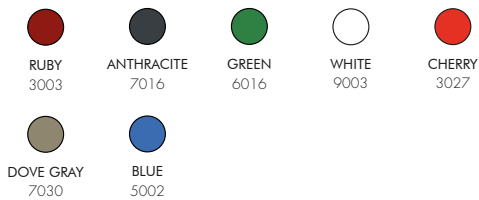

SPECIAL COLORS RESIN



*EXTRA FOR
SPECIAL COLORS

€

HAPPY XL H420

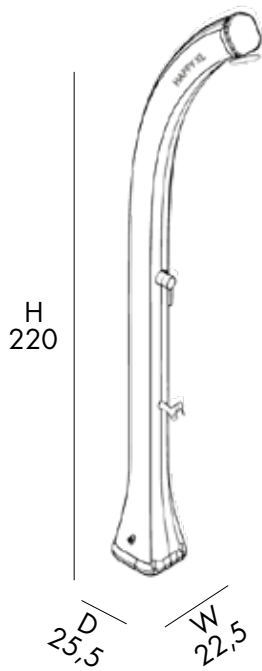

35 Lt



15,5 Kg



D 54 cm
H 230 cm
W 28 cm

DOCCIA SOLARE

- SOFFIONE NEW IN INOX
- MISCELATORE
- LAVAPIEDI
- REALIZZATA IN POLIETILENE COLORATO IN MASSA
- ACCESSORI IN OTTONE ABS CROMATO
- ATTACCO DOCCIA LATERALE DESTRO

SOLAR SHOWER

- NEW STAINLESS STEEL SHOWER HEAD
- MIXER
- FOOTWASHER
- MADE OF MASS COLORED HD POLYETHYLENE
- ACCESSORIES IN CHROMED BRASS AND CHROMED ABS
- RIGHT SIDE SHOWER ATTACHMENT

DOUCHE SOLAIRE

- POMME DE DOUCHE NEW INOX
- MITIGEUR
- RINCE PIEDS
- FABRIQUÉE EN POLYÉTHYLÈNE COLORÉ DANS LA MASSE
- ACCESSOIRES EN LAITON CHROMÉ ET ABS
- RACCORD DE DOUCHE COTÉ DROIT

DUCHA SOLAR

- CABEZA DE DUCHA NEW EN INOX
- MEZCLADOR • LAVAPIES
- BOTÓN TEMPORIZADO
- REALIZADA EN POLIETILENO COLOREADO A GRANEL EN MASE
- ACCESORIOS DE LATÓN CROMADO Y ABS CROMO
- ACCESORIO DE DUCHA DEL LADO DERECHO



COLORS

STANDARD COLORS RESIN

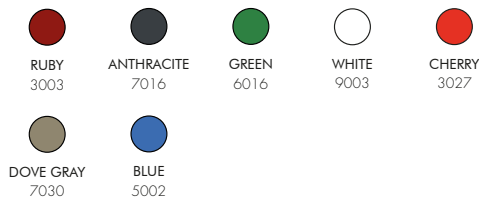

SPECIAL COLORS RESIN



*EXTRA FOR SPECIAL COLORS

€

HAPPY XL H430

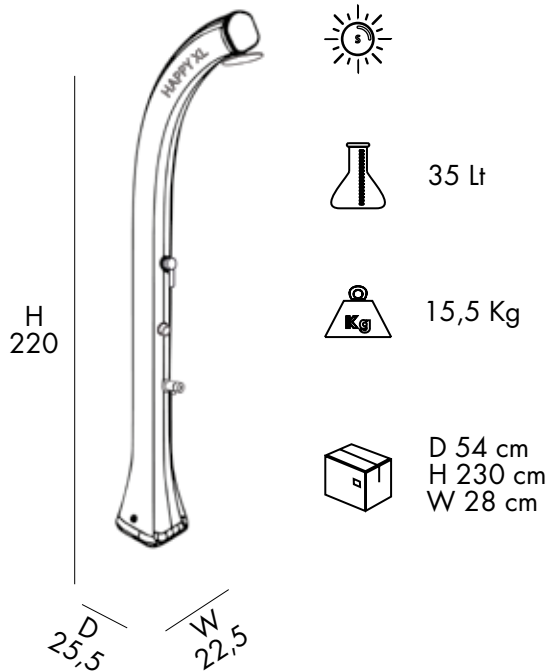

DOCCIA SOLARE

- SOFFIONE NEW IN INOX
- MISCELATORE
- LAVAPIEDI TEMPORIZZATO • TEMPORIZZATORE
- REALIZZATA IN POLIETILENE COLORATO IN MASSA
- ACCESSORI IN OTTONE ABS CROMATO
- ATTACCO DOCCIA LATERALE DESTRO

SOLAR SHOWER

- NEW STAINLESS STEEL SHOWER HEAD
- MIXER
- TEMPORIZED FOOTWASHER • TEMPORIZED BUTTON
- MADE OF MASS COLORED HD POLYETHYLENE
- ACCESSORIES IN CHROMED BRASS AND CHROMED ABS
- RIGHT SIDE SHOWER ATTACHMENT

DOUCHE SOLAIRE

- POMME DE DOUCHE NEW INOX
- MITIGEUR
- RINCE PIEDS TEMPORISÉ • BOUTON TEMPORISÉ
- FABRIQUÉE EN POLYÉTHYLÈNE COLORÉ DANS LA MASSE
- ACCESSOIRES EN LAITON CHROMÉ ET ABS
- RACCORD DE DOUCHE COTÉ DROIT

DUCHA SOLAR

- CABEZA DE DUCHA NEW EN INOX
- MEZCLADOR
- LAVAPIES TEMPORIZADO • BOTÓN TEMPORIZADO
- REALIZADA EN POLIETILENO COLOREADO A GRAN EL EN MASE
- ACCESORIOS DE LATÓN CROMADO Y ABS CROMO
- ACCESORIO DE DUCHA DEL LADO DERECHO



COLORS

STANDARD COLORS RESIN

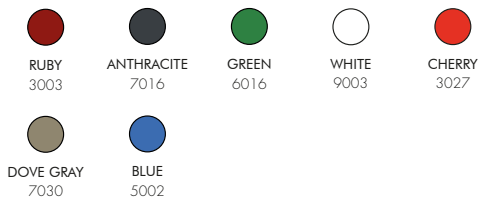

SPECIAL COLORS RESIN



*EXTRA FOR
SPECIAL COLORS

€

BIG HAPPY FIVE F600

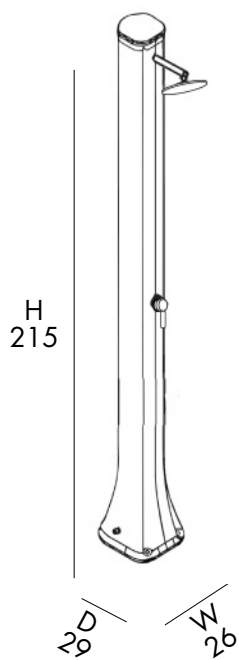

36 Lt



14,5 Kg



D 32 cm
H 221 cm
W 26 cm

DOCCIA SOLARE

- SOFFIONE NEW IN INOX
- MISCELATORE
- REALIZZATA IN POLIETILENE COLORATO IN MASSA
- ACCESSORI IN OTTONE ABS CROMATO
- ATTACCO DOCCIA POSTERIORE

SOLAR SHOWER

- NEW STAINLESS STEEL SHOWER HEAD
- MIXER
- MADE OF MASS COLORED HD POLYETHYLENE
- ACCESSORIES IN CHROMED BRASS AND CHROMED ABS
- REAR SHOWER ATTACHMENT

DOUCHE SOLAIRE

- POMME DE DOUCHE NEW INOX
- MITIGEUR
- FABRIQUÉE EN POLYÉTHYLÈNE COLORÉ DANS LA MASSE
- ACCESSOIRES EN LAITON CHROMÉ ET ABS
- RACCORD DE DOUCHE ARRIÈRE

DUCHA SOLAR

- CABEZA DE DUCHA NEW EN INOX
- MEZCLADOR
- REALIZADA EN POLIETILENO COLOREADO A GRANTEL EN MASE
- ACCESORIOS DE LATÓN CROMADO Y ABS CROMO
- ACCESORIO DE DUCHA TRASERA



COLORS

STANDARD COLORS RESIN

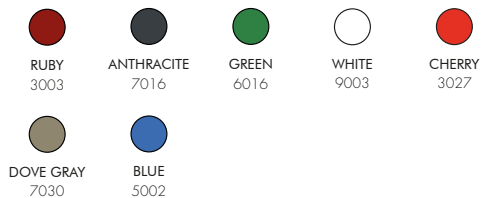

SPECIAL COLORS RESIN



*EXTRA FOR SPECIAL COLORS



BIG HAPPY FIVE F620

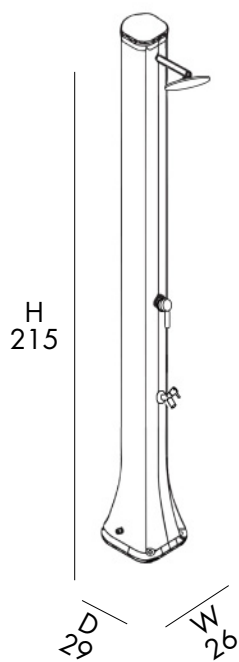

36 Lt



15,5 Kg



D 32 cm
H 221 cm
W 26 cm

DOCCIA SOLARE

- SOFFIONE NEW IN INOX
- MISCELATORE
- LAVAPIEDI
- REALIZZATA IN POLIETILENE COLORATO IN MASSA
- ACCESSORI IN OTTONE ABS CROMATO
- ATTACCO DOCCIA POSTERIORE

SOLAR SHOWER

- NEW STAINLESS STEEL SHOWER HEAD
- MIXER
- FOOTWASHER TAP
- MADE OF MASS COLORED HD POLYETHYLENE
- ACCESSORIES IN CHROMED BRASS AND CHROMED ABS
- REAR SHOWER ATTACHMENT

DOUCHE SOLAIRE

- POMME DE DOUCHE NEW INOX
- MITIGEUR
- RINCE PIEDS
- FABRIQUÉE EN POLYÉTHYLÈNE COLORÉ DANS LA MASSE
- ACCESSOIRES EN LAITON CHROMÉ ET ABS
- RACCORD DE DOUCHE ARRIÈRE

DUCHA SOLAR

- CABEZA DE DUCHA NEW EN INOX
- MEZCLADOR
- LAVAPIES
- REALIZADA EN POLIETILENO COLOREADO A GRANEL EN MASE
- ACCESORIOS DE LATÓN CROMADO Y ABS CROMO
- ACCESORIO DE DUCHA TRASERA



STANDARD COLORS RESIN

●
ANTHRACITE
7016

BIG HAPPY FIVE F620/90

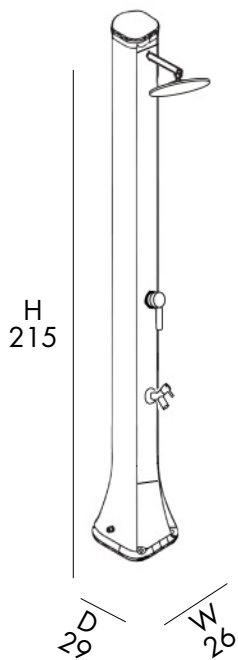

36 Lt



17,5 Kg



D 32 cm
H 221 cm
W 26 cm

DOCCIA SOLARE

- SOFFIONE NEW IN INOX
- MISCELATORE • LAVAPIEDI
- BANDA INOX
- REALIZZATA IN POLIETILENE COLORATO IN MASSA
- ACCESSORI IN OTTONE ABS CROMATO
- ATTACCO DOCCIA POSTERIORE

SOLAR SHOWER

- NEW STAINLESS STEEL SHOWER HEAD
- MIXER • FOOTWASHER TAP
- INOX BAND
- MADE OF MASS COLORED HD POLYETHYLENE
- ACCESSORIES IN CHROMED BRASS AND CHROMED ABS
- REAR SHOWER ATTACHMENT

DOUCHE SOLAIRE

- POMME DE DOUCHE NEW INOX
- MITIGEUR • RINCE PIEDS
- BANDE INOX
- FABRIQUÉE EN POLYÉTHYLÈNE COLORÉ DANS LA MASSE
- ACCESSOIRES EN LAITON CHROMÉ ET ABS
- RACCORD DE DOUCHE ARRIÈRE

DUCHA SOLAR

- CABEZA DE DUCHA NEW EN INOX
- MEZCLADOR • LAVAPIES
- BANDA DE ACERO INOX
- REALIZADA EN POLIETILENO COLOREADO A GRANUL EN MASE
- ACCESORIOS DE LATÓN CROMADO Y ABS CROMO
- ACCESORIO DE DUCHA TRASERA





**SOLAR
SHOWERS
ALLUMINIUM**



COLORS

STANDARD COLORS ALUMINIUM

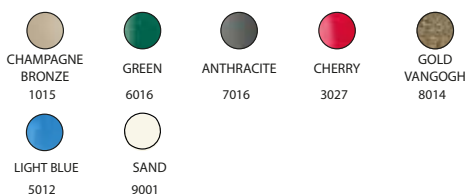

SPECIAL COLORS ALUMINIUM



*EXTRA FOR
SPECIAL COLORS

€

JOLLY A500

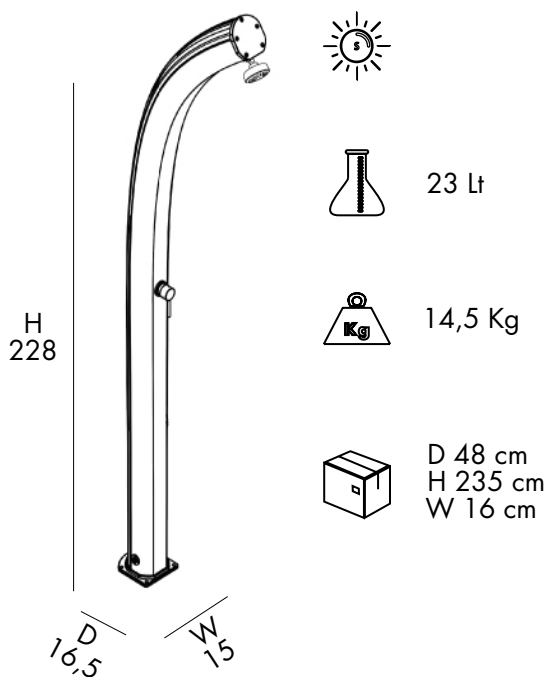

DOCCIA SOLARE

- SOFFIONE
- MISCELATORE
- REALIZZATA IN ALLUMINIO VERNICIATO A POLVERE
- ACCESSORI IN OTTONE ABS CROMATO
- ATTACCO DOCCIA LATERALE DESTRO

SOLAR SHOWER

- SHOWER HEAD
- MIXER
- MADE OF POWDER COATED ALUMINIUM
- ACCESSORIES IN CHROMED BRASS AND CHROMED ABS
- RIGHT SIDE SHOWER ATTACHMENT

DOUCHE SOLAIRE

- POMME DE DOUCHE
- MITIGEUR
- FABRIQUÉE EN ALUMINIUM PEINT EN POWDRE
- ACCESSOIRES EN LAITON CHROMÉ ET ABS
- RACCORD DE DOUCHE COTÉ DROIT

DUCHA SOLAR

- CABEZA DE DUCHA
- MEZCLADOR
- REALIZADA EN ALUMINIO PINTADO EN POLVO
- ACCESORIOS DE LATÓN CROMADO Y ABS CROMO
- ACCESORIO DE DUCHA DE LADO DERECHO



COLORS

STANDARD COLORS ALUMINIUM

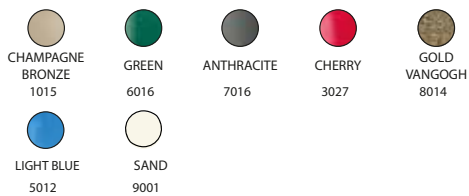

SPECIAL COLORS ALUMINIUM



*EXTRA FOR SPECIAL COLORS



JOLLY A520

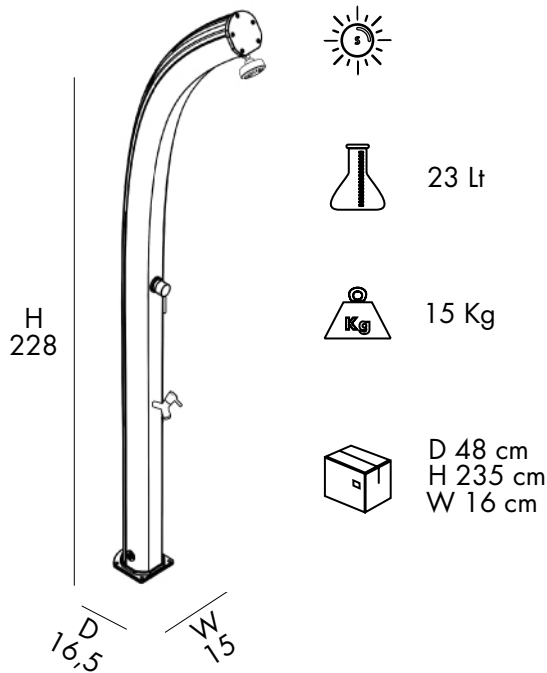

DOCCIA SOLARE

- SOFFIONE
- MISCELATORE
- LAVAPIEDI
- REALIZZATA IN ALLUMINIO VERNICIATO A POLVERE
- ACCESSORI IN OTTONE ABS CROMATO
- ATTACCO DOCCIA LATERALE DESTRO

SOLAR SHOWER

- SHOWER HEAD
- MIXER
- FOOTWASHER TAP
- MADE OF POWDER COATED ALUMINIUM
- ACCESSORIES IN CHROMED BRASS AND CHROMED ABS
- RIGHT SIDE SHOWER ATTACHMENT

DOUCHE SOLAIRE

- POMME DE DOUCHE
- MITIGEUR
- RINCE PIEDS
- FABRIQUÉE EN ALUMINIUM PEINT EN POUVRE
- ACCESSOIRES EN LAITON CHROMÉ ET ABS
- RACCORD DE DOUCHE COTÉ DROIT

DUCHA SOLAR

- CABEZA DE DUCHA
- MEZCLADOR
- LAVAPIES
- REALIZADA EN ALUMINIO PINTADO EN POLVO
- ACCESORIOS DE LATÓN CROMADO Y ABS CROMO
- ACCESORIO DE DUCHA DE LADO DERECHO



COLORS

STANDARD COLORS ALUMINIUM

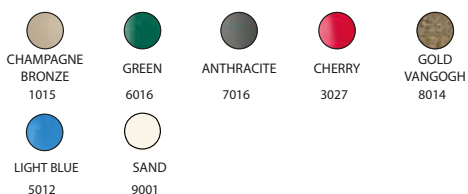

SPECIAL COLORS ALUMINIUM



*EXTRA FOR
SPECIAL COLORS

€

JOLLY S A600

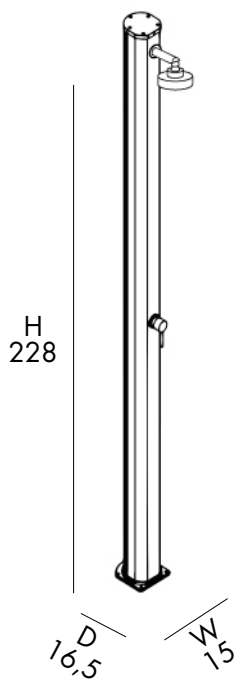

22 Lt



14 Kg



D 33 cm
H 234 cm
W 15 cm

DOCCIA SOLARE

- SOFFIONE
- MISCELATORE
- REALIZZATA IN ALLUMINIO VERNICIATO A POLVERE
- ACCESSORI IN OTTONE ABS CROMATO
- ATTACCO DOCCIA LATERALE DESTRO

SOLAR SHOWER

- SHOWER HEAD
- MIXER
- MADE OF POWDER COATED ALUMINIUM
- ACCESSORIES IN CHROMED BRASS AND CHROMED ABS
- RIGHT SIDE SHOWER ATTACHMENT

DOUCHE SOLAIRE

- POMME DE DOUCHE
- MITIGEUR
- FABRIQUÉE EN ALUMINIUM PEINT EN POUVRE
- ACCESSOIRES EN LAITON CHROMÉ ET ABS
- RACCORD DE DOUCHE COTÉ DROIT

DUCHA SOLAR

- CABEZA DE DUCHA
- MEZCLADOR
- REALIZADA EN ALUMINIO PINTADO EN POLVO
- ACCESORIOS DE LATÓN CROMADO Y ABS CROMO
- ACCESORIO DE DUCHA DE LADO DERECHO

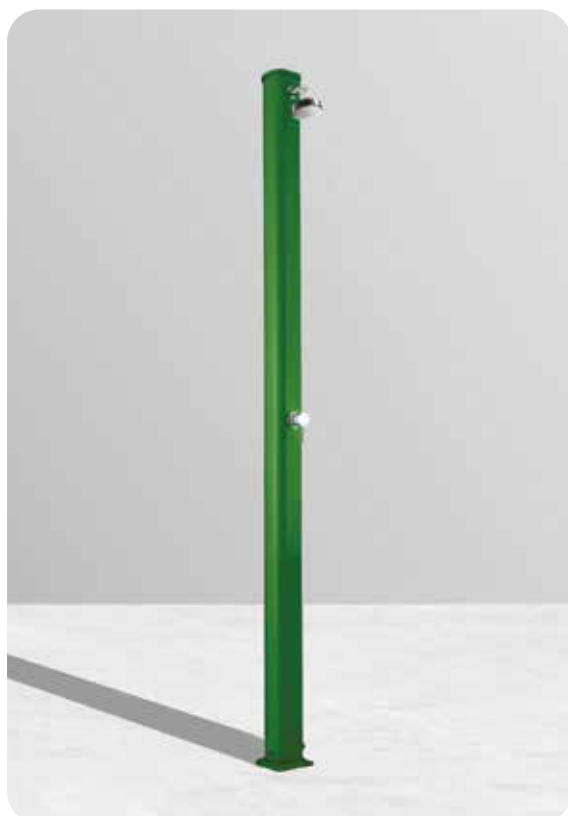

COLORS

STANDARD COLORS ALUMINIUM

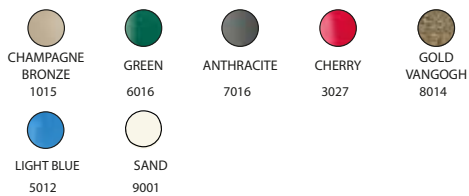

SPECIAL COLORS ALUMINIUM



*EXTRA FOR
SPECIAL COLORS

€

JOLLY S A620

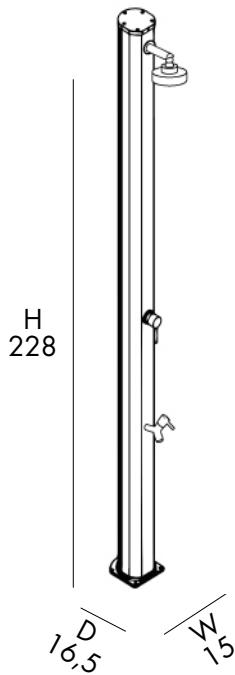

22 Lt



14,5 Kg



D 33 cm
H 234 cm
W 15 cm

DOCCIA SOLARE

- SOFFIONE
- MISCELATORE
- LAVAPIEDI
- REALIZZATA IN ALLUMINIO VERNICIATO A POLVERE
- ACCESSORI IN OTTONE ABS CROMATO
- ATTACCO DOCCIA LATERALE DESTRO



SOLAR SHOWER

- SHOWER HEAD
- MIXER
- FOOTWASHER TAP
- MADE OF POWDER COATED ALUMINIUM
- ACCESSORIES IN CHROMED BRASS AND CHROMED ABS
- RIGHT SIDE SHOWER ATTACHMENT

DOUCHE SOLAIRE

- POMME DE DOUCHE
- MITIGEUR
- RINCE PIEDS
- FABRIQUÉE EN ALUMINIUM PEINT EN POUVRE
- ACCESSOIRES EN LAITON CHROMÉ ET ABS
- RACCORD DE DOUCHE COTÉ DROIT



DUCHA SOLAR

- CABEZA DE DUCHA
- MEZCLADOR
- LAVAPIES
- REALIZADA EN ALUMINIO PINTADO EN POLVO
- ACCESORIOS DE LATÓN CROMADO Y ABS CROMO
- ACCESORIO DE DUCHA DE LADO DERECHO



COLORS

STANDARD COLORS ALUMINIUM

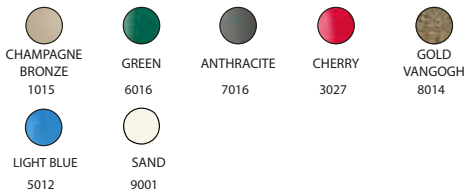

SPECIAL COLORS ALUMINIUM



*EXTRA FOR
SPECIAL COLORS

€

BIG JOLLY A300

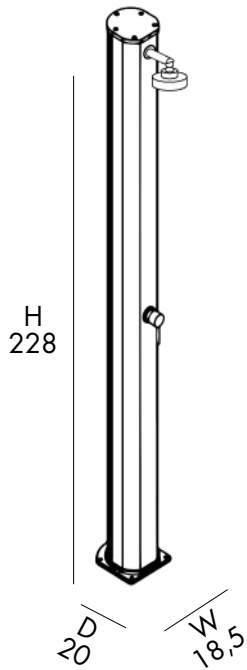

35 Lt



18,5 Kg



D 23 cm
H 234 cm
W 35 cm

DOCCIA SOLARE

- SOFFIONE
- MISCELATORE
- REALIZZATA IN ALLUMINIO VERNICIATO A POLVERE
- ACCESSORI IN OTTONE ABS CROMATO
- ATTACCO DOCCIA LATERALE DESTRO

SOLAR SHOWER

- SHOWER HEAD
- MIXER
- MADE OF POWDER COATED ALUMINIUM
- ACCESSORIES IN CHROMED BRASS AND CHROMED ABS
- RIGHT SIDE SHOWER ATTACHMENT

DOUCHE SOLAIRE

- POMME DE DOUCHE
- MITIGEUR
- FABRIQUÉE EN ALUMINIUM PEINT EN POUVRE
- ACCESSOIRES EN LAITON CHROMÉ ET ABS
- RACCORD DE DOUCHE COTÉ DROIT

DUCHA SOLAR

- CABEZA DE DUCHA
- MEZCLADOR
- REALIZADA EN ALUMINIO PINTADO EN POLVO
- ACCESORIOS DE LATÓN CROMADO Y ABS CROMO
- ACCESORIO DE DUCHA DE LADO DERECHO



COLORS

STANDARD COLORS ALUMINIUM

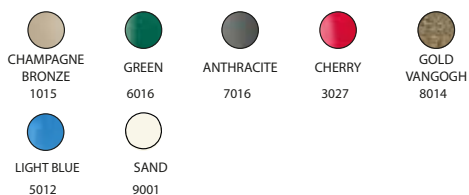

SPECIAL COLORS ALUMINIUM



*EXTRA FOR
SPECIAL COLORS

€

BIG JOLLY A320

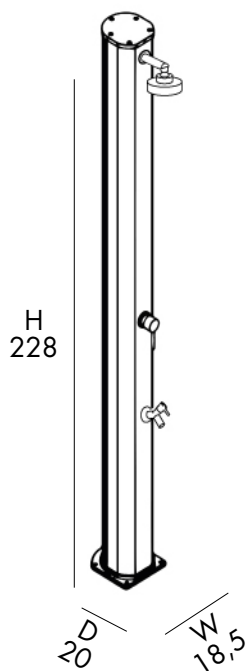

35 Lt



19 Kg



D 23 cm
H 234 cm
W 35 cm

DOCCIA SOLARE

- SOFFIONE
- MISCELATORE
- LAVAPIEDI
- REALIZZATA IN ALLUMINIO VERNICIATO A POLVERE
- ACCESSORI IN OTTONE ABS CROMATO
- ATTACCO DOCCIA LATERALE DESTRO



SOLAR SHOWER

- SHOWER HEAD
- MIXER
- FOOTWASHER TAP
- MADE OF POWDER COATED ALUMINIUM
- ACCESSORIES IN CHROMED BRASS AND CHROMED ABS
- RIGHT SIDE SHOWER ATTACHMENT

DOUCHE SOLAIRE

- POMME DE DOUCHE
- MITIGEUR
- RINCE PIEDS
- FABRIQUÉE EN ALUMINIUM PEINT EN POUDRE
- ACCESSOIRES EN LAITON CHROMÉ ET ABS
- RACCORD DE DOUCHE COTÉ DROIT



DUCHA SOLAR

- CABEZA DE DUCHA
- MEZCLADOR
- LAVAPIES
- REALIZADA EN ALUMINIO PINTADO EN POLVO
- ACCESORIOS DE LATÓN CROMADO Y ABS CROMO
- ACCESORIO DE DUCHA DE LADO DERECHO



COLORS

STANDARD COLORS ALUMINIUM

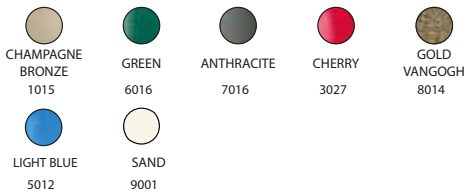

SPECIAL COLORS ALUMINIUM



*EXTRA FOR INOX BAND	€
*EXTRA FOR SPECIAL COLORS	€

SPRING A100

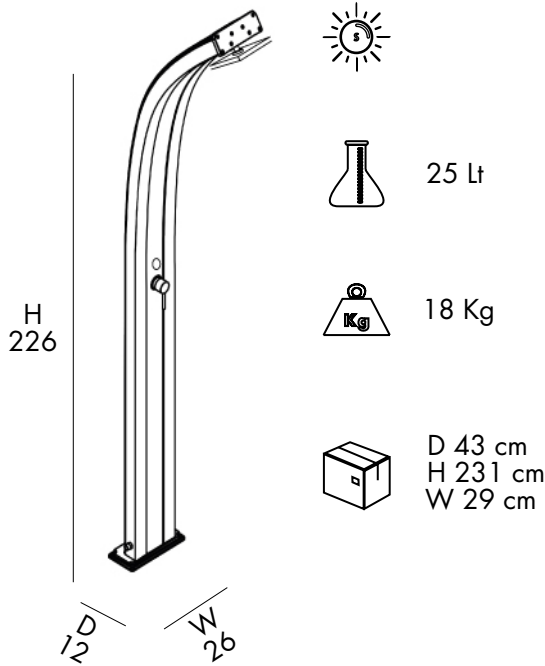

DOCCIA SOLARE

- SOFFIONE
- MISCELATORE
- REALIZZATA IN ALLUMINIO VERNICIATO A POLVERE
- ACCESSORI IN OTTONE ABS CROMATO
- ATTACCO DOCCIA POSTERIORE

SOLAR SHOWER

- SHOWER HEAD
- MIXER
- MADE OF POWDER COATED ALUMINIUM
- ACCESSORIES IN CHROMED BRASS AND CHROMED ABS
- REAR SHOWER ATTACHMENT

DOUCHE SOLAIRE

- POMME DE DOUCHE
- MITIGEUR
- FABRIQUÉE EN ALUMINIUM PEINT EN POUVRE
- ACCESSOIRES EN LAITON CHROMÉ ET ABS
- RACCORD DE DOUCHE ARRIÈRE

DUCHA SOLAR

- CABEZA DE DUCHA
- MEZCLADOR
- REALIZADA EN ALUMINIO PINTADO EN POLVO
- ACCESORIOS DE LATÓN CROMADO Y ABS CROMO
- ACCESORIO DE DUCHA TRASERA



COLORS

STANDARD COLORS ALUMINIUM

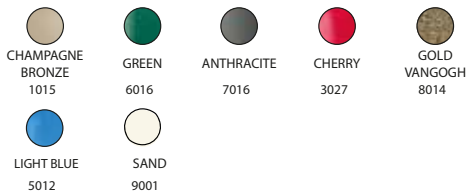

SPECIAL COLORS ALUMINIUM



*EXTRA FOR INOX BAND	€
*EXTRA FOR SPECIAL COLORS	€

SPRING A120

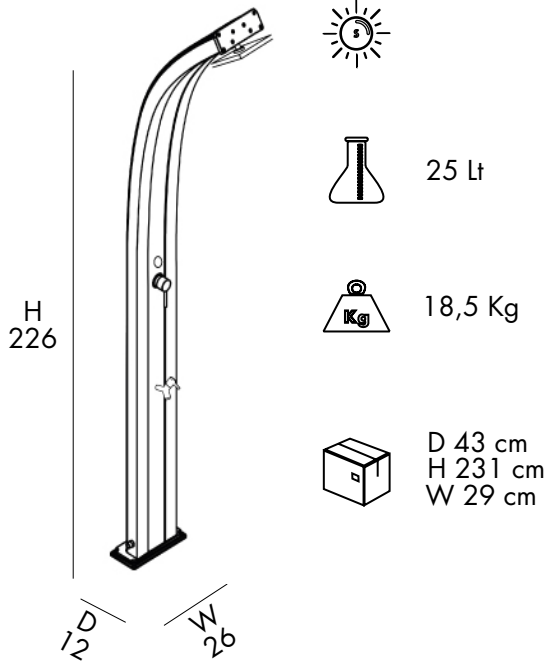

DOCCIA SOLARE

- SOFFIONE
- MISCELATORE
- LAVAPIEDI
- REALIZZATA IN ALLUMINIO VERNICIATO A POLVERE
- ACCESSORI IN OTTONE ABS CROMATO
- ATTACCO DOCCIA POSTERIORE

SOLAR SHOWER

- SHOWER HEAD
- MIXER
- FOOTWASHER TAP
- MADE OF POWDER COATED ALUMINIUM
- ACCESSORIES IN CHROMED BRASS AND CHROMED ABS
- REAR SHOWER ATTACHMENT

DOUCHE SOLAIRE

- POMME DE DOUCHE
- MITIGEUR
- RINCE PIEDS
- FABRIQUÉE EN ALUMINIUM PEINT EN POUVRE
- ACCESSOIRES EN LAITON CHROMÉ ET ABS
- RACCORD DE DOUCHE ARRIÈRE

DUCHA SOLAR

- CABEZA DE DUCHA
- MEZCLADOR
- LAVAPIES
- REALIZADA EN ALUMINIO PINTADO EN POLVO
- ACCESORIOS DE LATÓN CROMADO Y ABS CROMO
- ACCESORIO DE DUCHA TRASERA



COLORS

STANDARD COLORS ALUMINIUM

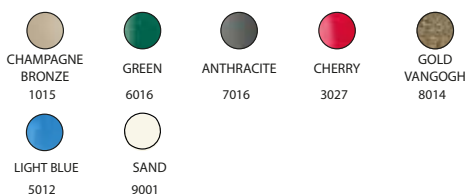

SPECIAL COLORS ALUMINIUM



*EXTRA FOR INOX BAND	€
*EXTRA FOR SPECIAL COLORS	€

SPRING S A200

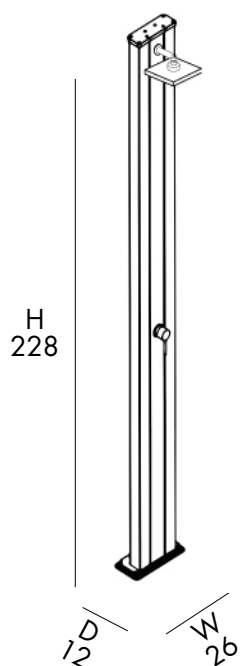

25 Lt



17,5 Kg



D 28 cm
H 232 cm
W 24 cm

DOCCIA SOLARE

- SOFFIONE
- MISCELATORE
- REALIZZATA IN ALLUMINIO VERNICIATO A POLVERE
- ACCESSORI IN OTTONE ABS CROMATO
- ATTACCO DOCCIA POSTERIORE

SOLAR SHOWER

- SHOWER HEAD
- MIXER
- MADE OF POWDER COATED ALUMINIUM
- ACCESSORIES IN CHROMED BRASS AND CHROMED ABS
- REAR SHOWER ATTACHMENT

DOUCHE SOLAIRE

- POMME DE DOUCHE
- MITIGEUR
- FABRIQUÉE EN ALUMINIUM PEINT EN POUVRE
- ACCESSOIRES EN LAITON CHROMÉ ET ABS
- RACCORD DE DOUCHE ARRIÈRE

DUCHA SOLAR

- CABEZA DE DUCHA
- MEZCLADOR
- REALIZADA EN ALUMINIO PINTADO EN POLVO
- ACCESORIOS DE LATÓN CROMADO Y ABS CROMO
- ACCESORIO DE DUCHA TRASERA



COLORS

STANDARD COLORS ALUMINIUM

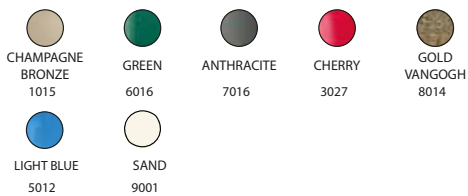

SPECIAL COLORS ALUMINIUM



*EXTRA FOR INOX BAND	€
*EXTRA FOR SPECIAL COLORS	€

SPRING S A220

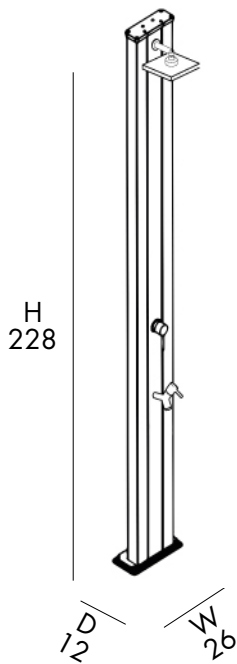

25 Lt



18 Kg



D 28 cm
H 232 cm
W 24 cm

DOCCIA SOLARE

- SOFFIONE
- MISCELATORE
- LAVAPIEDI
- REALIZZATA IN ALLUMINIO VERNICIATO A POLVERE
- ACCESSORI IN OTTONE ABS CROMATO
- ATTACCO DOCCIA POSTERIORE

SOLAR SHOWER

- SHOWER HEAD
- MIXER
- FOOTWASHER TAP
- MADE OF POWDER COATED ALUMINIUM
- ACCESSORIES IN CHROMED BRASS AND CHROMED ABS
- REAR SHOWER ATTACHMENT

DOUCHE SOLAIRE

- POMME DE DOUCHE
- MITIGEUR
- RINCE PIEDS
- FABRIQUÉE EN ALUMINIUM PEINT EN POUVRE
- ACCESSOIRES EN LAITON CHROMÉ ET ABS
- RACCORD DE DOUCHE ARRIÈRE

DUCHA SOLAR

- CABEZA DE DUCHA
- MEZCLADOR
- LAVAPIES
- REALIZADA EN ALUMINIO PINTADO EN POLVO
- ACCESORIOS DE LATÓN CROMADO Y ABS CROMO
- ACCESORIO DE DUCHA TRASERA



COLORS

STANDARD COLORS ALUMINIUM

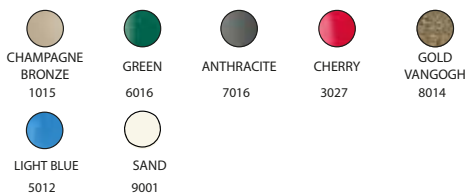

SPECIAL COLORS ALUMINIUM



*EXTRA FOR INOX BAND	€
*EXTRA FOR SPECIAL COLORS	€

DADA D300

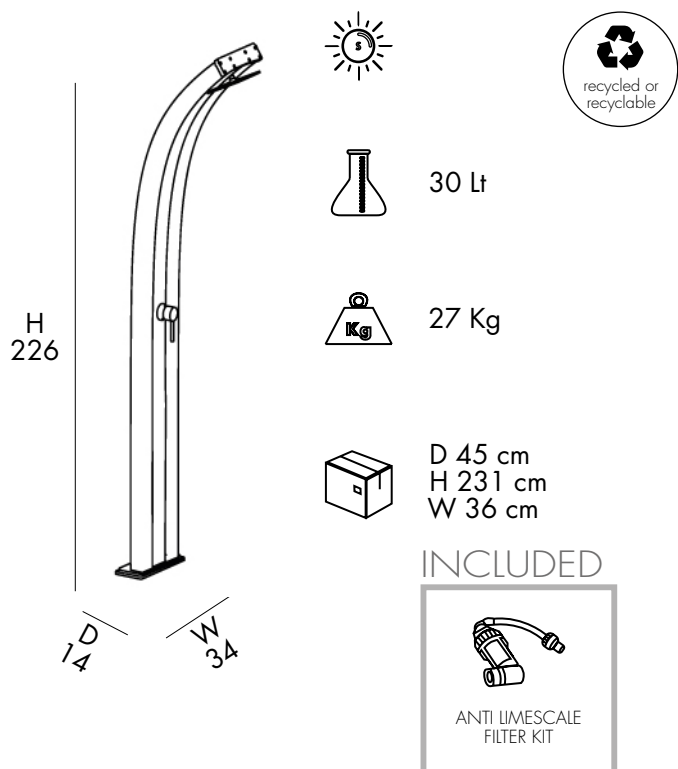

DOCCIA SOLARE

- SOFFIONE
- MISCELATORE
- KIT FILTRO ANTICALCARE
- REALIZZATA IN ALLUMINIO VERNICIATO A POLVERE
- ACCESSORI IN OTTONE ABS CROMATO
- ATTACCO DOCCIA POSTERIORE

SOLAR SHOWER

- SHOWER HEAD
- MIXER
- ANTI LIMESCALE FILTER KIT
- MADE OF POWDER COATED ALUMINIUM
- ACCESSORIES IN CHROMED BRASS AND CHROMED ABS
- REAR SHOWER ATTACHMENT

DOUCHE SOLAIRE

- POMME DE DOUCHE
- MITIGEUR
- KIT FILTRE ANTICALCAIRE
- FABRIQUÉE EN ALUMINIUM PEINT EN POUVRE
- ACCESSOIRES EN LAITON CHROMÉ ET ABS
- RACCORD DE DOUCHE ARRIÈRE

DUCHA SOLAR

- CABEZA DE DUCHA
- MEZCLADOR
- KIT DE FILTRO ANTICAL
- REALIZADA EN ALUMINIO PINTADO EN POLVO
- ACCESORIOS DE LATÓN CROMADO Y ABS CROMO
- ACCESORIO DE DUCHA TRASERA



COLORS

STANDARD COLORS ALUMINIUM

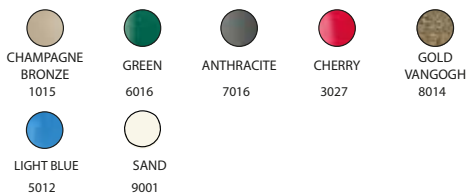

SPECIAL COLORS ALUMINIUM



*EXTRA FOR INOX BAND	€
*EXTRA FOR SPECIAL COLORS	€

DADA D320

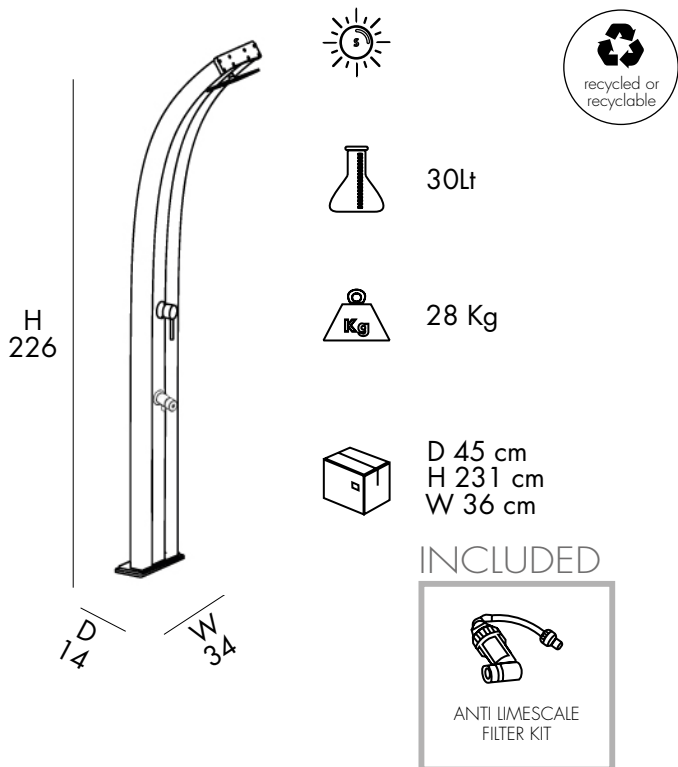

DOCCIA SOLARE

- SOFFIONE • MISCELATORE
- LAVAPIEDI TEMPORIZZATO
- KIT FILTRO ANTICALCARE
- REALIZZATA IN ALLUMINIO VERNICIATO A POLVERE
- ACCESSORI IN OTTONE ABS CROMATO
- ATTACCO DOCCIA POSTERIORE

SOLAR SHOWER

- SHOWER HEAD • MIXER
- TEMPORIZED FOOTWASHER TAP
- ANTI LIMESCALE FILTER KIT
- MADE OF POWDER COATED ALUMINIUM
- ACCESSORIES IN CHROMED BRASS AND CHROMED ABS
- REAR SHOWER ATTACHMENT

DOUCHE SOLAIRE

- POMME DE DOUCHE • MITIGEUR
- RINCE PIEDS TEMPORISÉ
- KIT FILTRE ANTICALCAIRE
- FABRIQUÉE EN ALUMINIUM PEINT EN POUDRE
- ACCESSOIRES EN LAITON CHROMÉ ET ABS
- RACCORD DE DOUCHE ARRIÈRE

DUCHA SOLAR

- CABEZA DE DUCHA • MEZCLADOR
- KIT DE FILTRO ANTICAL
- LAVAPIES TEMPORIZADO
- REALIZADA EN ALUMINIO PINTADO EN POLVO
- ACCESORIOS DE LATÓN CROMADO Y ABS CROMO
- ACCESORIO DE DUCHA TRASERA



COLORS

STANDARD COLORS ALUMINIUM

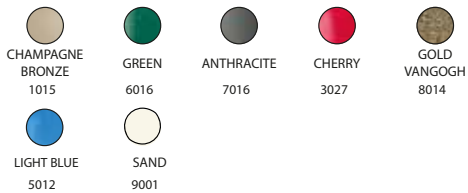

SPECIAL COLORS ALUMINIUM



*EXTRA FOR INOX BAND	€
*EXTRA FOR SPECIAL COLORS	€

DADA D330

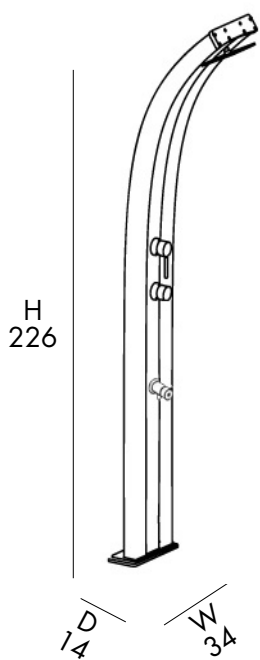

30 Lt



29 Kg



D 45 cm
H 231 cm
W 36 cm

INCLUDED



ANTI LIMESCALE
FILTER KIT



DOCCIA SOLARE

- SOFFIONE • MISCELATORE • KIT FILTRO ANTICALCARE
- LAVAPIEDI TEMPORIZZATO • TEMPORIZZATORE
- REALIZZATA IN ALLUMINIO VERNICIATO A POLVERE
- ACCESSORI IN OTTONE ABS CROMATO
- ATTACCO DOCCIA POSTERIORE

SOLAR SHOWER

- SHOWER HEAD • MIXER • ANTI LIMESCALE FILTER KIT
- TEMPORIZED FOOTWASHER • TEMPORIZED BUTTON
- MADE OF POWDER COATED ALUMINIUM
- ACCESSORIES IN CHROMED BRASS AND CHROMED ABS
- REAR SHOWER ATTACHMENT

DOUCHE SOLAIRE

- POMME DE DOUCHE • MITIGEUR • KIT FILTRE ANTICALCAIRE
- RINCE PIEDS TEMPORISÉ • BOUTON TEMPORISÉ
- FABRIQUÉE EN ALUMINIUM PEINT EN POUDRE
- ACCESSOIRES EN LAITON CHROMÉ ET ABS
- RACCORD DE DOUCHE ARRIÈRE

DUCHA SOLAR

- CABEZA DE DUCHA • MEZCLADOR • KIT DE FILTRO ANTICAL
- LAVAPIES TEMPORIZADO • BOTÓN TEMPORIZADO
- REALIZADA EN ALUMINIO PINTADO EN POLVO
- ACCESORIOS DE LATÓN CROMADO Y ABS CROMO
- ACCESORIO DE DUCHA TRASERA



COLORS

STANDARD COLORS ALUMINIUM

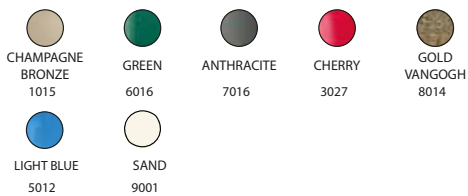

SPECIAL COLORS ALUMINIUM



*EXTRA FOR INOX BAND	€
*EXTRA FOR SPECIAL COLORS	€

DADA D340

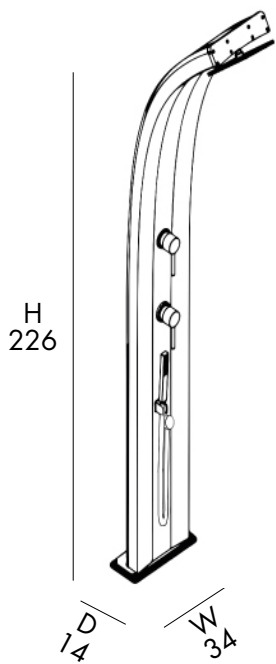

30 Lt



29 Kg



D 45 cm
H 231 cm
W 36 cm

INCLUDED



ANTI LIMESCALE
FILTER KIT



DEVIATORE
DIVERTER



DOCCIA SOLARE

- SOFFIONE • MISCELATORE • DOCCETTA • DEVIATORE
- KIT FILTRO ANTICALCARE
- REALIZZATA IN ALLUMINIO VERNICIATO A POLVERE
- ACCESSORI IN OTTONE ABS CROMATO
- ATTACCO DOCCIA POSTERIORE

SOLAR SHOWER

- SHOWER HEAD • MIXER • HAND SHOWER • DIVERTER
- ANTI LIMESCALE FILTER KIT
- MADE OF POWDER COATED ALUMINIUM
- ACCESSORIES IN CHROMED BRASS AND CHROMED ABS
- REAR SHOWER ATTACHMENT

DOUCHE SOLAIRE

- POMME DE DOUCHE • MITIGEUR • DOUCHETTE
- DÉVIATEUR
- KIT FILTRE ANTICALCAIRE
- FABRIQUÉE EN ALUMINIUM PEINT EN POUVRE
- ACCESSOIRES EN LAITON CHROMÉ ET ABS
- RACCORD DE DOUCHE ARRIÈRE

DUCHA SOLAR

- CABEZA DE DUCHA • MEZCLADOR • DUCHA MOVIL
- DEVIATOR
- KIT DE FILTRO ANTICAL
- REALIZADA EN ALUMINIO PINTADO EN POLVO
- ACCESORIOS DE LATÓN CROMADO Y ABS CROMO
- ACCESORIO DE DUCHA TRASERA

COLORS

STANDARD COLORS ALUMINIUM

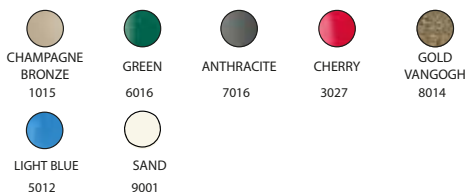

SPECIAL COLORS ALUMINIUM



*EXTRA FOR INOX BAND	€
*EXTRA FOR SPECIAL COLORS	€

DADA D350

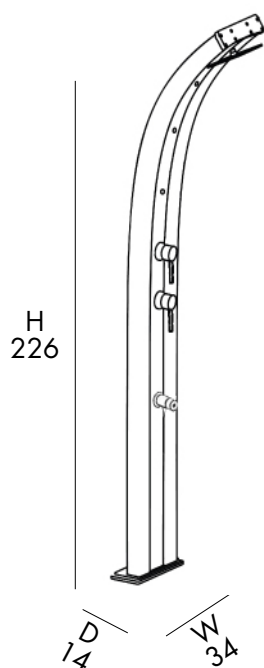

30 Lt



29 Kg



D 45 cm
H 231 cm
W 36 cm

INCLUDED



ANTI LIMESCALE
FILTER KIT



DEVIATORE
DIVERTER



DOCCIA SOLARE

- SOFFIONE • MISCELATORE • LAVAPIEDI TEMPORIZZATO
- DEVIATORE • 3 NEBULIZZATORI • KIT FILTRO ANTICALCARE
- REALIZZATA IN ALLUMINIO VERNICIATO A POLVERE
- ACCESSORI IN OTTONE ABS CROMATO
- ATTACCO DOCCIA POSTERIORE

SOLAR SHOWER

- SHOWER HEAD • MIXER • TEMPORIZED FOOTWASHER TAP
- DIVERTER • 3 NEBULIZER • ANTI LIMESCALE FILTER KIT
- MADE OF POWDER COATED ALUMINIUM
- ACCESSORIES IN CHROMED BRASS AND CHROMED ABS
- REAR SHOWER ATTACHMENT

DOUCHE SOLAIRE

- POMME DE DOUCHE • MITIGEUR • RINCE PIEDS TEMP.
- DÉVIATEUR • 3 NÉBULISEUR • KIT FILTRE ANTICALCAIRE
- FABRIQUÉE EN ALUMINIUM PEINT EN POUDRE
- ACCESSOIRES EN LAITON CHROMÉ ET ABS
- RACCORDE DOUCHE ARRIÈRE

DUCHA SOLAR

- CABEZA DE DUCHA • MEZCLADOR • LAVAPIES TEMP
- DEVIATOR • 3 NEBULIZADORES • KIT DE FILTRO ANTICAL
- REALIZADA EN ALUMINIO PINTADO EN POLVO
- ACCESORIOS DE LATÓN CROMADO Y ABS CROMO
- ACCESORIO DE DUCHA TRASERA

COLORS

STANDARD COLORS ALUMINIUM

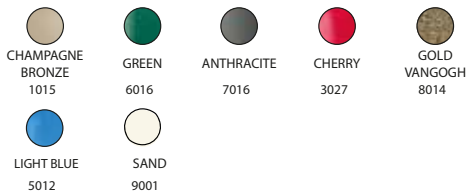

SPECIAL COLORS ALUMINIUM



*EXTRA FOR INOX BAND	€
*EXTRA FOR SPECIAL COLORS	€

DADA S D420

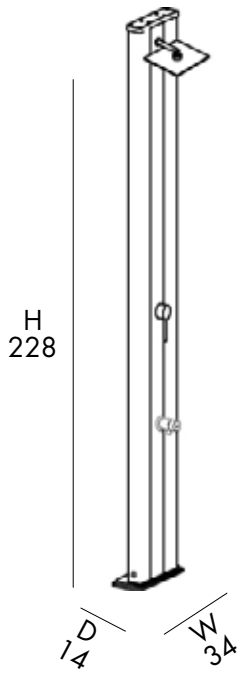

30 Lt



27,5 Kg



D 24 cm
H 231 cm
W 36 cm

INCLUDED



ANTI LIMESCALE
FILTER KIT



DOCCIA SOLARE

- SOFFIONE • MISCELATORE • LAVAPIEDI TEMPORIZZATO
- KIT FILTRO ANTICALCARE
- REALIZZATA IN ALLUMINIO VERNICIATO A POLVERE
- ACCESSORI IN OTTONE ABS CROMATO
- ATTACCO DOCCIA POSTERIORE

SOLAR SHOWER

- SHOWER HEAD • MIXER • TEMPORIZED FOOTWASHER TAP
- ANTI LIMESCALE FILTER KIT
- MADE OF POWDER COATED ALUMINIUM
- ACCESSORIES IN CHROMED BRASS AND CHROMED ABS
- REAR SHOWER ATTACHMENT

DOUCHE SOLAIRE

- POMME DE DOUCHE • MITIGEUR • RINCEPIEDS TEMP.
- KIT FILTRE ANTICALCAIRE
- FABRIQUÉE EN ALUMINIUM PEINT EN POUVRE
- ACCESSOIRES EN LAITON CHROMÉ ET ABS
- RACCORD DE DOUCHE ARRIÈRE

DUCHA SOLAR

- CABEZA DE DUCHA • MEZCLADOR • LAVAPIES TEMP.
- KIT DE FILTRO ANTICAL
- REALIZADA EN ALUMINIO PINTADO EN POLVO
- ACCESORIOS DE LATÓN CROMADO Y ABS CROMO
- ACCESORIO DE DUCHA TRASERA



COLORS

STANDARD COLORS ALUMINIUM

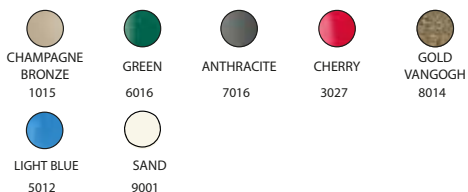

SPECIAL COLORS ALUMINIUM



*EXTRA FOR INOX BAND	€
*EXTRA FOR SPECIAL COLORS	€

DADA S D440

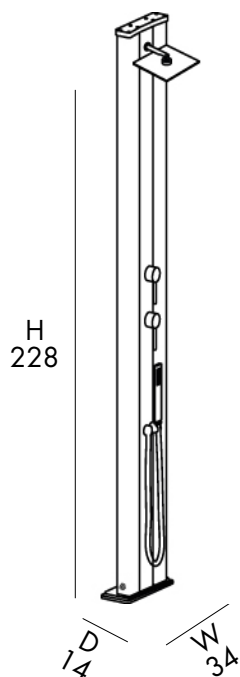

30 Lt



28 Kg



D 24 cm
H 231 cm
W 36 cm

INCLUDED



ANTI LIMESCALE
FILTER KIT



DEVIATORE
DIVERTER



DOCCIA SOLARE

- SOFFIONE • MISCELATORE • DOCCETTA • DEVIATORE
- KIT FILTRO ANTICALCARE
- REALIZZATA IN ALLUMINIO VERNICIATO A POLVERE
- ACCESSORI IN OTTONE ABS CROMATO
- ATTACCO DOCCIA POSTERIORE

SOLAR SHOWER

- SHOWER HEAD • MIXER • HAND SHOWER • DIVERTER
- ANTI LIMESCALE FILTER KIT
- MADE OF POWDER COATED ALUMINIUM
- ACCESSORIES IN CHROMED BRASS AND CHROMED ABS
- REAR SHOWER ATTACHMENT

DOUCHE SOLAIRE

- POMME DE DOUCHE • MITIGEUR • DOUCHETTE
- DÉVIATEUR
- KIT FILTRE ANTICALCAIRE
- FABRIQUÉE EN ALUMINIUM PEINT EN POUVRE
- ACCESSOIRES EN LAITON CHROMÉ ET ABS
- RACCORD DE DOUCHE ARRIÈRE

DUCHA SOLAR

- CABEZA DE DUCHA • MEZCLADOR • DUCHA MOVIL
- DEVIATOR
- KIT DE FILTRO ANTICAL
- REALIZADA EN ALUMINIO PINTADO EN POLVO
- ACCESORIOS DE LATÓN CROMADO Y ABS CROMO
- ACCESORIO DE DUCHA TRASERA

COLORS

STANDARD COLORS ALUMINIUM

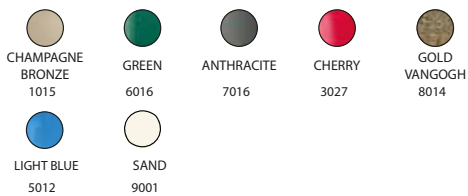

SPECIAL COLORS ALUMINIUM



*EXTRA FOR INOX BAND	€
*EXTRA FOR SPECIAL COLORS	€

DADA S D450

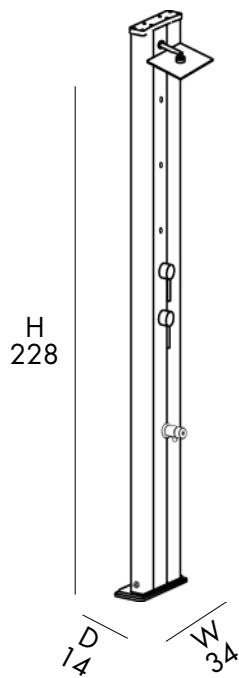

30 Lt



28 Kg



D 24 cm
H 231 cm
W 36 cm

INCLUDED



ANTI LIMESCALE
FILTER KIT



DEVIATORE
DIVERTER



DOCCIA SOLARE

- SOFFIONE • MISCELATORE • LAVAPIEDI TEMPORIZZATO
- DEVIATORE • 3 NEBULIZZATORI • KIT FILTRO ANTICALCARE
- REALIZZATA IN ALLUMINIO VERNICIATO A POLVERE
- ACCESSORI IN OTTONE ABS CROMATO
- ATTACCO DOCCIA POSTERIORE

SOLAR SHOWER

- SHOWER HEAD • MIXER • TEMPORIZED FOOTWASHER TAP
- DIVERTER • 3 NEBULIZERS • ANTI LIMESCALE FILTER KIT
- MADE OF POWDER COATED ALUMINIUM
- ACCESSORIES IN CHROMED BRASS AND CHROMED ABS
- REAR SHOWER ATTACHMENT

DOUCHE SOLAIRE

- POMME DE DOUCHE • MITIGEUR • RINCE PIEDS TEMPORISÉ
- DÉVIATEUR • 3 NÉBULISEURS • KIT FILTRE ANTICALCAIRE
- FABRIQUÉE EN ALUMINIUM PEINT EN POUVRE
- ACCESSOIRES EN LAITON CHROMÉ ET ABS
- RACCORD DE DOUCHE ARRIÈRE

DUCHA SOLAR

- CABEZA DE DUCHA • MEZCLADOR • LAVAPIES TEMPORIZADO
- DEVIATOR • 3 NEBULIZADORES • KIT DE FILTYO ANTICAL
- REALIZADA EN ALUMINIO PINTADO EN POLVO
- ACCESORIOS DE LATÓN CROMADO Y ABS CROMO
- ACCESORIO DE DUCHA TRASERA



COLORS

STANDARD COLORS ALUMINIUM



SAND
9001



ANTHRACITE
7016

ENERGY PRO A920

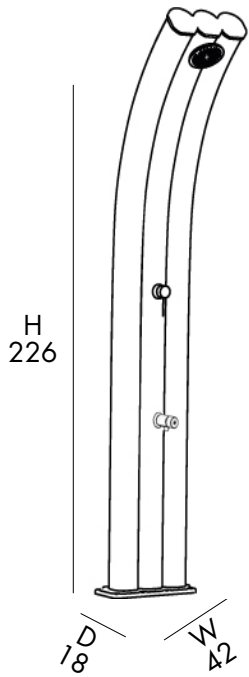

69 Lt



45 Kg



D 47 cm
H 235 cm
W 48 cm

INCLUDED



ANTI LIMESCALE
FILTER KIT

DOCCIA SOLARE

- SOFFIONE • MISCELATORE • LAVAPIEDI TEMPORIZZATO
- KIT FILTRO ANTICALCARE
- REALIZZATA IN ALLUMINIO VERNICIATO A POLVERE
- ACCESSORI IN OTTONE ABS CROMATO
- ATTACCO DOCCIA LATERALE DESTRO

SOLAR SHOWER

- SHOWER HEAD • MIXER • TEMPORIZED FOOTWASHER TAP
- ANTI LIMESCALE FILTER KIT
- MADE OF POWDER COATED ALUMINIUM
- ACCESSORIES IN CHROMED BRASS AND CHROMED ABS
- RIGHT SIDE SHOWER ATTACHMENT

DOUCHE SOLAIRE

- POMME DE DOUCHE • MITIGEUR • RINCE PIEDS TEMPORISÉ
- KIT FILTRE ANTICALCAIRE
- FABRIQUÉE EN ALUMINIUM PEINT EN POUVRE
- ACCESSOIRES EN LAITON CHROMÉ ET ABS
- ACCESSOIRE DE DOUCHE COTÉ DROIT

DUCHA SOLAR

- CABEZA DE DUCHA • MEZCLADOR • LAVAPIES TEMPORIZADO
- KIT DE FILTRO ANTICAL
- REALIZADA EN ALUMINIO PINTADO EN POLVO
- ACCESORIOS DE LATÓN CROMADO Y ABS CROMO
- ACCESORIO DE DUCHA DEL LADO DERECHO



STANDARD COLORS ALUMINIUM



SAND
9001



ANTHRACITE
7016

ENERGY PRO A930

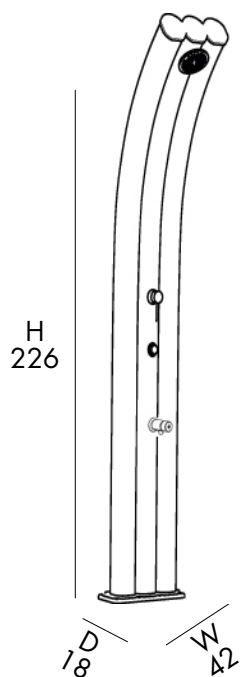

69 Lt



46 Kg



D 47 cm
H 235 cm
W 48 cm

INCLUDED



ANTI LIMESCALE
FILTER KIT

DOCCIA SOLARE

- SOFFIONE • MISCELATORE • LAVAPIEDI TEMPORIZZATO
- TEMPORIZZATORE
- KIT FILTRO ANTICALCARE
- REALIZZATA IN ALLUMINIO VERNICIATO A POLVERE
- ACCESSORI IN OTTONE ABS CROMATO
- ATTACCO DOCCIA LATERALE DESTRO



SOLAR SHOWER

- SHOWER HEAD • MIXER • TEMPORIZED FOOTWASHER TAP
- TEMPORIZED BUTTON
- ANTI LIMESCALE FILTER KIT
- MADE OF POWDER COATED ALUMINIUM
- ACCESSORIES IN CHROMED BRASS AND CHROMED ABS
- RIGHT SIDE SHOWER ATTACHMENT

DOUCHE SOLAIRE

- POMME DE DOUCHE • MITIGEUR • RINCE PIEDS TEMPORISÉ
- BOUTON TEMPORISÉ
- KIT FILTRE ANTICALCAIRE
- FABRIQUÉE EN ALUMINIUM PEINT EN POUDRE
- ACCESSOIRES EN LAITON CHROMÉ ET ABS
- ACCESSOIRE DE DOUCHE COTÉ DROIT



DUCHA SOLAR

- CABEZA DE DUCHA • MEZCLADOR • LAVAPIES TEMPORIZADO
- TEMPORIZADOR
- KIT DE FILTRO ANTICAL
- REALIZADA EN ALUMINIO PINTADO EN POLVO
- ACCESORIOS DE LATÓN CROMADO Y ABS CROMO
- ACCESORIO DE DUCHA DEL LADO DERECHO





**TRADITIONAL
SHOWERS**

RESIN



COLORS

STANDARD COLORS RESIN

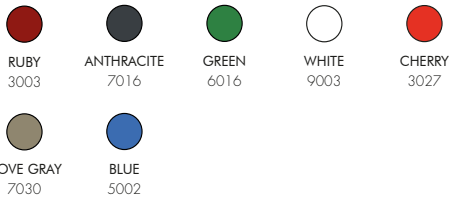

SPECIAL COLORS RESIN



*EXTRA FOR SPECIAL COLORS



FUNNY YIN T105

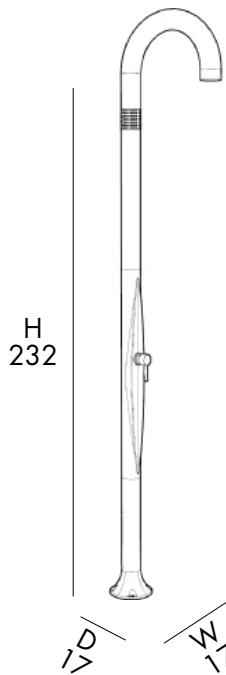

9 Kg



D 48 cm
H 194 cm
W 21 cm



DOCCIA TRADIZIONALE

- SOFFIONE
- MISCELATORE
- REALIZZATA IN POLIETILENE COLORATO IN MASSA
- ACCESSORI IN OTTONE ABS CROMATO
- ATTACCO DOCCIA STANDARD A PAVIMENTO, SU RICHIESTA LATERALE

TRADITIONAL SHOWER

- SHOWER HEAD
- MIXER
- MADE OF MASS COLORED HD POLYETHYLENE
- ACCESSORIES IN CHROMED BRASS AND CHROMED ABS
- SHOWER ATTACHMENT AT THE BASE, LATERAL ON REQUEST

DOUCHE TRADITIONNELLE

- POMME DE DOUCHE
- MITIGEUR
- FABRIQUÉE EN POLYÉTHYLÈNE COLORÉ DANS LA MASSE
- ACCESSOIRES EN LAITON CHROMÉ ET ABS
- RACCORDEMENT DOUCHE AU SOL, LATERAL SUR DEMANDE

DUCHA TRADITIONAL

- CABEZA DE DUCHA
- MEZCLADOR
- REALIZADA EN POLIETILENO COLOREADO A GRANEL EN MASE
- ACCESORIOS DE LATÓN CROMADO Y ABS CROMO
- CONEXIÓN DE DUCHA EN EL SUELO, LATERAL BAJO PEDIDO

COLORS

STANDARD COLORS RESIN

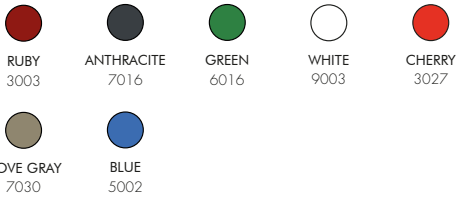

SPECIAL COLORS RESIN



*EXTRA FOR SPECIAL COLORS



FUNNY YIN T305

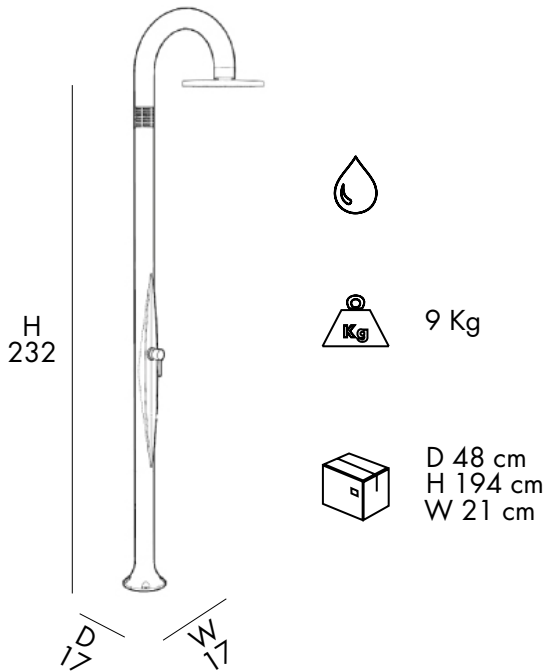

DOCCIA TRADIZIONALE

- SOFFIONE 250mm
- MISCELATORE
- REALIZZATA IN POLIETILENE COLORATO IN MASSA
- ACCESSORI IN OTTONE ABS CROMATO
- ATTACCO DOCCIA STANDARD A PAVIMENTO, SU RICHIESTA LATERALE

TRADITIONAL SHOWER

- SHOWER HEAD 250mm
- MIXER
- MADE OF MASS COLORED HD POLYETHYLENE
- ACCESSORIES IN CHROMED BRASS AND CHROMED ABS
- SHOWER ATTACHMENT AT THE BASE, LATERAL ON REQUEST

DOUCHE TRADITIONNELLE

- POMME DE DOUCHE 250mm
- MITIGEUR
- FABRIQUÉE EN POLYÉTHYLÈNE COLORÉ DANS LA MASSE
- ACCESSOIRES EN LAITON CHROMÉ ET ABS
- RACCORDEMENT DOUCHE AU SOL, LATERAL SUR DEMANDE

DUCHA TRADITIONAL

- CABEZA DE DUCHA 250mm
- MEZCLADOR
- REALIZADA EN POLIETILENO COLOREADO A GRANDEL EN MASE
- ACCESORIOS DE LATÓN CROMADO Y ABS CROMO
- CONEXIÓN DE DUCHA EN EL SUELO, LATERAL BAJO PEDIDO



COLORS

STANDARD COLORS RESIN

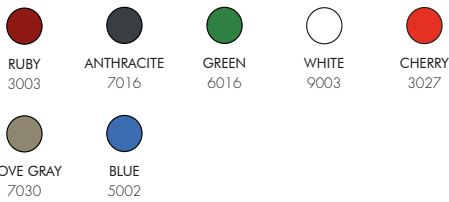

SPECIAL COLORS RESIN



*EXTRA FOR SPECIAL COLORS



FUNNY YIN T125

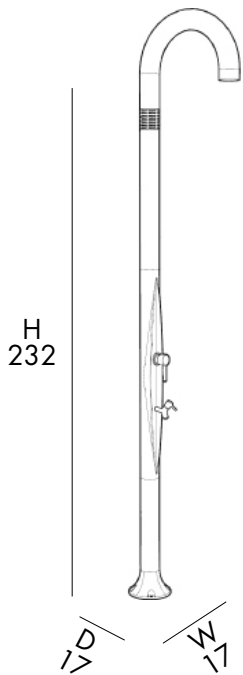

9,5 Kg



D 48 cm
H 194 cm
W 21 cm



DOCCIA TRADIZIONALE

- SOFFIONE
- MISCELATORE
- LAVAPIEDI
- REALIZZATA IN POLIETILENE COLORATO IN MASSA
- ACCESSORI IN OTTONE ABS CROMATO
- ATTACCO DOCCIA STANDARD A PAVIMENTO, SU RICHIESTA LATERALE



TRADITIONAL SHOWER

- SHOWER HEAD
- MIXER
- FOOTWASHER
- MADE OF MASS COLORED HD POLYETHYLENE
- ACCESSORIES IN CHROMED BRASS AND CHROMED ABS
- SHOWER ATTACHMENT AT THE BASE, LATERAL ON REQUEST

DOUCHE TRADITIONNELLE

- POMME DE DOUCHE
- MITIGEUR
- RINCE PIEDS
- FABRIQUÉE EN POLYÉTHYLÈNE COLORÉ DANS LA MASSE
- ACCESSOIRES EN LAITON CHROMÉ ET ABS
- RACCORDEMENT DOUCHE AU SOL, LATÉRAL SUR DEMANDE



DUCHA TRADITIONAL

- CABEZA DE DUCHA
- MEZCLADOR
- LAVAPIES
- REALIZADA EN POLIETILENO COLOREADO A GRANEL EN MASE
- ACCESORIOS DE LATÓN CROMADO Y ABS CROMO
- CONEXIÓN DE DUCHA EN EL SUELO, LATERAL BAJO PEDIDO



COLORS

STANDARD COLORS RESIN

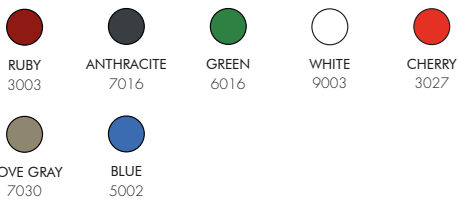

SPECIAL COLORS RESIN



*EXTRA FOR SPECIAL COLORS



FUNNY YIN T325

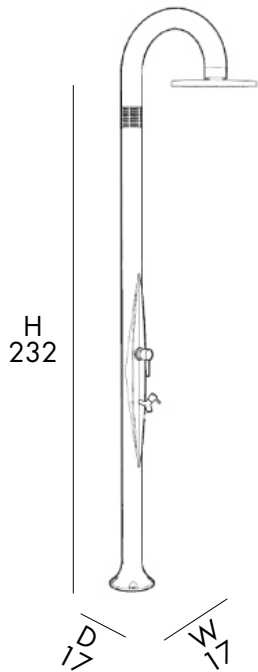

9,5 Kg



D 48 cm
H 194 cm
W 21 cm



DOCCIA TRADIZIONALE

- SOFFIONE 250mm
- MISCELATORE
- LAVAPIEDI
- REALIZZATA IN POLIETILENE COLORATO IN MASSA
- ACCESSORI IN OTTONE ABS CROMATO
- ATTACCO DOCCIA STANDARD A PAVIMENTO, SU RICHIESTA LATERALE



TRADITIONAL SHOWER

- SHOWER HEAD 250mm
- MIXER
- FOOTWASHER TAP
- MADE OF MASS COLORED HD POLYETHYLENE
- ACCESSORIES IN CHROMED BRASS AND CHROMED ABS
- SHOWER ATTACHMENT AT THE BASE, LATERAL ON REQUEST

DOUCHE TRADITIONNELLE

- POMME DE DOUCHE 250mm
- MITIGEUR
- RINCE PIEDS
- FABRIQUÉE EN POLYÉTHYLÈNE COLORÉ DANS LA MASSE
- ACCESSOIRES EN LAITON CHROMÉ ET ABS
- RACCORDEMENT DOUCHE AU SOL, LATÉRAL SUR DEMANDE



DUCHA TRADITIONAL

- CABEZA DE DUCHA 250mm
- MEZCLADOR
- LAVAPIES
- REALIZADA EN POLIETILENO COLOREADO A GRANEL EN MASE
- ACCESORIOS DE LATÓN CROMADO Y ABS CROMO
- CONEXIÓN DE DUCHA EN EL SUELO, LATERAL BAJO PEDIDO



COLORS

STANDARD COLORS RESIN

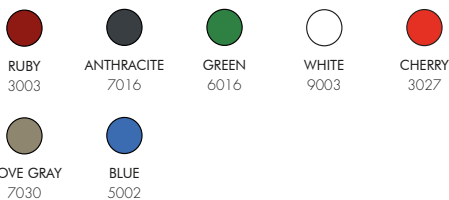

SPECIAL COLORS RESIN



*EXTRA FOR SPECIAL COLORS



FUNNY YIN T145

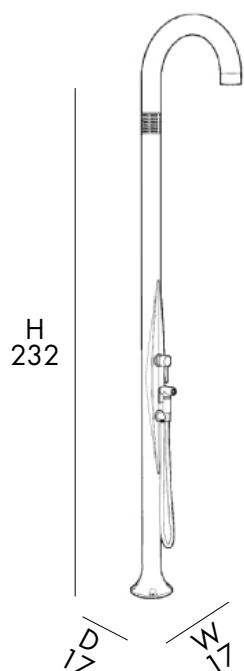

10 Kg



D 48 cm
H 194 cm
W 21 cm



DOCCIA TRADIZIONALE

- SOFFIONE
- MISCELATORE
- DOCCETTA
- REALIZZATA IN POLIETILENE COLORATO IN MASSA
- ACCESSORI IN OTTONE ABS CROMATO
- ATTACCO DOCCIA STANDARD A PAVIMENTO, SU RICHIESTA LATERALE



TRADITIONAL SHOWER

- SHOWER HEAD
- MIXER
- HAND SHOWER
- MADE OF MASS COLORED HD POLYETHYLENE
- ACCESSORIES IN CHROMED BRASS AND CHROMED ABS
- SHOWER ATTACHMENT AT THE BASE, LATERAL ON REQUEST

DOUCHE TRADITIONNELLE

- POMME DE DOUCHE
- MITIGEUR
- DOUCHETTE
- FABRIQUÉE EN POLYÉTHYLÈNE COLORÉ DANS LA MASSE
- ACCESSOIRES EN LAITON CHROMÉ ET ABS
- RACCORDEMENT DOUCHE AU SOL, LATÉRAL SUR DEMANDE



DUCHA TRADITIONAL

- CABEZA DE DUCHA
- MEZCLADOR
- DUCHA MOVIL
- REALIZADA EN POLIETILENO COLOREADO A GRANEL EN MASE
- ACCESORIOS DE LATÓN CROMADO Y ABS CROMO
- CONEXIÓN DE DUCHA EN EL SUELO, LATERAL BAJO PEDIDO



COLORS

STANDARD COLORS RESIN



RUBY
3003



ANTHRACITE
7016



GREEN
6016



WHITE
9003



CHERRY
3027



DOVE GRAY
7030



BLUE
5002

SPECIAL COLORS RESIN



VIOLET
4005



FUXIA
4003



TURQUOISE
6033



COMET
SILVER
9006



ORANGE
2009



BLUE OCEAN
5021



WINE RED
3005



LIGHT GREEN
6018

*EXTRA FOR
SPECIAL COLORS



FUNNY YIN T345

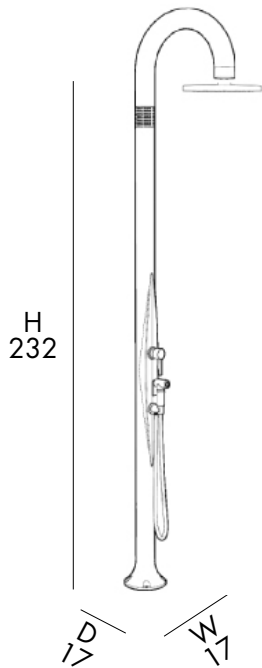

10 Kg



D 48 cm
H 194 cm
W 21 cm



DOCCIA TRADIZIONALE

- SOFFIONE 250mm
- MISCELATORE
- DOCCETTA
- REALIZZATA IN POLIETILENE COLORATO IN MASSA
- ACCESSORI IN OTTONE ABS CROMATO
- ATTACCO DOCCIA STANDARD A PAVIMENTO, SU RICHIESTA LATERALE



TRADITIONAL SHOWER

- SHOWER HEAD 250mm
- MIXER
- HAND SHOWER
- MADE OF MASS COLORED HD POLYETHYLENE
- ACCESSORIES IN CHROMED BRASS AND CHROMED ABS
- SHOWER ATTACHMENT AT THE BASE, LATERAL ON REQUEST

DOUCHE TRADITIONNELLE

- POMME DE DOUCHE 250mm
- MITIGEUR
- DOUCHETTE
- FABRIQUÉE EN POLYÉTHYLÈNE COLORÉ DANS LA MASSE
- ACCESSOIRES EN LAITON CHROMÉ ET ABS
- RACCORDEMENT DOUCHE AU SOL, LATÉRAL SUR DEMANDE



DUCHA TRADITIONAL

- CABEZA DE DUCHA 250mm
- MEZCLADOR
- DUCHA MOVIL
- REALIZADA EN POLIETILENO COLOREADO A GRANEL EN MASE
- ACCESORIOS DE LATÓN CROMADO Y ABS CROMO
- CONEXIÓN DE DUCHA EN EL SUELO, LATERAL BAJO PEDIDO



COLORS

STANDARD COLORS RESIN

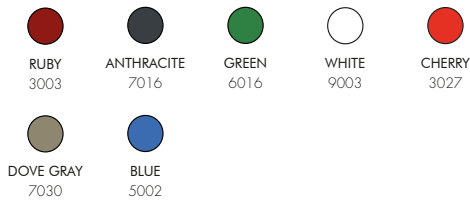

SPECIAL COLORS RESIN



*EXTRA FOR SPECIAL COLORS



FUNNY YIN T355

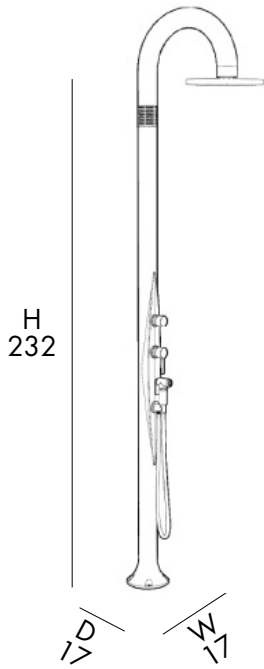

10,5 Kg



D 48 cm
H 194 cm
W 21 cm

INCLUDED



DEVIATORE
DIVERTER

DOCCIA TRADIZIONALE

- SOFFIONE 250mm
- MISCELATORE
- DOCCETTA • DEVIATORE
- REALIZZATA IN POLIETILENE COLORATO IN MASSA
- ACCESSORI IN OTTONE ABS CROMATO
- ATTACCO DOCCIA STANDARD A PAVIMENTO, SU RICHIESTA LATERALE



TRADITIONAL SHOWER

- SHOWER HEAD 250mm
- MIXER
- HAND SHOWER • DIVERTER
- MADE OF MASS COLORED HD POLYETHYLENE
- ACCESSORIES IN CHROMED BRASS AND CHROMED ABS
- SHOWER ATTACHMENT AT THE BASE, LATERAL ON REQUEST

DOUCHE TRADITIONNELLE

- POMME DE DOUCHE 250mm
- MITIGEUR
- DOUCHETTE • DÉVIEUR
- FABRIQUÉE EN POLYÉTHYLÈNE COLORÉ DANS LA MASSE
- ACCESSOIRES EN LAITON CHROMÉ ET ABS
- RACCORDEMENT DOUCHE AU SOL, LATÉRAL SUR DEMANDE



DUCHA TRADITIONAL

- CABEZA DE DUCHA 250mm
- MEZCLADOR
- DUCHA MOVIL • DEVIATOR
- REALIZADA EN POLIETILENO COLOREADO A GRANEL EN MASE
- ACCESORIOS DE LATÓN CROMADO Y ABS CROMO
- CONEXIÓN DE DUCHA EN EL SUELO, LATERAL BAJO PEDIDO



COLORS

STANDARD COLORS RESIN



RUBY
3003



ANTHRACITE
7016



GREEN
6016



WHITE
9003



CHERRY
3027



DOVE GRAY
7030



BLUE
5002

SPECIAL COLORS RESIN



VIOLET
4005



FUXIA
4003



TURQUOISE
6033



COMET
SILVER
9006



ORANGE
2009



BLUE OCEAN
5021



WINE RED
3005



LIGHT GREEN
6018

*EXTRA FOR
SPECIAL COLORS



FUNNY YIN T145-D

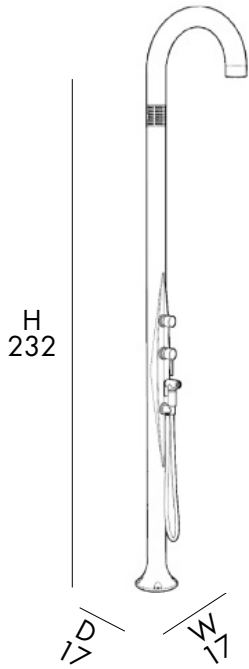

10 Kg



D 48 cm
H 194 cm
W 21 cm

INCLUDED



DEVIATORE
DIVERTER

DOCCIA TRADIZIONALE

- SOFFIONE
- MISCELATORE
- DOCCETTA • DEVIATORE
- REALIZZATA IN POLIETILENE COLORATO IN MASSA
- ACCESSORI IN OTTONE ABS CROMATO
- ATTACCO DOCCIA STANDARD A PAVIMENTO, SU RICHIESTA LATERALE



TRADITIONAL SHOWER

- SHOWER HEAD
- MIXER
- HAND SHOWER • DIVERTER
- MADE OF MASS COLORED HD POLYETHYLENE
- ACCESSORIES IN CHROMED BRASS AND CHROMED ABS
- SHOWER ATTACHMENT AT THE BASE, LATERAL ON REQUEST

DOUCHE TRADITIONNELLE

- POMME DE DOUCHE
- MITIGEUR
- DOUCHETTE • DÉVIEUR
- FABRIQUÉE EN POLYÉTHYLÈNE COLORÉ DANS LA MASSE
- ACCESSOIRES EN LAITON CHROMÉ ET ABS
- RACCORDEMENT DOUCHE AU SOL, LATÉRAL SUR DEMANDE



DUCHA TRADITIONAL

- CABEZA DE DUCHA
- MEZCLADOR
- DUCHA MOVIL • DEVIATOR
- REALIZADA EN POLIETILENO COLOREADO A GRANEL EN MASE
- ACCESORIOS DE LATÓN CROMADO Y ABS CROMO
- CONEXIÓN DE DUCHA EN EL SUELO, LATERAL BAJO PEDIDO



COLORS

STANDARD COLORS RESIN

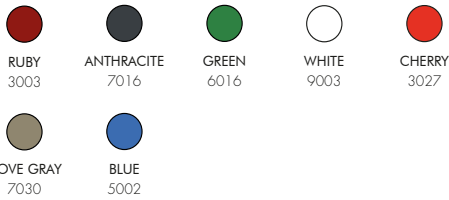

SPECIAL COLORS RESIN



*EXTRA FOR SPECIAL COLORS



FUNNY YIN T105-F

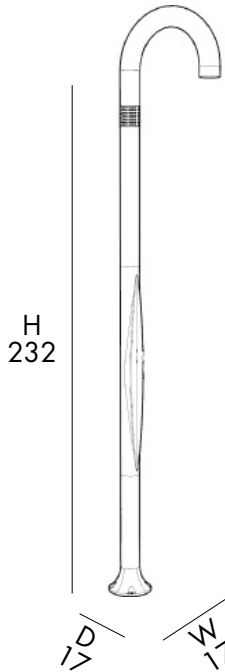

9 Kg



D 48 cm
H 194 cm
W 21 cm



DOCCIA TRADIZIONALE

- SOLO ACQUA FREDDA/COMPATIBLE CON TORRETTA A PAGAMENTO
- SOFFIONE
- REALIZZATA IN POLIETILENE COLORATO IN MASSA
- ACCESSORI IN OTTONE ABS CROMATO
- ATTACCO DOCCIA STANDARD A PAVIMENTO, SU RICHIESTA LATERALE



TRADITIONAL SHOWER

- COLD WATER ONLY/COMPATIBLE WITH TURRET FOR A FEE
- SHOWER HEAD
- MADE OF MASS COLORED HD POLYETHYLENE
- ACCESSORIES IN CHROMED BRASS AND CHROMED ABS
- SHOWER ATTACHMENT AT THE BASE, LATERAL ON REQUEST

DOUCHE TRADITIONNELLE

- EAU FROIDE UNIQUEMENT/COMPATIBLE AVEC LA TOURELLE MOYENNANT UN SUPPLÉMENT
- POMME DE DOUCHE
- FABRIQUÉE EN POLYÉTHYLÈNE COLORÉ DANS LA MASSE
- ACCESSOIRES EN LAITON CHROMÉ ET ABS
- RACCORDEMENT DOUCHE AU SOL, LATERAL SUR DEMANDE



DUCHA TRADITIONAL

- SÓLO AGUA FRÍA/COMPATIBLE CON TORRETTA POR UN SUPLEMENTO
- CABEZA DE DUCHA
- REALIZADA EN POLIETILENO COLOREADO A GRANEL EN MASE
- ACCESORIOS DE LATÓN CROMADO Y ABS CROMO
- CONEXIÓN DE DUCHA EN EL SUELO, LATERAL BAJO PEDIDO



COLORS

STANDARD COLORS RESIN



RUBY
3003



ANTHRACITE
7016



GREEN
6016



WHITE
9003



CHERRY
3027



DOVE GRAY
7030



BLUE
5002

SPECIAL COLORS RESIN



VIOLET
4005



FUXIA
4003



TURQUOISE
6033



COMET
SILVER
9006



ORANGE
2009



BLUE OCEAN
5021



WINE RED
3005



LIGHT GREEN
6018

*EXTRA FOR
SPECIAL COLORS



FUNNY YIN T305-F

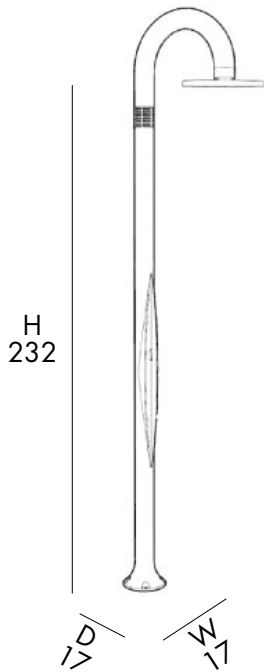

9 Kg



D 48 cm
H 194 cm
W 21 cm



DOCCIA TRADIZIONALE

- SOLO ACQUA FREDDA/COMPATIBILE CON TORRETTA A PAGAMENTO
- SOFFIONE 250mm
- REALIZZATA IN POLIETILENE COLORATO IN MASSA
- ACCESSORI IN OTTONE ABS CROMATO
- ATTACCO DOCCIA STANDARD A PAVIMENTO, SU RICHIESTA LATERALE



TRADITIONAL SHOWER

- COLD WATER ONLY/COMPATIBLE WITH TURRET FOR A FEE
- SHOWER HEAD 250mm
- MADE OF MASS COLORED HD POLYETHYLENE
- ACCESSORIES IN CHROMED BRASS AND CHROMED ABS
- SHOWER ATTACHMENT AT THE BASE, LATERAL ON REQUEST

DOUCHE TRADITIONNELLE

- EAU FROIDE UNIQUEMENT/COMPATIBLE AVEC LA TOURELLE MOYENNANT UN SUPPLÉMENT
- POMME DE DOUCHE 250mm
- FABRIQUÉE EN POLYÉTHYLÈNE COLORÉ DANS LA MASSE
- ACCESSOIRES EN LAITON CHROMÉ ET ABS
- RACCORDEMENT DOUCHE AU SOL, LATERAL SUR DEMANDE



DUCHA TRADITIONAL

- SÓLO AGUA FRÍA/COMPATIBLE CON TORRETTA POR UN SUPLEMENTO
- CABEZA DE DUCHA 250mm
- REALIZADA EN POLIETILENO COLOREADO A GRANEL EN MASE
- ACCESORIOS DE LATÓN CROMADO Y ABS CROMO
- CONEXIÓN DE DUCHA EN EL SUELO, LATERAL BAJO PEDIDO

COLORS

STANDARD COLORS RESIN

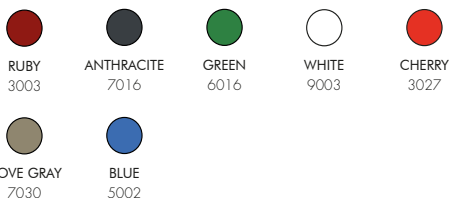

SPECIAL COLORS RESIN



*EXTRA FOR SPECIAL COLORS



FUNNY YANG T205

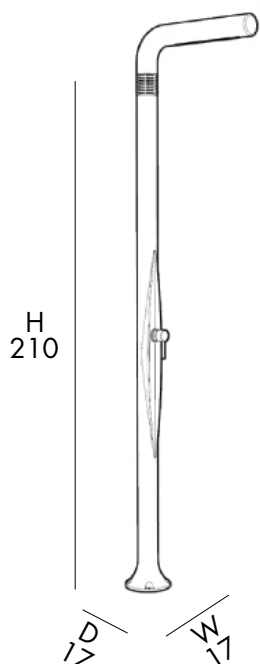

9 Kg



D 48 cm
H 194 cm
W 21 cm



DOCCIA TRADIZIONALE

- SOFFIONE
- MISCELATORE
- REALIZZATA IN POLIETILENE COLORATO IN MASSA
- ACCESSORI IN OTTONE ABS CROMATO
- ATTACCO DOCCIA STANDARD A PAVIMENTO, SU RICHIESTA LATERALE



TRADITIONAL SHOWER

- SHOWER HEAD
- MIXER
- MADE OF MASS COLORED HD POLYETHYLENE
- ACCESSORIES IN CHROMED BRASS AND CHROMED ABS
- SHOWER ATTACHMENT AT THE BASE, LATERAL ON REQUEST

DOUCHE TRADITIONNELLE

- POMME DE DOUCHE
- MITIGEUR
- FABRIQUÉE EN POLYÉTHYLÈNE COLORÉ DANS LA MASSE
- ACCESSOIRES EN LAITON CHROMÉ ET ABS
- RACCORDEMENT DOUCHE AU SOL, LATÉRAL SUR DEMANDE



DUCHA TRADITIONAL

- CABEZA DE DUCHA
- MEZCLADOR
- REALIZADA EN POLIETILENO COLOREADO A GRANEL EN MASA
- ACCESORIOS DE LATÓN CROMADO Y ABS CROMO
- CONEXIÓN DE DUCHA EN EL SUELO, LATERAL BAJO PEDIDO



COLORS

STANDARD COLORS RESIN



RUBY
3003



ANTHRACITE
7016



GREEN
6016



WHITE
9003



CHERRY
3027



DOVE GRAY
7030



BLUE
5002

SPECIAL COLORS RESIN



VIOLET
4005



FUXIA
4003



TURQUOISE
6033



COMET
SILVER
9006



ORANGE
2009



BLUE OCEAN
5021



WINE RED
3005



LIGHT GREEN
6018

*EXTRA FOR
SPECIAL COLORS



FUNNY YANG T225

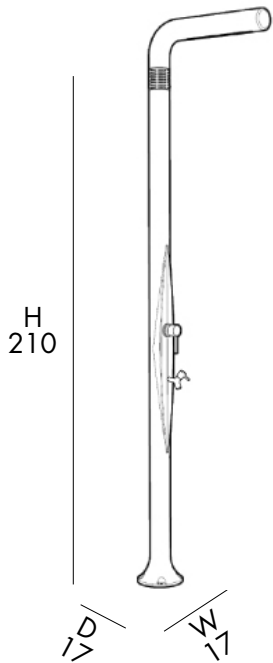

9,5 Kg



D 48 cm
H 194 cm
W 21 cm



DOCCIA TRADIZIONALE

- SOFFIONE
- MISCELATORE
- LAVAPIEDI
- REALIZZATA IN POLIETILENE COLORATO IN MASSA
- ACCESSORI IN OTTONE ABS CROMATO
- ATTACCO DOCCIA STANDARD A PAVIMENTO, SU RICHIESTA LATERALE



TRADITIONAL SHOWER

- SHOWER HEAD
- MIXER
- FOOTWASHER TAP
- MADE OF MASS COLORED HD POLYETHYLENE
- ACCESSORIES IN CHROMED BRASS AND CHROMED ABS
- SHOWER ATTACHMENT AT THE BASE, LATERAL ON REQUEST

DOUCHE TRADITIONNELLE

- POMME DE DOUCHE
- MITIGEUR
- RINCE PIEDS
- FABRIQUÉE EN POLYÉTHYLÈNE COLORÉ DANS LA MASSE
- ACCESSOIRES EN LAITON CHROMÉ ET ABS
- RACCORDEMENT DOUCHE AU SOL, LATÉRAL SUR DEMANDE



DUCHA TRADITIONAL

- CABEZA DE DUCHA
- MEZCLADOR
- LAVAPIES
- REALIZADA EN POLIETILENO COLOREADO A GRANEL EN MASE
- ACCESORIOS DE LATÓN CROMADO Y ABS CROMO
- CONEXIÓN DE DUCHA EN EL SUELO, LATERAL BAJO PEDIDO



COLORS

STANDARD COLORS RESIN

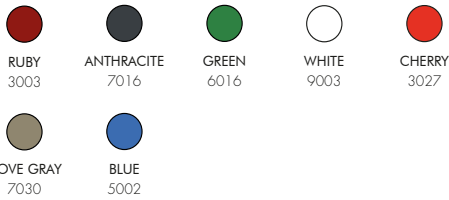

SPECIAL COLORS RESIN



*EXTRA FOR SPECIAL COLORS



FUNNY YANG T245

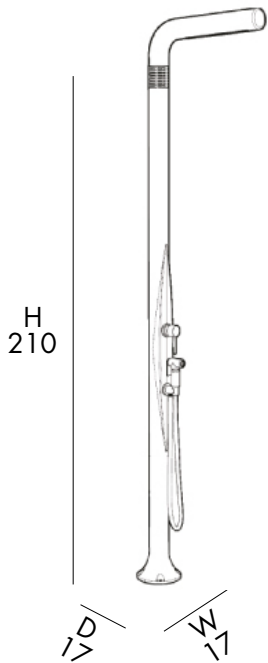

10,5 Kg



D 48 cm
H 194 cm
W 21 cm



DOCCIA TRADIZIONALE

- SOFFIONE
- MISCELATORE
- DOCCETTA
- REALIZZATA IN POLIETILENE COLORATO IN MASSA
- ACCESSORI IN OTTONE ABS CROMATO
- ATTACCO DOCCIA STANDARD A PAVIMENTO, SU RICHIESTA LATERALE



TRADITIONAL SHOWER

- SHOWER HEAD
- MIXER
- HAND SHOWER
- MADE OF MASS COLORED HD POLYETHYLENE
- ACCESSORIES IN CHROMED BRASS AND CHROMED ABS
- SHOWER ATTACHMENT AT THE BASE, LATERAL ON REQUEST

DOUCHE TRADITIONNELLE

- POMME DE DOUCHE
- MITIGEUR
- DOUCHETTE
- FABRIQUÉE EN POLYÉTHYLÈNE COLORÉ DANS LA MASSE
- ACCESSOIRES EN LAITON CHROMÉ ET ABS
- RACCORDEMENT DOUCHE AU SOL, LATÉRAL SUR DEMANDE



DUCHA TRADITIONAL

- CABEZA DE DUCHA
- MEZCLADOR
- DUCHA MOVIL
- REALIZADA EN POLIETILENO COLOREADO A GRANEL EN MASE
- ACCESORIOS DE LATÓN CROMADO Y ABS CROMO
- CONEXIÓN DE DUCHA EN EL SUELO, LATERAL BAJO PEDIDO



COLORS

STANDARD COLORS RESIN

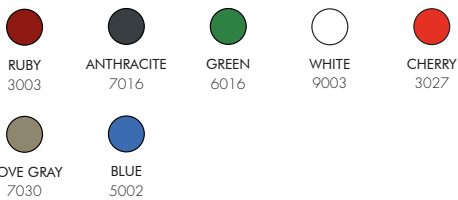

SPECIAL COLORS RESIN



*EXTRA FOR SPECIAL COLORS



FUNNY YANG T245-D

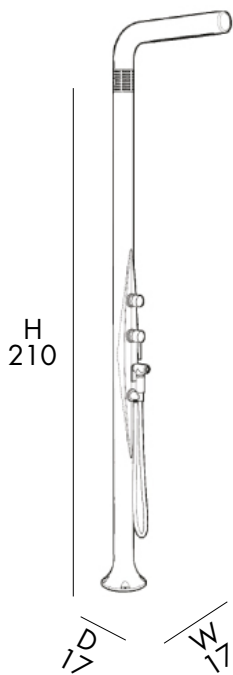

10,5 Kg



D 48 cm
H 194 cm
W 21 cm

INCLUDED



DEVIATORE
DIVERTER



DOCCIA TRADIZIONALE

- SOFFIONE
- MISCELATORE
- DOCCETTA • DEVIATORE
- REALIZZATA IN POLIETILENE COLORATO IN MASSA
- ACCESSORI IN OTTONE ABS CROMATO
- ATTACCO DOCCIA STANDARD A PAVIMENTO, SU RICHIESTA LATERALE



TRADITIONAL SHOWER

- SHOWER HEAD
- MIXER
- HAND SHOWER • DIVERTER
- MADE OF MASS COLORED HD POLYETHYLENE
- ACCESSORIES IN CHROMED BRASS AND CHROMED ABS
- SHOWER ATTACHMENT AT THE BASE, LATERAL ON REQUEST

DOUCHE TRADITIONNELLE

- POMME DE DOUCHE
- MITIGEUR
- DOUCHETTE • DÉVIEUR
- FABRIQUÉE EN POLYÉTHYLÈNE COLORÉ DANS LA MASSE
- ACCESSOIRES EN LAITON CHROMÉ ET ABS
- RACCORDEMENT DOUCHE AU SOL, LATÉRAL SUR DEMANDE



DUCHA TRADITIONAL

- CABEZA DE DUCHA
- MEZCLADOR
- DUCHA MOVIL • DEVIATOR
- REALIZADA EN POLIETILENO COLOREADO A GRANEL EN MASE
- ACCESORIOS DE LATÓN CROMADO Y ABS CROMO
- CONEXIÓN DE DUCHA EN EL SUELO, LATERAL BAJO PEDIDO

COLORS

STANDARD COLORS RESIN

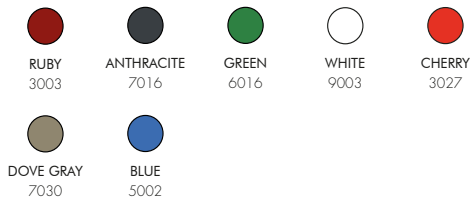

SPECIAL COLORS RESIN



*EXTRA FOR
SPECIAL COLORS



FUNNY YANG T205-F

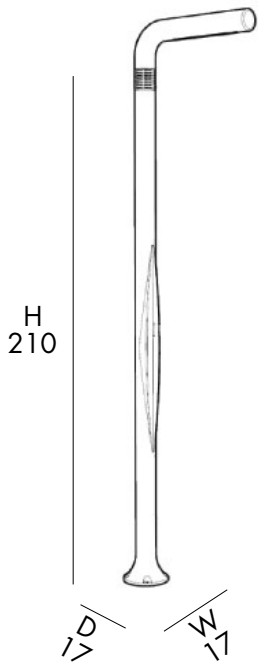

9 Kg



D 48 cm
H 194 cm
W 21 cm

DOCCIA TRADIZIONALE

- SOLO ACQUA FREDDA/COMPATIBLE CON TORRETTA A PAGAMENTO
- SOFFIONE
- REALIZZATA IN POLIETILENE COLORATO IN MASSA
- ACCESSORI IN OTTONE ABS CROMATO
- ATTACCO DOCCIA STANDARD A PAVIMENTO, SU RICHIESTA LATERALE



TRADITIONAL SHOWER

- COLD WATER ONLY/COMPATIBLE WITH TURRET FOR A FEE
- SHOWER HEAD
- MADE OF MASS COLORED HD POLYETHYLENE
- ACCESSORIES IN CHROMED BRASS AND CHROMED ABS
- SHOWER ATTACHMENT AT THE BASE, LATERAL ON REQUEST

DOUCHE TRADITIONNELLE

- EAU FROIDE UNIQUEMENT/COMPATIBLE AVEC LA TOURELLE MOYENNANT UN SUPPLÉMENT
- POMME DE DOUCHE
- FABRIQUÉE EN POLYÉTHYLÈNE COLORÉ DANS LA MASSE
- ACCESSOIRES EN LAITON CHROMÉ ET ABS
- RACCORDEMENT DOUCHE AU SOL, LATÉRAL SUR DEMANDE



DUCHA TRADITIONAL

- SÓLO AGUA FRÍA/COMPATIBLE CON TORRETTA POR UN SUPLEMENTO
- CABEZA DE DUCHA
- REALIZADA EN POLIETILENO COLOREADO A GRANEL EN MASE
- ACCESORIOS DE LATÓN CROMADO Y ABS CROMO
- CONEXIÓN DE DUCHA EN EL SUELO, LATERAL BAJO PEDIDO



COLORS

STANDARD COLORS RESIN



RUBY
3003



ANTHRACITE
7016



GREEN
6016



WHITE
9003



CHERRY
3027



DOVE GRAY
7030



BLUE
5002

SPECIAL COLORS RESIN



VIOLET
4005



FUXIA
4003



TURQUOISE
6033



COMET
SILVER
9006



ORANGE
2009



BLUE OCEAN
5021



WINE RED
3005



LIGHT GREEN
6018

*EXTRA FOR
SPECIAL COLORS



SPRING PLUS B125-I

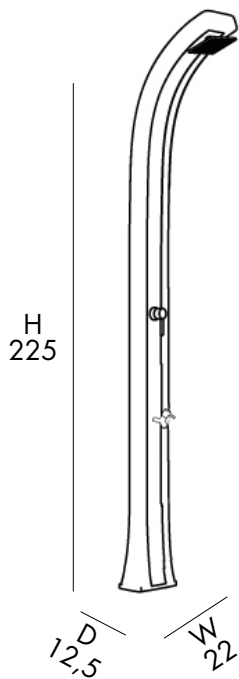

9 Kg



D 45 cm
H 232 cm
W 27 cm



DOCCIA TRADIZIONALE

- SOFFIONE
- MISCELATORE
- LAVAPIEDI • BANDA INOX
- REALIZZATA IN POLIETILENE COLORATO IN MASSA
- ACCESSORI IN OTTONE ABS CROMATO
- ATTACCO DOCCIA POSTERIORE

TRADITIONAL SHOWER

- SHOWER HEAD
- MIXER
- FOOTWASHER TAP • INOX BAND
- MADE OF MASS COLORED HD POLYETHYLENE
- ACCESSORIES IN CHROMED BRASS AND CHROMED ABS
- REAR SHOWER ATTACHMENT

DOUCHE TRADITIONNELLE

- POMME DE DOUCHE
- MITIGEUR
- RINCE PIEDS • BANDE INOX
- FABRIQUÉE EN POLYÉTHYLÈNE COLORÉ DANS LA MASSE
- ACCESSOIRES EN LAITON CHROMÉ ET ABS
- ACCESSOIRE DE DOUCHE ARRIÈRE

DUCHA TRADITIONAL

- CABEZA DE DUCHA
- MEZCLADOR
- LAVAPIES • BANDA INOX
- REALIZADA EN POLIETILENO COLOREADO A GRANULOS EN MASA
- ACCESORIOS DE LATÓN CROMADO Y ABS CROMO
- ACCESORIO DE DUCHA TRASERA



COLORS

STANDARD COLORS RESIN

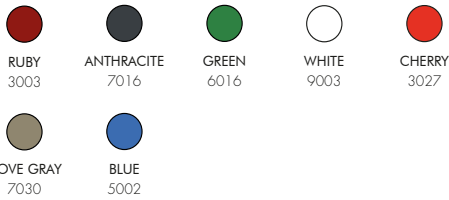

SPECIAL COLORS RESIN



*EXTRA FOR SPECIAL COLORS



SPRING PLUS B145-I

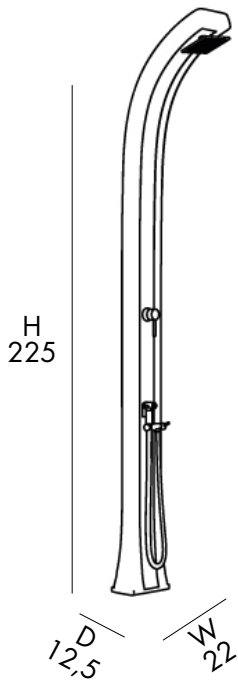

10 Kg



D 45 cm
H 232 cm
W 27 cm

DOCCIA TRADIZIONALE

- SOFFIONE
- MISCELATORE
- DOCCETTA • BANDA INOX
- REALIZZATA IN POLIETILENE COLORATO IN MASSA
- ACCESSORI IN OTTONE ABS CROMATO
- ATTACCO DOCCIA POSTERIORE



TRADITIONAL SHOWER

- SHOWER HEAD
- MIXER
- HAND SHOWER • INOX BAND
- MADE OF MASS COLORED HD POLYETHYLENE
- ACCESSORIES IN CHROMED BRASS AND CHROMED ABS
- REAR SHOWER ATTACHMENT

DOUCHE TRADITIONNELLE

- POMME DE DOUCHE
- MITIGEUR
- DOUCHETTE • BANDE INOX
- FABRIQUÉE EN POLYÉTHYLÈNE COLORÉ DANS LA MASSE
- ACCESSOIRES EN LAITON CHROMÉ ET ABS
- ACCESSOIRE DE DOUCHE ARRIÈRE



DUCHA TRADITIONAL

- CABEZA DE DUCHA
- MEZCLADOR
- DUCHA MOVIL • BANDA INOX
- REALIZADA EN POLIETILENO COLOREADO A GRANULOS EN MASA
- ACCESORIOS DE LATÓN CROMADO Y ABS CROMO
- ACCESORIO DE DUCHA TRASERA



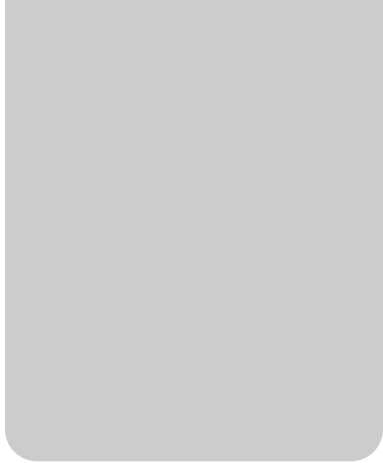

Una storia di successi dal 1988
A story of successes since 1988

ARKEMA®
DESIGN

MADE IN ITALY

Sostenibili per natura
Sustainable by nature



ARKEMA
EBLON
MADE IN ITALY

ET488
C.E.
06/2025

**TRADITIONAL
SHOWERS
ALLUMINIUM**



COLORS

STANDARD COLORS ALUMINIUM

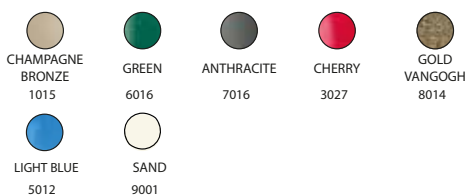

SPECIAL COLORS ALUMINIUM



*EXTRA FOR
SPECIAL COLORS

€

JOLLY A505

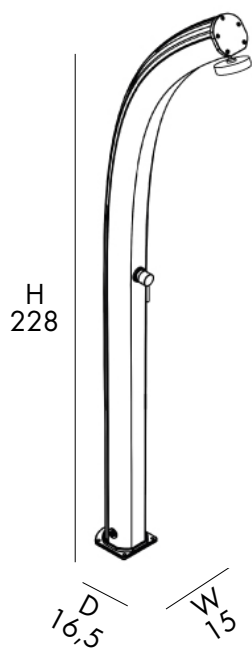

 14,5 Kg

 D 48 cm
H 232 cm
W 16 cm

DOCCIA TRADIZIONALE

- SOFFIONE
- MISCELATORE
- REALIZZATA IN ALLUMINIO VERNICIATO A POLVERE
- ACCESSORI IN OTTONE ABS CROMATO
- ATTACCO DOCCIA LATERALE DESTRO

TRADITIONAL SHOWER

- SHOWER HEAD
- MIXER
- MADE OF POWDER COATED ALUMINIUM
- ACCESSORIES IN CHROMED BRASS AND CHROMED ABS
- RIGHT SIDE SHOWER ATTACHMENT

DOUCHE TRADITIONNELLE

- POMME DE DOUCHE
- MITIGEUR
- FABRIQUÉE EN ALUMINIUM PEINT EN POUVRE
- ACCESSOIRES EN LAITON CHROMÉ ET ABS
- RACCORDEMENT DE DOUCHE COTÉ DROIT

DUCHA TRADITIONAL

- CABEZA DE DUCHA
- MEZCLADOR
- REALIZADA EN ALUMINIO PINTADO EN POLVO
- ACCESORIOS DE LATÓN CROMADO Y ABS CROMO
- ACCESORIO DE DUCHA DEL LADO DERECHO



COLORS

STANDARD COLORS ALUMINIUM

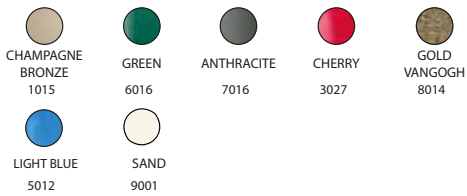

SPECIAL COLORS ALUMINIUM



*EXTRA FOR
SPECIAL COLORS

€

JOLLY A525

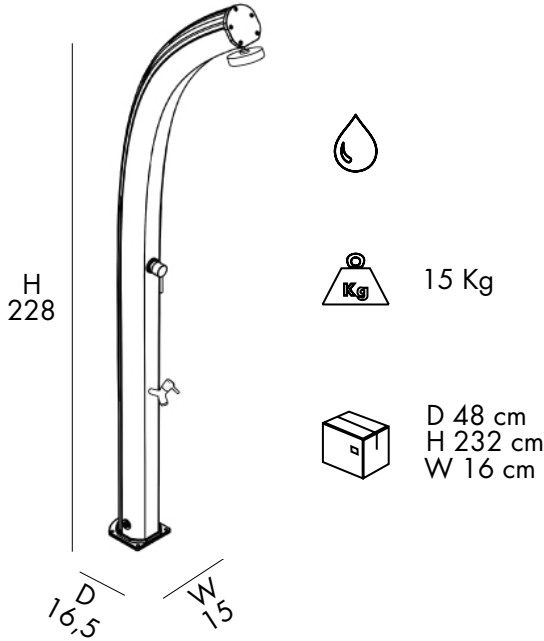

DOCCIA TRADIZIONALE

- SOFFIONE
- MISCELATORE
- LAVAPIEDI
- REALIZZATA IN ALLUMINIO VERNICIATO A POLVERE
- ACCESSORI IN OTTONE ABS CROMATO
- ATTACCO DOCCIA LATERALE DESTRO

TRADITIONAL SHOWER

- SHOWER HEAD
- MIXER
- FOOTWASHER TAP
- MADE OF POWDER COATED ALUMINIUM
- ACCESSORIES IN CHROMED BRASS AND CHROMED ABS
- RIGHT SIDE SHOWER ATTACHMENT

DOUCHE TRADITIONNELLE

- POMME DE DOUCHE
- MITIGEUR
- RINCE PIEDS
- FABRIQUÉE EN ALUMINIUM PEINT EN POUDRE
- ACCESSOIRES EN LAITON CHROMÉ ET ABS
- RACCORDEMENT DE DOUCHE COTÉ DROIT

DUCHA TRADITIONAL

- CABEZA DE DUCHA
- MEZCLADOR
- LAVAPIES
- REALIZADA EN ALUMINIO PINTADO EN POLVO
- ACCESORIOS DE LATÓN CROMADO Y ABS CROMO
- ACCESORIO DE DUCHA DEL LADO DERECHO



COLORS

STANDARD COLORS ALUMINIUM

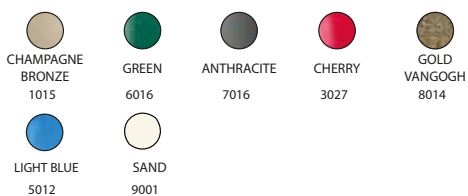

SPECIAL COLORS ALUMINIUM



*EXTRA FOR
SPECIAL COLORS



JOLLY A535

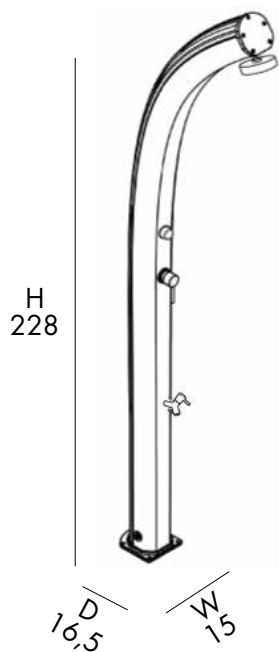

 16 Kg

 D 48 cm
H 232 cm
W 16 cm

DOCCIA TRADIZIONALE

- SOFFIONE
- MISCELATORE
- LAVAPIEDI • TEMPORIZZATORE
- REALIZZATA IN ALLUMINIO VERNICIATO A POLVERE
- ACCESSORI IN OTTONE ABS CROMATO
- ATTACCO DOCCIA LATERALE

TRADITIONAL SHOWER

- SHOWER HEAD
- MIXER
- FOOTWASHER TAP • TEMPORIZED BUTTON
- MADE OF POWDER COATED ALUMINIUM
- ACCESSORIES IN CHROMED BRASS AND CHROMED ABS
- RIGHT SIDE SHOWER ATTACHMENT

DOUCHE TRADITIONNELLE

- POMME DE DOUCHE
- MITIGEUR
- RINCE PIEDS • BOUTON TEMPORISÉ
- FABRIQUÉE EN ALUMINIUM PEINT EN POUVRE
- ACCESSOIRES EN LAITON CHROMÉ ET ABS
- RACCORD DE DOUCHE COTÉ DROIT

DUCHA TRADITIONAL

- CABEZA DE DUCHA
- MEZCLADOR
- LAVAPIES • BOTON TEMPORIZADO
- REALIZADA EN ALUMINIO PINTADO EN POLVO
- ACCESORIOS DE LATÓN CROMADO Y ABS CROMO
- ACCESORIO DE DUCHA DE LADO DERECHO



COLORS

STANDARD COLORS ALUMINIUM

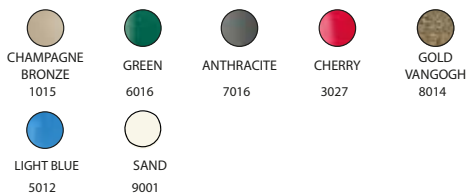

SPECIAL COLORS ALUMINIUM



*EXTRA FOR
SPECIAL COLORS



JOLLY S A625

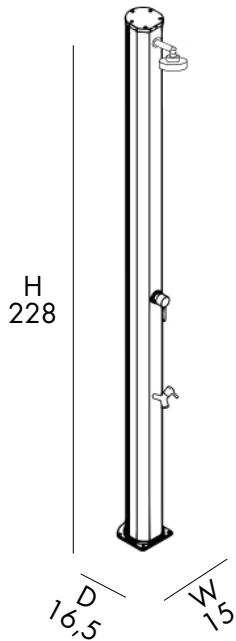

14,5 Kg



D 33 cm
H 234 cm
W 15 cm

DOCCIA TRADIZIONALE

- SOFFIONE
- MISCELATORE
- LAVAPIEDI
- REALIZZATA IN ALLUMINIO VERNICIATO A POLVERE
- ACCESSORI IN OTTONE ABS CROMATO
- ATTACCO DOCCIA LATERALE



TRADITIONAL SHOWER

- SHOWER HEAD
- MIXER
- FOOTWASHER TAP
- MADE OF POWDER COATED ALUMINIUM
- ACCESSORIES IN CHROMED BRASS AND CHROMED ABS
- RIGHT SIDE SHOWER ATTACHMENT

DOUCHE TRADITIONNELLE

- POMME DE DOUCHE
- MITIGEUR
- RINCE PIEDS
- FABRIQUÉE EN ALUMINIUM PEINT EN POUVRE
- ACCESSOIRES EN LAITON CHROMÉ ET ABS
- RACCORD DE DOUCHE COTÉ DROIT



DUCHA TRADITIONAL

- CABEZA DE DUCHA
- MEZCLADOR
- LAVAPIES
- REALIZADA EN ALUMINIO PINTADO EN POLVO
- ACCESORIOS DE LATÓN CROMADO Y ABS CROMO
- ACCESORIO DE DUCHA DE LADO DERECHO



COLORS

STANDARD COLORS ALUMINIUM

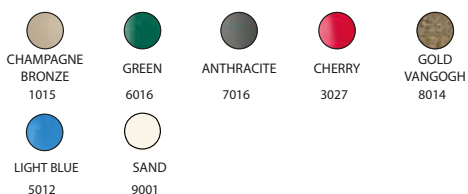

SPECIAL COLORS ALUMINIUM



*EXTRA FOR
SPECIAL COLORS

€

BIG JOLLY A365/2

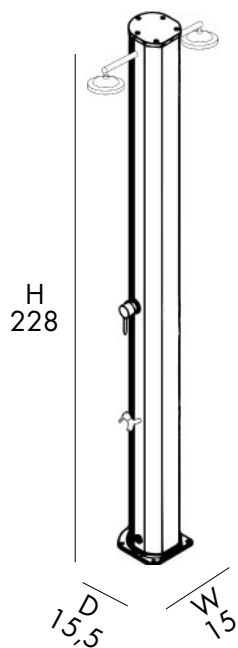

20 Kg



D 35 cm
H 234 cm
W 23 cm



DOCCIA TRADIZIONALE

- 2 SOFFIONI
- MISCELATORE
- 2 LAVAPIEDI
- REALIZZATA IN ALLUMINIO VERNICIATO A POLVERE
- ACCESSORI IN OTTONE ABS CROMATO
- ATTACCO DOCCIA STANDARD A PAVIMENTO, SU RICHIESTA LATERALE

TRADITIONAL SHOWER

- 2 SHOWER HEADS
- MIXER
- 2 FOOTWASHER TAP
- MADE OF POWDER COATED ALUMINIUM
- ACCESSORIES IN CHROMED BRASS AND CHROMED ABS
- SHOWER ATTACHMENT AT THE FLOOR, LATERAL ON REQUEST

DOUCHE TRADITIONNELLE

- 2 POMMES DE DOUCHE
- MITIGEUR
- 2 RINCE PIEDS
- FABRIQUÉE EN ALUMINIUM PEINT EN POUDRE
- ACCESSOIRES EN LAITON CHROMÉ ET ABS
- RACCORDEMENT DOUCHE AU SOL, LATERAL SUR DEMANDE

DUCHA TRADITIONAL

- 2 CABEZAS DE DUCHA
- MEZCLADOR
- 2 LAVAPIES
- REALIZADA EN ALUMINIO PINTADO EN POLVO
- ACCESORIOS DE LATÓN CROMADO Y ABS CROMO
- CONEXIÓN DE DUCHA EN EL SUELO, LATERAL BAJO PEDIDO

COLORS

STANDARD COLORS ALUMINIUM

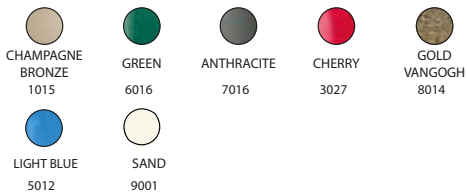

SPECIAL COLORS ALUMINIUM



*EXTRA FOR
SPECIAL COLORS



BIG JOLLY A365

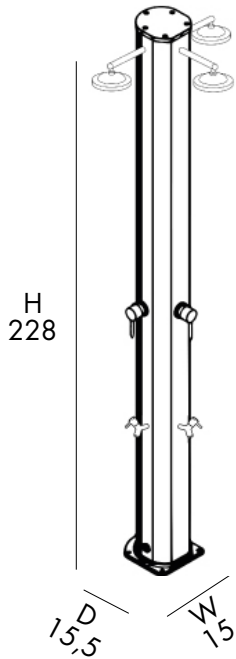

20 Kg



D 35 cm
H 234 cm
W 23 cm

DOCCIA TRADIZIONALE

- 3 SOFFIONI
- MISCELATORI
- 3 LAVAPIEDI
- REALIZZATA IN ALLUMINIO VERNICIATO A POLVERE
- ACCESSORI IN OTTONE ABS CROMATO
- ATTACCO DOCCIA STANDARD A PAVIMENTO, SU RICHIESTA LATERALE



TRADITIONAL SHOWER

- 3 SHOWER HEADS
- MIXERS
- 3 FOOTWASHER TAP
- MADE OF POWDER COATED ALUMINIUM
- ACCESSORIES IN CHROMED BRASS AND CHROMED ABS
- SHOWER ATTACHMENT AT THE FLOOR, LATERAL ON REQUEST

DOUCHE TRADITIONNELLE

- 3 POMMES DE DOUCHE
- MITIGEURS
- 3 RINCE PIEDS
- FABRIQUÉE EN ALUMINIUM PEINT EN POUDRE
- ACCESSOIRES EN LAITON CHROMÉ ET ABS
- RACCORDEMENT DOUCHE AU SOL, LATERAL SUR DEMANDE



DUCHA TRADITIONAL

- 3 CABEZAS DE DUCHA
- MEZCLADOR
- 3 LAVAPIES
- REALIZADA EN ALUMINIO PINTADO EN POLVO
- ACCESORIOS DE LATÓN CROMADO Y ABS CROMO
- CONEXIÓN DE DUCHA EN EL SUELO, LATERAL BAJO PEDIDO



COLORS

STANDARD COLORS ALUMINIUM

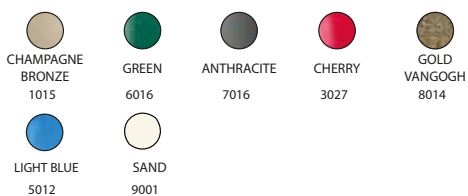

SPECIAL COLORS ALUMINIUM



*EXTRA FOR INOX BAND	€
*EXTRA FOR SPECIAL COLORS	€

SPRING A105

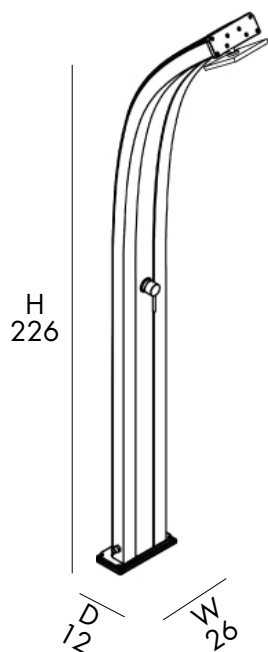

18 Kg



D 43 cm
H 231 cm
W 29 cm

DOCCIA TRADIZIONALE

- SOFFIONE
- MISCELATORE
- REALIZZATA IN ALLUMINIO VERNICIATO A POLVERE
- ACCESSORI IN OTTONE ABS CROMATO
- ATTACCO DOCCIA POSTERIORE



TRADITIONAL SHOWER

- SHOWER HEAD
- MIXER
- MADE OF POWDER COATED ALUMINIUM
- ACCESSORIES IN CHROMED BRASS AND CHROMED ABS
- REAR SHOWER ATTACHMENT

DOUCHE TRADITIONNELLE

- POMME DE DOUCHE
- MITIGEUR
- FABRIQUÉE EN ALUMINIUM PEINT EN POUDRE
- ACCESSOIRES EN LAITON CHROMÉ ET ABS
- RACCORDEMENT DE DOUCHE ARRIÈRE



DUCHA TRADITIONAL

- CABEZA DE DUCHA
- MEZCLADOR
- REALIZADA EN ALUMINIO PINTADO EN POLVO
- ACCESORIOS DE LATÓN CROMADO Y ABS CROMO
- ACCESORIO DE DUCHA TRASERA



COLORS

STANDARD COLORS ALUMINIUM

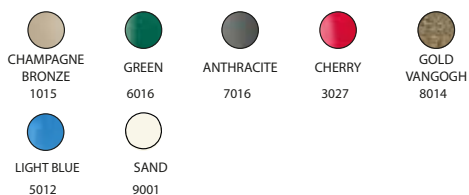

SPECIAL COLORS ALUMINIUM



*EXTRA FOR INOX BAND	€
*EXTRA FOR SPECIAL COLORS	€

SPRING A125

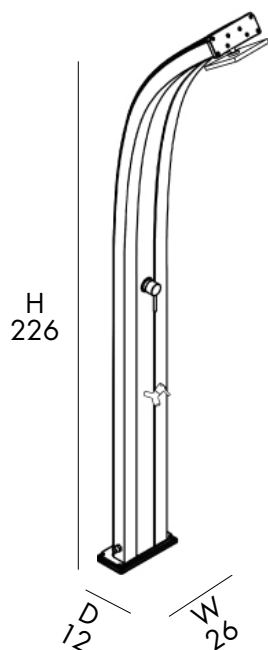

18,5 Kg



D 43 cm
H 231 cm
W 29 cm



DOCCIA TRADIZIONALE

- SOFFIONE
- MISCELATORE
- LAVAPIEDI
- REALIZZATA IN ALLUMINIO VERNICIATO A POLVERE
- ACCESSORI IN OTTONE ABS CROMATO
- ATTACCO DOCCIA POSTERIORE



TRADITIONAL SHOWER

- SHOWER HEAD
- MIXER
- FOOTWASHER TAP
- MADE OF POWDER COATED ALUMINIUM
- ACCESSORIES IN CHROMED BRASS AND CHROMED ABS
- REAR SHOWER ATTACHMENT

DOUCHE TRADITIONNELLE

- POMME DE DOUCHE
- MITIGEUR
- RINCE PIEDS
- FABRIQUÉE EN ALUMINIUM PEINT EN POUVRE
- ACCESSOIRES EN LAITON CHROMÉ ET ABS
- RACCORDEMENT DE DOUCHE ARRIÈRE



DUCHA TRADITIONAL

- CABEZA DE DUCHA
- MEZCLADOR
- LAVAPIES
- REALIZADA EN ALUMINIO PINTADO EN POLVO
- ACCESORIOS DE LATÓN CROMADO Y ABS CROMO
- ACCESORIO DE DUCHA TRASERA

COLORS

STANDARD COLORS ALUMINIUM

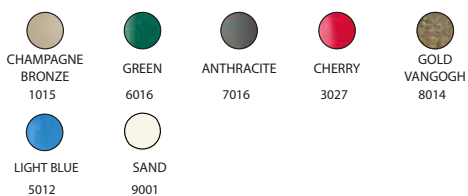

SPECIAL COLORS ALUMINIUM



*EXTRA FOR INOX BAND	€
*EXTRA FOR SPECIAL COLORS	€

SPRING S A205

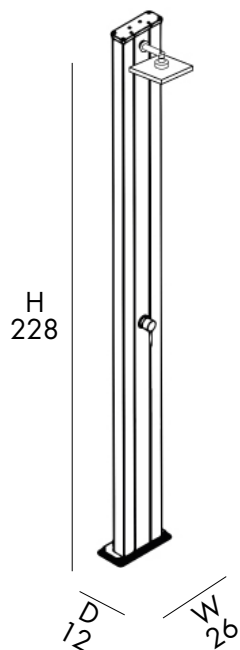

17,5 Kg



D 28 cm
H 232 cm
W 24 cm

DOCCIA TRADIZIONALE

- SOFFIONE
- MISCELATORE
- REALIZZATA IN ALLUMINIO VERNICIATO A POLVERE
- ACCESSORI IN OTTONE ABS CROMATO
- ATTACCO DOCCIA POSTERIORE

TRADITIONAL SHOWER

- SHOWER HEAD
- MIXER
- MADE OF POWDER COATED ALUMINIUM
- ACCESSORIES IN CHROMED BRASS AND CHROMED ABS
- REAR SHOWER ATTACHMENT

DOUCHE TRADITIONNELLE

- POMME DE DOUCHE
- MITIGEUR
- FABRIQUÉE EN ALUMINIUM PEINT EN POUVRE
- ACCESSOIRES EN LAITON CHROMÉ ET ABS
- RACCORDEMENT DE DOUCHE ARRIÈRE

DUCHA TRADITIONAL

- CABEZA DE DUCHA
- MEZCLADOR
- REALIZADA EN ALUMINIO PINTADO EN POLVO
- ACCESORIOS DE LATÓN CROMADO Y ABS CROMO
- ACCESORIO DE DUCHA TRASERA



COLORS

STANDARD COLORS ALUMINIUM

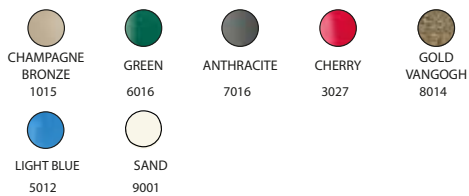

SPECIAL COLORS ALUMINIUM



*EXTRA FOR INOX BAND	€
*EXTRA FOR SPECIAL COLORS	€

SPRING S A225

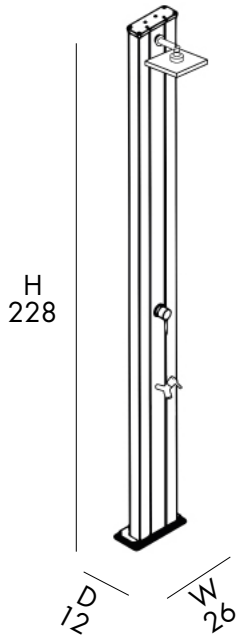

18 Kg



D 28 cm
H 232 cm
W 24 cm

DOCCIA TRADIZIONALE

- SOFFIONE
- MISCELATORE
- LAVAPIEDI
- REALIZZATA IN ALLUMINIO VERNICIATO A POLVERE
- ACCESSORI IN OTTONE ABS CROMATO
- ATTACCO DOCCIA POSTERIORE



TRADITIONAL SHOWER

- SHOWER HEAD
- MIXER
- FOOTWASHER TAP
- MADE OF POWDER COATED ALUMINIUM
- ACCESSORIES IN CHROMED BRASS AND CHROMED ABS
- REAR SHOWER ATTACHMENT

DOUCHE TRADITIONNELLE

- POMME DE DOUCHE
- MITIGEUR
- RINCE PIEDS
- FABRIQUÉE EN ALUMINIUM PEINT EN POUVRE
- ACCESSOIRES EN LAITON CHROMÉ ET ABS
- RACCORDEMENT DE DOUCHE ARRIÈRE



DUCHA TRADITIONAL

- CABEZA DE DUCHA
- MEZCLADOR
- LAVAPIES
- REALIZADA EN ALUMINIO PINTADO EN POLVO
- ACCESORIOS DE LATÓN CROMADO Y ABS CROMO
- ACCESORIO DE DUCHA TRASERA



COLORS

STANDARD COLORS ALUMINIUM

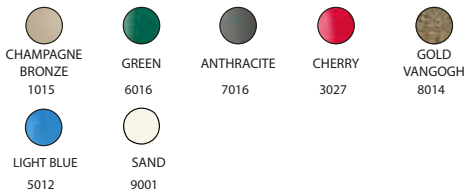

SPECIAL COLORS ALUMINIUM



*EXTRA FOR INOX BAND	€
*EXTRA FOR SPECIAL COLORS	€

DADA D325

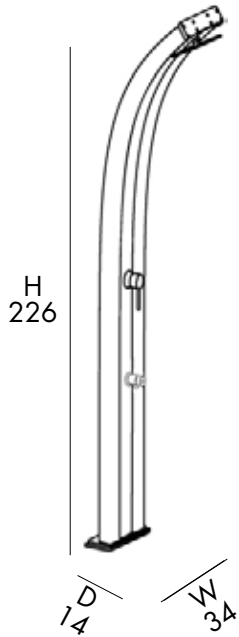

28 Kg



D 45 cm
H 231 cm
W 36 cm



DOCCIA TRADIZIONALE

- SOFFIONE
- MISCELATORE
- LAVAPIEDI TEMPORIZZATO
- REALIZZATA IN ALLUMINIO VERNICIATO A POLVERE
- ACCESSORI IN OTTONE ABS CROMATO
- ATTACCO DOCCIA POSTERIORE

TRADITIONAL SHOWER

- SHOWER HEAD
- MIXER
- TEMPORIZED FOOTWASHER TAP
- MADE OF POWDER COATED ALUMINIUM
- ACCESSORIES IN CHROMED BRASS AND CHROMED ABS
- REAR SHOWER ATTACHMENT

DOUCHE TRADITIONNELLE

- POMME DE DOUCHE
- MITIGEUR
- RINCE PIEDS TEMPORISÉ
- FABRIQUÉE EN ALUMINIUM PEINT EN POUVRE
- ACCESSOIRES EN LAITON CHROMÉ ET ABS
- RACCORDEMENT DE DOUCHE ARRIÈRE

DUCHA TRADITIONAL

- CABEZA DE DUCHA
- MEZCLADOR
- LAVAPIES TEMPORIZADO
- REALIZADA EN ALUMINIO PINTADO EN POLVO
- ACCESORIOS DE LATÓN CROMADO Y ABS CROMO
- ACCESORIO DE DUCHA TRASERA

COLORS

STANDARD COLORS ALUMINIUM

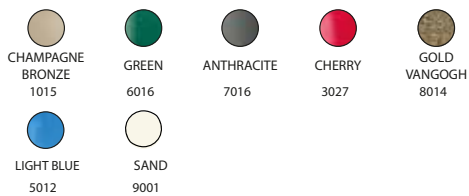

SPECIAL COLORS ALUMINIUM



*EXTRA FOR INOX BAND	€
*EXTRA FOR SPECIAL COLORS	€

DADA D345

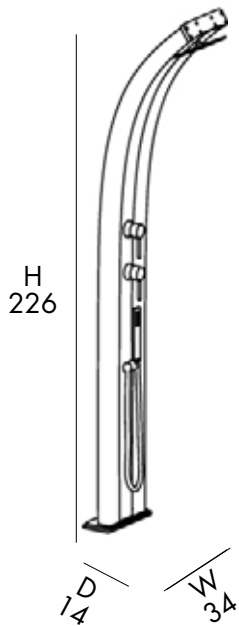

29 Kg



D 45 cm
H 231 cm
W 36 cm

INCLUDED



DOCCIA TRADIZIONALE

- SOFFIONE
- MISCELATORE
- DOCCETTA • DEVIATORE
- REALIZZATA IN ALLUMINIO VERNICIATO A POLVERE
- ACCESSORI IN OTTONE ABS CROMATO
- ATTACCO DOCCIA POSTERIORE



TRADITIONAL SHOWER

- SHOWER HEAD
- MIXER
- HAND SHOWER • DEVERTER
- MADE OF POWDER COATED ALUMINIUM
- ACCESSORIES IN CHROMED BRASS AND CHROMED ABS
- REAR SHOWER ATTACHMENT

DOUCHE TRADITIONNELLE

- POMME DE DOUCHE
- MITIGEUR
- DOUCHETTE • DÉVIEUR
- FABRIQUÉE EN ALUMINIUM PEINT EN POUVRE
- ACCESSOIRES EN LAITON CHROMÉ ET ABS
- RACCORDEMENT DE DOUCHE ARRIÈRE



DUCHA TRADITIONAL

- CABEZA DE DUCHA
- MEZCLADOR
- DUCHA MOVIL • DEVIATORE
- REALIZADA EN ALUMINIO PINTADO EN POLVO
- ACCESORIOS DE LATÓN CROMADO Y ABS CROMO
- ACCESORIO DE DUCHA TRASERA



COLORS

STANDARD COLORS ALUMINIUM

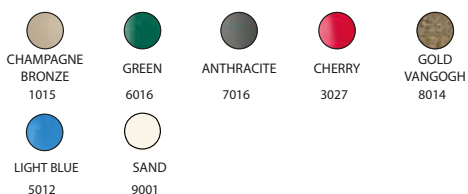

SPECIAL COLORS ALUMINIUM



*EXTRA FOR INOX BAND	€
*EXTRA FOR SPECIAL COLORS	€

DADA D355

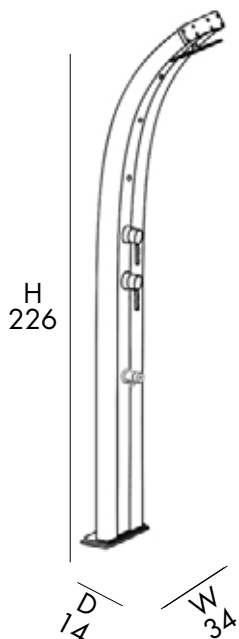

29 Kg



D 45 cm
H 231 cm
W 36 cm

INCLUDED



DEVIATORE
DIVERTER



DOCCIA TRADIZIONALE

- SOFFIONE
- MISCELATORE
- LAVAPIEDI TEMPORIZZATO • 3 NEBULIZZATORI
- REALIZZATA IN ALLUMINIO VERNICIATO A POLVERE
- ACCESSORI IN OTTONE ABS CROMATO
- ATTACCO DOCCIA POSTERIORE

TRADITIONAL SHOWER

- SHOWER HEAD
- MIXER
- TEMPORIZED FOOTWASHER TAP • 3 NEBULIZERS
- MADE OF POWDER COATED ALUMINIUM
- ACCESSORIES IN CHROMED BRASS AND CHROMED ABS
- REAR SHOWER ATTACHMENT

DOUCHE TRADITIONNELLE

- POMME DE DOUCHE
- MITIGEUR
- RINCE PIEDS TEMPORISÉ • 3 NEBULISEURS
- FABRIQUÉE EN ALUMINIUM PEINT EN POUDRE
- ACCESSOIRES EN LAITON CHROMÉ ET ABS
- RACCORDEMENT DE DOUCHE ARRIÈRE

DUCHA TRADITIONAL

- CABEZA DE DUCHA
- MEZCLADOR
- LAVAPIES TEMPORIZADO • 3 NEBULIZADORES
- REALIZADA EN ALUMINIO PINTADO EN POLVO
- ACCESORIOS DE LATÓN CROMADO Y ABS CROMO
- ACCESORIO DE DUCHA TRASERA

COLORS

STANDARD COLORS ALUMINIUM

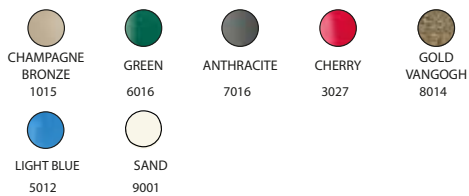

SPECIAL COLORS ALUMINIUM



*EXTRA FOR INOX BAND	€
*EXTRA FOR SPECIAL COLORS	€

DADA S D455

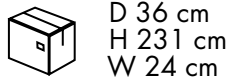
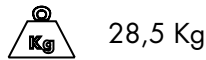
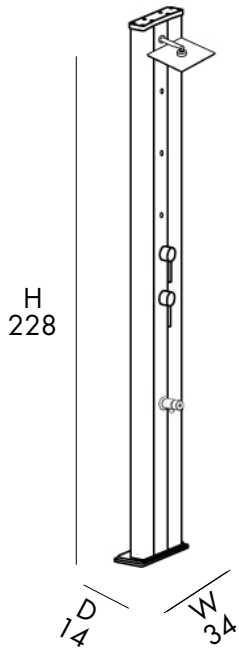

INCLUDED



DOCCIA TRADIZIONALE

- SOFFIONE
- MISCELATORE
- LAVAPIEDI TEMPORIZZATO • DEVIATORE • 3 NEBULIZZATORI
- REALIZZATA IN ALLUMINIO VERNICIATO A POLVERE
- ACCESSORI IN OTTONE ABS CROMATO
- ATTACCO DOCCIA POSTERIORE

TRADITIONAL SHOWER

- SHOWER HEAD
- MIXER
- TIMED FOOTWASHER TAP • DIVERTER • 3 NEBULIZERS
- MADE OF POWDER COATED ALUMINIUM
- ACCESSORIES IN CHROMED BRASS AND CHROMED ABS
- REAR SHOWER ATTACHMENT

DOUCHE TRADITIONNELLE

- POMME DE DOUCHE
- MITIGEUR
- RINCE PIEDS TEMPORISÉ • DÉVIEUR • 3 NÉBULISEURS
- FABRIQUÉE EN ALUMINIUM PEINT EN POUDRE
- ACCESSOIRES EN LAITON CHROMÉ ET ABS
- RACCORDEMENT DE DOUCHE ARRIÈRE

DUCHA TRADITIONAL

- CABEZA DE DUCHA
- MEZCLADOR
- LAVAPIES TEMPORIZADO • DEVIATORE • 3 NEBULIZADORES
- REALIZADA EN ALUMINIO PINTADO EN POLVO
- ACCESORIOS DE LATÓN CROMADO Y ABS CROMO
- ACCESORIO DE DUCHA TRASERA





**TRADITIONAL
SHOWERS**

**ALLUMINIUM
QUICK**



PICCOLE DIMENSIONI PER UNA GRANDE DOCCIA

SMALL SIZE FOR A BIG SHOWER



Packaging di dimensioni ridotte con maniglia, trasportabili in auto, installazione e manutenzione semplici, misure palletizzabili su europallet.

Un prodotto in linea delle nuove direttive per riduzione consumi energetici riciclo dei materiali, bassi costi di trasporto, la risposta perfetta alla nuove esigenze del mercato distributivo e del consumatore.



Reduced packaging dimensions with handles, transportable by car, simple installation, maintenance and palletizable on europallets.

A product in line with the new directives for reducing energy consumption, recycling materials and low transport costs. The perfect response to the new needs of the distribution market and user.



Packaging de dimensions réduites avec poignée, transportable en voiture, installation et maintenance simple, paletisation sur europalettes.

Un produit conforme aux nouvelles directives de réduction de la consommation d'énergie, de recyclage des matériaux, de faibles coûts de transport, la réponse parfaite aux nouveaux besoins du marché de la distribution et du utilisateur.



Embalaje de reducidas dimensiones con asa, transportable en coche, instalación y mantenimiento simple, paletizable sobre europalets.

Un producto en línea con las nuevas directivas de reducción del consumo energético, reciclaje de materiales, bajos costes de transporte, la respuesta perfecta a las nuevas necesidades del mercado de la distribución y del usuario.



L'INNOVAZIONE DELLA QUICK FOTOVOLTAICA

THE INNOVATION OF THE PHOTOVOLTAIC QUICK



Il potenziale di questi modelli è avere la possibilità di installare la doccia in un luogo chiuso, ad esempio, si può montare all'interno delle cabine delle spiagge, e posizionando il pannello fotovoltaico all'esterno, si avrà il corretto funzionamento della luce a led.

La lampadina è da 12 volt, facilmente reperibile in commercio.



The potential of these models is to be able to install the shower in an enclosed location, for example, it can be mounted inside beach cabins, and by placing the photovoltaic panel outside, the LED light will work properly.

The bulb is a 12-volt bulb that is readily available on the market.



Le potentiel de ces modèles réside dans la possibilité d'installer la douche dans un endroit fermé, par exemple à l'intérieur d'une cabine de plage. Par exemple, elle peut être installée à l'intérieur de cabines de plage, et en plaçant le panneau photovoltaïque à l'extérieur, la lumière LED fonctionnera correctement.

L'ampoule est une ampoule de 12 volts que l'on trouve facilement sur le marché.



El potencial de estos modelos es poder instalar la ducha en un lugar cerrado, por ejemplo ejemplo, se puede montar en el interior de cabinas de playa, y colocando el panel fotovoltaico en el exterior, la luz LED funcionará correctamente.

La bombilla es de 12 voltios y se encuentra fácilmente en el mercado.



COLORS

STANDARD COLORS QUICK

			
BIANCO Bianco Lucido Glossy White 9003-QL	ALLUMINIO Alluminio Satinato Satin Aluminium 9007-QL	ARDESIA Ardesia Opaco Matt Slate 7015-QL	OTTANIO Ottanio Lucido Metallizzato Teal Shiny Metallic 5021-QL

SPECIAL COLORS QUICK

		
ONICE AMBRATO Onice Nero/Oro Amber Onyx Black/Gold M001	CARRARA Marmo Bianco White Marble M002	CARBONIO Carbonio Nero/Verde Green/Black Corbon C001

*EXTRA FOR SPECIAL COLORS

€

QUICK Q105

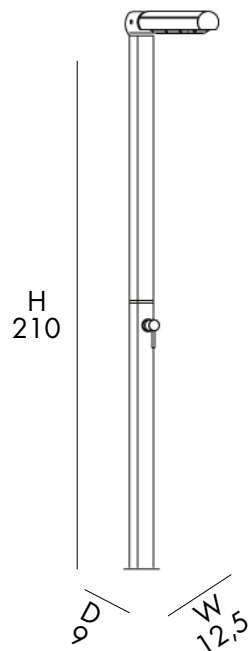

 8 Kg

 D 55 cm
H 11 cm
W 120 cm

DOCCIA TRADIZIONALE

- SOFFIONE
- MISCELATORE
- REALIZZATA IN ALLUMINIO VERNICIATO
- ACCESSORI IN OTTONE ABS CROMATO
- ATTACCO DOCCIA STANDARD A PAVIMENTO E/O LATERALE

TRADITIONAL SHOWER

- SHOWER HEAD
- MIXER
- MADE IN PAINTED ALUMINIUM
- ACCESSORIES IN CHROMED BRASS AND CHROMED ABS
- STANDARD FLOOR SHOWER ATTACHMENT AND/OR LATERAL

DOUCHE TRADITIONNELLE

- POMME DE DOUCHE
- MITIGEUR
- FABRIQUÉE EN ALUMINIUM PEINT
- ACCESSOIRES EN LAITON CHROMÉ ET ABS
- RACCORD DE DOUCHE STANDARD AVEC PLANCHER ET/OU CÔTÉ

DUCHA TRADITIONAL

- CABEZA DE DUCHA
- MEZCLADOR
- REALIZADA EN ALUMINIO PINTADO
- ACCESORIOS DE LATÓN CROMADO Y ABS CROMO
- CONEXIÓN DUCHA ESTÁNDAR CON PISO Y/O LATERAL



COLORS

STANDARD COLORS QUICK

			
BIANCO Bianco Lucido Glossy White 9003-QL	ALLUMINIO Alluminio Satinato Satin Aluminium 9007-QL	ARDESIA Ardesia Opaca Matt Slate 7015-QL	OTTANIO Ottanio Lucido Metallizzato Teal Shiny Metallic 5021-QL

SPECIAL COLORS QUICK

		
ONICE AMBRATO Onice Nero/Oro Amber Onyx Black/Gold M001	CARRARA Marmo Bianco White Marble M002	CARBONIO Carbonio Nero/Verde Green/Black Corbon C001

*EXTRA FOR
SPECIAL COLORS



QUICK Q125

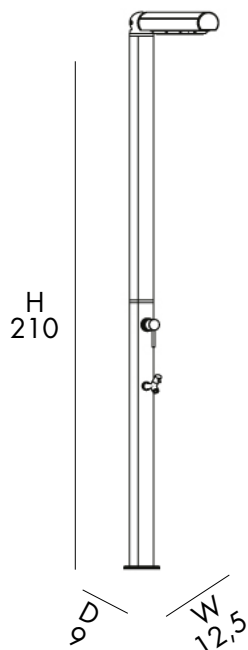

8,5 Kg



D 55 cm
H 11 cm
W 120 cm

DOCCIA TRADIZIONALE

- SOFFIONE
- MISCELATORE
- LAVAPIEDI
- REALIZZATA IN ALLUMINIO VERNICIATO
- ACCESSORI IN OTTONE ABS CROMATO
- ATTACCO DOCCIA STANDARD A PAVIMENTO E/O LATERALE



TRADITIONAL SHOWER

- SHOWER HEAD
- MIXER
- FOOTWASHER TAP
- MADE IN PAINTED ALUMINIUM
- ACCESSORIES IN CHROMED BRASS AND CHROMED ABS
- STANDARD FLOOR SHOWER ATTACHMENT AND/OR LATERAL

DOUCHE TRADITIONNELLE

- POMME DE DOUCHE
- MITIGEUR • RINCE PIEDS
- FABRIQUÉE EN ALUMINIUM PEINT
- ACCESSOIRES EN LAITON CHROMÉ ET ABS
- RACCORD DE DOUCHE STANDARD AVEC PLANCHER ET/OU CÔTÉ



DUCHA TRADITIONAL

- CABEZA DE DUCHA
- MEZCLADOR
- LAVAPIES
- REALIZADA EN ALUMINIO PINTADO
- ACCESORIOS DE LATÓN CROMADO Y ABS CROMO
- CONEXIÓN DUCHA ESTÁNDAR CON PISO Y/O LATERAL





COLORS

STANDARD COLORS QUICK

			
BIANCO Bianco Lucido Glossy White 9003-QL	ALLUMINIO Alluminio Satinato Satin Aluminium 9007-QL	ARDESIA Ardesia Opaco Matt Slate 7015-QL	OTTANIO Ottanio Lucido Metallizzato Teal Shiny Metallic 5021-QL

SPECIAL COLORS QUICK

		
ONICE AMBRATO Onice Nero/Oro Amber Onyx Black/Gold M001	CARRARA Marmo Bianco White Marble M002	CARBONIO Carbonio Nero/Verde Green/Black Corbon C001

*EXTRA FOR SPECIAL COLORS

€

QUICK Q145

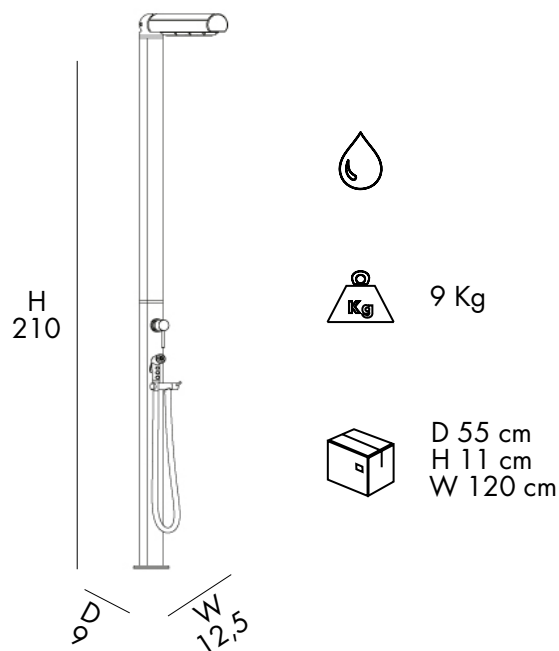

DOCCIA TRADIZIONALE

- SOFFIONE
- MISCELATORE
- DOCCETTA MOBILE
- REALIZZATA IN ALLUMINIO VERNICIATO
- ACCESSORI IN OTTONE ABS CROMATO
- ATTACCO DOCCIA STANDARD A PAVIMENTO E/O LATERALE

TRADITIONAL SHOWER

- SHOWER HEAD
- MIXER
- HAND SHOWER
- MADE IN PAINTED ALUMINIUM
- ACCESSORIES IN CHROMED BRASS AND CHROMED ABS
- STANDARD FLOOR SHOWER ATTACHMENT AND/OR LATERAL

DOUCHE TRADITIONNELLE

- POMME DE DOUCHE
- MITIGEUR • DOUCHETTE
- FABRIQUÉE EN ALUMINIUM PEINT
- ACCESSOIRES EN LAITON CHROMÉ ET ABS
- RACCORD DE DOUCHE STANDARD AVEC PLANCHER ET/OU CÔTÉ

DUCHA TRADITIONAL

- CABEZA DE DUCHA
- MEZCLADOR
- DOUCHA MOVIL
- REALIZADA EN ALUMINIO PINTADO
- ACCESORIOS DE LATÓN CROMADO Y ABS CROMO
- CONEXIÓN DUCHA ESTÁNDAR CON PISO Y/O LATERAL



COLORS

STANDARD COLORS QUICK

			
BIANCO Bianco Lucido Glossy White 9003-QL	ALLUMINIO Alluminio Satinato Satin Aluminium 9007-QL	ARDESIA Ardesia Opaca Matt Slate 7015-QL	OTTANIO Ottanio Lucido Metallizzato Teal Shiny Metallic 5021-QL

SPECIAL COLORS QUICK

		
ONICE AMBRATO Onice Nero/Oro Amber Onyx Black/Gold M001	CARRARA Marmo Bianco White Marble M002	CARBONIO Carbonio Nero/Verde Green/Black Corbon C001

*EXTRA FOR
SPECIAL COLORS



QUICK Q305

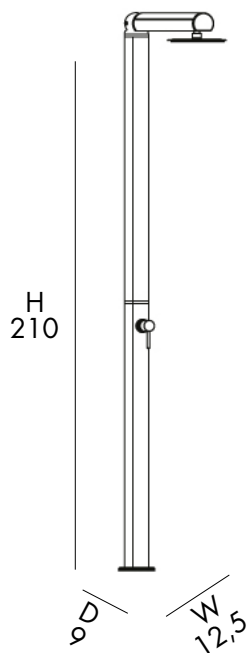

8 Kg



D 55 cm
H 11 cm
W 120 cm

DOCCIA TRADIZIONALE

- SOFFIONE 250mm
- MISCELATORE
- REALIZZATA IN ALLUMINIO VERNICIATO
- ACCESSORI IN OTTONE ABS CROMATO
- ATTACCO DOCCIA STANDARD A PAVIMENTO E/O LATERALE



TRADITIONAL SHOWER

- SHOWER HEAD 250mm
- MIXER
- MADE IN PAINTED ALUMINIUM
- ACCESSORIES IN CHROMED BRASS AND CHROMED ABS
- STANDARD FLOOR SHOWER ATTACHMENT AND/OR LATERAL

DOUCHE TRADITIONNELLE

- POMME DE DOUCHE 250mm
- MITIGEUR
- FABRIQUÉE EN ALUMINIUM PEINT
- ACCESSOIRES EN LAITON CHROMÉ ET ABS
- RACCORD DE DOUCHE STANDARD AVEC PLANCHER ET/OU CÔTÉ



DUCHA TRADITIONAL

- CABEZA DE DUCHA 250mm
- MEZCLADOR
- REALIZADA EN ALUMINIO PINTADO
- ACCESORIOS DE LATÓN CROMADO Y ABS CROMO
- CONEXIÓN DUCHA ESTÁNDAR CON PISO Y/O LATERAL





COLORS

STANDARD COLORS QUICK

			
BIANCO Bianco Lucido Glossy White 9003-QL	ALLUMINIO Alluminio Satinato Satin Aluminium 9007-QL	ARDESIA Ardesia Opaco Matt Slate 7015-QL	OTTANIO Ottanio Lucido Metallizzato Teal Shiny Metallic 5021-QL

SPECIAL COLORS QUICK

		
ONICE AMBRATO Onice Nero/Oro Amber Onyx Black/Gold M001	CARRARA Marmo Bianco White Marble M002	CARBONIO Carbonio Nero/Verde Green/Black Corbon C001

*EXTRA FOR
SPECIAL COLORS



QUICK Q325

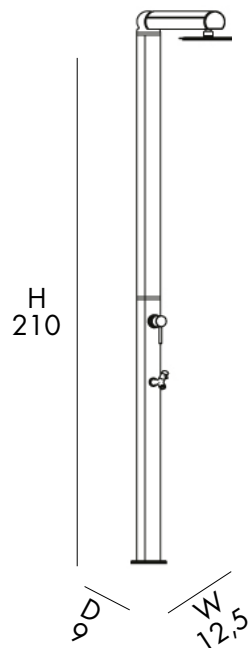

8,5 Kg



D 55 cm
H 11 cm
W 120 cm

DOCCIA TRADIZIONALE

- SOFFIONE 250mm
- MISCELATORE
- LAVAPIEDI
- REALIZZATA IN ALLUMINIO VERNICIATO
- ACCESSORI IN OTTONE ABS CROMATO
- ATTACCO DOCCIA STANDARD A PAVIMENTO E/O LATERALE



TRADITIONAL SHOWER

- SHOWER HEAD 250mm
- MIXER
- FOOTWASHER TAP
- MADE IN PAINTED ALUMINIUM
- ACCESSORIES IN CHROMED BRASS AND CHROMED ABS
- STANDARD FLOOR SHOWER ATTACHMENT AND/OR LATERAL

DOUCHE TRADITIONNELLE

- POMME DE DOUCHE 250mm
- MITIGEUR • RINCE PIEDS
- FABRIQUÉE EN ALUMINIUM PEINT
- ACCESSOIRES EN LAITON CHROMÉ ET ABS
- RACCORD DE DOUCHE STANDARD AVEC PLANCHER ET/OU CÔTÉ



DUCHA TRADITIONAL

- CABEZA DE DUCHA 250mm
- MEZCLADOR
- LAVAPIES
- REALIZADA EN ALUMINIO PINTADO
- ACCESORIOS DE LATÓN CROMADO Y ABS CROMO
- CONEXIÓN DUCHA ESTÁNDAR CON PISO Y/O LATERAL



COLORS

STANDARD COLORS QUICK

			
BIANCO Bianco Lucido Glossy White 9003-QL	ALLUMINIO Alluminio Satinato Satin Aluminium 9007-QL	ARDESIA Ardesia Opaca Matt Slate 7015-QL	OTTANIO Ottanio Lucido Metallizzato Teal Shiny Metallic 5021-QL

SPECIAL COLORS QUICK

		
ONICE AMBRATO Onice Nero/Oro Amber Onyx Black/Gold M001	CARRARA Marmo Bianco White Marble M002	CARBONIO Carbonio Nero/Verde Green/Black Corbon C001

*EXTRA FOR
SPECIAL COLORS

€

QUICK Q345

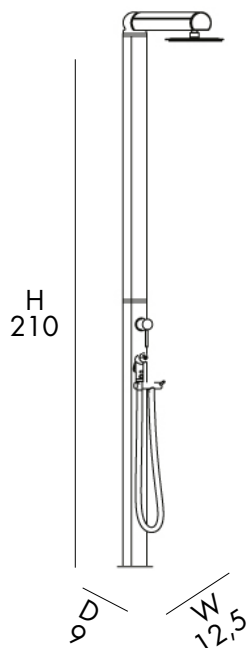

9 Kg



D 55 cm
H 11 cm
W 120 cm

DOCCIA TRADIZIONALE

- SOFFIONE 250mm
- MISCELATORE
- DOCCETTA MOBILE
- REALIZZATA IN ALLUMINIO VERNICIATO
- ACCESSORI IN OTTONE ABS CROMATO
- ATTACCO DOCCIA STANDARD A PAVIMENTO E/O LATERALE



TRADITIONAL SHOWER

- SHOWER HEAD 250mm
- MIXER
- HAND SHOWER
- MADE IN PAINTED ALUMINIUM
- ACCESSORIES IN CHROMED BRASS AND CHROMED ABS
- STANDARD FLOOR SHOWER ATTACHMENT AND/OR LATERAL

DOUCHE TRADITIONNELLE

- POMME DE DOUCHE 250mm
- MITIGEUR • DOUCHETTE
- FABRIQUÉE EN ALUMINIUM PEINT
- ACCESSOIRES EN LAITON CHROMÉ ET ABS
- RACCORD DE DOUCHE STANDARD AVEC PLANCHER ET/OU CÔTÉ



DUCHA TRADITIONAL

- CABEZA DE DUCHA 250mm
- MEZCLADOR
- DOUCHA MOVIL
- REALIZADA EN ALUMINIO PINTADO
- ACCESORIOS DE LATÓN CROMADO Y ABS CROMO
- CONEXIÓN DUCHA ESTÁNDAR CON PISO Y/O LATERAL



COLORS

STANDARD COLORS QUICK

 BIANCO Bianco Lucido Glossy White 9003-QL	 ALLUMINIO Alluminio Satinato Satin Aluminium 9007-QL	 ARDESIA Ardesia Opaco Matt Slate 7015-QL	 OTTANIO Ottanio Lucido Metallizzato Teal Shiny Metallic 5021-QL
---	--	--	---

SPECIAL COLORS QUICK

 ONICE AMBRATO Onice Nero/Oro Amber Onyx Black/Gold M001	 CARRARA Marmo Bianco White Marble M002	 CARBONIO Carbonio Nero/Verde Green/Black Corbon C001
---	--	--

*EXTRA FOR SPECIAL COLORS



QUICK Q805

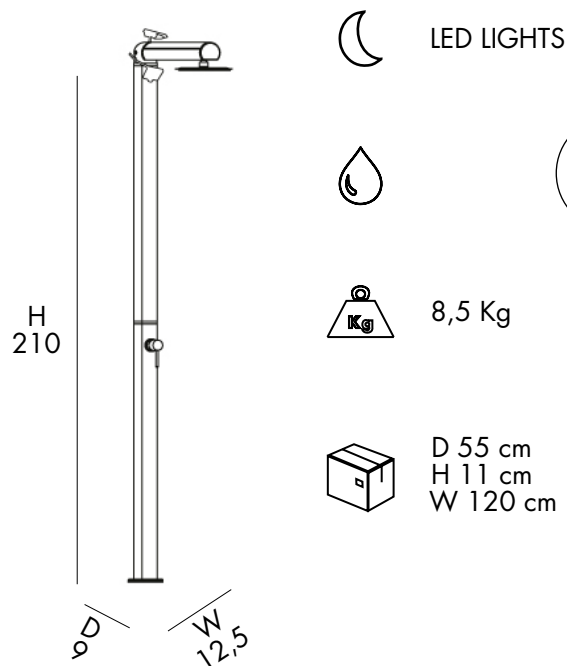

DOCCIA TRADIZIONALE con illuminazione

- SOFFIONE
- MISCELATORE
- REALIZZATA IN ALLUMINIO VERNICIATO
- ACCESSORI IN OTTONE ABS CROMATO
- LAMPADA FOTOVOLTAICA CON CREPUSCOLARE
- ATTACCO DOCCIA STANDARD A PAVIMENTO E/O LATERALE

TRADITIONAL SHOWER with lighting

- SHOWER HEAD
- MIXER
- MADE IN PAINTED ALUMINIUM
- ACCESSORIES IN CHROMED BRASS AND CHROMED ABS
- PHOTOVOLTAIC LAMP WITH TWILIGHT
- STANDARD FLOOR SHOWER ATTACHMENT AND/OR LATERAL

DOUCHE TRADITIONNELLE avec illumination

- POMME DE DOUCHE
- MITIGEUR
- FABRIQUÉE EN ALUMINIUM PEINT
- ACCESSOIRES EN LAITON CHROMÉ ET ABS
- LAMPE PHOTOVOLTAÏQUE AVEC CRÉPUSCULE
- RACCORD DE DOUCHE STANDARD AVEC PLANCHER ET/OU CÔTÉ

DUCHA TRADITIONAL con iluminación

- CABEZA DE DUCHA
- MEZCLADOR
- REALIZADA EN ALUMINIO PINTADO
- ACCESORIOS DE LATÓN CROMADO Y ABS CROMO
- LÁMPARA FOTOVOLTAICA CON CREPÚSCULO
- CONEXIÓN DUCHA ESTÁNDAR CON PISO Y/O LATERAL



COLORS

STANDARD COLORS QUICK

			
BIANCO Bianco Lucido Glossy White 9003-QL	ALLUMINIO Alluminio Satinato Satin Aluminium 9007-QL	ARDESIA Ardesia Opaca Matt Slate 7015-QL	OTTANIO Ottanio Lucido Metallizzato Teal Shiny Metallic 5021-QL

SPECIAL COLORS QUICK

		
ONICE AMBRATO Onice Nero/Oro Amber Onyx Black/Gold M001	CARRARA Marmo Bianco White Marble M002	CARBONIO Carbonio Nero/Verde Green/Black Corbon C001

*EXTRA FOR
SPECIAL COLORS

€

QUICK Q825

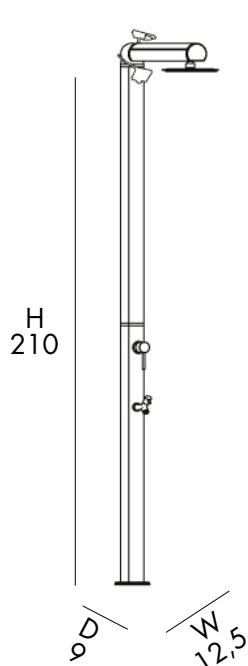

LED LIGHTS



9 Kg



D 55 cm
H 11 cm
W 120 cm

DOCCIA TRADIZIONALE con illuminazione

- SOFFIONE
- MISCELATORE • LAVAPIEDI
- REALIZZATA IN ALLUMINIO VERNICIATO
- ACCESSORI IN OTTONE ABS CROMATO
- LAMPADA FOTOVOLTAICA CON CREPUSCOLARE
- ATTACCO DOCCIA STANDARD A PAVIMENTO E/O LATERALE



TRADITIONAL SHOWER with lighting

- SHOWER HEAD
- MIXER • FOOTWASHER TAP
- MADE IN PAINTED ALUMINIUM
- ACCESSORIES IN CHROMED BRASS AND CHROMED ABS
- PHOTOVOLTAIC LAMP WITH TWILIGHT
- STANDARD FLOOR SHOWER ATTACHMENT AND/OR LATERAL

DOUCHE TRADITIONNELLE avec illumination

- POMME DE DOUCHE
- MITIGEUR • RINCE PIEDS
- FABRIQUÉE EN ALUMINIUM PEINT
- ACCESSOIRES EN LAITON CHROMÉ ET ABS
- LAMPE PHOTOVOLTAÏQUE AVEC CRÉPUSCULE
- RACCORD DE DOUCHE STANDARD AVEC PLANCHER ET/OU CÔTÉ

DUCHA TRADITIONAL con iluminación

- CABEZA DE DUCHA
- MEZCLADOR • LAVAPIES
- REALIZADA EN ALUMINIO PINTADO
- ACCESORIOS DE LATÓN CROMADO Y ABS CROMO
- LÁMPARA FOTOVOLTAICA CON CREPÚSCULO
- CONEXIÓN DUCHA ESTÁNDAR CON PISO Y/O LATERAL



COLORS

STANDARD COLORS QUICK

			
BIANCO Bianco Lucido Glossy White 9003-QL	ALLUMINIO Alluminio Satinato Satin Aluminium 9007-QL	ARDESIA Ardesia Opaco Matt Slate 7015-QL	OTTANIO Ottanio Lucido Metallizzato Teal Shiny Metallic 5021-QL

SPECIAL COLORS QUICK

		
ONICE AMBRATO Onice Nero/Oro Amber Onyx Black/Gold M001	CARRARA Marmo Bianco White Marble M002	CARBONIO Carbonio Nero/Verde Green/Black Corbon C001

*EXTRA FOR SPECIAL COLORS



QUICK Q845

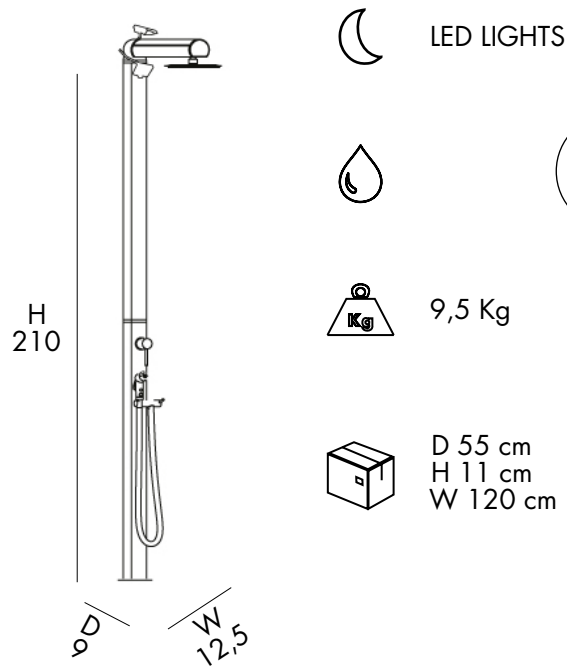

DOCCIA TRADIZIONALE con illuminazione

- SOFFIONE
- MISCELATORE • DOCCETTA MOBILE
- REALIZZATA IN ALLUMINIO VERNICIATO
- ACCESSORI IN OTTONE ABS CROMATO
- LAMPADA FOTOVOLTAICA CON CREPUSCOLARE
- ATTACCO DOCCIA STANDARD A PAVIMENTO E/O LATERALE

TRADITIONAL SHOWER with lighting

- SHOWER HEAD
- MIXER • HAND SHOWER
- MADE IN PAINTED ALUMINIUM
- ACCESSORIES IN CHROMED BRASS AND CHROMED ABS
- PHOTOVOLTAIC LAMP WITH TWILIGHT
- STANDARD FLOOR SHOWER ATTACHMENT AND/OR LATERAL

DOUCHE TRADITIONNELLE avec illumination

- POMME DE DOUCHE
- MITIGEUR • DOUCHETTE
- FABRIQUÉE EN ALUMINIUM PEINT
- ACCESSOIRES EN LAITON CHROMÉ ET ABS
- LAMPE PHOTOVOLTAÏQUE AVEC CRÉPUSCULE
- RACCORD DE DOUCHE STANDARD AVEC PLANCHER ET/OU CÔTÉ

DUCHA TRADITIONAL con iluminación

- CABEZA DE DUCHA
- MEZCLADOR • DOUCHA MOVIL
- REALIZADA EN ALUMINIO PINTADO
- ACCESORIOS DE LATÓN CROMADO Y ABS CROMO
- LÁMPARA FOTOVOLTAICA CON CREPÚSCULO
- CONEXIÓN DUCHA ESTÁNDAR CON PISO Y/O LATERAL



COLORS

STANDARD COLORS QUICK

			
BIANCO Bianco Lucido Glossy White 9003-QL	ALLUMINIO Alluminio Satinato Satin Aluminium 9007-QL	ARDESIA Ardesia Opaca Matt Slate 7015-QL	OTTANIO Ottanio Lucido Metallizzato Teal Shiny Metallic 5021-QL

SPECIAL COLORS QUICK

		
ONICE AMBRATO Onice Nero/Oro Amber Onyx Black/Gold M001	CARRARA Marmo Bianco White Marble M002	CARBONIO Carbonio Nero/Verde Green/Black Corbon C001

*EXTRA FOR
SPECIAL COLORS

€

QUICK Q105-F

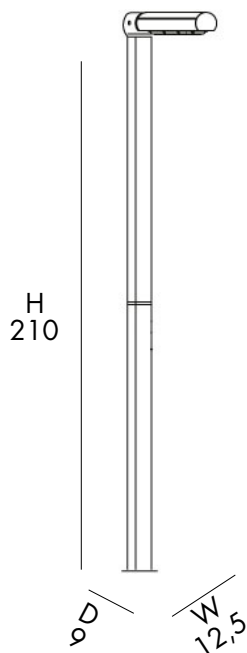

8 Kg



D 55 cm
H 11 cm
W 120 cm

DOCCIA TRADIZIONALE

- SOLO ACQUA FREDDA/COMPATIBILE CON TORRETTA A PAGAMENTO
- SOFFIONE
- REALIZZATA IN ALLUMINIO VERNICIATO
- ACCESSORI IN OTTONE ABS CROMATO
- ATTACCO DOCCIA STANDARD A PAVIMENTO E/O LATERALE



TRADITIONAL SHOWER

- COLD WATER ONLY/COMPATIBLE WITH TURRET FOR A FEE
- SHOWER HEAD
- MADE IN PAINTED ALUMINIUM
- ACCESSORIES IN CHROMED BRASS AND CHROMED ABS
- STANDARD FLOOR SHOWER ATTACHMENT AND/OR LATERAL

DOUCHE TRADITIONNELLE

- EAU FROIDE UNIQUEMENT/COMPATIBLE AVEC LA TOURELLE MOYENNANT UN SUPPLÉMENT
- POMME DE DOUCHE
- FABRIQUÉE EN ALUMINIUM PEINT
- ACCESSOIRES EN LAITON CHROMÉ ET ABS
- RACCORD DE DOUCHE STANDARD AVEC PLANCHER ET/OU CÔTÉ

DUCHA TRADITIONAL

- SÓLO AGUA FRÍA/COMPATIBLE CON TORRETA POR UN SUPLEMENTO
- CABEZA DE DUCHA
- REALIZADA EN ALUMINIO PINTADO
- ACCESORIOS DE LATÓN CROMADO Y ABS CROMO
- CONEXIÓN DUCHA ESTÁNDAR CON PISO Y/O LATERAL



COLORS

STANDARD COLORS QUICK

			
BIANCO Bianco Lucido Glossy White 9003-QL	ALLUMINIO Alluminio Satinato Satin Aluminium 9007-QL	ARDESIA Ardesia Opaco Matt Slate 7015-QL	OTTANIO Ottanio Lucido Metallizzato Teal Shiny Metallic 5021-QL

SPECIAL COLORS QUICK

		
ONICE AMBRATO Onice Nero/Oro Amber Onyx Black/Gold M001	CARRARA Marmo Bianco White Marble M002	CARBONIO Carbonio Nero/Verde Green/Black Corbon C001

*EXTRA FOR SPECIAL COLORS

€

QUICK Q305-F

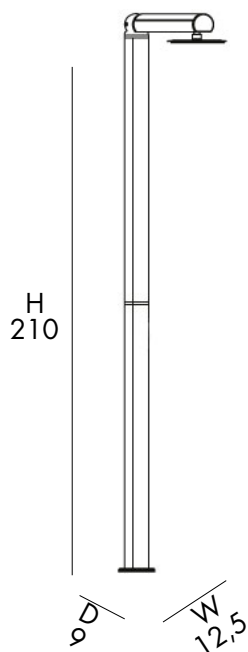

8 Kg



D 55 cm
H 11 cm
W 120 cm

DOCCIA TRADIZIONALE

- SOLO ACQUA FREDDA/COMPATIBILE CON TORRETTA A PAGAMENTO
- SOFFIONE 250mm
- REALIZZATA IN ALLUMINIO VERNICIATO
- ACCESSORI IN OTTONE ABS CROMATO
- ATTACCO DOCCIA STANDARD A PAVIMENTO E/O LATERALE



TRADITIONAL SHOWER

- COLD WATER ONLY/COMPATIBLE WITH PAYMENT STATION
- SHOWER HEAD 250mm
- MADE IN PAINTED ALUMINIUM
- ACCESSORIES IN CHROMED BRASS AND CHROMED ABS
- STANDARD FLOOR SHOWER ATTACHMENT AND/OR LATERAL

DOUCHE TRADITIONNELLE

- EAU FROIDE UNIQUEMENT/COMPATIBLE AVEC LA TOURELLE MOYENNANT UN SUPPLÉMENT
- POMME DE DOUCHE 250mm
- FABRIQUÉE EN ALUMINIUM PEINT
- ACCESSOIRES EN LAITON CHROMÉ ET ABS
- RACCORD DE DOUCHE STANDARD AVEC PLANCHER ET/OU CÔTÉ

DUCHA TRADITIONAL

- SÓLO AGUA FRÍA/COMPATIBLE CON TORRETA POR UN SUPLEMENTO
- CABEZA DE DUCHA 250mm
- REALIZADA EN ALUMINIO PINTADO
- ACCESORIOS DE LATÓN CROMADO Y ABS CROMO
- CONEXIÓN DUCHA ESTÁNDAR CON PISO Y/O LATERAL



COLORS

STANDARD COLORS QUICK

			
BIANCO Bianco Lucido Glossy White 9003-QL	ALLUMINIO Alluminio Satinato Satin Aluminium 9007-QL	ARDESIA Ardesia Opaca Matt Slate 7015-QL	OTTANIO Ottanio Lucido Metallizzato Teal Shiny Metallic 5021-QL

SPECIAL COLORS QUICK

		
ONICE AMBRATO Onice Nero/Oro Amber Onyx Black/Gold M001	CARRARA Marmo Bianco White Marble M002	CARBONIO Carbonio Nero/Verde Green/Black Corbon C001

*EXTRA FOR
SPECIAL COLORS



QUICK Q695

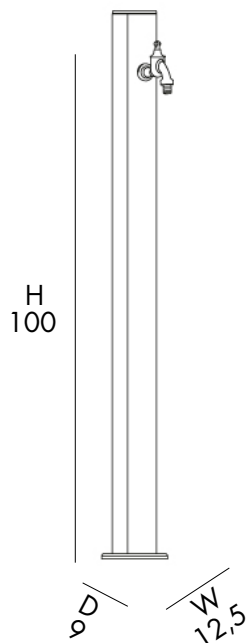

3 Kg



D 11 cm
H 15 cm
W 105 cm



Accessorio compatibile
SECCHIO
(resina PE HD)
Cod. D200
(non incluso/not included)

FONTANA TRADIZIONALE

- RUBINETTO PORTA GOMME ACQUA FREDDA
- REALIZZATA IN ALLUMINIO VERNICIATO
- ACCESSORI IN OTTONE ABS CROMATO
- ATTACCO DOCCIA STANDARD A PAVIMENTO E/O LATERALE



TRADITIONAL FOUNTAIN

- COLD WATER GARDEN TAP
- MADE IN PAINTED ALUMINIUM
- ACCESSORIES IN CHROMED BRASS AND CHROMED ABS
- STANDARD FLOOR SHOWER ATTACHMENT AND/OR LATERAL

FONTAINE TRADITIONNELLE

- ROBINET TUYAU À EAU FROIDE
- FABRIQUÉE EN ALUMINIUM PEINT
- ACCESSOIRES EN LAITON CHROMÉ ET ABS
- RACCORD DE DOUCHE STANDARD AVEC PLANCHER ET/OU CÔTÉ



FUENTE TRADITIONAL

- GRIFO DE MANGUERA DE AGUA FRÍA
- REALIZADA EN ALUMINIO PINTADO
- ACCESORIOS DE LATÓN CROMADO Y ABS CROMO
- CONEXIÓN DUCHA ESTÁNDAR CON PISO Y/O LATERAL





COLORS

STANDARD COLORS QUICK

			
BIANCO Bianco Lucido Glossy White 9003-QL	ALLUMINIO Alluminio Satinato Satin Aluminium 9007-QL	ARDESIA Ardesia Opaco Matt Slate 7015-QL	OTTANIO Ottanio Lucido Metallizzato Teal Shiny Metallic 5021-QL

SPECIAL COLORS QUICK

		
ONICE AMBRATO Onice Nero/Oro Amber Onyx Black/Gold M001	CARRARA Marmo Bianco White Marble M002	CARBONIO Carbonio Nero/Verde Green/Black Corbon C001

*EXTRA FOR
SPECIAL COLORS



QUICK Q645

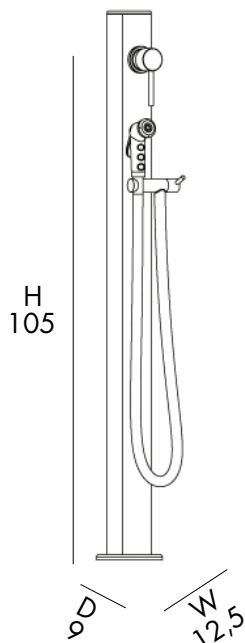

4 Kg



D 11 cm
H 15 cm
W 105 cm

FONTANA TRADIZIONALE

- MISCELATORE
- DOCCETTA ACQUA FREDDA
- REALIZZATA IN ALLUMINIO VERNICIATO
- ACCESSORI IN OTTONE ABS CROMATO
- ATTACCO DOCCIA STANDARD A PAVIMENTO E/O LATERALE

TRADITIONAL FOUNTAIN

- MIXER
- COLD WATER HAND SHOWER
- MADE IN PAINTED ALUMINIUM
- ACCESSORIES IN CHROMED BRASS AND CHROMED ABS
- STANDARD FLOOR SHOWER ATTACHMENT AND/OR LATERAL

FONTAINE TRADITIONNELLE

- MITIGEUR
- DOUCHETTE À EAU FROIDE
- FABRIQUÉE EN ALUMINIUM PEINT
- ACCESSOIRES EN LAITON CHROMÉ ET ABS
- RACCORD DE DOUCHE STANDARD AVEC PLANCHER ET/OU CÔTÉ

FUENTE TRADITIONAL

- MEZCLADOR
- DOUCHA MOVIL DE AGUA FRÍA
- REALIZADA EN ALUMINIO PINTADO
- ACCESORIOS DE LATÓN CROMADO Y ABS CROMO
- CONEXIÓN DUCHA ESTÁNDAR CON PISO Y/O LATERAL



COLORS

STANDARD COLORS QUICK

			
BIANCO Bianco Lucido Glossy White 9003-QL	ALLUMINIO Alluminio Satinato Satin Aluminium 9007-QL	ARDESIA Ardesia Opaca Matt Slate 7015-QL	OTTANIO Ottanio Lucido Metallizzato Teal Shiny Metallic 5021-QL

SPECIAL COLORS QUICK

		
ONICE AMBRATO Onice Nero/Oro Amber Onyx Black/Gold M001	CARRARA Marmo Bianco White Marble M002	CARBONIO Carbonio Nero/Verde Green/Black Corbon C001

*EXTRA FOR
SPECIAL COLORS



QUICK Q655

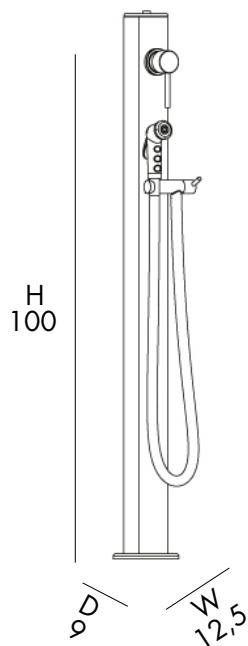

5 Kg



D 11 cm
H 15 cm
W 105 cm

FONTANA TRADIZIONALE

- MISCELATORE
- DOCCETTA ACQUA FREDDA
- NEBULIZZATORE
- REALIZZATA IN ALLUMINIO VERNICIATO
- ACCESSORI IN OTTONE ABS CROMATO
- ATTACCO DOCCIA STANDARD A PAVIMENTO E/O LATERALE



TRADITIONAL FOUNTAIN

- MIXER
- COLD WATER HAND SHOWER
- NEBULIZER
- MADE IN PAINTED ALUMINIUM
- ACCESSORIES IN CHROMED BRASS AND CHROMED ABS
- STANDARD FLOOR SHOWER ATTACHMENT AND/OR LATERAL

FONTAINE TRADITIONNELLE

- MITIGEUR
- DOUCHETTE À EAU FROIDE
- NÉBULISATEUR
- FABRIQUÉE EN ALUMINIUM PEINT
- ACCESSOIRES EN LAITON CHROMÉ ET ABS
- RACCORD DE DOUCHE STANDARD AVEC PLANCHER ET/OU CÔTÉ

FUENTE TRADITIONAL

- MEZCLADOR
- DOUCHA MOVIL DE AGUA FRÍA
- NEBULIZADOR
- REALIZADA EN ALUMINIO PINTADO
- ACCESORIOS DE LATÓN CROMADO Y ABS CROMO
- CONEXIÓN DUCHA ESTÁNDAR CON PISO Y/O LATERAL



STANDARD COLORS QUICK



BIANCO
 Bianco Lucido
 Glossy White
 9003-QL

SANITY GATE QG900

PROFESSIONAL LINE

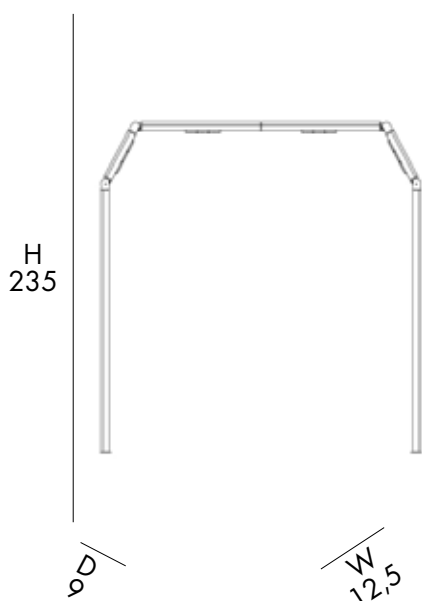

20 Kg



SANITY GATE

- REALIZZATA IN ALLUMINIO VERNICIATO
- ACCESSORI IN OTTONE ABS CROMATO
- RUBINETTO DI CHIUSURA RACCORDI DA 1/2
- SOFFIONI ORIENTABILI
- SOLO ACQUA FREDDA

SANITY GATE

- MADE IN PAINTED ALUMINIUM
- ACCESSORIES IN CHROMED BRASS AND CHROMED ABS
- 1/2 INCH WATER INLET
- ADJUSTABLE HEADS
- COLD WATER ONLY

SANITY GATE

- FABRIQUÉE EN ALUMINIUM PEINT
- ACCESSOIRES EN LAITON CHROMÉ ET ABS
- 1/2 ROBINET D'ARRÊT
- TÊTES RÉGLABLES
- EAU FROIDE UNIQUEMENT

SANITY GATE

- REALIZADA EN ALUMINIO PINTADO
- ACCESORIOS DE LATÓN CROMADO Y ABS CROMO
- GRIFO DE CIERRE DE 1/2 RACOR
- CABEZAS AJUSTABLES
- SÓLO AGUA FRÍA



STANDARD COLORS QUICK

 BIANCO
 Bianco Lucido
 Glossy White
 9003-QL

COLONNA FOTOCELLULA QM970

PROFESSIONAL LINE

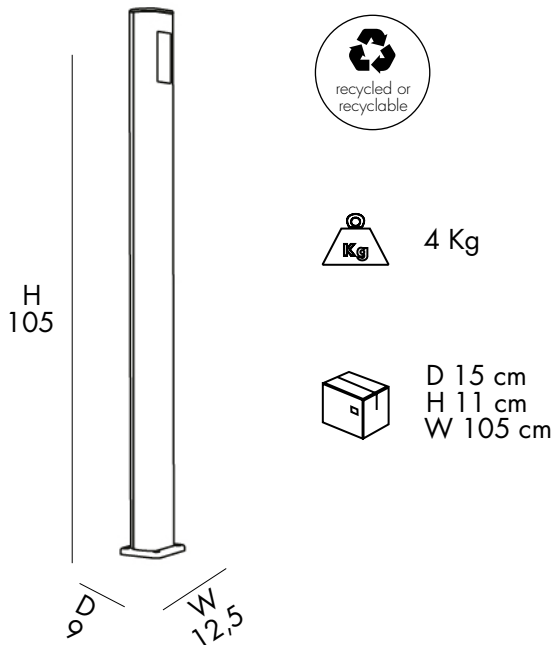

COLONNA FOTOCELLULA

- REALIZZATA IN ALLUMINIO VERNICIATO
- ELETTROVALVOLA COMANDO A BATTERIA
- SOLO ACQUA FREDDA

PHOTOCELL COLUMN

- MADE IN PAINTED ALUMINIUM
- BATTERY OPERATED SOLENOID VALVE
- COLD-ONLY

COLONNE PHOTOCELLULE

- FABRIQUÉE EN ALUMINIUM PEINT
- ÉLECTROVANNE DE COMMANDE DE BOBINE
- FROIDE UNIQUEMENT

COLUMNA FOTOCÉLULA

- REALIZADA EN ALUMINIO PINTADO
- ELECTROVÁLVULA DE CONTROL DE BOBINA
- SOLO EN FRÍO

COLONNA FOTOCELLULA QM980

PROFESSIONAL LINE

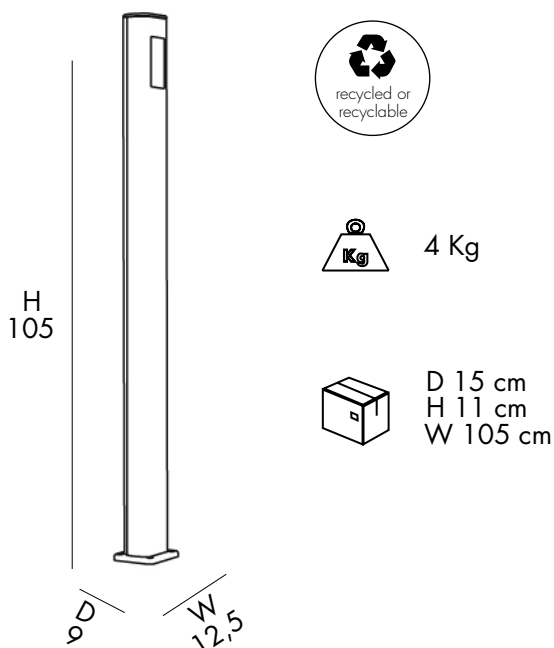

COLONNA FOTOCELLULA

- REALIZZATA IN ALLUMINIO VERNICIATO
- ELETTROVALVOLA E TERMOSTATICO COMANDO A BATTERIA CALDA E FREDDA
- COLONNA FOTOCELLULA E REGOLATORE TERMOSTATICO

COLONNE PHOTOCELLULE

- MADE IN PAINTED ALUMINIUM
- SOLENOID VALVE, BATTERY OPERATED, AND HOT AND COLD THERMOSTATIC
- PHOTOCELL COLUMN AND THERMOSTATIC REGULATOR

COLUMNA FOTOCÉLULA

- FABRIQUÉE EN ALUMINIUM PEINT
- ÉLECTROVANNE, À PILES ET THERMOSTATIQUE CHAUD ET FROID
- COLONNE PHOTOCELLULE ET RÉGULATEUR THERMOSTATIQUE

DUCHA TRADITIONAL

- REALIZADA EN ALUMINIO PINTADO
- ELECTROVÁLVULA, A PILAS Y TERMOSTÁTICA DE FRÍA Y CALIENTE
- COLUMNA DE FOTOCÉLULAS Y REGULADOR TERMOSTÁTICO

SPECIFICHE TECNICHE: DOCCIA QUICK

TECHNICAL SPECS: QUICK SHOWER

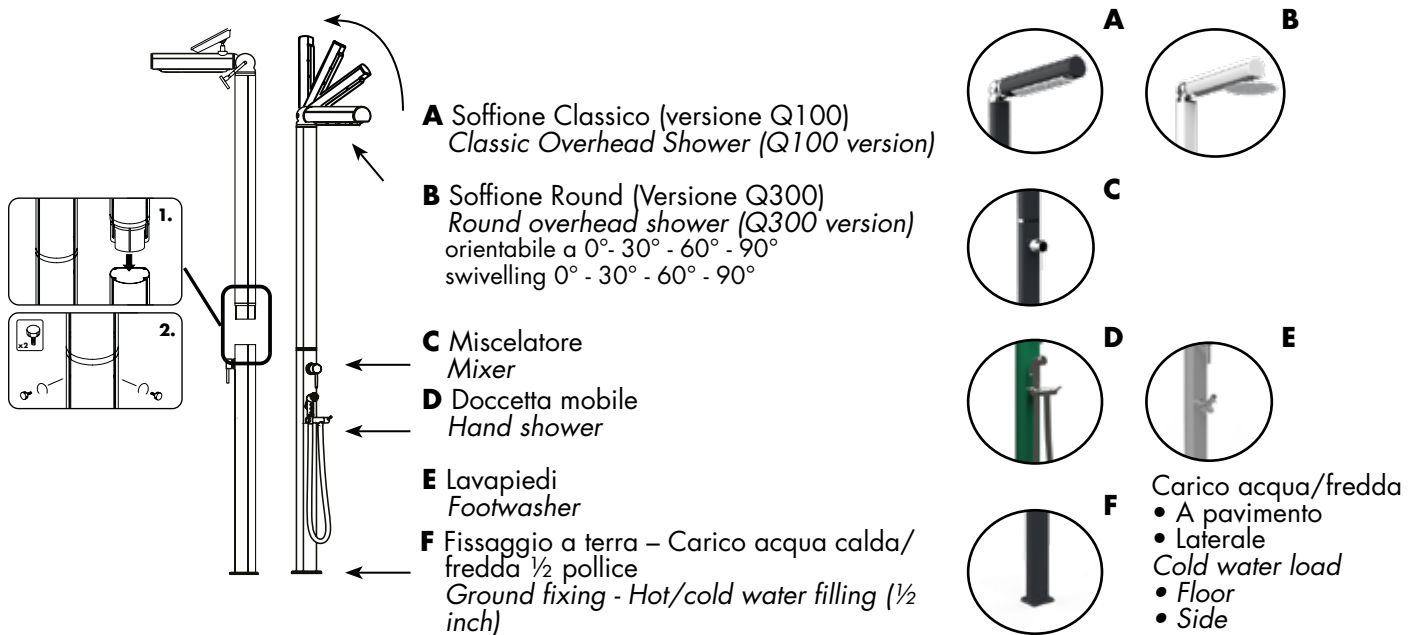

DOCCIA TRADIZIONALE CON INGRESSO ACQUA CALDA / ACQUA FREDDA

Idonea ad ambientazioni sia interne che esterne, realizzate in alluminio verniciato / disponibile in 4 colori, gli accessori sono in ottone cromato. Di facile installazione, non occorrono specifiche competenze. Prodotta in 6 configurazioni DOCCIA:

- Q105 mixer / Q305 + soffione 250 mm
- Q125 mixer e lavapiedi / Q325 + soffione 250 mm
- Q145 mixer e doccetta mobile / Q345 + soffione 250



TRADITIONAL SHOWER WITH HOT / COLD WATER INLET

Suitable for both indoor and outdoor settings. Made of liquid painted aluminum and available in 4 colors, accessories in chromed brass. Easy to install, no specific skills are required. Produced in 6 SHOWER configurations:

- Q105 mixer / Q305 + 250 mm shower head
- Q125 mixer and foot washer / Q325 + 250 mm shower head
- Q145 mixer and hand shower / Q345 + 250 mm shower head



DOUCHE TRADITIONNELLE AVEC ENTRÉE D'EAU CHAUDE / FROIDE

Appropriée pour les environnements intérieurs et extérieurs, réalisée en aluminium peint / disponible en 4 couleurs, accessoires en laiton chromé. Facile à installer, de compétences spécifiques. Produit en 6 configurations DOUCHE:

- Q105 mixer / Q305 + pomme de douche 250 mm
- Q125 mélangeur et lave-pieds / Q325 + pomme de douche 250 mm
- Q145 mélangeur et douche mobile / Q345 + pomme de douche 250 mm



DUCHA TRADICIONAL CON ENTRADA DE AGUA CALIENTE / FRÍA

Es apto para uso en interiores y exteriores, de aluminio pintado / disponible en 4 colores, accesorios de latón cromado. Fácil de instalar, sin necesidad de conocimientos especiales. Disponible en 6 configuraciones de DUCHA:

- Q105 mezclador / Q305 + cabezal de ducha 250 mm
- Q125 mezclador y ducha de pie / Q325 + ducha mural 250 mm
- Q145 mezclador y ducha de mano / Q345 + ducha mural 250 mm

SPECIFICHE TECNICHE: FONTANA QUICK

TECHNICAL SPECS: QUICK FOUNTAIN

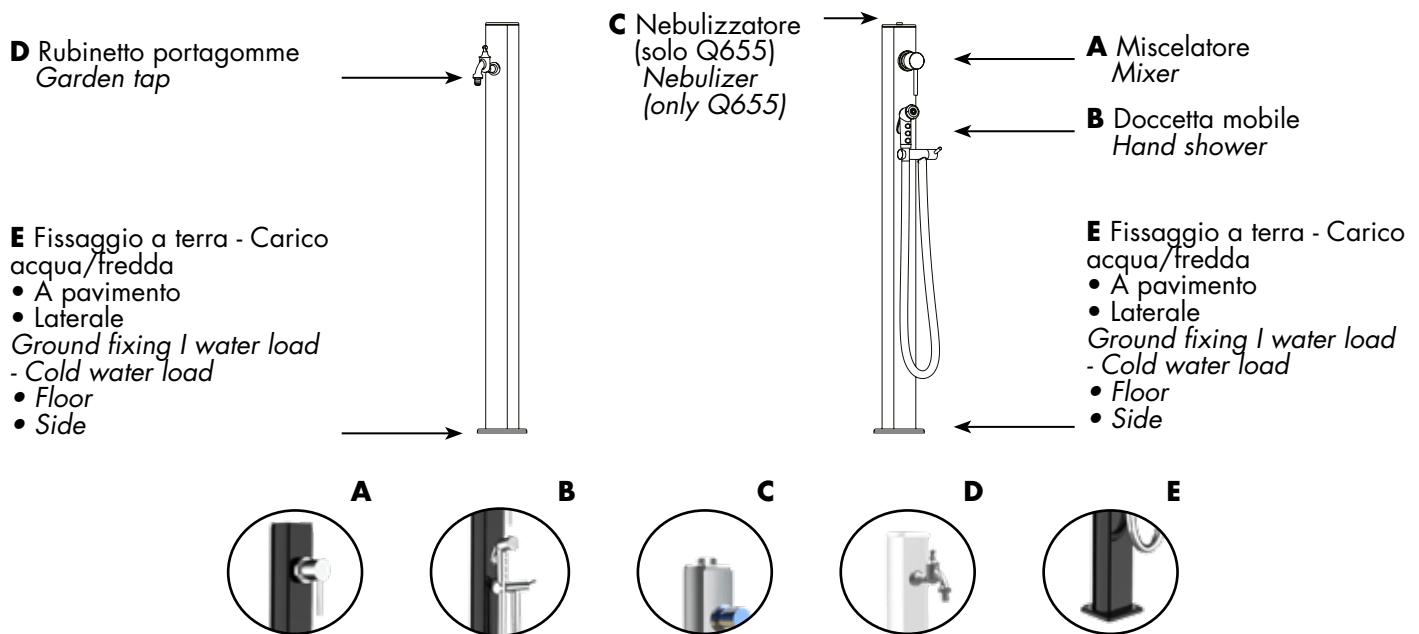

FONTANA TRADIZIONALE CON INGRESSO ACQUA CALDA / ACQUA FREDDA

Idonea ad ambientazioni sia interne che esterne, realizzate in alluminio verniciato / disponibile in 4 colori, gli accessori sono in ottone cromato. Di facile installazione, non occorrono specifiche competenze. Prodotta in 3 configurazioni SMART:

- Q695 rubinetto porta gomme
- Q645 mixer - doccetta mobile
- Q655 mixer - doccetta mobile – nebulizzatore



TRADITIONAL FOUNTAIN WITH HOT / COLD WATER INLET

Suitable for both indoor and outdoor settings. Made of liquid painted aluminum and available in 4 colors accessories in chromed brass. Easy to install, no specific skills are required. Produced in 3 SMART configurations:

- Q695 tire garden tap
- Q645 mixer - hand shower
- Q655 mixer - hand shower – nebulizer



FONTAINE TRADITIONNELLE AVEC ENTRÉE D'EAU CHAUDE / FROIDE

Appropriée pour les environnements intérieurs et extérieurs, réalisée en aluminium peint / disponible en 4 couleurs, accessoires en laiton chromé. Facile à installer, de compétences spécifiques. Produit en 3 configurations SMART:

- Q695 porte-tuyau
- Q645 mixer - douche mobile
- Q655 mixer - douche mobile – nébuliseur



FUENTE TRADICIONAL CON ENTRADA DE AGUA CALIENTE / FRÍA

Es apto para uso en interiores y exteriores, de aluminio pintado / disponible en 4 colores, accesorios de latón cromado. Fácil de instalar, sin necesidad de conocimientos especiales. Disponible en 6 configuraciones de SMART:

- Q695 manguera de jardín
- Q645 mezclador - ducha de mano
- Q655 mezclador - ducha de swivelling 0° - 30° - 60° - 90° mano – nebulizador

SPECIFICHE TECNICHE: SANITY GATE

TECHNICAL SPECS: SANITY GATE

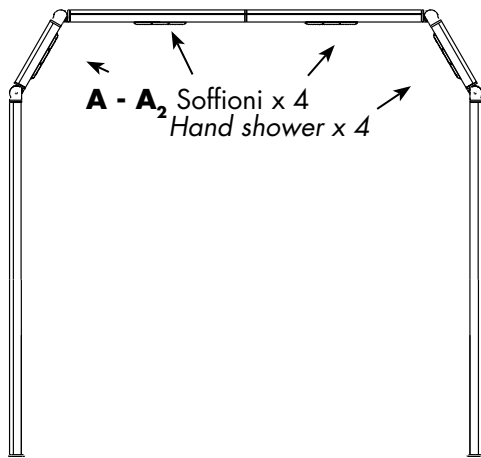

B Fissaggio a terra -
Carico acqua/fredda
Ground fixing / water load -
Cold water load

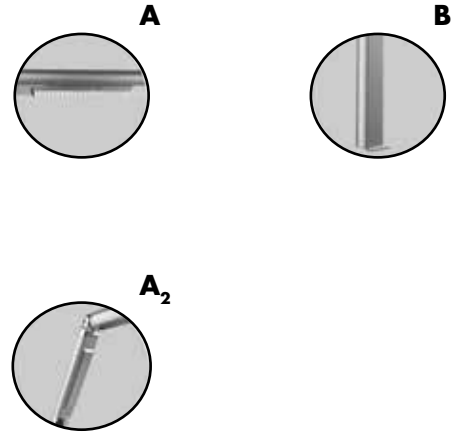

DOCCIA TRADIZIONALE CON INGRESSO ACQUA FREDDA o PREMISCELATA

- Idonea ad ambientazioni esterne, realizzate in alluminio verniciato, accessori in ottone cromato
- Completamente smontabile, riparabile e modificabile nelle misure
- Montaggio rapido ad incastri e innesti rapidi, utilizzo pratico e funzionale.
- QM970 Supporto multifunzione per sistemi di pagamento con fotocellula, per ogni tipo di utilizzo.
- QM 980 come QM 970 con regolatore termostatico.



TRADITIONAL SHOWER WITH ONLY COLD OR PRE-MIXED WATER INLET

- Suitable for both indoor and outdoor settings. Made of liquid painted aluminum and available in 4 colors, accessories in chromed brass.
- Completely removable and repairable, easily modifiable measures
- Quick assembly with interlocking and quick grafts, practical and functional use
- QM970 Multifunctional support for payment systems with photocell, for any type of use.
- QM980 as QM 970 with thermostatic regulator.



DOUCHE TRADITIONNELLE AVEC SEULE ENTRÉE D'EAU FROIDE OU PRÉ-MÉLANGÉE

- Appropriée pour les environnements intérieurs et extérieurs, réalisée en aluminium peint liquide/ disponible en 4 couleurs, accessoires en laiton chromé
- Complètement démontable et réparable. Mesures facilement modifiables
- Montage rapide avec verrouillage et raccords rapides, utilisation pratique et fonctionnelle.
- QM970 Support multifonction pour systèmes de paiement avec cellule photoélectrique, pour tout type d'utilisation
- QM980 comme QM 970 avec régulateur thermostatique



DUCHA TRADICIONAL CON SOLO TOMA DE AGUA FRÍA O PREMEZCLADA

- Es apto para su uso en interiores y exteriores, de aluminio pintado líquido / disponible en 4 colores, accesorios de latón cromado
- Completamente desmontable y reparable medidas fácilmente
- Modificables, montaje rápido con enclavamientos y enchufes rápidos, uso práctico y funcional
- QM970 Soporte multifunción para sistemas de pago con fotocélula, para cualquier tipo de uso.
- QM980 como QM 970 con regulador termostático

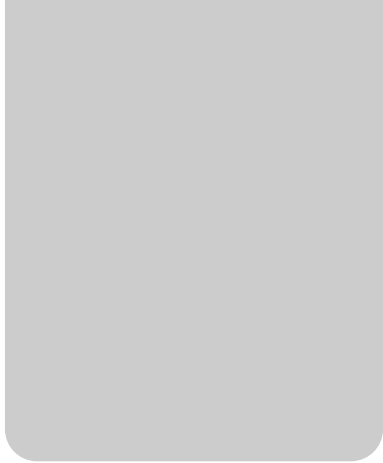

Una storia di successi dal 1988
A story of successes since 1988

AR  EMA[®]
DESIGN

MADE IN ITALY

Sostenibili per natura
Sustainable by nature



**TOP LINE
SOLARE
SOLAR**



COLORS

STANDARD COLORS TOPLINE



ORO SATINATO
Satine
1200

PERLA NERA
Slightly Metalised
7300

PERLA BIANCA
Shiny Pearl
9400

SMERALDO
Slightly Metalised
6700

SPECIAL COLORS TOPLINE



RAME
Slightly Metalised
1100

ARGENTO
Slightly Metalised
1300

ZAFFIRO
Slightly Metalised
5600

RUBINO
Slightly Metalised
3500

*EXTRA FOR SPECIAL COLORS



JOLLY PLUS B520-TL

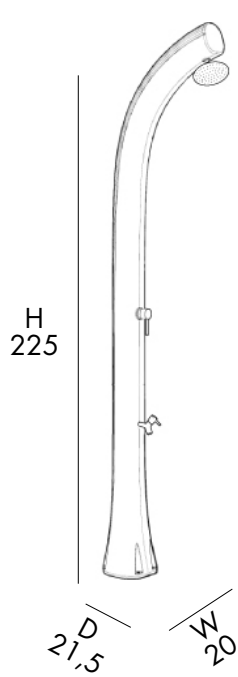

24 Lt



13 Kg



D 45 cm
H 232 cm
W 27 cm

INCLUDED



SACCO FODERA
COVER BAG

DOCCIA SOLARE

- SOFFIONE
- MISCELATORE
- LAVAPIEDI
- REALIZZATA IN POLIETILENE VERNICIATO A LIQUIDO
- ACCESSORI IN OTTONE ABS CROMATO
- ATTACCO DOCCIA LATERALE DESTRO



SOLAR SHOWER

- SHOWER HEAD
- MIXER
- FOOTWASHER TAP
- MADE IN POLYETHYLENE LIQUID PAINTING
- ACCESSORIES IN CHROMED BRASS AND CHROMED ABS
- RIGHT SIDE SHOWER ATTACHMENT

DOUCHE SOLAIRE

- POMME DE DOUCHE
- MITIGEUR
- RINCE PIEDS
- FABRIQUÉE EN POLYÉTHYLÈNE PEINT A LIQUID
- ACCESSOIRES EN LAITON CHROMÉ ET ABS
- RACCORD DE DOUCHE COTÉ DROIT



DUCHA SOLAR

- CABEZA DE DUCHA
- MEZCLADOR
- LAVAPIES
- REALIZADA EN POLIETILENO COLORADA AL LIQUIDO
- ACCESORIOS DE LATÓN CROMADO Y ABS CROMO
- ACCESORIO DE DUCHA DE LADO DERECHO



COLORS

STANDARD COLORS TOPLINE



ORO SATINATO
Satine
1200

PERLA NERA
Slightly Metalised
7300

PERLA BIANCA
Shiny Pearl
9400

SMERALDO
Slightly Metalised
6700

SPECIAL COLORS TOPLINE



RAME
Slightly Metalised
1100

ARGENTO
Slightly Metalised
1300

ZAFFIRO
Slightly Metalised
5600

RUBINO
Slightly Metalised
3500

*EXTRA FOR SPECIAL COLORS



JOLLY PLUS B540-TL

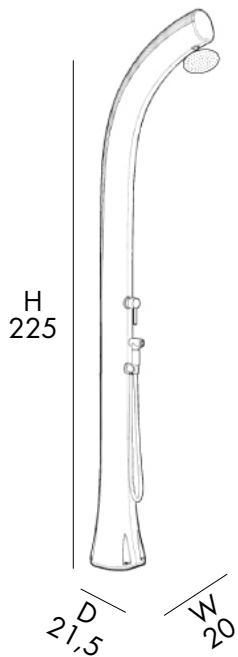

24 Lt



13,5 Kg



D 45 cm
H 232 cm
W 27 cm

INCLUDED



SACCO FODERA
COVER BAG

DOCCIA SOLARE

- SOFFIONE
- MISCELATORE
- DOCCETTA
- REALIZZATA IN POLIETILENE VERNICIATO A LIQUIDO
- ACCESSORI IN OTTONE ABS CROMATO
- ATTACCO DOCCIA LATERALE DESTRO



SOLAR SHOWER

- SHOWER HEAD
- MIXER
- HAND SHOWER
- MADE IN POLYETHYLENE LIQUID PAINTING
- ACCESSORIES IN CHROMED BRASS AND CHROMED ABS
- RIGHT SIDE SHOWER ATTACHMENT

DOUCHE SOLAIRE

- POMME DE DOUCHE
- MITIGEUR
- DOUCHETTE
- FABRIQUÉE EN POLYÉTHYLÈNE PEINT A LIQUID
- ACCESSOIRES EN LAITON CHROMÉ ET ABS
- RACCORD DE DOUCHE COTÉ DROIT



DUCHA SOLAR

- CABEZA DE DUCHA
- MEZCLADOR
- DUCHA MOVIL
- REALIZADA EN POLIETILENO COLORADA AL LIQUIDO
- ACCESORIOS DE LATÓN CROMADO Y ABS CROMO
- ACCESORIO DE DUCHA DE LADO DERECHO



COLORS

STANDARD COLORS TOPLINE



ORO SATINATO
Satine
1200

PERLA NERA
Slightly Metalised
7300

PERLA BIANCA
Shiny Pearl
9400

SMERALDO
Slightly Metalised
6700

SPECIAL COLORS TOPLINE



RAME
Slightly Metalised
1100

ARGENTO
Slightly Metalised
1300

ZAFFIRO
Slightly Metalised
5600

RUBINO
Slightly Metalised
3500

*EXTRA FOR SPECIAL COLORS



JOLLY A520-TL

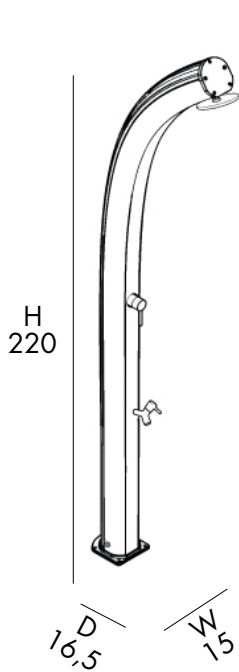

23 Lt



16 Kg



D 48 cm
H 235 cm
W 16 cm

INCLUDED



ANTI LIMESCALE
FILTER KIT



SACCO FODERA
COVER BAG

DOCCIA SOLARE

- SOFFIONE
- MISCELATORE
- LAVAPIEDI
- REALIZZATA IN ALLUMINIO VERNICIATO A POLVERE
- ACCESSORI IN OTTONE ABS CROMATO
- ATTACCO DOCCIA LATERALE DESTRO



SOLAR SHOWER

- SHOWER HEAD
- MIXER
- FOOTWASHER TAP
- MADE OF POWDER COATED ALUMINIUM
- ACCESSORIES IN CHROMED BRASS AND CHROMED ABS
- RIGHT SIDE SHOWER ATTACHMENT

DOUCHE SOLAIRE

- POMME DE DOUCHE
- MITIGEUR
- RINCE PIEDS
- FABRIQUÉE EN ALUMINIUM PEINT EN POUVRE
- ACCESSOIRES EN LAITON CHROMÉ ET ABS
- RACCORD DE DOUCHE COTÉ DROIT



DUCHA SOLAR

- CABEZA DE DUCHA
- MEZCLADOR
- LAVAPIES
- REALIZADA EN ALUMINIO PINTADO EN POLVO
- ACCESORIOS DE LATÓN CROMADO Y ABS CROMO
- ACCESORIO DE DUCHA DE LADO DERECHO



COLORS

STANDARD COLORS TOPLINE



ORO SATINATO
Satine
1200

PERLA NERA
Slightly Metalised
7300

PERLA BIANCA
Shiny Pearl
9400

SMERALDO
Slightly Metalised
6700

SPECIAL COLORS TOPLINE



RAME
Slightly Metalised
1100

ARGENTO
Slightly Metalised
1300

ZAFFIRO
Slightly Metalised
5600

RUBINO
Slightly Metalised
3500

*EXTRA FOR SPECIAL COLORS



JOLLY A540-TL

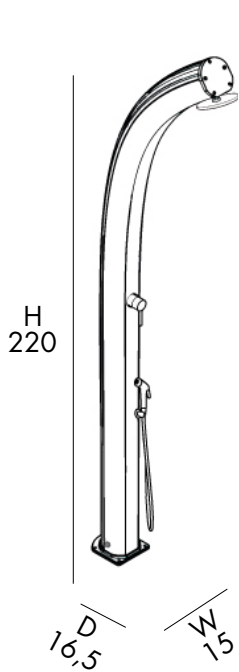

23 Lt



16,5 Kg



D 48 cm
H 235 cm
W 16 cm

INCLUDED



ANTI LIMESCALE
FILTER KIT



SACCO FODERA
COVER BAG

DOCCIA SOLARE

- SOFFIONE
- MISCELATORE
- DOCCETTA
- REALIZZATA IN ALLUMINIO VERNICIATO A POLVERE
- ACCESSORI IN OTTONE ABS CROMATO
- ATTACCO DOCCIA LATERALE DESTRO



SOLAR SHOWER

- SHOWER HEAD
- MIXER
- HAND SHOWER
- MADE OF POWDER COATED ALUMINIUM
- ACCESSORIES IN CHROMED BRASS AND CHROMED ABS
- RIGHT SIDE SHOWER ATTACHMENT

DOUCHE SOLAIRE

- POMME DE DOUCHE
- MITIGEUR
- DOUCHETTE
- FABRIQUÉE EN ALUMINIUM PEINT EN POUDRE
- ACCESSOIRES EN LAITON CHROMÉ ET ABS
- RACCORD DE DOUCHE COTÉ DROIT



DUCHA SOLAR

- CABEZA DE DUCHA
- MEZCLADOR
- DUCHA MOVIL
- REALIZADA EN ALUMINIO PINTADO EN POLVO
- ACCESORIOS DE LATÓN CROMADO Y ABS CROMO
- ACCESORIO DE DUCHA DE LADO DERECHO

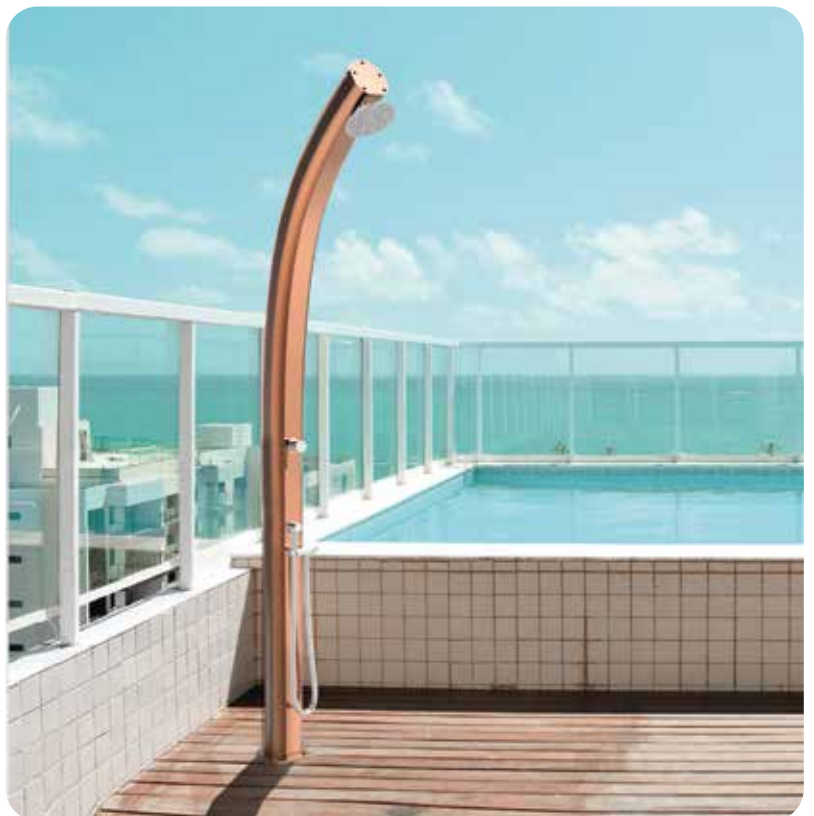

COLORS

STANDARD COLORS TOPLINE



ORO SATINATO
Satine
1200

PERLA NERA
Slightly Metalised
7300

PERLA BIANCA
Shiny Pearl
9400

SMERALDO
Slightly Metalised
6700

SPECIAL COLORS TOPLINE



RAME
Slightly Metalised
1100

ARGENTO
Slightly Metalised
1300

ZAFFIRO
Slightly Metalised
5600

RUBINO
Slightly Metalised
3500

*EXTRA FOR SPECIAL COLORS



SPRING A120-TL

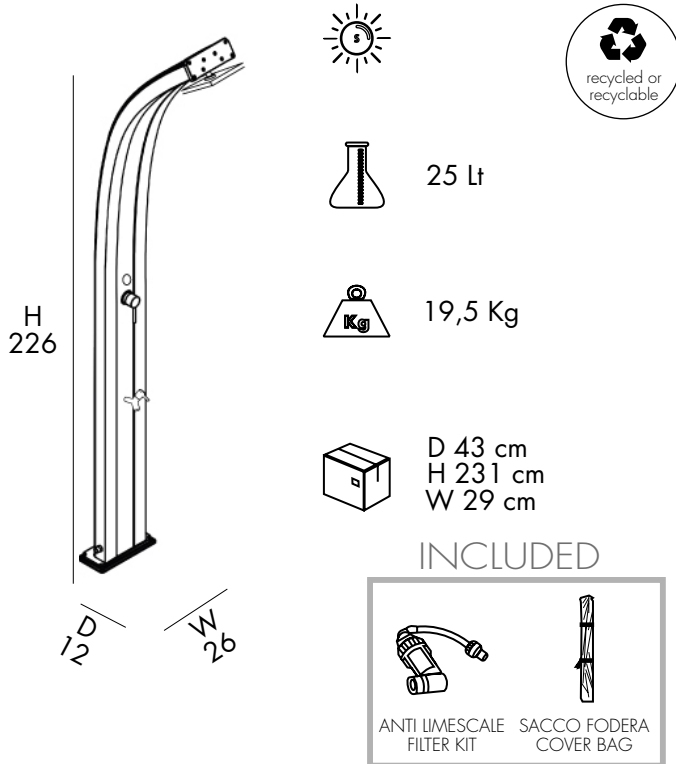

DOCCIA SOLARE

- SOFFIONE
- MISCELATORE
- LAVAPIEDI
- REALIZZATA IN ALLUMINIO VERNICIATO A POLVERE
- ACCESSORI IN OTTONE ABS CROMATO
- ATTACCO DOCCIA POSTERIORE

SOLAR SHOWER

- SHOWER HEAD
- MIXER
- FOOTWASHER TAP
- MADE OF POWDER COATED ALUMINIUM
- ACCESSORIES IN CHROMED BRASS AND CHROMED ABS
- REAR SHOWER ATTACHMENT

DOUCHE SOLAIRE

- POMME DE DOUCHE
- MITIGEUR
- RINCE PIEDS
- FABRIQUÉE EN ALUMINIUM PEINT EN POUDRE
- ACCESSOIRES EN LAITON CHROMÉ ET ABS
- RACCORD DE DOUCHE ARRIÈRE

DUCHA SOLAR

- CABEZA DE DUCHA
- MEZCLADOR
- LAVAPIES
- REALIZADA EN ALUMINIO PINTADO EN POLVO
- ACCESORIOS DE LATÓN CROMADO Y ABS CROMO
- ACCESORIO DE DUCHA TRASERA



COLORS

STANDARD COLORS TOPLINE



ORO SATINATO
Satine
1200

PERLA NERA
Slightly Metalised
7300

PERLA BIANCA
Shiny Pearl
9400

SMERALDO
Slightly Metalised
6700

SPECIAL COLORS TOPLINE



RAME
Slightly Metalised
1100

ARGENTO
Slightly Metalised
1300

ZAFFIRO
Slightly Metalised
5600

RUBINO
Slightly Metalised
3500

*EXTRA FOR SPECIAL COLORS



SPRING A140-TL

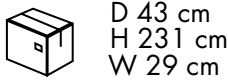
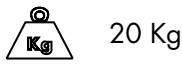
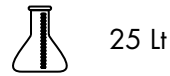
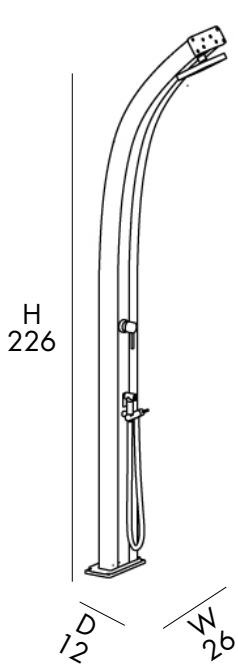

INCLUDED



DOCCIA SOLARE

- SOFFIONE
- MISCELATORE
- DOCCETTA
- REALIZZATA IN ALLUMINIO VERNICIATO A POLVERE
- ACCESSORI IN OTTONE ABS CROMATO
- ATTACCO DOCCIA POSTERIORE

SOLAR SHOWER

- SHOWER HEAD
- MIXER
- HAND SHOWER
- MADE OF POWDER COATED ALUMINIUM
- ACCESSORIES IN CROMED BRASS AND CHROMED ABS
- REAR SHOWER ATTACHMENT

DOUCHE SOLAIRE

- POMME DE DOUCHE
- MITIGEUR
- DOUCHETTE
- FABRIQUÉE EN ALUMINIUM PEINT EN POUVRE
- ACCESSOIRES EN LAITON CHROMÉ ET ABS
- RACCORD DE DOUCHE ARRIÈRE

DUCHA SOLAR

- CABEZA DE DUCHA
- MEZCLADOR
- DUCHA MOVIL
- REALIZADA EN ALUMINIO PINTADO EN POLVO
- ACCESORIOS DE LATÓN CROMADO Y ABS CROMO
- ACCESORIO DE DUCHA TRASERA

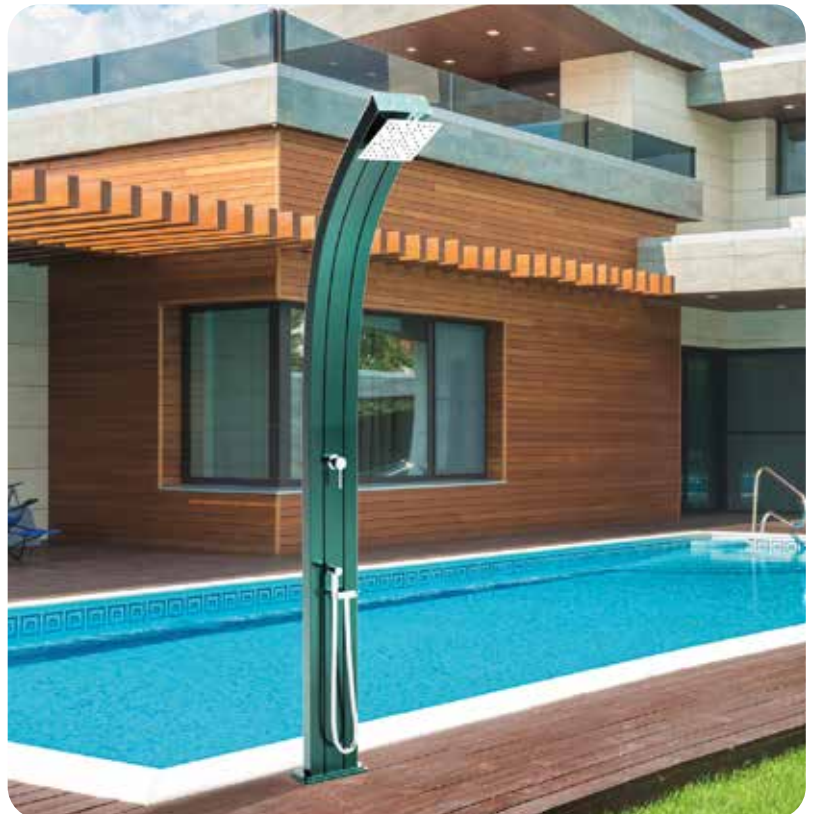

COLORS

STANDARD COLORS TOPLINE



ORO SATINATO
Satine
1200

PERLA NERA
Slightly Metalised
7300

PERLA BIANCA
Shiny Pearl
9400

SMERALDO
Slightly Metalised
6700

SPECIAL COLORS TOPLINE



RAME
Slightly Metalised
1100

ARGENTO
Slightly Metalised
1300

ZAFFIRO
Slightly Metalised
5600

RUBINO
Slightly Metalised
3500

*EXTRA FOR SPECIAL COLORS



DADA D340-TL

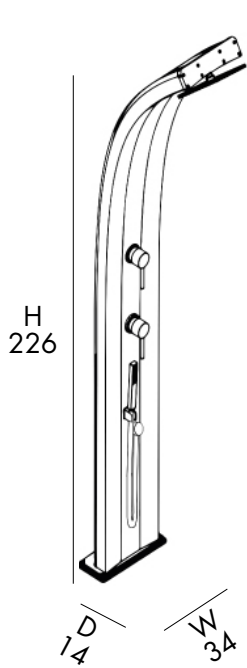

30 Lt



29,5 Kg



D 45 cm
H 231 cm
W 36 cm

INCLUDED



ANTI LIMESCALE
FILTER KIT



DEVIATORE
DIVERTER



SACCO FODERA
COVER BAG

DOCCIA SOLARE

- SOFFIONE • MISCELATORE • DOCCETTA • DEVIATORE
- KIT FILTRO ANTICALCARE
- REALIZZATA IN ALLUMINIO VERNICIATO A POLVERE
- ACCESSORI IN OTTONE ABS CROMATO
- ATTACCO DOCCIA POSTERIORE



SOLAR SHOWER

- SHOWER HEAD • MIXER • HAND SHOWER • DIVERTER
- ANTI LIMESCALE FILTER KIT
- MADE OF POWDER COATED ALUMINIUM
- ACCESSORIES IN CHROMED BRASS AND CHROMED ABS
- REAR SHOWER ATTACHMENT

DOUCHE SOLAIRE

- POMME DE DOUCHE • MITIGEUR • DOUCHETTE
- DÉVIATEUR
- KIT FILTRE ANTICALCAIRE
- FABRIQUÉE EN ALUMINIUM PEINT EN POUVRE
- ACCESSOIRES EN LAITON CHROMÉ ET ABS
- RACCORD DE DOUCHE ARRIÈRE



DUCHA SOLAR

- CABEZA DE DUCHA • MEZCLADOR • DUCHA MOVIL
- DEVIATOR
- KIT DE FILTRO ANTICAL
- REALIZADA EN ALUMINIO PINTADO EN POLVO
- ACCESORIOS DE LATÓN CROMADO Y ABS CROMO
- ACCESORIO DE DUCHA TRASERA



COLORS

STANDARD COLORS TOPLINE



ORO SATINATO
Satine
1200

PERLA NERA
Slightly Metalised
7300

PERLA BIANCA
Shiny Pearl
9400

SMERALDO
Slightly Metalised
6700

SPECIAL COLORS TOPLINE



RAME
Slightly Metalised
1100

ARGENTO
Slightly Metalised
1300

ZAFFIRO
Slightly Metalised
5600

RUBINO
Slightly Metalised
3500

*EXTRA FOR
SPECIAL COLORS



DADA D350-TL

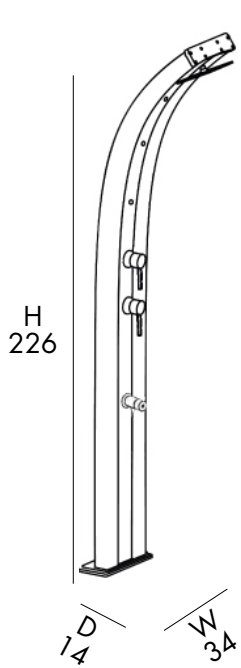

30 Lt



29,5 Kg



D 36 cm
H 231 cm
W 45 cm

INCLUDED



ANTI LIMESCALE
FILTER KIT



DEVIATORE
DIVERTER



SACCO FODERA
COVER BAG

DOCCIA SOLARE

- SOFFIONE • MISCELATORE • LAVAPIEDI TEMPORIZZATO
- DEVIATORE • 3 NEBULIZZATORI • KIT FILTRO ANTICALCARE
- REALIZZATA IN ALLUMINIO VERNICIATO A POLVERE
- ACCESSORI IN OTTONE ABS CROMATO
- ATTACCO DOCCIA POSTERIORE

SOLAR SHOWER

- SHOWER HEAD • MIXER • TEMPORIZED FOOTWASHER
- DIVERTER • 3 NEBULIZERS • ANTI LIMESCALE FILTER KIT
- MADE OF POWDER COATED ALUMINIUM
- ACCESSORIES IN CHROMED BRASS AND CHROMED ABS
- REAR SHOWER ATTACHMENT

DOUCHE SOLAIRE

- POMME DE DOUCHE • MITIGEUR • RINCE PIEDS TEMP.
- DÉVIATEUR • 3 NEBULISEURS • KIT FILTRE ANTICALCAIRE
- FABRIQUÉE EN ALUMINIUM PEINT EN POUVRE
- ACCESSOIRES EN LAITON CHROMÉ ET ABS
- RACCORD DE DOUCHE ARRIÈRE

DUCHA SOLAR

- CABEZA DE DUCHA • MEZCLADOR • LAVAPIES TEMP
- DEVIATOR • 3 NEBULIZADORES • KIT DE FILTRO ANTICAL
- REALIZADA EN ALUMINIO PINTADO EN POLVO
- ACCESORIOS DE LATÓN CROMADO Y ABS CROMO
- ACCESORIO DE DUCHA TRASERA



COLORS

STANDARD COLORS TOPLINE



ORO SATINATO
Satine
1200

PERLA NERA
Slightly Metalised
7300

PERLA BIANCA
Shiny Pearl
9400

SMERALDO
Slightly Metalised
6700

SPECIAL COLORS TOPLINE



RAME
Slightly Metalised
1100

ARGENTO
Slightly Metalised
1300

ZAFFIRO
Slightly Metalised
5600

RUBINO
Slightly Metalised
3500

*EXTRA FOR SPECIAL COLORS



DADA S D440-TL

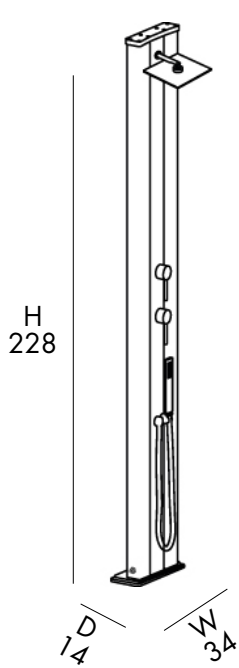

30 Lt



28,5 Kg



D 24 cm
H 231 cm
W 36 cm

INCLUDED



ANTI LIMESCALE
FILTER KIT



DEVIATORE
DIVERTER



SACCO FODERA
COVER BAG

DOCCIA SOLARE

- SOFFIONE • MISCELATORE • DOCCETTA • DEVIATORE
- KIT FILTRO ANTICALCARE
- REALIZZATA IN ALLUMINIO VERNICIATO A POLVERE
- ACCESSORI IN OTTONE ABS CROMATO
- ATTACCO DOCCIA POSTERIORE



SOLAR SHOWER

- SHOWER HEAD • MIXER • HAND SHOWER • DIVERTER
- ANTI LIMESCALE FILTER KIT
- MADE OF POWDER COATED ALUMINIUM
- ACCESSORIES IN CHROMED BRASS AND CHROMED ABS
- REAR SHOWER ATTACHMENT

DOUCHE SOLAIRE

- POMME DE DOUCHE • MITIGEUR • DOUCHETTE
- DÉVIATEUR
- KIT FILTRE ANTICALCAIRE
- FABRIQUÉE EN ALUMINIUM PEINT EN POUVRE
- ACCESSOIRES EN LAITON CHROMÉ ET ABS
- RACCORD DE DOUCHE ARRIÈRE



DUCHA SOLAR

- CABEZA DE DUCHA • MEZCLADOR • DUCHA MOVIL
- DEVIATOR
- KIT DE FILTRO ANTICAL
- REALIZADA EN ALUMINIO PINTADO EN POLVO
- ACCESORIOS DE LATÓN CROMADO Y ABS CROMO
- ACCESORIO DE DUCHA TRASERA



COLORS

STANDARD COLORS TOPLINE



SPECIAL COLORS TOPLINE



*EXTRA FOR SPECIAL COLORS



DADA S D450-TL

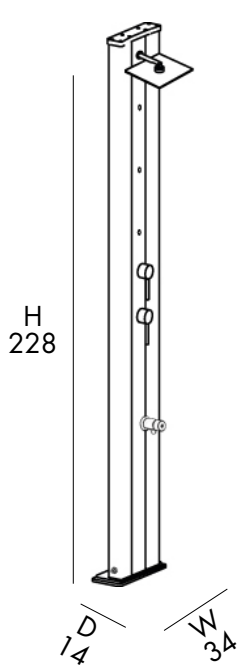

30 Lt



28,5 Kg



D 24 cm
H 231 cm
W 36 cm

INCLUDED

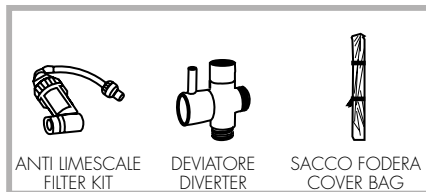

DOCCIA SOLARE

- SOFFIONE • MISCELATORE • LAVAPIEDI TEMPORIZZATO
- DEVIATORE • NEBULIZZATORI • KIT FILTRO ANTICALCARE
- REALIZZATA IN ALLUMINIO VERNICIATO A POLVERE
- ACCESSORI IN OTTONE ABS CROMATO
- ATTACCO DOCCIA POSTERIORE

SOLAR SHOWER

- SHOWER HEAD • MIXER • TEMPORIZED FOOTWASHER TAP
- DIVERTER • NEBULIZERS • ANTI LIMESCALE FILTER KIT
- MADE OF POWDER COATED ALUMINIUM
- ACCESSORIES IN CHROMED BRASS AND CHROMED ABS
- REAR SHOWER ATTACHMENT

DOUCHE SOLAIRE

- POMME DE DOUCHE • MITIGEUR • RINCE PIEDS TEMPORISÉ
- DÉVIATEUR • NÉBULISEURS • KIT FILTRE ANTICALCAIRE
- FABRIQUÉE EN ALUMINIUM PEINT EN POUVRE
- ACCESSOIRES EN LAITON CHROMÉ ET ABS
- RACCORD DE DOUCHE ARRIÈRE

DUCHA SOLAR

- CABEZA DE DUCHA • MEZCLADOR • LAVAPIES TEMPORIZADO
- DEVIATOR • NEBULIZADORES • KIT DE FILTRO ANTICAL
- REALIZADA EN ALUMINIO PINTADO EN POLVO
- ACCESORIOS DE LATÓN CROMADO Y ABS CROMO
- ACCESORIO DE DUCHA TRASERA

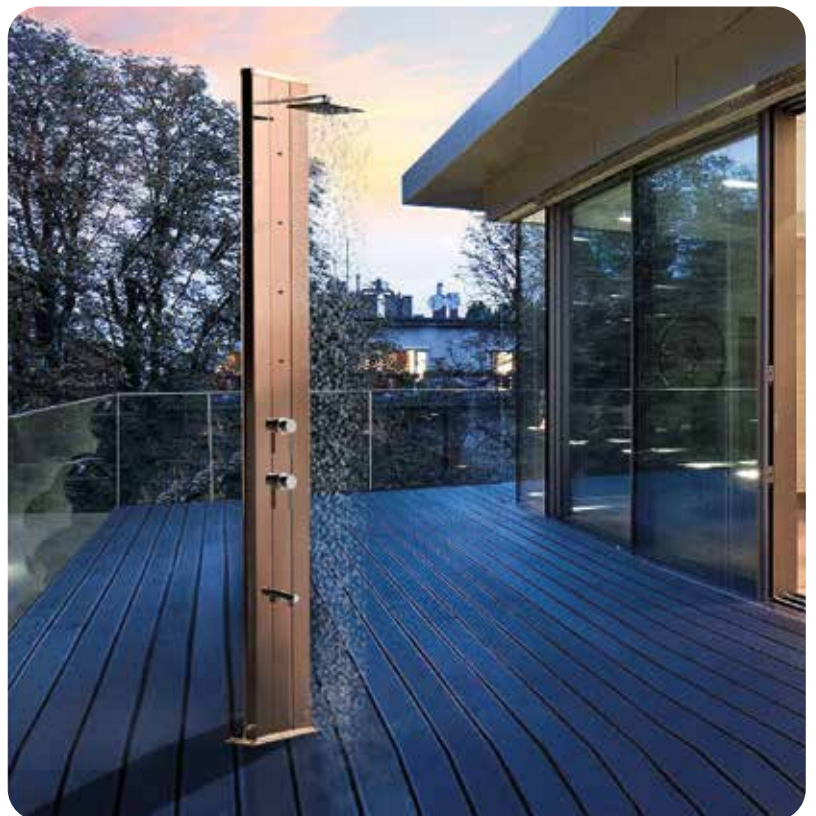



TOP LINE
TRADIZIONALE

TRADITIONAL



COLORS

STANDARD COLORS TOPLINE



SPECIAL COLORS TOPLINE



*EXTRA FOR SPECIAL COLORS



FUNNY YIN T125-TL

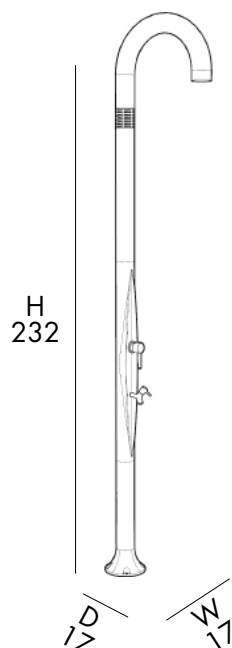

9,5 Kg



D 48 cm
H 194 cm
W 21 cm

INCLUDED



SACCO FODERA
COVER BAG

DOCCIA TRADIZIONALE

- SOFFIONE
- MISCELATORE
- LAVAPIEDI
- REALIZZATA IN POLIETILENE COLORATO A LIQUIDO
- ACCESSORI IN OTTONE ABS CROMATO
- ATTACCO DOCCIA STANDARD A PAVIMENTO, SU RICHIESTA



TRADITIONAL SHOWER

- SHOWER HEAD
- MIXER
- FOOTWASHER TAP
- MADE IN POLYETHYLENE LIQUID PAINTING
- ACCESSORIES IN CHROMED BRASS AND CHROMED ABS
- SHOWER ATTACHMENT AT THE BASE, LATERAL ON REQUEST

DOUCHE TRADITIONNELLE

- POMME DE DOUCHE
- MITIGEUR
- RINCE PIEDS
- FABRIQUÉE EN POLYÉTHYLÈNE PEINT A LIQUID
- ACCESSOIRES EN LAITON CHROMÉ ET ABS
- RACCORDEMENT DOUCHE AU SOL, LATÉRAL SUR DEMANDE



DUCHA TRADITIONAL

- CABEZA DE DUCHA
- MEZCLADOR
- LAVAPIES
- REALIZADA EN POLIETILENO COLOREADO A LIQUIDO
- ACCESORIOS DE LATÓN CROMADO Y ABS CROMO
- CONEXIÓN DE DUCHA EN EL SUELO, LATERAL BAJO PEDIDO



COLORS

STANDARD COLORS TOPLINE



SPECIAL COLORS TOPLINE



*EXTRA FOR SPECIAL COLORS



FUNNY YIN T325-TL

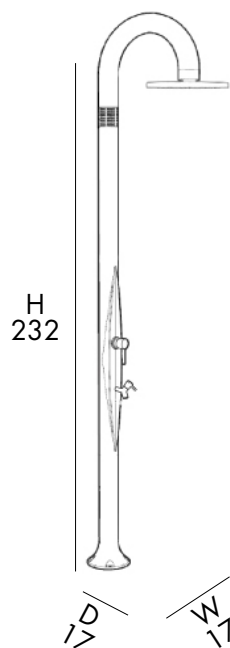

10 Kg



D 48 cm
H 194 cm
W 21 cm

INCLUDED



SACCO FODERA
COVER BAG

DOCCIA TRADIZIONALE

- SOFFIONE 250mm
- MISCELATORE
- LAVAPIEDI
- REALIZZATA IN POLIETILENE COLORATO A LIQUIDO
- ACCESSORI IN OTTONE ABS CROMATO
- ATTACCO DOCCIA STANDARD A PAVIMENTO, SU RICHIESTA



TRADITIONAL SHOWER

- SHOWER HEAD 250mm
- MIXER
- FOOTWASHER TAP
- MADE IN POLYETHYLENE LIQUID PAINTING
- ACCESSORIES IN CHROMED BRASS AND CHROMED ABS
- SHOWER ATTACHMENT AT THE BASE, LATERAL ON REQUEST

DOUCHE TRADITIONNELLE

- POMME DE DOUCHE 250mm
- MITIGEUR
- RINCE PIEDS
- FABRIQUÉE EN POLYÉTHYLÈNE PEINT A LIQUID
- ACCESSOIRES EN LAITON CHROMÉ ET ABS
- RACCORDEMENT DOUCHE AU SOL, LATÉRAL SUR DEMANDE



DUCHA TRADITIONAL

- CABEZA DE DUCHA 250mm
- MEZCLADOR
- LAVAPIES
- REALIZADA EN POLIETILENO COLOREADO A LIQUIDO
- ACCESORIOS DE LATÓN CROMADO Y ABS CROMO
- CONEXIÓN DE DUCHA EN EL SUELO, LATERAL BAJO PEDIDO



COLORS

STANDARD COLORS TOPLINE



ORO SATINATO
Satine
1200



PERLA NERA
Slightly Metalised
7300



PERLA BIANCA
Shiny Pearl
9400



SMERALDO
Slightly Metalised
6700

SPECIAL COLORS TOPLINE



RAME
Slightly Metalised
1100



ARGENTO
Slightly Metalised
1300



ZAFFIRO
Slightly Metalised
5600



RUBINO
Slightly Metalised
3500

*EXTRA FOR SPECIAL COLORS



FUNNY YIN T145-TL

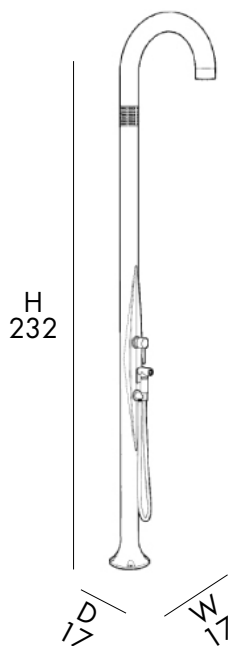

10 Kg



D 48 cm
H 194 cm
W 21 cm

INCLUDED



SACCO FODERA
COVER BAG

DOCCIA TRADIZIONALE

- SOFFIONE
- MISCELATORE
- DOCCETTA
- REALIZZATA IN POLIETILENE COLORATO A LIQUIDO
- ACCESSORI IN OTTONE ABS CROMATO
- ATTACCO DOCCIA STANDARD A PAVIMENTO, SU RICHIESTA



TRADITIONAL SHOWER

- SHOWER HEAD
- MIXER
- HAND SHOWER
- MADE IN POLYETHYLENE LIQUID PAINTING
- ACCESSORIES IN CHROMED BRASS AND CHROMED ABS
- SHOWER ATTACHMENT AT THE BASE, LATERAL ON REQUEST

DOUCHE TRADITIONNELLE

- POMME DE DOUCHE
- MITIGEUR
- DOUCHETTE
- FABRIQUÉE EN POLYÉTHYLÈNE PEINT A LIQUID
- ACCESSOIRES EN LAITON CHROMÉ ET ABS
- RACCORDEMENT DOUCHE AU SOL, LATÉRAL SUR DEMANDE



DUCHA TRADITIONAL

- CABEZA DE DUCHA
- MEZCLADOR
- DUCHA MOVIL
- REALIZADA EN POLIETILENO COLOREADO A LIQUIDO
- ACCESORIOS DE LATÓN CROMADO Y ABS CROMO
- CONEXIÓN DE DUCHA EN EL SUELO, LATERAL BAJO PEDIDO



COLORS

STANDARD COLORS TOPLINE

ORO SATINATO
Satine
1200

PERLA NERA
Slightly Metalised
7300

PERLA BIANCA
Shiny Pearl
9400

SMERALDO
Slightly Metalised
6700

SPECIAL COLORS TOPLINE

RAME
Slightly Metalised
1100

ARGENTO
Slightly Metalised
1300



ZAFFIRO
Slightly Metalised
5600

RUBINO
Slightly Metalised
3500

*EXTRA FOR SPECIAL COLORS

€

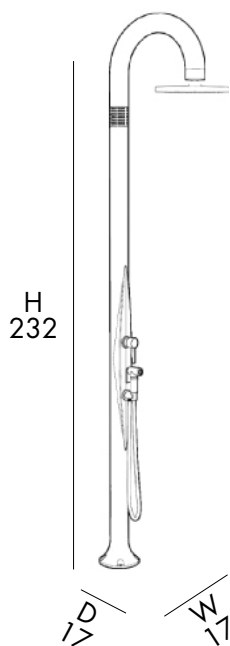
FUNNY YIN T345-TL



10,5 Kg



D 48 cm
H 194 cm
W 21 cm

INCLUDED



SACCO FODERA
COVER BAG

DOCCIA TRADIZIONALE

- SOFFIONE 250mm
- MISCELATORE
- DOCCETTA
- REALIZZATA IN POLIETILENE COLORATO A LIQUIDO
- ACCESSORI IN OTTONE ABS CROMATO
- ATTACCO DOCCIA STANDARD A PAVIMENTO, SU RICHIESTA



TRADITIONAL SHOWER

- SHOWER HEAD 250mm
- MIXER
- HAND SHOWER
- MADE IN POLYETHYLENE LIQUID PAINTING
- ACCESSORIES IN CHROMED BRASS AND CHROMED ABS
- SHOWER ATTACHMENT AT THE BASE, LATERAL ON REQUEST

DOUCHE TRADITIONNELLE

- POMME DE DOUCHE 250mm
- MITIGEUR
- DOUCHETTE
- FABRIQUÉE EN POLYÉTHYLÈNE PEINT A LIQUID
- ACCESSOIRES EN LAITON CHROMÉ ET ABS
- RACCORDEMENT DOUCHE AU SOL, LATÉRAL SUR DEMANDE



DUCHA TRADITIONAL

- CABEZA DE DUCHA 250mm
- MEZCLADOR
- DUCHA MOVIL
- REALIZADA EN POLIETILENO COLOREADO A LIQUIDO
- ACCESORIOS DE LATÓN CROMADO Y ABS CROMO
- CONEXIÓN DE DUCHA EN EL SUELO, LATERAL BAJO PEDIDO



COLORS

STANDARD COLORS TOPLINE



ORO SATINATO
Satine
1200

PERLA NERA
Slightly Metalised
7300

PERLA BIANCA
Shiny Pearl
9400

SMERALDO
Slightly Metalised
6700

SPECIAL COLORS TOPLINE



RAME
Slightly Metalised
1100

ARGENTO
Slightly Metalised
1300

ZAFFIRO
Slightly Metalised
5600

RUBINO
Slightly Metalised
3500

*EXTRA FOR SPECIAL COLORS



FUNNY YIN T355-TL

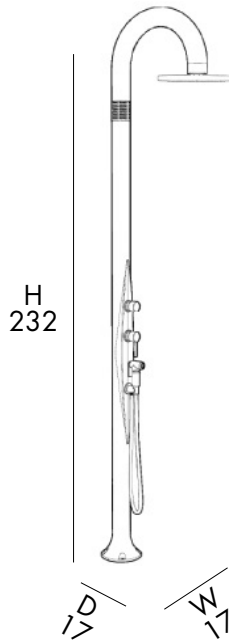

11 Kg



D 48 cm
H 194 cm
W 21 cm

INCLUDED



DEVIATORE
DIVERTER



SACCO FODERA
COVER BAG

DOCCIA TRADIZIONALE

- SOFFIONE 250mm
- MISCELATORE
- DOCCETTA • DEVIATORE
- REALIZZATA IN POLIETILENE COLORATO A LIQUIDO
- ACCESSORI IN OTTONE ABS CROMATO
- ATTACCO DOCCIA STANDARD A PAVIMENTO, SU RICHIESTA



TRADITIONAL SHOWER

- SHOWER HEAD 250mm
- MIXER
- HAND SHOWER • DIVERTER
- MADE IN POLYETHYLENE LIQUID PAINTING
- ACCESSORIES IN CHROMED BRASS AND CHROMED ABS
- SHOWER ATTACHMENT AT THE BASE, LATERAL ON REQUEST

DOUCHE TRADITIONNELLE

- POMME DE DOUCHE 250mm
- MITIGEUR
- DOUCHETTE • DÉVIEUR
- FABRIQUÉE EN POLYÉTHYLÈNE PEINT A LIQUID
- ACCESSOIRES EN LAITON CHROMÉ ET ABS
- RACCORDEMENT DOUCHE AU SOL, LATÉRAL SUR DEMANDE



DUCHA TRADITIONAL

- CABEZA DE DUCHA 250mm
- MEZCLADOR
- DUCHA MOVIL • DEVIATOR
- REALIZADA EN POLIETILENO COLOREADO A LIQUIDO
- ACCESORIOS DE LATÓN CROMADO Y ABS CROMO
- CONEXIÓN DE DUCHA EN EL SUELO, LATERAL BAJO PEDIDO



COLORS

STANDARD COLORS TOPLINE



ORO SATINATO
Satine
1200

PERLA NERA
Slightly Metalised
7300

PERLA BIANCA
Shiny Pearl
9400

SMERALDO
Slightly Metalised
6700

SPECIAL COLORS TOPLINE



RAME
Slightly Metalised
1100

ARGENTO
Slightly Metalised
1300

ZAFFIRO
Slightly Metalised
5600

RUBINO
Slightly Metalised
3500

*EXTRA FOR SPECIAL COLORS



FUNNY YIN T145-D-TL

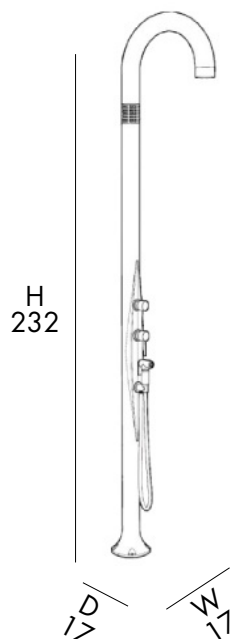

10 Kg



D 48 cm
H 194 cm
W 21 cm

INCLUDED



DEVIATORE
DIVERTER



SACCO FODERA
COVER BAG

DOCCIA TRADIZIONALE

- SOFFIONE
- MISCELATORE
- DOCCETTA
- REALIZZATA IN POLIETILENE COLORATO A LIQUIDO
- ACCESSORI IN OTTONE ABS CROMATO
- ATTACCO DOCCIA STANDARD A PAVIMENTO, SU RICHIESTA



TRADITIONAL SHOWER

- SHOWER HEAD
- MIXER
- HAND SHOWER
- MADE IN POLYETHYLENE LIQUID PAINTING
- ACCESSORIES IN CHROMED BRASS AND CHROMED ABS
- SHOWER ATTACHMENT AT THE BASE, LATERAL ON REQUEST

DOUCHE TRADITIONNELLE

- POMME DE DOUCHE
- MITIGEUR
- DOUCHETTE
- FABRIQUÉE EN POLYÉTHYLÈNE PEINT A LIQUID
- ACCESSOIRES EN LAITON CHROMÉ ET ABS
- RACCORDEMENT DOUCHE AU SOL, LATÉRAL SUR DEMANDE



DUCHA TRADITIONAL

- CABEZA DE DUCHA
- MEZCLADOR
- DUCHA MOVIL
- REALIZADA EN POLIETILENO COLOREADO A LIQUIDO
- ACCESORIOS DE LATÓN CROMADO Y ABS CROMO
- CONEXIÓN DE DUCHA EN EL SUELO, LATERAL BAJO PEDIDO



COLORS

STANDARD COLORS TOPLINE



ORO SATINATO
Satine
1200

PERLA NERA
Slightly Metalised
7300

PERLA BIANCA
Shiny Pearl
9400

SMERALDO
Slightly Metalised
6700

SPECIAL COLORS TOPLINE



RAME
Slightly Metalised
1100

ARGENTO
Slightly Metalised
1300

ZAFFIRO
Slightly Metalised
5600

RUBINO
Slightly Metalised
3500

*EXTRA FOR SPECIAL COLORS



FUNNY YANG T225-TL

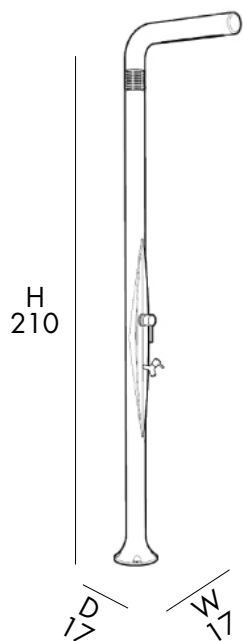

10 Kg



D 48 cm
H 194 cm
W 21 cm



INCLUDED



SACCO FODERA
COVER BAG

DOCCIA TRADIZIONALE

- SOFFIONE
- MISCELATORE
- LAVAPIEDI
- REALIZZATA IN POLIETILENE COLORATO A LIQUIDO
- ACCESSORI IN OTTONE ABS CROMATO
- ATTACCO DOCCIA STANDARD A PAVIMENTO, SU RICHIESTA



TRADITIONAL SHOWER

- SHOWER HEAD
- MIXER
- FOOTWASHER TAP
- MADE IN POLYETHYLENE LIQUID PAINTING
- ACCESSORIES IN CHROMED BRASS AND CHROMED ABS
- SHOWER ATTACHMENT AT THE BASE, LATERAL ON REQUEST

DOUCHE TRADITIONNELLE

- POMME DE DOUCHE
- MITIGEUR
- RINCE PIEDS
- FABRIQUÉE EN POLYÉTHYLÈNE PEINT A LIQUID
- ACCESSOIRES EN LAITON CHROMÉ ET ABS
- RACCORDEMENT DOUCHE AU SOL, LATÉRAL SUR DEMANDE



DUCHA TRADITIONAL

- CABEZA DE DUCHA
- MEZCLADOR
- LAVAPIES
- REALIZADA EN POLIETILENO COLOREADO A LIQUIDO
- ACCESORIOS DE LATÓN CROMADO Y ABS CROMO
- CONEXIÓN DE DUCHA EN EL SUELO, LATERAL BAJO PEDIDO



COLORS

STANDARD COLORS TOPLINE



ORO SATINATO
Satine
1200

PERLA NERA
Slightly Metalised
7300

PERLA BIANCA
Shiny Pearl
9400

SMERALDO
Slightly Metalised
6700

SPECIAL COLORS TOPLINE



RAME
Slightly Metalised
1100

ARGENTO
Slightly Metalised
1300

ZAFFIRO
Slightly Metalised
5600

RUBINO
Slightly Metalised
3500

*EXTRA FOR SPECIAL COLORS



FUNNY YANG T245-TL

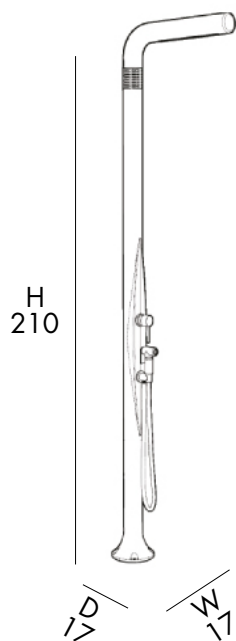

10,5 Kg



D 48 cm
H 194 cm
W 21 cm



INCLUDED



SACCO FODERA
COVER BAG

DOCCIA TRADIZIONALE

- SOFFIONE
- MISCELATORE
- DOCCETTA
- REALIZZATA IN POLIETILENE COLORATO A LIQUIDO
- ACCESSORI IN OTTONE ABS CROMATO
- ATTACCO DOCCIA STANDARD A PAVIMENTO, SU RICHIESTA



TRADITIONAL SHOWER

- SHOWER HEAD
- MIXER
- HAND SHOWER
- MADE IN POLYETHYLENE LIQUID PAINTING
- ACCESSORIES IN CHROMED BRASS AND CHROMED ABS
- SHOWER ATTACHMENT AT THE BASE, LATERAL ON REQUEST

DOUCHE TRADITIONNELLE

- POMME DE DOUCHE
- MITIGEUR
- DOUCHETTE
- FABRIQUÉE EN POLYÉTHYLÈNE PEINT A LIQUID
- ACCESSOIRES EN LAITON CHROMÉ ET ABS
- RACCORDEMENT DOUCHE AU SOL, LATÉRAL SUR DEMANDE



DUCHA TRADITIONAL

- CABEZA DE DUCHA
- MEZCLADOR
- DUCHA MOVIL
- REALIZADA EN POLIETILENO COLOREADO A LIQUIDO
- ACCESORIOS DE LATÓN CROMADO Y ABS CROMO
- CONEXIÓN DE DUCHA EN EL SUELO, LATERAL BAJO PEDIDO



COLORS

STANDARD COLORS TOPLINE



ORO SATINATO
Satine
1200

PERLA NERA
Slightly Metalised
7300

PERLA BIANCA
Shiny Pearl
9400

SMERALDO
Slightly Metalised
6700

SPECIAL COLORS TOPLINE



RAME
Slightly Metalised
1100

ARGENTO
Slightly Metalised
1300

ZAFFIRO
Slightly Metalised
5600

RUBINO
Slightly Metalised
3500

*EXTRA FOR SPECIAL COLORS



FUNNY YANG T245-D-TL

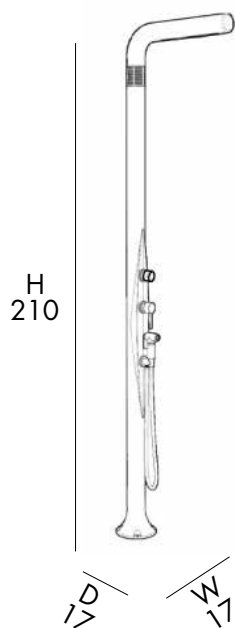

10,5 Kg



D 48 cm
H 194 cm
W 21 cm

INCLUDED



DEVIATORE
DIVERTER



SACCO FODERA
COVER BAG

DOCCIA TRADIZIONALE

- SOFFIONE
- MISCELATORE
- DOCCETTA
- REALIZZATA IN POLIETILENE COLORATO A LIQUIDO
- ACCESSORI IN OTTONE ABS CROMATO
- ATTACCO DOCCIA STANDARD A PAVIMENTO, SU RICHIESTA



TRADITIONAL SHOWER

- SHOWER HEAD
- MIXER
- HAND SHOWER
- MADE IN POLYETHYLENE LIQUID PAINTING
- ACCESSORIES IN CHROMED BRASS AND CHROMED ABS
- SHOWER ATTACHMENT AT THE FLOOR, LATERAL ON REQUEST

DOUCHE TRADITIONNELLE

- POMME DE DOUCHE
- MITIGEUR
- DOUCHETTE
- FABRIQUÉE EN POLYÉTHYLÈNE PEINT A LIQUID
- ACCESSOIRES EN LAITON CHROMÉ ET ABS
- RACCORDEMENT DOUCHE AU SOL, LATÉRAL SUR DEMANDE



DUCHA TRADITIONAL

- CABEZA DE DUCHA
- MEZCLADOR
- DUCHA MOVIL
- REALIZADA EN POLIETILENO COLOREADO A LIQUIDO
- ACCESORIOS DE LATÓN CROMADO Y ABS CROMO
- CONEXIÓN DE DUCHA EN EL SUELO, LATERAL BAJO PEDIDO



COLORS

STANDARD COLORS TOPLINE



ORO SATINATO
Satine
1200

PERLA NERA
Slightly Metalised
7300

PERLA BIANCA
Shiny Pearl
9400

SMERALDO
Slightly Metalised
6700

SPECIAL COLORS TOPLINE



RAME
Slightly Metalised
1100

ARGENTO
Slightly Metalised
1300

ZAFFIRO
Slightly Metalised
5600

RUBINO
Slightly Metalised
3500

*EXTRA FOR SPECIAL COLORS



JOLLY A525-TL

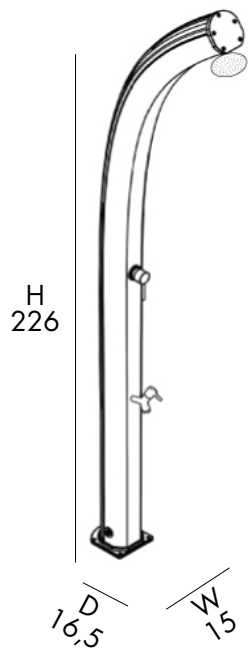

16 Kg



D 48 cm
H 232 cm
W 16 cm



recycled or recyclable

INCLUDED



SACCO FODERA
COVER BAG

DOCCIA TRADIZIONALE

- SOFFIONE
- MISCELATORE
- LAVAPIEDI
- REALIZZATA IN ALLUMINIO VERNICIATO A LIQUIDO
- ACCESSORI IN OTTONE ABS CROMATO
- ATTACCO DOCCIA LATERALE DESTRO



TRADITIONAL SHOWER

- SHOWER HEAD
- MIXER
- FOOTWASHER TAP
- MADE OF POWDER COATED ALUMINIUM
- ACCESSORIES IN CHROMED BRASS AND CHROMED ABS
- RIGHT SIDE SHOWER ATTACHMENT

DOUCHE TRADITIONNELLE

- POMME DE DOUCHE
- MITIGEUR
- RINCE PIEDS
- FABRIQUÉE EN ALUMINIUM PEINT EN POUDRE
- ACCESSOIRES EN LAITON CHROMÉ ET ABS
- RACCORDEMENT DE DOUCHE COTÉ DROIT



DUCHA TRADITIONAL

- CABEZA DE DUCHA
- MEZCLADOR
- LAVAPIES
- REALIZADA EN ALUMINIO PINTADO EN POLVO
- ACCESORIOS DE LATÓN CROMADO Y ABS CROMO
- ACCESORIO DE DUCHA DEL LADO DERECHO



COLORS

STANDARD COLORS TOPLINE

ORO SATINATO
Satine
1200

PERLA NERA
Slightly Metalised
7300

PERLA BIANCA
Shiny Pearl
9400

SMERALDO
Slightly Metalised
6700

SPECIAL COLORS TOPLINE

RAME
Slightly Metalised
1100

ARGENTO
Slightly Metalised
1300



ZAFFIRO
Slightly Metalised
5600

RUBINO
Slightly Metalised
3500

*EXTRA FOR SPECIAL COLORS

€

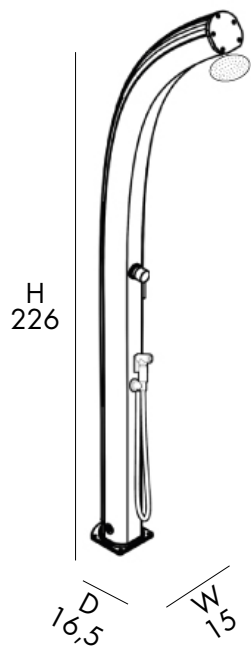
JOLLY A545-TL



16,5 Kg



D 48 cm
H 232 cm
W 16 cm

INCLUDED



SACCO FODERA
COVER BAG



DOCCIA TRADIZIONALE

- SOFFIONE
- MISCELATORE
- DOCCETTA
- REALIZZATA IN ALLUMINIO VERNICIATO A LIQUIDO
- ACCESSORI IN OTTONE ABS CROMATO
- ATTACCO DOCCIA LATERALE SINISTRO



TRADITIONAL SHOWER

- SHOWER HEAD
- MIXER
- HAND SHOWER
- MADE OF POWDER COATED ALUMINIUM
- ACCESSORIES IN CHROMED BRASS AND CHROMED ABS
- LEFT SIDE SHOWER ATTACHMENT

DOUCHE TRADITIONNELLE

- POMME DE DOUCHE
- MITIGEUR
- DOUCHETTE
- FABRIQUÉE EN ALUMINIUM PEINT EN POUVRE
- ACCESSOIRES EN LAITON CHROMÉ ET ABS
- RACCORDEMENT DE DOUCHE COTÉ GAUCHE



DUCHA TRADITIONAL

- CABEZA DE DUCHA
- MEZCLADOR
- DOUCHA MOVIL
- REALIZADA EN ALUMINIO PINTADO EN POLVO
- ACCESORIOS DE LATÓN CROMADO Y ABS CROMO
- ACCESORIO DE DUCHA DEL LADO IZQUIERDA



COLORS

STANDARD COLORS TOPLINE



ORO SATINATO
Satine
1200

PERLA NERA
Slightly Metalised
7300

PERLA BIANCA
Shiny Pearl
9400

SMERALDO
Slightly Metalised
6700

SPECIAL COLORS TOPLINE



RAME
Slightly Metalised
1100

ARGENTO
Slightly Metalised
1300

ZAFFIRO
Slightly Metalised
5600

RUBINO
Slightly Metalised
3500

*EXTRA FOR SPECIAL COLORS



SPRING A125-TL

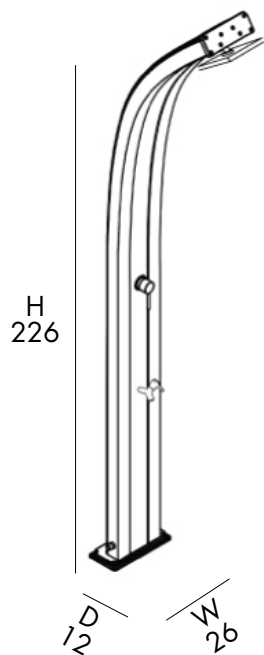

19,5 Kg



D 29 cm
H 231 cm
W 43 cm

INCLUDED



SACCO FODERA
COVER BAG

DOCCIA TRADIZIONALE

- SOFFIONE
- MISCELATORE
- LAVAPIEDI
- REALIZZATA IN ALLUMINIO VERNICIATO A LIQUIDO
- ACCESSORI IN OTTONE ABS CROMATO
- ATTACCO DOCCIA POSTERIORE



TRADITIONAL SHOWER

- SHOWER HEAD
- MIXER
- FOOTWASHER TAP
- MADE OF POWDER COATED ALUMINIUM
- ACCESSORIES IN CHROMED BRASS AND CHROMED ABS
- REAR SHOWER ATTACHMENT

DOUCHE TRADITIONNELLE

- POMME DE DOUCHE
- MITIGEUR
- RINCE PIEDS
- FABRIQUÉE EN ALUMINIUM PEINT EN POUVRE
- ACCESSOIRES EN LAITON CHROMÉ ET ABS
- RACCORDEMENT DE DOUCHE ARRIÈRE



DUCHA TRADITIONAL

- CABEZA DE DUCHA
- MEZCLADOR
- LAVAPIES
- REALIZADA EN ALUMINIO PINTADO EN POLVO
- ACCESORIOS DE LATÓN CROMADO Y ABS CROMO
- ACCESORIO DE DUCHA TRASERA

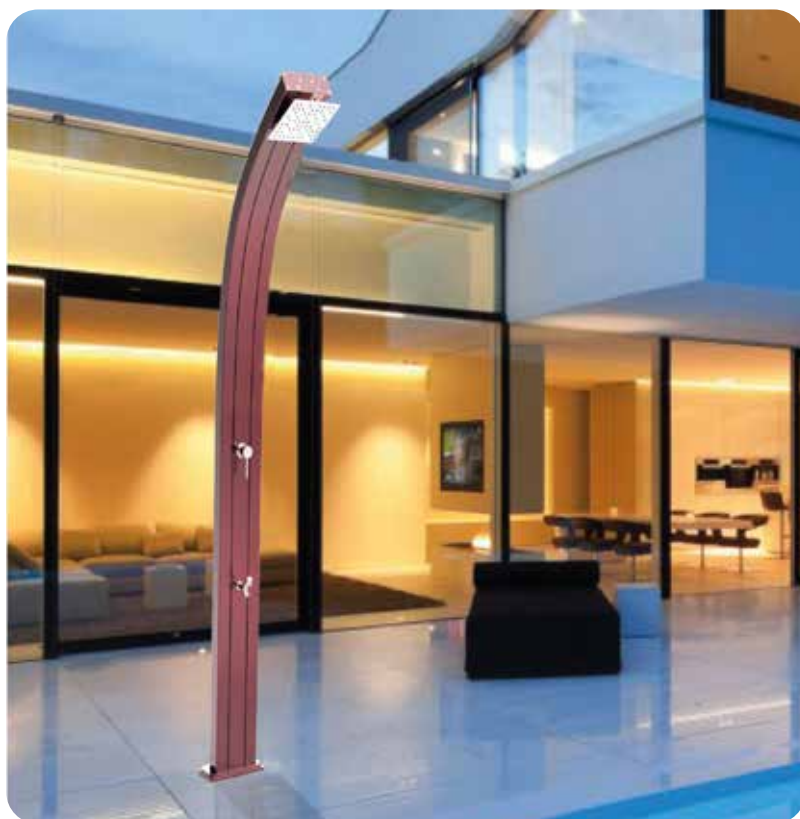

COLORS

STANDARD COLORS TOPLINE



ORO SATINATO
Satine
1200



PERLA NERA
Slightly Metalised
7300



PERLA BIANCA
Shiny Pearl
9400



SMERALDO
Slightly Metalised
6700

SPECIAL COLORS TOPLINE



RAME
Slightly Metalised
1100



ARGENTO
Slightly Metalised
1300



ZAFFIRO
Slightly Metalised
5600



RUBINO
Slightly Metalised
3500

*EXTRA FOR SPECIAL COLORS



SPRING A145-TL

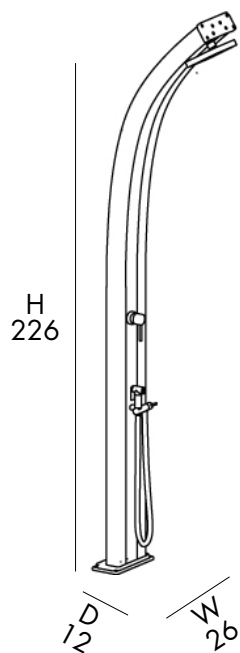

20 Kg



D 29 cm
H 231 cm
W 43 cm

INCLUDED



SACCO FODERA
COVER BAG

DOCCIA TRADIZIONALE

- SOFFIONE
- MISCELATORE
- DOCCETTA
- REALIZZATA IN ALLUMINIO VERNICIATO A LIQUIDO
- ACCESSORI IN OTTONE ABS CROMATO
- ATTACCO DOCCIA POSTERIORE



TRADITIONAL SHOWER

- SHOWER HEAD
- MIXER
- HAND SHOWER
- MADE OF POWDER COATED ALUMINIUM
- ACCESSORIES IN CHROMED BRASS AND CHROMED ABS
- REAR SHOWER ATTACHMENT

DOUCHE TRADITIONNELLE

- POMME DE DOUCHE
- MITIGEUR
- DOUCHETTE
- FABRIQUÉE EN ALUMINIUM PEINT EN POUDRE
- ACCESSOIRES EN LAITON CHROMÉ ET ABS
- RACCORDEMENT DE DOUCHE ARRIÈRE



DUCHA TRADITIONAL

- CABEZA DE DUCHA
- MEZCLADOR
- DOUCHA MOVIL
- REALIZADA EN ALUMINIO PINTADO EN POLVO
- ACCESORIOS DE LATÓN CROMADO Y ABS CROMO
- ACCESORIO DE DUCHA TRASERA



COLORS

STANDARD COLORS TOPLINE

ORO SATINATO
Satine
1200

PERLA NERA
Slightly Metalised
7300

PERLA BIANCA
Shiny Pearl
9400

SMERALDO
Slightly Metalised
6700

SPECIAL COLORS TOPLINE

RAME
Slightly Metalised
1100

ARGENTO
Slightly Metalised
1300



ZAFFIRO
Slightly Metalised
5600



RUBINO
Slightly Metalised
3500

*EXTRA FOR SPECIAL COLORS

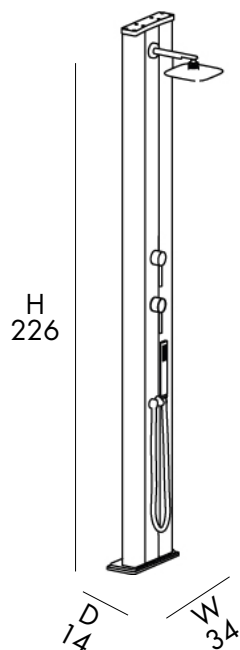
€

DADA S D445-TL



 28,5 Kg

 D 24 cm
H 231 cm
W 36 cm

INCLUDED



DEVIATORE
DIVERTER



SACCO FODERA
COVER BAG

DOCCIA TRADIZIONALE

- SOFFIONE
- MISCELATORE
- DOCCETTA • DEVIATORE
- REALIZZATA IN ALLUMINIO VERNICIATO A LIQUIDO
- ACCESSORI IN OTTONE ABS CROMATO
- ATTACCO DOCCIA POSTERIORE



TRADITIONAL SHOWER

- SHOWER HEAD
- MIXER
- HAND SHOWER • DIVERTER
- MADE OF POWDER COATED ALUMINIUM
- ACCESSORIES IN CHROMED BRASS AND CHROMED ABS
- REAR SHOWER ATTACHMENT

DOUCHE TRADITIONNELLE

- POMME DE DOUCHE
- MITIGEUR
- DOUCHETTE • DÉVIEUR
- FABRIQUÉE EN ALUMINIUM PEINT EN POUVRE
- ACCESSOIRES EN LAITON CHROMÉ ET ABS
- RACCORDEMENT DE DOUCHE COTÉ DROIT



DUCHA TRADITIONAL

- CABEZA DE DUCHA
- MEZCLADOR
- DUCHA MOVIL • DEVIATOR
- REALIZADA EN ALUMINIO PINTADO EN POLVO
- ACCESORIOS DE LATÓN CROMADO Y ABS CROMO
- ACCESORIO DE DUCHA DEL LADO DERECHO



COLORS

STANDARD COLORS TOPLINE



ORO SATINATO
Satine
1200



PERLA NERA
Slightly Metalised
7300



PERLA BIANCA
Shiny Pearl
9400



SMERALDO
Slightly Metalised
6700

SPECIAL COLORS TOPLINE



RAME
Slightly Metalised
1100



ARGENTO
Slightly Metalised
1300



ZAFFIRO
Slightly Metalised
5600



RUBINO
Slightly Metalised
3500

*EXTRA FOR SPECIAL COLORS



DADA S D455-TL

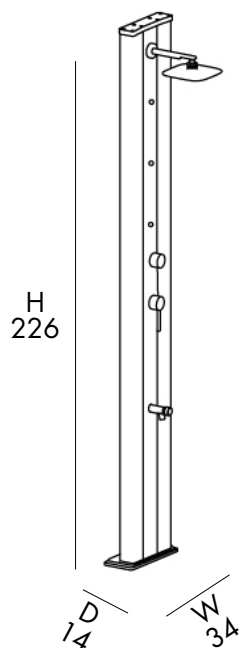

28,5 Kg



D 24 cm
H 231 cm
W 36 cm

INCLUDED



DEVIATORE
DIVERTER



SACCO FODERA
COVER BAG

DOCCIA TRADIZIONALE

- SOFFIONE
- MISCELATORE • LAVAPIEDI TEMPORIZZATO
- DOCCETTA • DEVIATORE • 3 NEBULIZZATORI
- REALIZZATA IN ALLUMINIO VERNICIATO A LIQUIDO
- ACCESSORI IN OTTONE ABS CROMATO
- ATTACCO DOCCIA POSTERIORE



TRADITIONAL SHOWER

- SHOWER HEAD
- MIXER • TEMPORIZED FOOTWASHER TAP
- HAND SHOWER • DIVERTER • 3 NEBULIZERS
- MADE OF POWDER COATED ALUMINIUM
- ACCESSORIES IN CHROMED BRASS AND CHROMED ABS
- REAR SHOWER ATTACHMENT

DOUCHE TRADITIONNELLE

- POMME DE DOUCHE
- MITIGEUR • RINCE PIEDS TEMPORISÉ
- DOUCHETTE • DÉVIATEUR • 3 NÉBULISEURS
- FABRIQUÉE EN ALUMINIUM PEINT EN POUDRE
- ACCESSOIRES EN LAITON CHROMÉ ET ABS
- RACCORDEMENT DE DOUCHE COTÉ DROIT



DUCHA TRADITIONAL

- CABEZA DE DUCHA
- MEZCLADOR • LAVAPIES TEMPORIZADO
- DUCHA MOVIL • DEVIATOR • 3 NEBULIZADORES
- REALIZADA EN ALUMINIO PINTADO EN POLVO
- ACCESORIOS DE LATÓN CROMADO Y ABS CROMO
- ACCESORIO DE DUCHA DEL LADO DERECHO



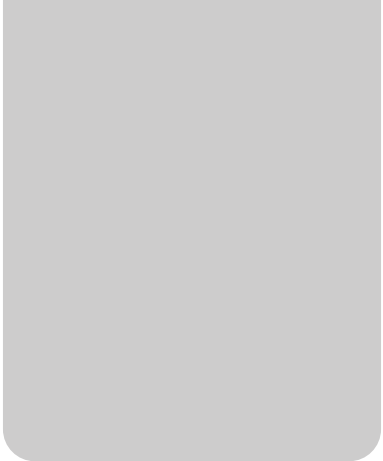

Una storia di successi dal 1988
A story of successes since 1988

ARKEMA®
DESIGN

MADE IN ITALY

Sostenibili per natura
Sustainable by nature



**PIATTI
DOCCIA
SHOWER
BASE**



PIATTO DOCCIA TOP D106

SHOWER BASE TOP D106

VASCA RACCOLTA ACQUA IN POLIETILENE RICICLATO

Tray for water collection in recycled polyethylene
 Depósito de recogida de agua en polietileno reciclado
 Réservoir de récupération d'eau en polyéthylène recyclé

PEDANA MOBILE

Openable wood platform
 Plataforma de madera practicable
 Plate-forme en bois ouvrante

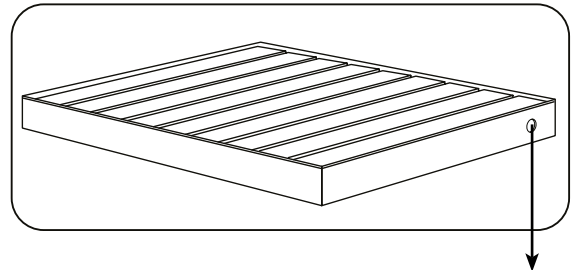
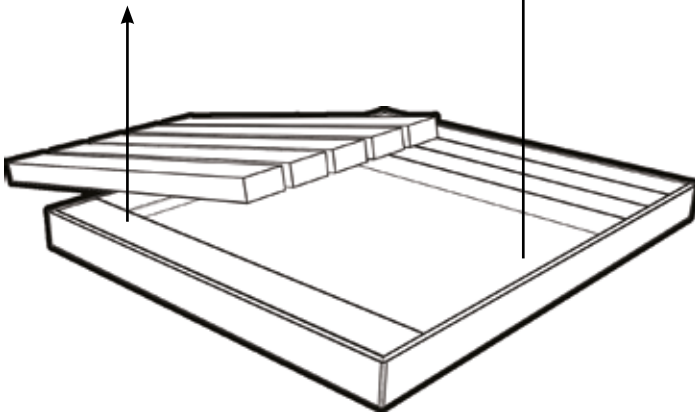

SCARICO ACQUA

Guardando il piatto doccia da dietro lo scarico è posizionato lato destro. Il diametro è di 38 mm all'esterno - 30mm interno.

Water output
 Looking at the shower tray from behind, the drain is positioned on the right side. The diameter is 38 mm outside - 30 mm inside.

Descarga de agua
 Décharge d'eau

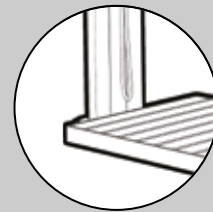
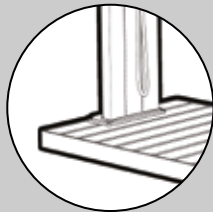

SELF SUPPORT

ON SIDE

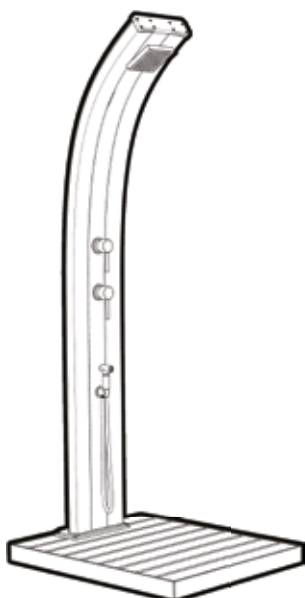

UTILIZZABILE CON LE DOCCE:
 USABLE WITH THE
 FOLLOWING SHOWERS

- HAPPY
- HAPPY ONE
- HAPPY FIVE
- HAPPY BEACH
- BIG HAPPY/BIG HAPPY FIVE
- HAPPY GO
- JOLLY
- JOLLY S
- JOLLY PLUS
- BIG JOLLY
- JOLLY GO
- JOLLY FONTANA
- JOLLY LAVAPIEDI
- SPRING
- SPRING S
- SPRING PLUS
- DADA
- DADA S
- FUNNY YIN
- FUNNY YANG
- ENERGY PRO

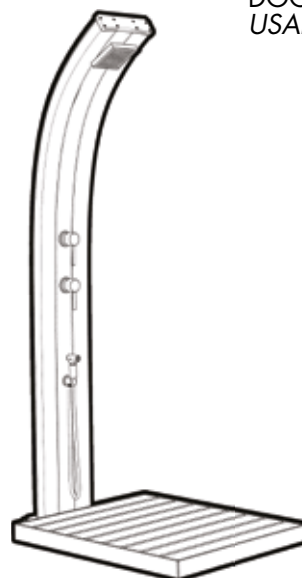

UTILIZZABILE CON TUTTE LE
 DOCCE:
 USABLE WITH ALL SHOWERS

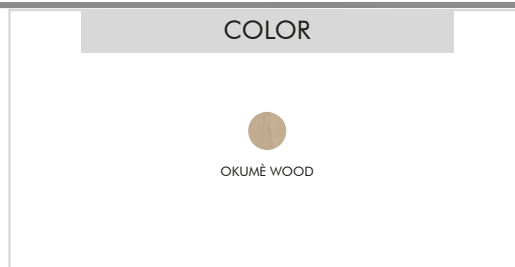

PIATTO DOCCIA TOP D106

PIATTO DOCCIA TOP

- PEDANA RIMOVIBILE PER LA PULIZIA E L'ISPEZIONE
- VASCA RACCOGLI ACQUA INTEGRATA
- SCARICO ACQUA COMPLANARE
- REALIZZATA IN IN LEGNO OKUMÉ
- IL PIATTO DOCCIA È AUTOPORTANTE SI CONSIGLIA IL FISSAGGIO A TERRA CON VITI

SHOWER BASE TOP

- OPENABLE WOOD PLATFORM FOR CLEANING AND INSPECTION
- INTEGRATED WATER COLLECTION TANK
- HORIZONTAL PARALLEL WATER DRAINING
- REALIZED IN OKUMÉ WOOD
- THE SHOWER TRAY IS SELF-SUPPORTING BUT WE RECOMMEND FIXING IT GROUND WITH SCREWS

RECEVEUR DE DOUCHA TOP

- STRUCTURE MOBILE POUR LE NETTOYAGE ET L'INSPECTION
- PLATEFORME OUVRANTE INTÉGRÉE
- ÉCHAPPEMENT D'EAU COMPLANARE
- RÉALISÉ EN BOIS OKUMÉ
- LE RECEVEUR DE DOUCHE EST AUTOPORTANT MAIS NOUS VOUS RECOMMANDONS DE LE FIXER MISE À LA TERRE AVEC VIS

BADAJA DE DUCHA TOP

- PANEL EXTRAÍBLE PARA LIMPIEZA E INSPECCIÓN
- TANQUE RECOGE DE AGUA INTEGRADA
- DESCARGA PARALELA DE AGUA
- REALIZADO EN MADERA OKUMÉ
- EL PLATO DE DUCHA ES AUTOPORTANTE PERO RECOMENDAMOS FIJARLO TIERRA CON TORNILLOS

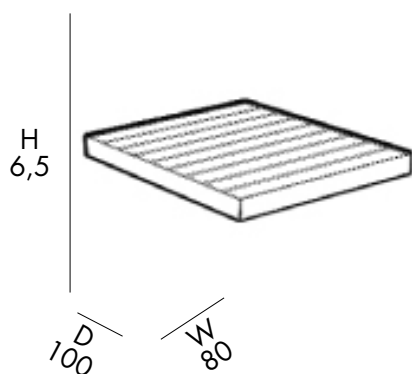

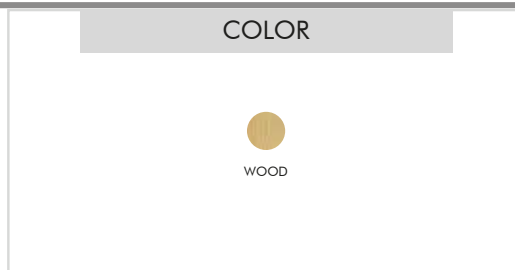

PIATTO DOCCIA ECOWOOD D107

PIATTO DOCCIA ECOWOOD

- RIALZATO DA TERRA
- PREDISPOSTO PER L'INSERIMENTO IN VASCHE DI RACCOLTA ACQUA DI SCARICO O POZZETTI
- REALIZZATA IN LEGNO DI CONIFERA

SHOWER BASE ECOWOOD

- RAISED OFF THE GROUND
- DESIGNED FOR INSTALLATION WATER COLLECTION TANKS
- REALIZED IN CONIFER WOOD

RECEVEUR DE DOUCHE ECOWOOD

- SURELEVÉ PAR TERRE
- DÉJÀ PRÊT POUR L'INSERTION DANS RESERVOIRS DE COLLECTE D'EAU
- FABRIQUÉ EN BOIS DE CONIFÈRES

BADAJA DE DUCHA ECOWOOD

- CRIADO POR LA TIERRA
- PREPARADO PARA SER INSERTADO EN DESCARGA DE TANQUES DE RECOLECCION DE AGUA
- REALIZADA EN MADERA DE CONÍFERA

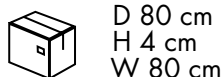
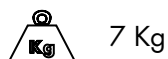
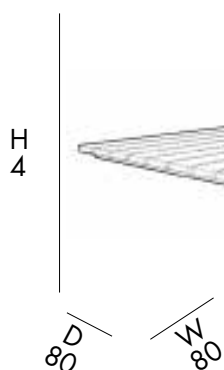

SELF SUPPORT: - HAPPY - HAPPY ONE - HAPPY FIVE - HAPPY BEACH - BIG HAPPY FIVE - HAPPY GO - JOLLY - JOLLY S - JOLLY PLUS - BIG JOLLY - JOLLY GO - JOLLY FONTANA - JOLLY LAVAPIEDI - SPRING - SPRING S - SPRING PLUS - DADA - DADA S - FUNNY YIN & FUNNY YANG (request with rear beachside/beach binoing)



COLORS

STANDARD COLORS RESIN

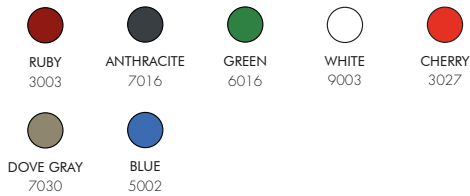

SPECIAL COLORS RESIN



*EXTRA FOR SPECIAL COLORS €

PIATTO DOCCIA LAKE D108

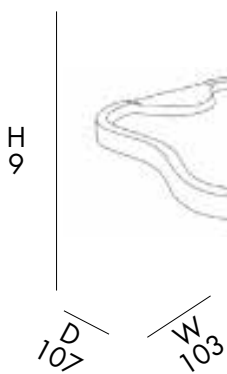

SELF SUPPORT: - HAPPY - HAPPY FIVE F520
(request with rear beachside/beach binning)



PIATTO DOCCIA LAKE

- SCARICO ACQUA COMPLANARE POSTERIORE
- REALIZZATA IN POLIETILENE COLORATO IN MASSA EFFETTO PIETRA - ANTI SDRUCCIOLO
- SCARICO ACQUA COMPLANARE
- IL PIATTO DOCCIA È AUTOPORTANTE MA CONSIGLIAMO IL FISSAGGIO A TERRA CON VITI
- SCARICO PIATTO DOCCIA DIAMETRO 1 POLLICE (32 MM)

SHOWER BASE LAKE

- REAR PARALLEL WATER DRAINING
- MADE IN POLYETHYLENE HD MASS COLOURED STONE EFFECT - ANTI SLIP
- THE SHOWER TRAY IS SELF-SUPPORTING BUT WE RECOMMEND FIXING IT WITH SCREWS TO THE GROUND
- SHOWER TRAY DRAIN DIAMETER 1 INCH (32 MM)

RECEVEUR DE DOUCHE LAKE

- ÉCHAPPEMENT D'EAU COMPLANAIRES À L'ARRIÈRE
- FABRIQUÉ EN POLYÉTHYLÈNE COLORATION MASSIVE EFFET PIERRE - ANTI GLISSEMENT
- LE RECEVEUR DE DOUCHE EST AUTOPORTANT MAIS NOUS VOUS RECOMMANDONS DE LE FIXER AU SOL AVEC VIS
- DIAMÈTRE DU DRAIN 1 POUCE (32 MM)

BANDAJE DE DUCHA LAKE

- DESCARGA PARALELA DE AGUA TRASERA
- REALIZADA EN POLIETILENO COLOREADO A GRANEL EFECTO PIEDRA - ANTI DESLIZANTE
- EL PLATO DE DUCHA ES AUTOPORTANTE PERO RECOMENDAMOS FIJARLO TIERRA CON TORNILLOS
- DIÁMETRO DEL DESAGÜE DEL PLATO DE DUCHA 1 PULGADA (32 MM)



STANDARD COLORS RESIN



WHITE
9003

PIATTO DOCCIA OTTAGONALE QP110 SMART

PIATTO DOCCIA OTTAGONALE

- REALIZZATO IN PE HD
- SCARICO COMPLEMENTARE 1"

🇬🇧 OCTAGONAL SHOWER BASE TOP

- MADE IN HD PE
- COMPLEMENTARY DRAIN 1"

RECEVEUR DE DOUCHE OCTOGONAL

- FABRIQUÉ EN PEAD
- DRAIN COMPLÉMENTAIRE 1"

🇪🇸 BADAJA DE DUCHA OCTOGONAL

- HECHO EN PEAD
- DRENAJE COMPLEMENTARIO 1"

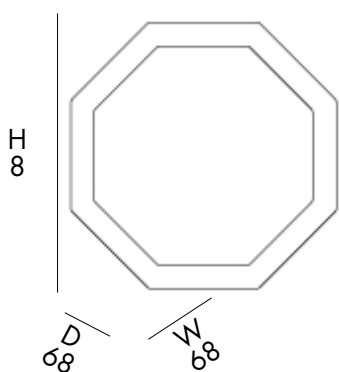

4 Kg



D 80 cm
H 10 cm
W 80 cm



SELF SUPPORT: - QUICK

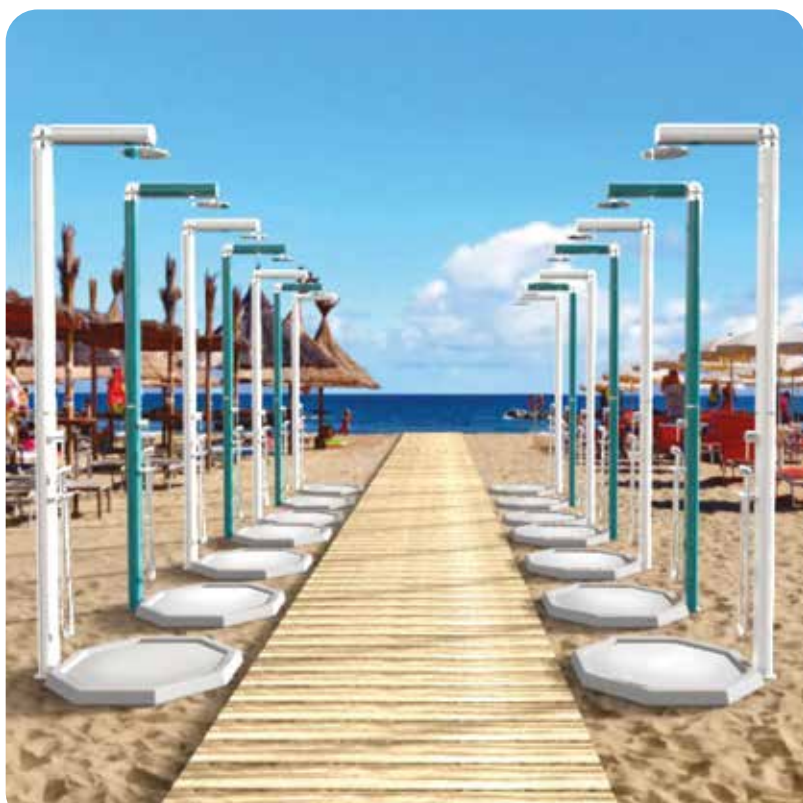

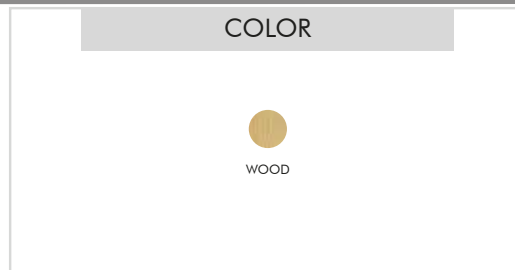

PIATTO DOCCIA OTTAGONALE QP110 WOOD

PIATTO DOCCIA OTTAGONALE

- REALIZZATO IN PE HD - LISTELLI IN LEGNO DI CONIFERA
- SCARICO COMPLEMENTARE 1"
- LA PEDANA IN LEGNO È RIMOVIBILE

🇬🇧 OCTOGONAL SHOWER BASE

- MADE IN HD PE - CONIFEROUS WOOD SLATS
- COMPLEMENTARY DRAIN 1"
- THE WOODEN PLATFORM IS REMOVABLE

RECEVEUR DE DOUCHE OCTAGONAL

- FABRIQUÉ EN PEAD - LAMES DE BOIS DE CONIFÈRES
- DRAIN COMPLÉMENTAIRE 1"
- LA PLATE-FORME EN BOIS EST AMOVIBLE

🇪🇸 BADAJA DE DUCHA OCTAGONAL

- HECHO EN PEAD - LAMAS DE MADERA DE CONIFERA
- DRENAJE COMPLEMENTARIO 1"
- LA PLATAFORMA DE MADERA ES DESMONTABLE

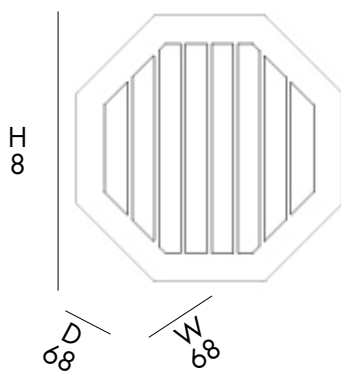

6 Kg



D 80 cm
H 10 cm
W 80 cm

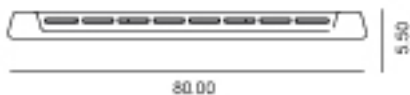

recycled or
recyclable





FOUNTAIN
SOLAR &
TRADITIONAL



L'ADATTIVITÀ DELLE FONTANE

THE ADAPTIVITY OF FOUNTAINS



FONTANE TRADIZIONALI E SOLARI

Idonea ad ambientazioni esterne, realizzate in resina colorata in massa o in alluminio verniciato a polvere disponibile in diversi colori, gli accessori sono in ottone cromato. Di facile installazione, non occorrono specifiche competenze. queste fontane sono particolarmente idonee per location come:



piccoli giardini



terrazze



camper



villaggi



campeggi



TRADITIONAL AND SOLAR FOUNTAINS

Suitable for outdoor settings, made of mass-coloured resin or powder-coated aluminium, and available in different colours. Accessories are in chrome-plated brass. Easy to install, no special skills required. These fountains are particularly suitable for locations such as:



small gardens



terraces



camper vans



villages



campsites



FONTAINES TRADITIONNELLES ET SOLAIRES

Adaptées à l'extérieur, en résine teintée dans la masse ou en aluminium peint par poudrage, disponibles en différentes couleurs, les accessoires sont en laiton chromé. Faciles à installer, elles ne nécessitent aucune compétence particulière. Ces fontaines sont particulièrement adaptées aux lieux tels que:



les petits jardins



les terrasses



camping-cars



les villages



les campings



FUENTES TRADICIONALES Y SOLARES

Adecuadas para exteriores, fabricadas en resina coloreada en masa o aluminio con revestimiento de polvo disponible en diferentes colores, los accesorios son de latón cromado. Fáciles de instalar, no requieren ninguna habilidad especial. Estas fuentes son especialmente adecuadas para lugares como:



pequeños jardines



terrazas



autocaravanas



plueblos



campingss

COLORS

STANDARD COLORS RESIN

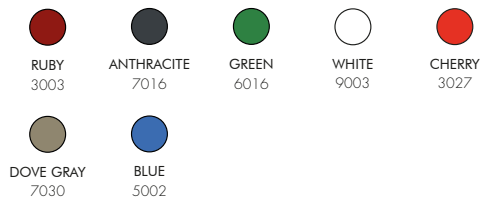

SPECIAL COLORS RESIN



*EXTRA FOR
SPECIAL COLORS

€

HAPPY GO HG140

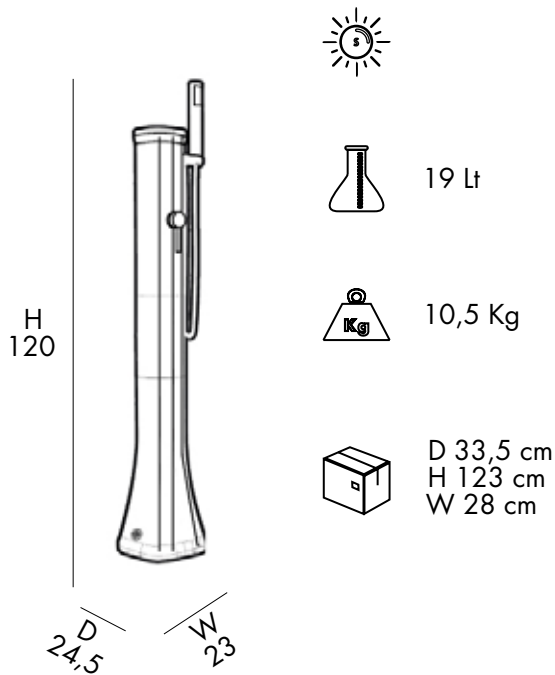

FONTANA SOLARE

- MISCELATORE
- DOCCETTA
- REALIZZATA IN POLIETILENE COLORATO IN MASSA
- ACCESSORI IN OTTONE ABS CROMATO
- ATTACCO DELLA FONTANA POSTERIORE

SOLAR FOUNTAIN

- MIXER
- HAND SHOWER
- MADE IN HD MASS COLORED POLYETHYLENE
- ACCESSORIES IN CHROMED BRASS AND CHROMED ABS
- REAR FOUNTAIN ATTACHMENT

FONTAINE SOLAIRE

- MITIGEUR
- DOUCHETTE
- FABRIQUÉE EN POLYÉTHYLÈNE COLORÉ DANS LA MASSE
- ACCESSOIRES EN LAITON CHROMÉ ET ABS
- RACCORDEMENT DE FONTAINE COTÉ DROIT

FUENTE SOLAR

- MEZCLADOR
- DUCHA MOVIL
- REALIZADA EN POLIETILENO COLOREADO A GRANEL EN MASE
- ACCESORIOS DE LATÓN CROMADO Y ABS CROMO
- ACCESPRIO DE FUENTE DEL LADO DERECHO

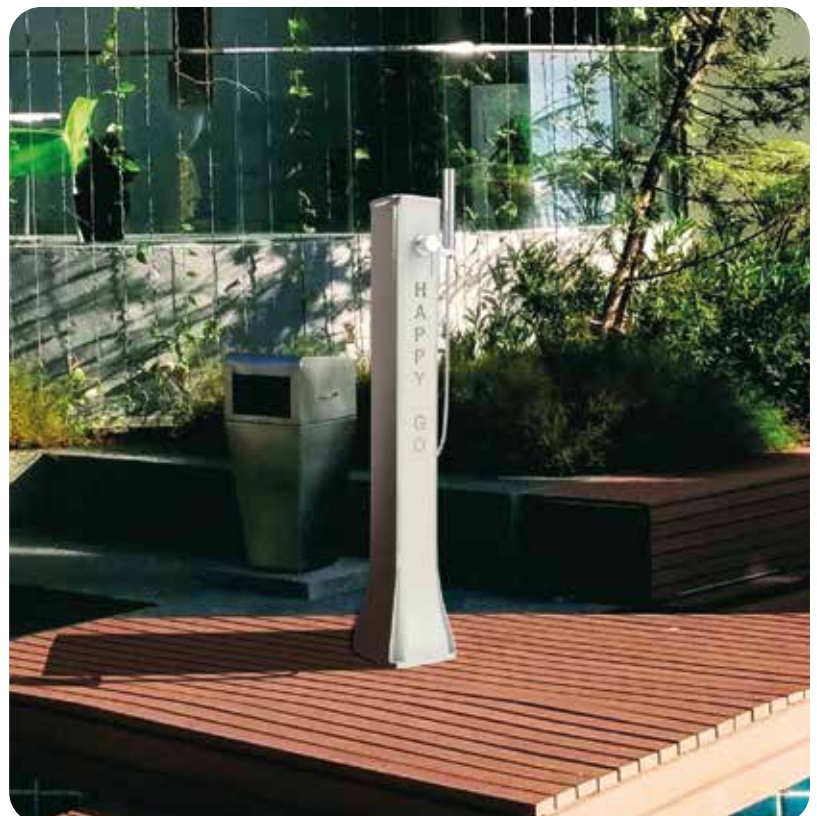

COLORS

STANDARD COLORS RESIN

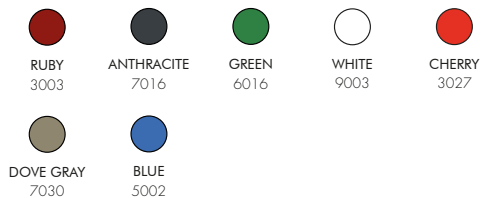

SPECIAL COLORS RESIN



*EXTRA FOR
SPECIAL COLORS



HAPPY GO HG180

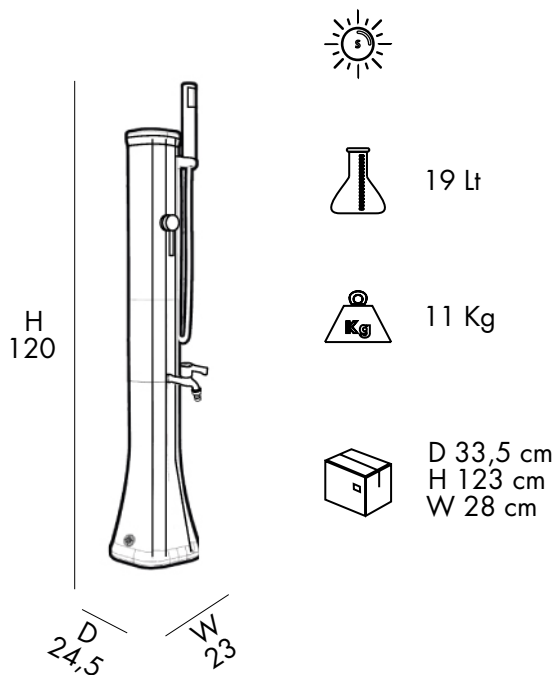

FONTANA SOLARE

- MISCELATORE
- DOCCETTA
- RUBINETTO PORTAGOMME
- REALIZZATA IN POLIETILENE COLORATO IN MASSA
- ACCESSORI IN OTTONE ABS CROMATO
- ATTACCO DELLA FONTANA POSTERIORE

SOLAR FOUNTAIN

- MIXER
- HAND SHOWER
- GARDEN TAP
- MADE IN HD MASS COLORED POLYETHYLENE
- ACCESSORIES IN CHROMED BRASS AND CHROMED ABS
- REAR FOUNTAIN ATTACHMENT

FONTAINE SOLAIRE

- MITIGEUR
- DOUCHETTE
- ROBINET TUYAU
- FABRIQUÉE EN POLYÉTHYLÈNE COLORÉ DANS LA MASSE
- ACCESSOIRES EN LAITON CHROMÉ ET ABS
- RACCORDEMENT DE FONTAINE COTÉ DROIT

FUENTE SOLAR

- MEZCLADOR
- DUCHA MOVIL
- GRIFO DE MANGUERA
- REALIZADA EN POLIETILENO COLOREADO A GRANEL EN MASE
- ACCESORIOS DE LATÓN CROMADO Y ABS CROMO
- ACCESPRIO DE FUENTE DEL LADO DERECHO



COLORS

STANDARD COLORS ALUMINIUM

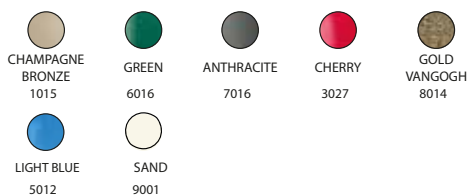

SPECIAL COLORS ALUMINIUM



*EXTRA FOR SPECIAL COLORS



JOLLY GO JG140

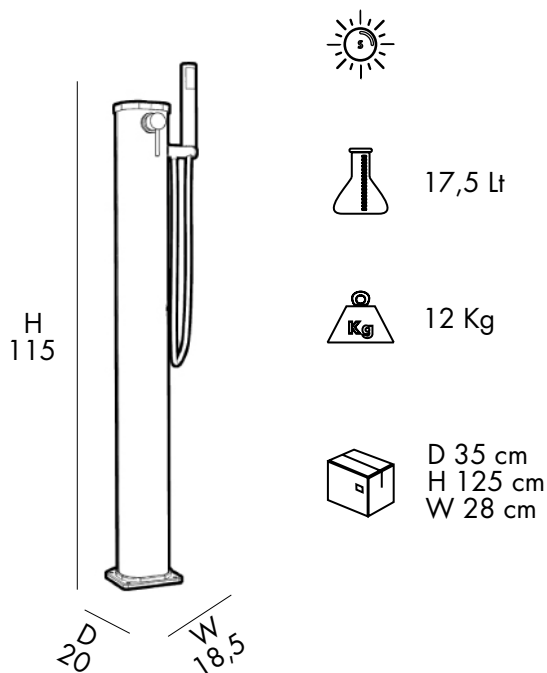

FONTANA SOLARE

- MISCELATORE
- DOCCETTA
- REALIZZATA IN ALLUMINIO VERNICIATO A POLVERE
- ACCESSORI IN OTTONE ABS CROMATO
- ATTACCO DELLA FONTANA LATERALE DESTRO

UK SOLAR FOUNTAIN

- MIXER
- HAND SHOWER
- MADE OF POWDER COATED ALUMINIUM
- ACCESSORIES IN CHROMED BRASS AND CHROMED ABS
- RIGHT SIDE FOUNTAIN ATTACHMENT

FR FONTAINE SOLAIRE

- MITIGEUR
- DOUCHETTE
- FABRIQUÉE EN ALUMINIUM PEINT EN POUVRE
- ACCESSOIRES EN LAITON CHROMÉ ET ABS
- RACCORDEMENT DE FONTAINE COTÉ DROIT

ES FUENTE SOLAR

- MEZCLADOR
- DUCHA MOVIL
- REALIZADA EN ALUMINIO PINTADO EN POLVO
- ACCESORIOS DE LATÓN CROMADO Y ABS CROMO
- ACCESORIO DE FUENTE DEL LATO DERECHO



COLORS

STANDARD COLORS ALUMINIUM

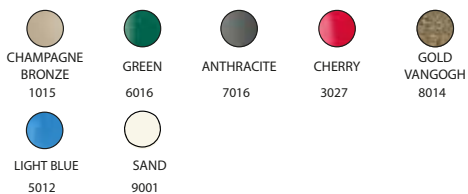

SPECIAL COLORS ALUMINIUM



*EXTRA FOR
SPECIAL COLORS

€

JOLLY GO JG150

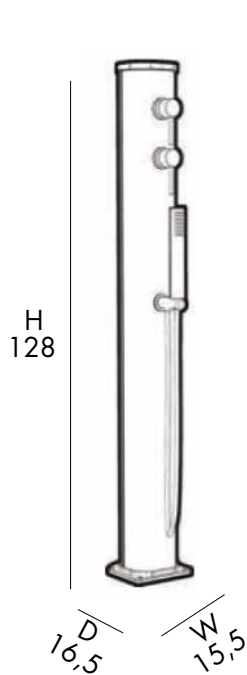

13 Lt



10,5 Kg



D 30 cm
H 130 cm
W 17 cm

INCLUDED



DEVIATORE
DIVERTER

FONTANA SOLARE

- MISCELATORE • DOCCETTA • DEVIATORE
- RUBINETTO • NEBULIZZATORE
- REALIZZATA IN ALLUMINIO VERNICIATO A POLVERE
- ACCESSORI IN OTTONE ABS CROMATO
- ATTACCO DELLA FONTANA LATERALE DESTRO



SOLAR FOUNTAIN

- MIXER • HAND SHOWER • DIVERTER
- TAP • NEBULIZER
- MADE OF POWDER COATED ALUMINIUM
- ACCESSORIES IN CHROMED BRASS AND CHROMED ABS
- RIGHT SIDE FOUNTAIN ATTACHMENT

FONTAINE SOLAIRE

- MITIGEUR • DOUCHETTE • DÉVIEUR
- ROBINET • NEBULISEUR
- FABRIQUÉE EN ALUMINIUM PEINT EN POUFRE
- ACCESSOIRES EN LAITON CHROMÉ ET ABS
- RACCORDEMENT DE FONTAINE COTÉ DROIT

FUENTE SOLAR

- MEZCLADOR • DUCHA MOVIL • DEVIATEUR
- GRIFO • NEBULIZADOR
- REALIZADA EN ALUMINIO PINTADO EN POLVO
- ACCESORIOS DE LATÓN CROMADO Y ABS CROMO
- ACCESORIO DE FUENTE DEL LATO DERECHO



COLORS

STANDARD COLORS ALUMINIUM

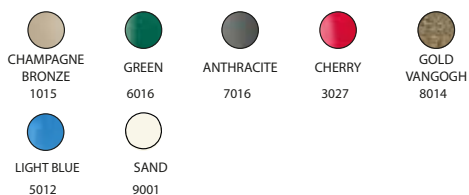

SPECIAL COLORS ALUMINIUM



*EXTRA FOR
SPECIAL COLORS



JOLLY GO JG180

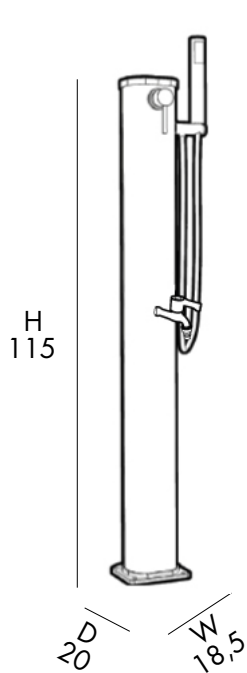

17,5 Lt



12,5 Kg



D 35 cm
H 125 cm
W 28 cm

FONTANA SOLARE

- MISCELATORE
- DOCCETTA MOBILE • RUBINETTO PORTA GOMMA
- REALIZZATA IN ALLUMINIO VERNICIATO A POLVERE
- ACCESSORI IN OTTONE ABS CROMATO
- ATTACCO DELLA FONTANA LATERALE DESTRO

UK SOLAR FOUNTAIN

- MIXER
- HAND SHOWER • GARDEN TAP
- MADE OF POWDER COATED ALUMINIUM
- ACCESSORIES IN CHROMED BRASS AND CHROMED ABS
- RIGHT SIDE FOUNTAIN ATTACHMENT

FONTAINE SOLAIRE

- MITIGEUR
- DOUCHETTE • ROBINET TUYAU
- FABRIQUÉE EN ALUMINIUM PEINT EN POUDRE
- ACCESSOIRES EN LAITON CHROMÉ ET ABS
- RACCORDEMENT DE FONTAINE COTÉ DROIT

ES FUENTE SOLAR

- MEZCLADOR
- DUCHA MOVIL • GRIFO DE MANGUERA
- REALIZADA EN ALUMINIO PINTADO EN POLVO
- ACCESORIOS DE LATÓN CROMADO Y ABS CROMO
- ACCESORIO DE FUENTE DEL LATO DERECHO



COLORS

STANDARD COLORS RESIN

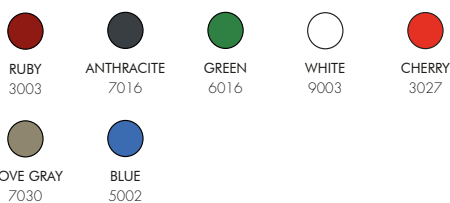

SPECIAL COLORS RESIN



*EXTRA FOR SPECIAL COLORS



H2O GH115

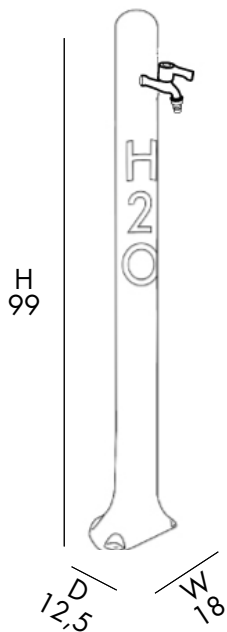

Only cold water



2,5 Kg



D 19 cm
H 101 cm
W 15 cm



FONTANA TRADITIONALE

- RUBINETTO PORTA GOMMA
- REALIZZATA IN POLIETILENE COLORATO IN MASSA
- ACCESSORI IN OTTONE ABS CROMATO
- ATTACCO A PAVIMENTO O LATERALE



TRADITIONAL FOUNTAIN

- GARDEN TAP
- MADE IN HD MASS COLORED POLYETHYLENE
- ACCESSORIES IN CHROMED BRASS AND CHROMED ABS
- FLOOR OR SIDE ATTACHMENT

FONTAINE TRADITIONNELLE

- ROBINET TUYAU
- FABRIQUÉE EN POLYÉTHYLÈNE COLORÉ DANS LA MASSE
- ACCESSOIRES EN LAITON CHROMÉ ET ABS
- MONTAGE AU SOL OU SUR LE COTÉ



FUENTE TRADITIONAL

- GRIFO DE MANGUERA
- REALIZADA EN POLIETILENO COLOREADO A GRANDEL EN MASE
- ACCESORIOS DE LATÓN CROMADO Y ABS CROMO
- MONTAJE DE PISO O LATERAL



COLORS

STANDARD COLORS RESIN

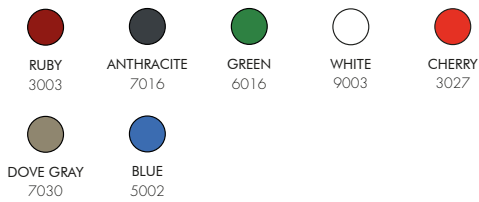

SPECIAL COLORS RESIN



*EXTRA FOR SPECIAL COLORS



H2O GH115/20

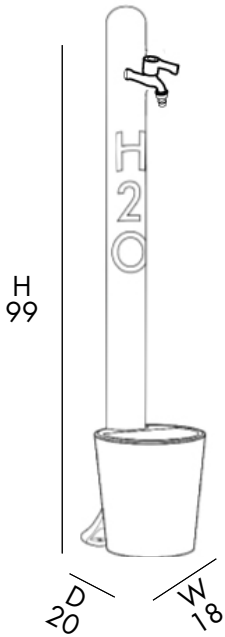

Only cold water



4 Kg



D 15 cm
H 101 cm
W 19 cm



D 22 cm
H 22 cm
W 21,5 cm

FONTANA TRADIZIONALE

- RUBINETTO PORTA GOMMA
- CESTELLO
- REALIZZATA IN POLIETILENE COLORATO IN MASSA
- ACCESSORI IN OTTONE ABS CROMATO
- ATTACCO A PAVIMENTO O LATERALE
- IL CESTELLO HA UN SUO IMBALLO



TRADITIONAL FOUNTAIN

- GARDEN TAP
- BASKET
- MADE IN HD MASS COLORED POLYETHYLENE
- ACCESSORIES IN CHROMED BRASS AND CHROMED ABS
- FLOOR OR SIDE ATTACHMENT
- THE BASKET HAS ITS OWN PACKAGING

FONTAINE TRADITIONNELLE

- ROBINET TUYAU
- SEAU
- FABRIQUÉE EN POLYÉTHYLÈNE COLORÉ DANS LA MASSE
- ACCESSOIRES EN LAITON CHROMÉ ET ABS
- MONTAGE AU SOL OU SUR LE COTÉ
- LE PANIER A SON PROPRE EMBALLAGE



FUENTE TRADICIONAL

- GRIFO DE MANGUERA
- CESTA
- REALIZADA EN POLIETILENO COLOREADO A GRANEL EN MASE
- ACCESORIOS DE LATÓN CROMADO Y ABS CROMO
- MONTAJE DE PISO O LATERAL
- LA CESTA TIENE SU PROPIO EMBALAJE



COLORS

STANDARD COLORS ALUMINIUM

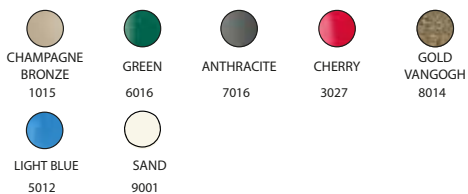

SPECIAL COLORS ALUMINIUM



*EXTRA FOR
SPECIAL COLORS



GARDEN SURPRISE GS145

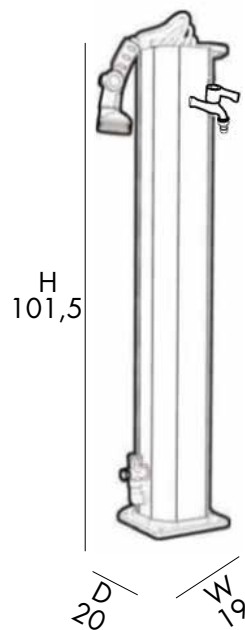

 10 Kg

 D 22 cm
H 100 cm
W 21 cm

FONTANA TRADIZIONALE

- RUBINETTO PORTA GOMMA • PISTOLA DA IRRIGAZIONE
- TUBO SPIRALATO 15M
- REALIZZATA IN ALLUMINIO VERNICIATO A POLVERE
- ACCESSORI IN OTTONE ABS CROMATO
- ATTACCO FONTANA LATERALE

TRADITIONAL FOUNTAIN

- GARDEN TAP • HOSE WATERING GUN
- GARDEN SPIRAL TUBE 15M
- MADE OF POWDER COATED ALUMINIUM
- ACCESSORIES IN CHROMED BRASS AND CHROMED ABS
- SIDE FOUNTAIN CONNECTION

FONTAINE TRADITIONNELLE

- ROBINET TUYAU • PISTOLET D'IRRIGATION
- TUBE SPIRALE JARDIN 15M
- FABRIQUÉE EN ALUMINIUM PEINT EN POUVRE
- ACCESSOIRES EN LAITON CHROMÉ ET ABS
- RACCORDEMENT DE LA FONTAINE LATÉRALE

FUENTE TRADITIONAL

- GRIFO DE MANGUERA • PISTOLA DE RIEGO
- MANGUERA ESPIRAL 15M
- REALIZADA EN ALUMINIO PINTADO EN POLVO
- ACCESORIOS DE LATÓN CROMADO Y ABS CROMO
- CONEXIÓN FUENTE LATERAL



COLORS

STANDARD COLORS ALUMINIUM

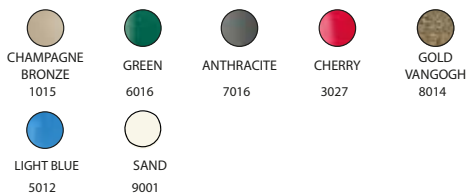

SPECIAL COLORS ALUMINIUM



*EXTRA FOR
SPECIAL COLORS

€

JOLLY GO JG145

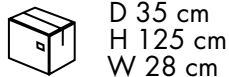
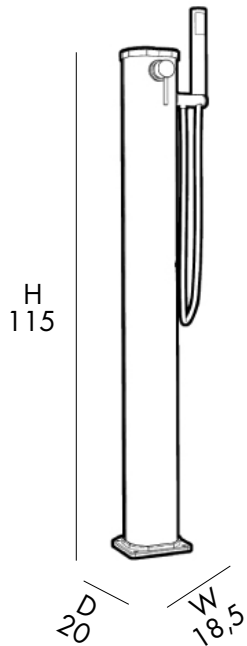

FONTANA TRADIZIONALE

- MISCELATORE
- DOCCETTA
- REALIZZATA IN ALLUMINIO VERNICIATO A POLVERE
- ACCESSORI IN OTTONE ABS CROMATO
- ATTACCO DELLA FONTANA LATERALE SINISTRO



TRADITIONAL FOUNTAIN

- MIXER
- HAND SHOWER
- MADE OF POWDER COATED ALUMINIUM
- ACCESSORIES IN CHROMED BRASS AND CHROMED ABS
- LEFT SIDE FOUNTAIN ATTACHMENT

FONTAINE TRADITIONNELLE

- MITIGEUR
- DOUCHETTE
- FABRIQUÉE EN ALUMINIUM PEINT EN POUDRE
- ACCESSOIRES EN LAITON CHROMÉ ET ABS
- RACCORDEMENT DE FONTAINE COTÉ GAUCHE



FUENTE TRADITIONAL

- MESCLADOR
- DUCHA MOVIL
- REALIZADA EN ALUMINIO PINTADO EN POLVO
- ACCESORIOS DE LATÓN CROMADO Y ABS CROMO
- ACCESORIO DE FUENTE DEL LADO IZQUIERDA



COLORS

STANDARD COLORS ALUMINIUM

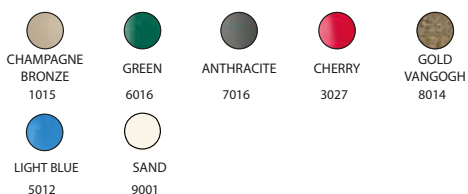

SPECIAL COLORS ALUMINIUM



*EXTRA FOR
SPECIAL COLORS

€

JOLLY GO JG185

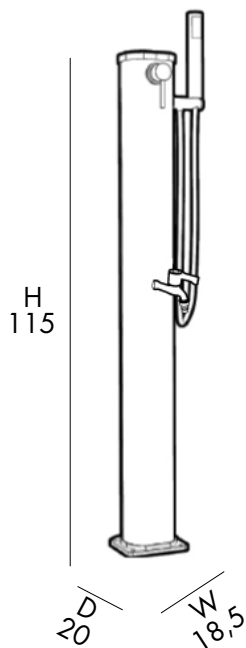

12,5 Kg



D 35 cm
H 125 cm
W 28 cm



FONTANA TRADIZIONALE

- MISCELATORE • RUBINETTO PORTA GOMMA
- DOCCETTA
- REALIZZATA IN ALLUMINIO VERNICIATO A POLVERE
- ACCESSORI IN OTTONE ABS CROMATO
- ATTACCO DELLA FONTANA LATERALE SINISTRO

TRADITIONAL FOUNTAIN

- MIXER • GARDEN TAP
- HAND SHOWER
- MADE OF POWDER COATED ALUMINIUM
- ACCESSORIES IN CHROMED BRASS AND CHROMED ABS
- LEFT SIDE FOUNTAIN ATTACHMENT

FONTAINE TRADITIONNELLE

- MITIGEUR • ROBINET TUYAU
- DOUCHETTE
- FABRIQUÉE EN ALUMINIUM PEINT EN POUVRE
- ACCESSOIRES EN LAITON CHROMÉ ET ABS
- RACCORDEMENT DE FONTAINE COTÉ GAUCHE

FUENTE TRADITIONAL

- MESCLADOR • GRIFO DE MANGUERA
- DOUCHA MOVIL
- REALIZADA EN ALUMINIO PINTADO EN POLVO
- ACCESORIOS DE LATÓN CROMADO Y ABS CROMO
- ACCESORIO DE FUENTE DEL LADO IZQUIERDA



COLORS

STANDARD COLORS ALUMINIUM

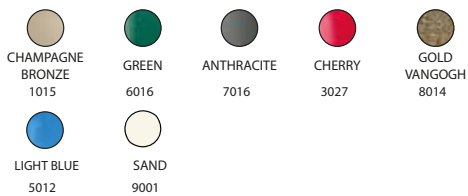

SPECIAL COLORS ALUMINIUM



*EXTRA FOR
SPECIAL COLORS



JOLLY LAVAPIEDI A685

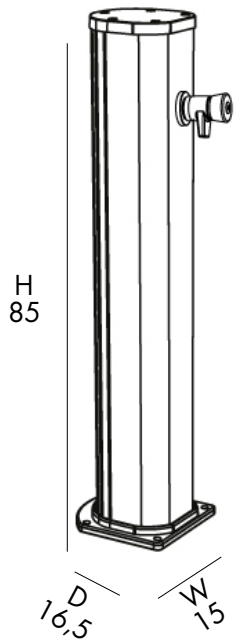

6,5 Kg



D 30 cm
H 90 cm
W 17 cm

FONTANA TRADIZIONALE

- LAVAPIEDI TEMPORIZZATO
- REALIZZATA IN ALLUMINIO VERNICIATO A POLVERE
- ACCESSORI IN OTTONE ABS CROMATO
- ATTACCO DELLA FONTANA LATERALE DESTRO
- SOLO ACQUA FREDDA



TRADITIONAL FOUNTAIN

- TEMPORIZED FOOTWASHER
- MADE OF POWDER COATED ALUMINIUM
- ACCESSORIES IN CHROMED BRASS AND CHROMED ABS
- RIGHT SIDE FOUNTAIN ATTACHMENT
- ONLY COLD WATER

FONTAINE TRADITIONNELLE

- RINCE PIEDS TEMPORISÉ
- FABRIQUÉE EN ALUMINIUM PEINT EN POUDRE
- ACCESSOIRES EN LAITON CHROMÉ ET ABS
- RACCORDEMENT DE FONTAINE COTÉ DROIT
- EAU FROIDE UNIQUEMENT



FUENTE TRADITIONAL

- LAVAPIES TEMPORIZADO
- REALIZADA EN ALUMINIO PINTADO EN POLVO
- ACCESORIOS DE LATÓN CROMADO Y ABS CROMO
- ACCESORIO DE FUENTE DEL LADO DERECHO
- SÓLO AGUA FRÍA



COLORS

STANDARD COLORS ALUMINIUM

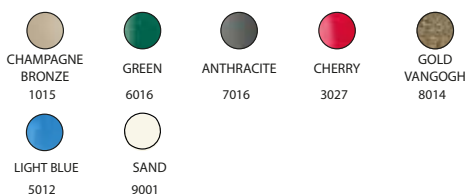

SPECIAL COLORS ALUMINIUM



*EXTRA FOR
SPECIAL COLORS



JOLLY FONTANA A695

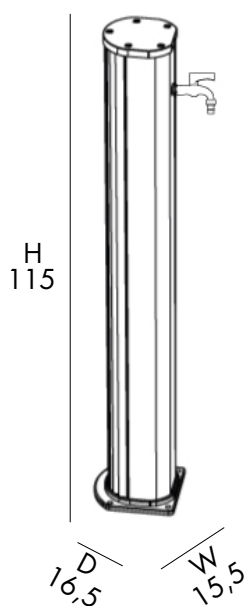

7,5 Kg



D 30 cm
H 130 cm
W 17 cm

FONTANA TRADIZIONALE

- RUBINETTO PORTA GOMMA
- REALIZZATA IN ALLUMINIO VERNICIATO A POLVERE
- ACCESSORI IN OTTONE ABS CROMATO
- ATTACCO DELLA FONTANA LATERALE DESTRO
- SOLO ACQUA FREDDA



TRADITIONAL FOUNTAIN

- GARDEN TAP
- MADE OF POWDER COATED ALUMINIUM
- ACCESSORIES IN CHROMED BRASS AND CHROMED ABS
- RIGHT SIDE FOUNTAIN ATTACHMENT
- ONLY COLD WATER

FONTAINE TRADITIONNELLE

- ROBINET TUYAU
- FABRIQUÉE EN ALUMINIUM PEINT EN POUDRE
- ACCESSOIRES EN LAITON CHROMÉ ET ABS
- RACCORDEMENT DE FONTAINE COTÈ DROIT
- EAU FROIDE UNIQUEMENT



FUENTE TRADITIONAL

- GRIFO DE MANGUERA
- REALIZADA EN ALUMINIO PINTADO EN POLVO
- ACCESORIOS DE LATÓN CROMADO Y ABS CROMO
- ACCESORIO DE FUENTE DEL LADO DERECHO
- SÓLO AGUA FRÍA



COLORS

STANDARD COLORS ALUMINIUM

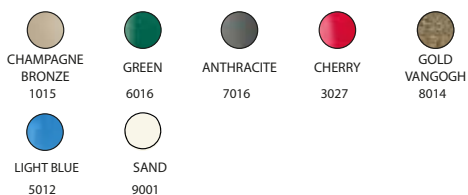

SPECIAL COLORS ALUMINIUM



*EXTRA FOR
SPECIAL COLORS



SPRING FONTANA AS345

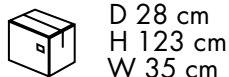
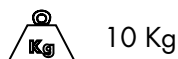
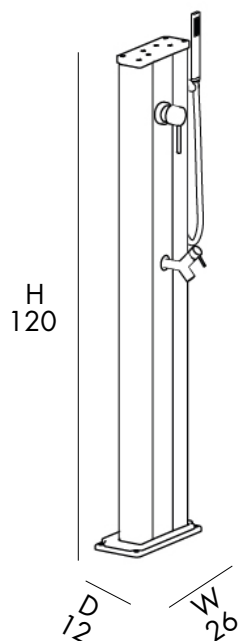

H
120

10 Kg

D 28 cm
H 123 cm
W 35 cm



FONTANA TRADIZIONALE

- RUBINETTO PORTA GOMMA
- REALIZZATA IN ALLUMINIO VERNICIATO A POLVERE
- ACCESSORI IN OTTONE ABS CROMATO
- ATTACCO DELLA FONTANA POSTERIORE



TRADITIONAL FOUNTAIN

- GARDEN TAP
- MADE OF POWDER COATED ALUMINIUM
- ACCESSORIES IN CHROMED BRASS AND CHROMED ABS
- REAR FOUNTAIN ATTACHMENT



FONTAINE TRADITIONNELLE

- ROBINET TUYAU
- FABRIQUÉE EN ALUMINIUM PEINT EN POUDRE
- ACCESSOIRES EN LAITON CHROMÉ ET ABS
- RACCORDEMENT DE FONTAINE ARRIÈRE



FUENTE TRADICIONAL

- GRIFO DE MANGUERA
- REALIZADA EN ALUMINIO PINTADO EN POLVO
- ACCESORIOS DE LATÓN CROMADO Y ABS CROMO
- ACCESORIO DE FUENTE TRASERA





**COLLETTORI
SOLARI**

**SOLAR
COLLECTOR**



QUALE SCEGLIERE? WHICH ONE TO CHOSE?

HOT BALL

Hot Ball serie 2.00 è un collettore solare dal design innovativo, facile da installare e trasportare che, grazie alla sua forma riesce a sfruttare al massimo l'irradiazione solare.

Realizzata in polietilene termoindurente resistente al calcare e alle correnti galvaniche acide.

L'innovativa struttura la rende praticamente indistruttibile e quindi adatta all'utilizzo in condizioni di emergenza (es. protezione civile etc).

Permette di avere acqua calda dove serve senza sprechi e costi di energia: dal giardino al campeggio, alle grandi manifestazioni, l'allevamento, spiagge e hotel, eventi di ogni genere, un perfetto di supporto al barbecue, per il camper o per lavare gli animali domestici.

- HB 200 per docce, lavandini o erogatori predisposti con miscelazione calda e fredda
- HB 240 con miscelatore per docce, lavandini o erogatori senza miscelatore calda fredda
- HB 270 con miscelatore termostatico per docce, lavandini o erogatori dove si desidera una temperatura programmata.

La versione Hybrid o /80 è una soluzione unica sul mercato per uso professionale, in quanto è in grado di garantire acqua calda in ogni condizione climatica.

Accessorio utile a tutti coloro che per lavoro o svago vivono gli spazi esterni.

- HB 200/80 (idem) per utilizzo anche notturno e invernale o in assenza di sole.
- HB 240/80 (idem) per utilizzo anche notturno e invernale o in assenza di sole.
- HB 270/80 (idem) per utilizzo anche notturno e invernale o in assenza di sole.

HOT BALL

Hot Ball Series 2.00 is a solar collector with an innovative design, which thanks to its shape makes maximum use of sunlight radiation. Easy to install and to transport.

It is made of thermosetting polyethylene which is resistant to limescale and galvanic acid currents.

The innovative structure makes it practically indestructible and therefore suitable for use in emergency conditions (e.g. civil protection etc.).

Allows to have hot water wherever you need it without waste and energy costs: from the garden to the campsite, to large-scale events on beaches and in hotels, in your garden for showering, washing pets or whatever else, perfect support for your barbecue or motorhome.

- HB 200 for showers, washbasins or dispensers prepared with hot and cold mixers
- HB 240 with mixer for showers, washbasins or dispensers without hot-cold mixer
- HB 270 with thermostatic mixer for showers, washbasins or spouts where a programmed temperature is desired.

The Hybrid /80 version is a unique solution on the market for professional use, as it is able to guarantee hot water in all weather conditions.

A useful accessory for all those who experience outdoor spaces for work or leisure.

- HB 200/80 ditto for use at night and in winter or in the absence of sunlight.
- HB 240/80 ditto for use at night and in winter or in the absence of sunlight.
- HB 270/80 ditto for use at night and in winter or in the absence of sunlight.

LEQUEL CHOISIR? ¿CUÁL ELEGIR?

HOT BALL

Hot Ball Series 2.00 est un capteur solaire au design innovant, facile à installer et à transporter, qui, grâce à sa forme, exploite au maximum le rayonnement solaire.

Il est fabriqué en polyéthylène thermodurcissable résistant au calcaire et aux courants galvaniques acides.

Sa structure innovante le rend pratiquement indestructible et donc apte à être utilisé dans des conditions d'urgence (par exemple, protection civile, etc.).

Disposez d'eau chaude là où vous en avez besoin, sans gaspillage ni coûts énergétiques, du jardin au camping en passant par les grandes manifestations plages et hôtels, événements de toutes sortes, dans votre jardin pour prendre une douche, laver les animaux domestiques ou autre, support parfait pour votre barbecue ou votre camping-car.

- HB 200 pour douches, lavabos ou distributeurs préparés avec mélangeur chaud et froid
- HB 240 avec mélangeur pour douches, lavabos ou distributeurs sans mélangeur chaud-froid
- HB 270 avec mélangeur thermostatique pour douches, lavabos ou bacs où une température programmée est souhaitée.

La version Hybrid /80 est une solution unique sur le marché pour un usage professionnel, car elle est capable de garantir de l'eau chaude dans toutes les conditions climatiques.

Un accessoire utile pour tous ceux qui fréquentent les espaces extérieurs pour le travail ou les loisirs.

- HB 200/80 idem pour une utilisation de nuit et en hiver ou en l'absence de lumière solaire.
- HB 240/80 idem pour une utilisation de nuit et en hiver ou en l'absence de lumière solaire.
- HB 270/80 idem pour une utilisation de nuit et en hiver ou en l'absence de lumière solaire.

HOT BALL

Hot Ball Series 2.00 es un colector solar con un diseño innovador, fácil de instalar y transportar, que gracias a su forma aprovecha al máximo la radiación solar.

Está fabricado en polietileno termoendurecible resistente a la cal y a las corrientes galvánicas ácidas.

Su innovadora estructura la hace prácticamente indestructible y, por tanto, adecuada para su uso en condiciones de emergencia (por ejemplo, protección civil, etc.).

Disponga de agua caliente donde la necesite sin derroches ni costes energéticos, desde el jardín al camping pasando por grandes eventos playas y hoteles, eventos de todo tipo, en su jardín para ducharse, lavar mascotas o cualquier otra cosa, soporte perfecto para su barbacoa o autocaravana.

- HB 200 para duchas, lavabos o dispensadores preparados con mezclador de agua caliente y fría
- HB 240 con mezclador para duchas, lavabos o dispensadores sin mezclador frío-calor
- HB 270 con mezclador termostático para duchas, lavabos o surtidores en los que se desee una temperatura programada.

La versión Hybrid /80 es una solución única en el mercado para uso profesional, ya que es capaz de garantizar agua caliente en todas las condiciones meteorológicas.

Un accesorio útil para todos aquellos que viven los espacios exteriores por motivos de trabajo o de ocio.

- HB 200/80 ídem para uso nocturno e invernal o en ausencia de luz solar.
- HB 240/80 ídem para uso nocturno e invernal o en ausencia de luz solar.
- HB 270/80 ídem para uso nocturno e invernal o en ausencia de luz solar.

L'innovazione del collettore solare

The solar collector innovation

 Nella filosofia di Arkema e Jean Rusconi, tutti prodotti sono studiati e realizzati per offrire vantaggi all'utilizzatore, senza alcuna controindicazione. Viene prestata grande attenzione al design, alla semplicità d'utilizzo e all'innovazione.

La linea Collettori raggiunge il massimo di questi obiettivi differenziandosi dagli innumerevoli prodotti esistenti.

Solar collector 2.0 rappresenta l'apice di questa filosofia, che consente un risparmio energetico e idrico, eliminando i limiti delle docce a riscaldamento solare e tradizionale, dovuti principalmente al colore, posizionamento, distanza dalla fonte di calore, generando acqua riscaldata dal sole per qualsiasi utilizzo.

SEMPLICITA' DI UTILIZZO E DI MONTAGGIO

Posizionato al sole, un collettore solare non necessita di alcun accorgimento. E' facilmente trasportabile; il collegamento dei tubi non necessita di installatori professionisti; è modulabile all'infinito permettendo di ottenere grandi quantità di acqua calda.

La differenza sostanziale dagli altri prodotti, è la resistenza al calcare, agli urti, alle cadute e a qualsiasi evento atmosferico (anche estremo) rendendolo un prodotto unico insuperabile anche nella versione Hybrid.

 In the philosophy of Arkema and Jean Rusconi, all products are designed and manufactured to offer benefits to the user without any counterindications. Great attention is paid to design, ease of use and innovation.

The manifold line achieves the maximum of these objectives by differentiating itself from the countless existing products.

Solar Collector 2.0 represents the pinnacle of this philosophy, which allows energy and water savings, eliminating limits of solar and traditional heated showers mainly due to the color, positioning, distance from the heat source, generating water heated by the sun for any use.

SIMPLICITY OF USE AND ASSEMBLY

Positioned in the sun, a solar collector does not require any precautions. It is easily transportable; the connection of the pipes does not require professional installers; it can be modulated infinitely allowing you to obtain large quantities of hot water.

The main difference from the other products is the resistance to limestone, to impacts, and to any atmospheric event (even extreme) making it a unique product that cannot be beaten even in the hybrida version.

L'innovation en matière de capteurs solaires

La innovación en colectores solares



Dans la philosophie d'Arkema et de Jean Rusconi, tous les produits sont conçus et fabriqués pour offrir des avantages à l'utilisateur, sans aucune contre-indication. Une grande attention est accordée au design, à la facilité d'utilisation et à l'innovation.

La ligne Collector atteint le maximum de ces objectifs en se différenciant des innombrables produits existants.

Le capteur solaire 2.0 représente le summum de cette philosophie, qui permet des économies d'énergie et d'eau, éliminant les limites des douches à chauffage solaires et traditionnelles, principalement en raison de la couleur, du positionnement, de la distance de la source de chaleur, générant de l'eau chauffée par le soleil pour toute utilisation.

SIMPLICITÉ D'UTILISATION ET DE MONTAGE

Positionné au soleil, un capteur solaire ne nécessite aucune précaution, il est facilement transportable ; le raccordement des tuyaux ne nécessite pas d'installateurs professionnels; il peut être modulé à l'infini, vous permettant d'obtenir de grandes quantités d'eau chaude.

La principale différence avec les autres produits est la résistance au calcaire, aux chocs, aux chutes et à tout événement atmosphérique (même extrême) ce qui en fait un produit unique et inégalé même dans la version hybrida.



En la filosofía de Arkema y Jean Rusconi, todos los productos están diseñados y fabricados para ofrecer beneficios al usuario, sin contraindicaciones. Se presta gran atención al diseño, la facilidad de uso y la innovación.

La línea de Colectores logra el máximo de estos objetivos diferenciándose de los innumerables productos existentes.

El colector solar 2.0 representa la cúspide de esta filosofía, que permite ahorrar energía y agua, eliminando los límites de las duchas solares y tradicionales calentadas, principalmente por el color, posicionamiento, distancia de la fuente de calor, generando agua calentada por el sol para cualquier uso.

SIMPLICIDAD DE USO Y MONTAJE

Colocado al sol, un colector solar no requiere precauciones, es fácilmente transportable; la conexión de las tuberías no requiere instaladores profesionales; se puede modular infinitamente, lo que le permite obtener grandes cantidades de agua caliente.

La principal diferencia con el resto de productos es la resistencia a la piedra caliza, a los impactos, a las caídas y a cualquier evento atmosférico (incluso extremo) lo que lo convierte en un producto único e insuperable incluso en la versión híbrida.

APPLICAZIONI APPLICATIONS



MODALITÀ DI UTILIZZO METHOD OF USE

HOT BALL 200 - 240 - 270

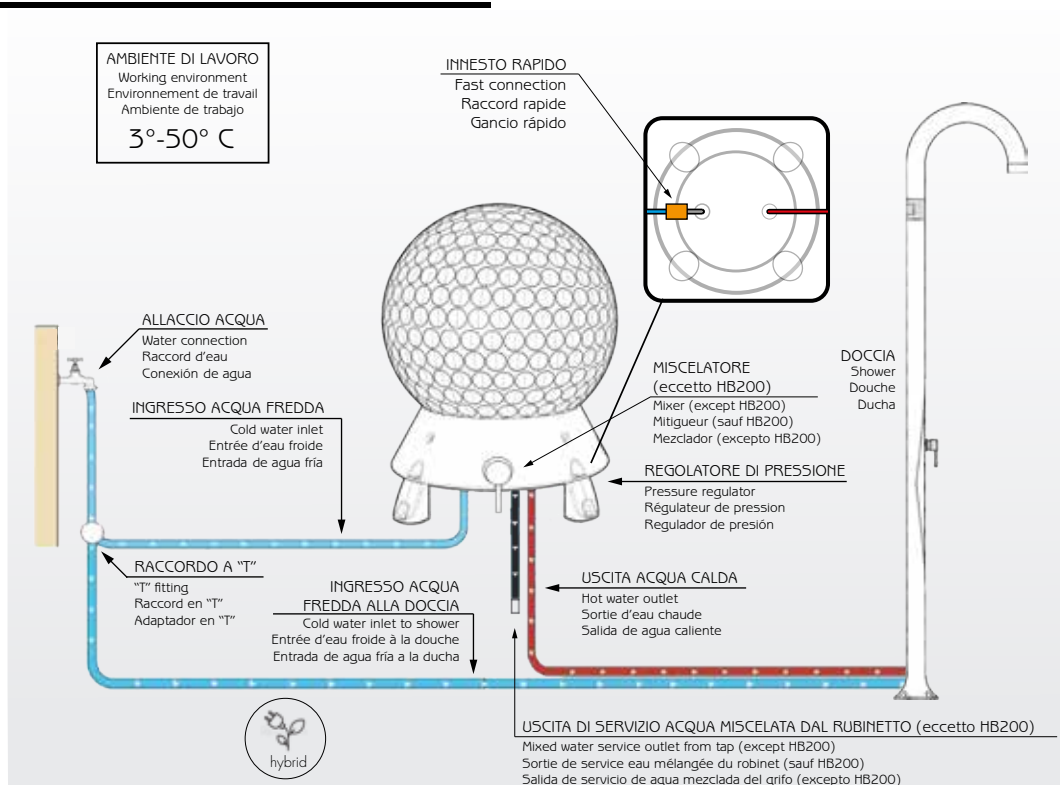

HOT BALL 200/80 - 240/80 - 270 - 270/80

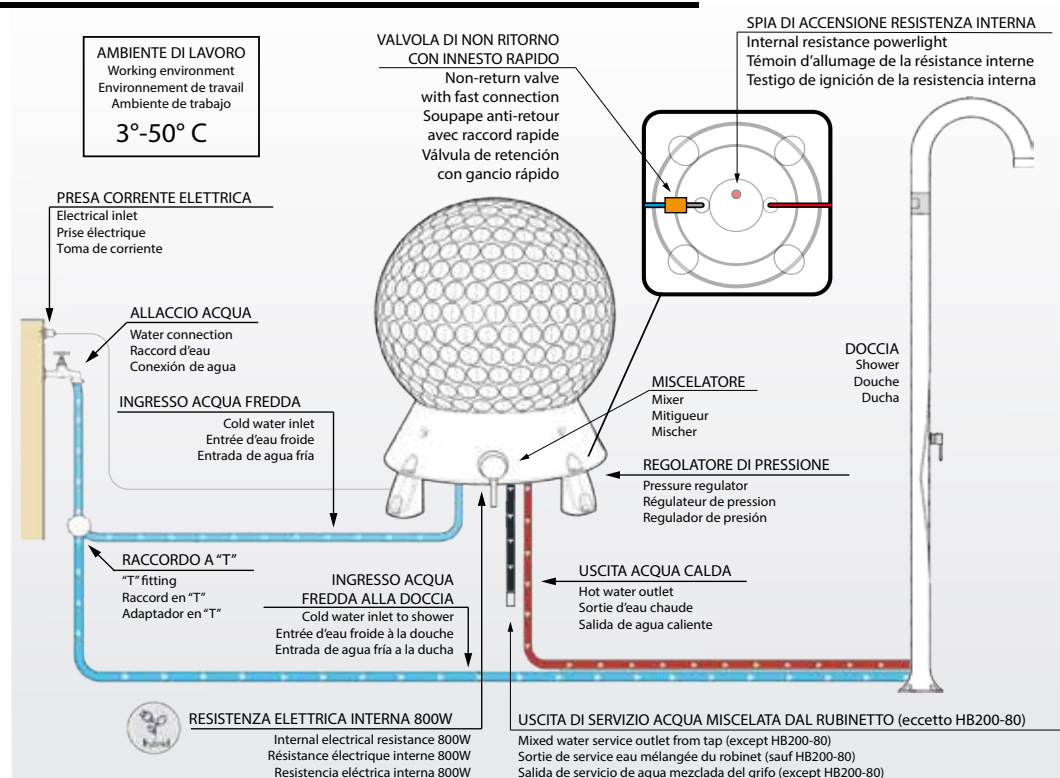

COLLECTOR COLORS

●
ANTHRACITE
7016

HB200



40 Lt



8 Kg



D 41 cm
H 52 cm
W 41 cm

Per docce/fontane o altri dispositivi dotati di miscelatore.

For showers/fountains or other devices equipped with a mixer.

Pour les douches/fontaines ou autres appareils équipés d'un mélangeur.

Para duchas/fuentes u otros aparatos equipados con mezclador.



COLLETTORE SOLARE

- COLLETTORE SOLARE PER ACQUA SANITARIA
- ATTACCO 1/2
- REGOLATORE DI PRESSIONE 3 BAR

UK SOLAR COLLECTOR

- SOLAR COLLECTOR FOR SANITARY WATER
- CONNECTION 1/2 INCH
- PRESSURE REGULATOR 3 BAR

COLLECTEUR SOLAIRE

- COLLECTEUR SOLAIRE POUR L'EAU SANITAIRE
- RACCORD 1/2
- RÉGULATEUR DE PRESSION 3 BAR

COLECTOR SOLAR

- COLECTOR SOLAR PARA AGUA SANITARIA
- CONEXION DE 1/2
- REGULADOR DE PRESIÓN DE 3 BAR



COLLECTOR COLORS

●
ANTHRACITE
7016

HB240

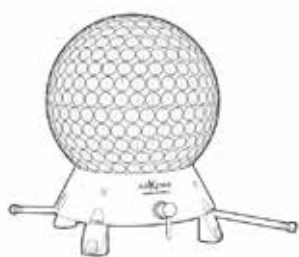

 40 Lt

 8 Kg

 D 41 cm
H 52 cm
W 41 cm

Per docce/fontane o altri dispositivi NON dotati di miscelatore.

For showers/fountains or other devices NOT fitted with a mixer.

Pour les douches/fontaines ou autres dispositifs NON équipés d'un mélangeur.

Para duchas/fuentes u otros aparatos NO equipados con mezclador.



COLLETTORE SOLARE

- COLLETTORE SOLARE PER ACQUA SANITARIA
- ATTACCO 1/2
- REGOLATORE DI PRESSIONE 3 BAR
- MIXER ACQUA CALDA/FREDDA

SOLAR COLLECTOR

- SOLAR COLLECTOR FOR SANITARY WATER
- CONNECTION 1/2 INCH
- PRESSURE REGULATOR 3 BAR
- HOT/COLD WATER MIXER

COLLECTEUR SOLAIRE

- COLLECTEUR SOLAIRE POUR L'EAU SANITAIRE
- RACCORD 1/2
- RÉGULATEUR DE PRESSION 3 BAR
- MÉLANGEUR EAU CHAUDE/FROIDE

COLECTOR SOLAR

- COLECTOR SOLAR PARA AGUA SANITARIA
- CONEXION DE 1/2
- REGULADOR DE PRESIÓN DE 3 BAR
- MEZCLADOR AGUA FRIA/CALIENTE



COLLECTOR COLORS

●
ANTHRACITE
7016

HB270



40 Lt



8 Kg



D 41 cm
H 52 cm
W 41 cm

Per docce/fontane o altri dispositivi NON dotati di miscelatore.

For showers/fountains or other devices NOT fitted with a mixer.

Pour les douches/fontaines ou autres dispositifs NON équipés d'un mélangeur.

Para duchas/fuentes u otros aparatos NO equipados con mezclador.

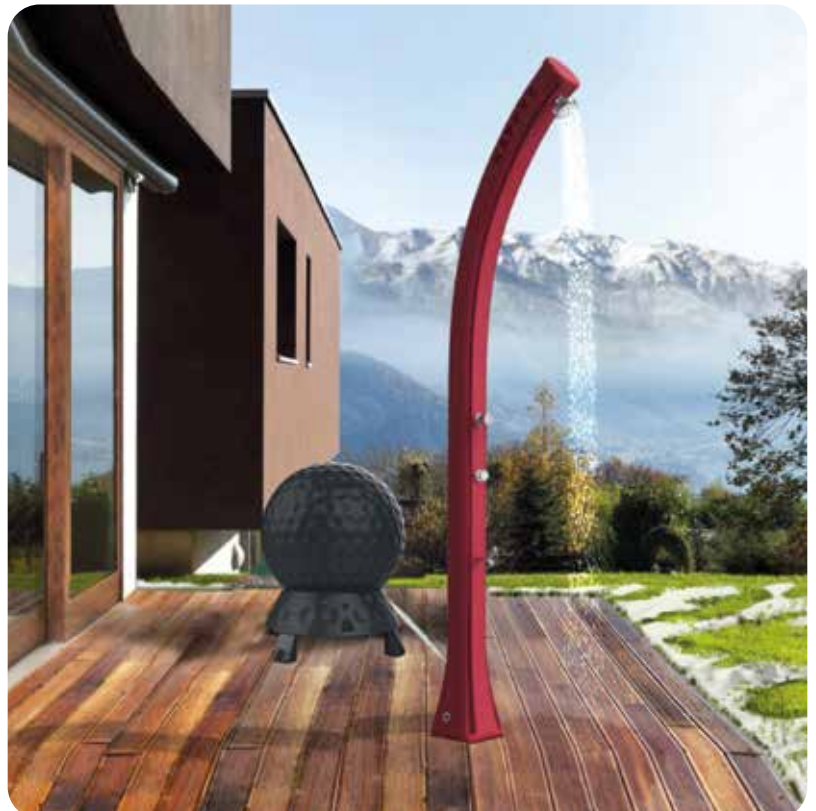

COLLETTORE SOLARE

- COLLETTORE SOLARE PER ACQUA SANITARIA
- ATTACCO 1/2
- REGOLATORE DI PRESSIONE 3 BAR
- MIXER ACQUA CALDA/FREDDA
- REGOLATORE TERMOSTATICO



SOLAR COLLECTOR

- SOLAR COLLECTOR FOR SANITARY WATER
- CONNECTION 1/2 INCH
- PRESSURE REGULATOR 3 BAR
- HOT/COLD WATER MIXER
- THERMOSTATIC REGULATOR

COLLECTEUR SOLAIRE

- COLLECTEUR SOLAIRE POUR L'EAU SANITAIRE
- RACCORD 1/2
- RÉGULATEUR DE PRESSION 3 BAR
- MÉLANGEUR EAU CHAUDE/FROIDE
- RÉGULATEUR THERMOSTATIQUE



COLECTOR SOLAR

- COLECTOR SOLAR PARA AGUA SANITARIA
- CONEXION DE 1/2
- REGULADOR DE PRESIÓN DE 3 BAR
- MEZCLADOR AGUA FRIA/CALIENTE
- REGULADOR THEMOSTÁTICO

COLLECTOR COLORS

●
ANTHRACITE
7016

HB200/80



 40 Lt

 9 Kg

 D 41 cm
H 52 cm
W 41 cm

Come HB200, per utilizzo giorno/notte ed estate/inverno

Like HB200, for day/night and summer/winter use

Comme le HB200, pour l'utilisation jour/nuit et été/hiver

Como HB200, para uso diurno/nocturno y verano/invierno



COLLETTORE SOLARE

- COLLETTORE SOLARE PER ACQUA SANITARIA
- ATTACCO 1/2
- REGOLATORE DI PRESSIONE 3 BAR
- SISTEMA ELETTRICO (- 800 WATT IP 65 EU - 220 VOLT 50 HZ - USA 110 VOLT 60 HZ)

UK SOLAR COLLECTOR

- SOLAR COLLECTOR FOR SANITARY WATER
- CONNECTION 1/2
- PRESSURE REGULATOR 3 BAR
- ELETRIC SYSTEM (- 800 WATT IP 65 EU - 220 VOLT 50 HZ - USA 110 VOLT 60 HZ)

COLLECTEUR SOLAIRE

- COLLECTEUR SOLAIRE POUR L'EAU SANITAIRE
- RACCORD 1/2 INCH
- RÉGULATEUR DE PRESSION 3 BAR
- SYSTÈME ÉLECTRIQUE (- 800 WATT IP 65 EU - 220 VOLT 50 HZ - USA 110 VOLT 60 HZ)

COLECTOR SOLAR

- COLECTOR SOLAR PARA AGUA SANITARIA
- CONEXION DE 1/2
- REGULADOR DE PRESIÓN DE 3 BAR
- SISTEMA ELÉCTRICO (- 800 WATT IP 65 EU - 220 VOLT 50 HZ - USA 110 VOLT 60 HZ)



COLLECTOR COLORS

●
ANTHRACITE
7016

HB240/80



40 Lt



9 Kg



D 41 cm
H 52 cm
W 41 cm

Come HB240, per utilizzo giorno/notte ed estate/inverno

Like HB240, for day/night and summer/winter use

Comme le HB240, pour l'utilisation jour/nuit et été/hiver

Como HB240, para uso diurno/nocturno y verano/invierno



COLLETTORE SOLARE

- COLLETTORE SOLARE PER ACQUA SANITARIA
- ATTACCO 1/2
- REGOLATORE DI PRESSIONE 3 BAR
- MIXER ACQUA CALDA/FREDDA
- SISTEMA ELETTRICO (- 800 WATT IP 65 EU - 220 VOLT 50 HZ - USA 110 VOLT 60 HZ)



SOLAR COLLECTOR

- SOLAR COLLECTOR FOR SANITARY WATER
- CONNECTION 1/2 INCH
- PRESSURE REGULATOR 3 BAR
- HOT/COLD WATER MIXER
- ELETRIC SYSTEM (- 800 WATT IP 65 EU - 220 VOLT 50 HZ - USA 110 VOLT 60 HZ)

COLLECTEUR SOLAIRE

- COLLECTEUR SOLAIRE POUR L'EAU SANITAIRE
- RACCORD 1/2
- RÉGULATEUR DE PRESSION 3 BAR
- MÉLANGEUR EAU CHAUDE/FROIDE
- SYSTÈME ÉLECTRIQUE (- 800 WATT IP 65 EU - 220 VOLT 50 HZ - USA 110 VOLT 60 HZ)



COLECTOR SOLAR

- COLECTOR SOLAR PARA AGUA SANITARIA
- CONEXION DE 1/2
- REGULADOR DE PRESIÓN DE 3 BAR
- MEZCLADOR AGUA FRIA/CALIENTE
- SISTEMA ELÉCTRICO (- 800 WATT IP 65 EU - 220 VOLT 50 HZ - USA 110 VOLT 60 HZ)





COLLECTOR COLORS

●
ANTHRACITE
7016

HB270/80



 40 Lt

 9 Kg

 D 41 cm
H 52 cm
W 41 cm

Come HB270, per utilizzo giorno/notte ed estate/inverno

Like HB270, for day/night and summer/winter use

Comme le HB270, pour l'utilisation jour/nuit et été/hiver

Como HB270, para uso diurno/nocturno y verano/invierno



COLLETTORE SOLARE

- COLLETTORE SOLARE PER ACQUA SANITARIA
- ATTACCO 1/2 • REGOLATORE DI PRESSIONE 3 BAR
- MIXER ACQUA CALDA/FREDDA
- REGOLATORE TERMOSTATICO
- SISTEMA ELETTRICO (- 800 WATT IP 65 EU - 220 VOLT 50 HZ - USA 110 VOLT 60 HZ)

SOLAR COLLECTOR

- SOLAR COLLECTOR FOR SANITARY WATER
- CONNECTION 1/2 • PRESSURE REGULATOR 3 BAR
- HOT/COLD WATER MIXER
- THERMOSTATIC REGULATOR
- ELETRIC SYSTEM (- 800 WATT IP 65 EU - 220 VOLT 50 HZ - USA 110 VOLT 60 HZ)

COLLECTEUR SOLAIRE

- COLLECTEUR SOLAIRE POUR L'EAU SANITAIRE
- RACCORD 1/2 • RÉGULATEUR DE PRESSION 3 BAR
- MÉLANGEUR EAU CHAUDE/FROIDE
- RÉGULATEUR THERMOSTATIQUE
- SYSTÈME ÉLECTRIQUE (- 800 WATT IP 65 EU - 220 VOLT 50 HZ - USA 110 VOLT 60 HZ)

COLECTOR SOLAR

- COLECTOR SOLAR PARA AGUA SANITARIA
- CONEXION DE 1/2 • REGULADOR DE PRESIÓN DE 3 BAR
- MEZCLADOR AGUA FRIA/CALIENTE
- REGULADOR THEMOSTÁTICO
- SISTEMA ELÈCTRICO - 800 WATT IP 65 EU - 220 VOLT 50 HZ - USA 110 VOLT 60 HZ



QUANDO SCEGLIERE SUNKEPT? WHEN SHOULD ONE CHOOSE THE SUNKEPT?

SUN KEPT

- Sun kept serie 1.00 risolve tutti i problemi dei tradizionali scambiatori solari, realizzato in speciali resine termoindurenti, non è attaccabile da calcare o correnti galvaniche acide, è praticamente indistruttibile, può essere facilmente trasportabile, si mette in funzione in meno di un minuto e non necessita di particolari spazi.
- La sua forma le consente di sfruttare al massimo l'irradiazione solare, senza nessuna attenzione al posizionamento, può anche essere usato come seduta, un accessorio utile a tutti coloro che vogliono sfruttare al massimo la loro piscina allungandone la stagionalità, senza costi e manutenzioni. La sua forma e lo speciale design superficiale le consente di non essere aggredibile, anche in condizioni atmosferiche estreme, a differenza di tutti gli altri prodotti sul mercato.
- Siamo certi di aver realizzato un prodotto unico, innovativo, di indiscutibile utilità e funzionalità. Oltre alla piscina può essere anche utilizzato per impianti di riscaldamento e scambiatori di calore.
- Collegabili in serie o in parallelo, possono produrre acqua calda secondo le necessità, come tutti i prodotti di questo tipo, SK100 può essere utilizzata solo su circuiti aperti e non deve mai andare in pressione: in ogni caso una valvola di sicurezza salvaguarda il prodotto in caso di errori o incidenti.
- Questo particolare prodotto viene utilizzato per riscaldare la superficie delle piscine.
- Una Sunkept può riscaldare una piscina di 2x3m.

SUN KEPT

- Sun kept series 1.00 solves all the problems of traditional solar heat exchangers. It is made of special thermosetting resins which cannot be attacked by acid galvanic currents and is practically indestructible. It can be easily transported and is ready to use in less than a minute, and does not require any special space.
- Its shape allows to make the most of the sun's rays, without any attention to positioning and can also be used as a seat. A useful accessory for all those who want to make the most of their pool by extending its seasonality, without costs and maintenance. Its shape and special surface design mean that it is not susceptible to any sort of damage, even in extreme weather conditions, unlike all the other products on the market.
- We are confident that we created a unique, innovative product of unquestionable utility and functionality, that in addition to the pool, can also be used for heating systems and heat exchangers.
- It can be connected in series or in parallel and can produce hot water as required. Like all products of this type, SK100 can only be used on open circuits and must never be pressurised. In all cases a safety valve safeguards the product in the event of errors or accidents.
- This particular product is used to heat the surface of swimming pools.
- A Sunkept can heat a 2x3m pool.

QUAND CHOISIR SUNKEPT? ¿CUÁNDO ELEGIR SUNKEPT?

SUN KEPT

- Sun kept série 1.00 résout tous les problèmes des échangeurs de chaleur solaires traditionnels: il est réalisé avec des résines thermodurcissables spéciales, il n'est pas attaqué par les courants galvaniques acides, il est pratiquement indestructible, il peut être facilement transporté, il est prêt à être utilisé en moins d'une minute et il ne nécessite pas d'espace particulier.
- Sa forme lui permet de profiter au maximum des rayons du soleil, sans aucune attention au positionnement, et il peut également être utilisé comme siège, un accessoire utile pour tous ceux qui veulent profiter au maximum de leur piscine en prolongeant sa saisonnalité, sans coûts et sans entretien. Sa forme et la conception spéciale de sa surface font qu'il n'est pas susceptible d'être attaqué, même dans des conditions climatiques extrêmes, contrairement à tous les autres produits du marché.
- Nous sommes convaincus d'avoir créé un produit unique et innovant, d'une utilité et d'une fonctionnalité incontestables, qui, outre la piscine, peut également être utilisé pour les systèmes de chauffage et les échangeurs de chaleur.
- Comme tous les produits de ce type, le SK100 ne peut être utilisé que sur des circuits ouverts et ne doit jamais être sous pression ; dans tous les cas, une soupape de sécurité protège le produit en cas d'erreur ou d'accident.
- Ce produit est utilisé pour chauffer la surface des piscines.
- Un Sunkept peut chauffer une piscine de 2x3m.

SUN KEPT

- Sun kept serie 1.00 resuelve todos los problemas de los intercambiadores solares tradicionales. Está fabricado con resinas termoendurecibles especiales, no lo atacan las corrientes galvánicas ácidas, es prácticamente indestructible, se puede transportar fácilmente y está listo para usar en menos de un minuto, y no requiere ningún espacio especial.
- Su forma le permite aprovechar al máximo los rayos del sol, sin tener que prestar atención a su colocación, y también puede utilizarse como asiento, un accesorio útil para todos aquellos que quieran sacar el máximo partido a su piscina ampliando su estacionalidad, sin costes ni mantenimiento. Su forma y el diseño especial de su superficie hacen que no sea susceptible de sufrir ataques, incluso en condiciones climáticas extremas, a diferencia de todos los demás productos del mercado.
- Estamos seguros de haber creado un producto único, innovador y de indudable utilidad y funcionalidad que, además de para la piscina, puede utilizarse para sistemas de calefacción e intercambiadores de calor.
- Se pueden conectar en serie o en paralelo y pueden producir agua caliente según las necesidades. Como todos los productos de este tipo, SK100 sólo se puede utilizar en circuitos abiertos y nunca debe estar presurizado, en todos los casos una válvula de seguridad salvaguarda el producto en caso de errores o accidentes.
- Este producto se utiliza para calentar la superficie de las piscinas.
- Un Sunkept puede calentar una piscina de 2x3m.

APPLICAZIONI APPLICATION

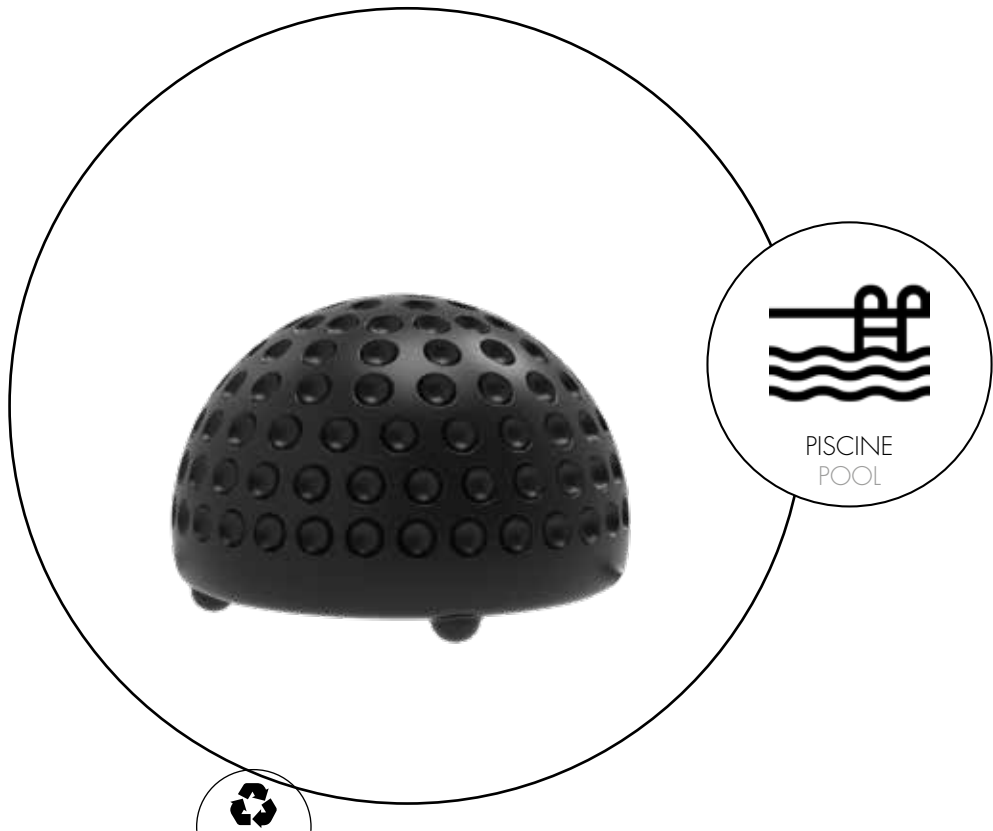

MODALITÀ D'UTILIZZO METHOD OF USE

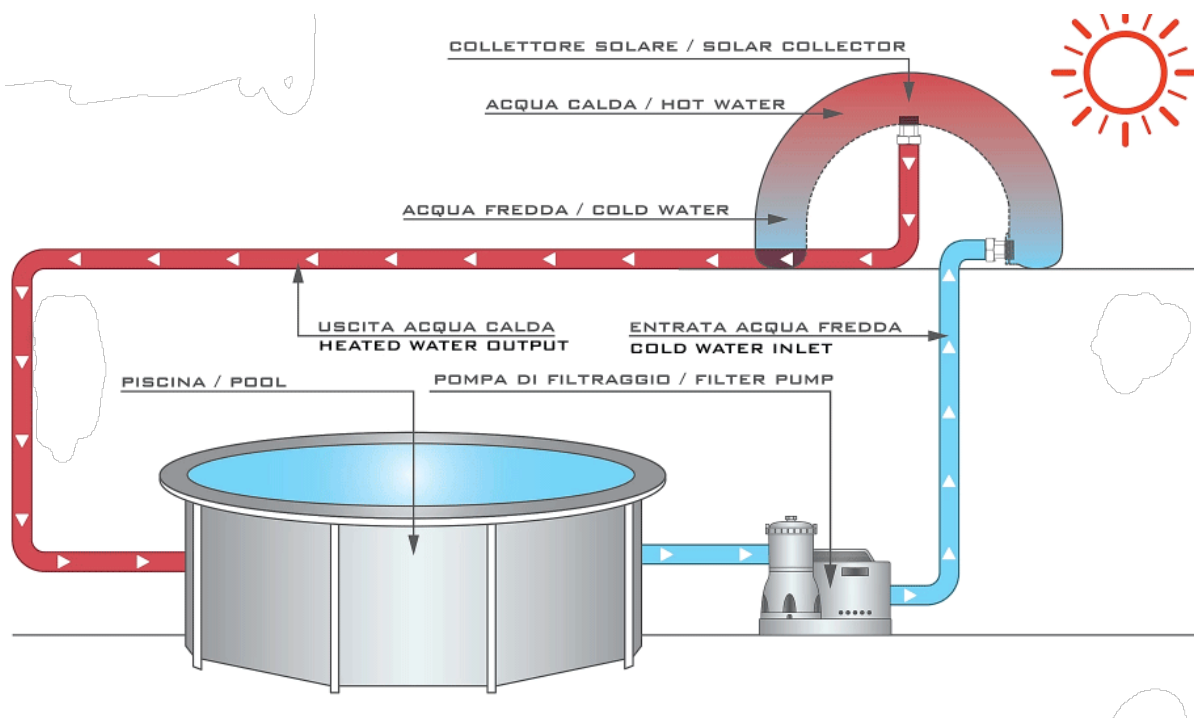

COLLECTOR COLORS

●
ANTHRACITE
7016

SK100

COLLETTORE SOLARE

- COLLETTORE SOLARE PER ACQUA SANITARIA
- ATTACCO 1
- REGOLATORE DI PRESSIONE 1 BAR

UK SOLAR COLLECTOR

- SOLAR COLLECTOR FOR SANITARY WATER
- CONNECTION 1 INCH
- PRESSURE REGULATOR 1 BAR

COLLECTEUR SOLAIRE

- COLLECTEUR SOLAIRE POUR L'EAU SANITAIRE
- RACCORD 1
- RÉGULATEUR DE PRESSION 1 BAR

COLECTOR SOLAR

- COLECTOR SOLAR PARA AGUA SANITARIA
- CONEXION DE 1
- REGULADOR DE PRESIÓN DE 1 BAR

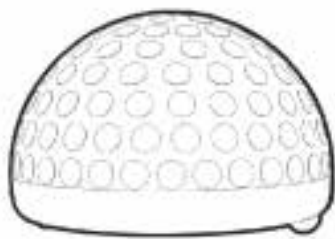

40 Lt



7 Kg



D 60 cm
H 40 cm
W 60 cm

Principalmente usate per piscine fuori terra.

Mainly used for above-ground swimming pools.

Principalement utilisé pour les piscines hors sol.

Se utiliza sobre todo para piscinas elevadas.



QUANDO SCEGLIERE EGGBALL? WHEN SHOULD ON CHOOSE THE EGGBALL?

EGGBALL

Eggball serie 2.00 è un collettore solare dal design innovativo, facile da installare e da trasportare. Come le Hotball grazie alla sua forma riesce a sfruttare al massimo l'irradiazione solare, è realizzata in polietilene termoindurente resistente al calcare e alle correnti galvaniche acide.

Consente un risparmio energetico ed idrico, eliminando i limiti delle docce a riscaldamento solare, dovuti principalmente al colore, posizionamento, distanza dalla fonte di calore, generando acqua riscaldata dal sole per qualsiasi utilizzo.

Un prodotto innovativo in linea con le nuove direttive; la risposta perfetta alle nuove esigenze del mercato distributivo e del consumatore: per ridurre i consumi energetici, riciclo dei materiali, bassi costi di trasporto.

EGGBALL

Eggball series 2.00 is a solar collector with an innovative design, easy to transport and install. Like the Hotballs, thanks to their shape, manage to make the most of solar radiation, and is made of thermosetting polyethylene which is resistant to limescale and galvanic acid currents.

The EggBall saves energy and water eliminating the limitations of solar-heated and traditional showers. Mainly due to: colour, positioning and distance from the heat source; generating heated water from the sun for any use.

An innovative product in line with the new directives for reduced energy consumption, recycling of materials and low transport costs: the perfect response to the new needs of the distribution market and the consumers.

EGGBALL

Eggball série 2.00 est un capteur solaire au design innovant, facile à installer et à transporter, comme les Hotballs grâce à sa forme il est capable de tirer le meilleur parti de la radiation solaire, il est fabriqué en polyéthylène thermodurcissable qui résiste au calcaire et aux courants galvaniques acides.

Il permet d'économiser de l'énergie et de l'eau, en éliminant les limitations des douches solaires et traditionnelles, des douches solaires et traditionnelles, principalement en raison de la couleur, du positionnement, de la distance par rapport à la source de chaleur.

source de chaleur, en générant de l'eau chauffée par le soleil pour tout usage.

Un produit innovant en ligne avec les nouvelles directives pour la réduction de la consommation d'énergie, le recyclage des matériaux, les faibles coûts de transport; la réponse parfaite aux nouveaux besoins du marché de la distribution et du consommateur.

EGGBALL

Eggball serie 2.00 es un colector solar con un diseño innovador, fácil de instalar y transportar, al igual que los Hotballs gracias a su forma es capaz de aprovechar al máximo la radiación solar, está fabricado en polietileno termoendurecible resistente a la cal y a las corrientes galvánicas ácidas.

Ahorra energía y agua, eliminando las limitaciones de las duchas solares y tradicionales, debidas principalmente al color, la colocación, la distancia a la fuente de calor fuente de calor, generando agua calentada por el sol para cualquier uso.

Un producto innovador en línea con las nuevas directivas de reducción del consumo energético, reciclaje de materiales, bajo coste de transporte; la respuesta perfecta a las nuevas necesidades del mercado de la distribución y del consumidor.

COLLECTOR COLORS

●
ANTHRACITE
7016

HE100



18 Lt



10 Kg



D 40 cm
H 50 cm
W 40 cm

Per docce/fontane o altri dispositivi dotati di miscelatore.

For showers/fountains or other devices equipped with a mixer.

Pour les douches/fontaines ou autres appareils équipés d'un mélangeur.

Para duchas/fuentes u otros aparatos equipados con mezclador.



COLLETTORE SOLARE

- COLLETTORE SOLARE PER ACQUA SANITARIA
- ATTACCO 1/2
- REGOLATORE DI PRESSIONE 3 BAR
- EFFETTO PIETRA

SOLAR COLLECTOR

- SOLAR COLLECTOR FOR SANITARY WATER
- CONNECTION 1/2 INCH
- PRESSURE REGULATOR 3 BAR
- STONE EFFECT

COLLECTEUR SOLAIRE

- COLLECTEUR SOLAIRE POUR L'EAU SANITAIRE
- RACCORD 1/2
- RÉGULATEUR DE PRESSION 3 BAR
- EFFET PIERRE

COLECTOR SOLAR

- COLECTOR SOLAR PARA AGUA SANITARIA
- CONEXION DE 1/2
- REGULADOR DE PRESIÓN DE 3 BAR
- EFECTO PIEDRA



ARKEMA
DESIGN
MADE IN ITALY



**ACCESSORI &
COMPLEMENTI**

**ACCESSORIES &
COMPLEMENTS**



PIASTRELLA IN NOBILITATO D180

PIASTRELLA IN NOBILITATO PER L'INSTALLAZIONE DOCCIA

MELAMINE TILES FOR SHOWER INSTALLATION

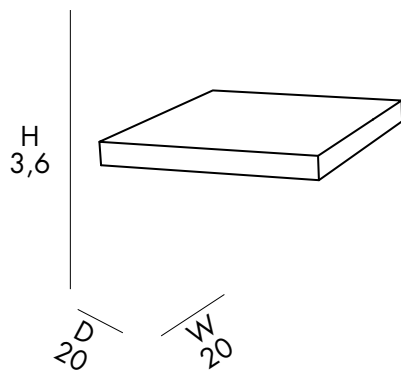

5 Kg

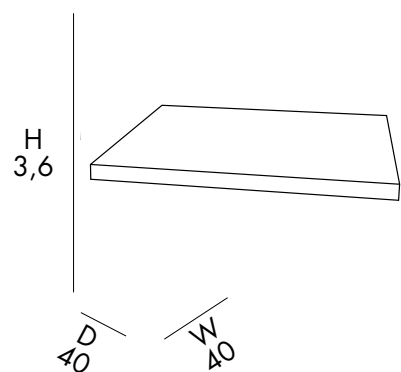

D 20 cm
H 4 cm
W 20 cm

D 40 cm
H 3,6 cm
W 40 cm

PIASTRELLE IN NOBILITATO per docce e fontane

- 20 x 20 cm (Cod. D180/20)
- 40 x 40 cm (Cod. D180/40)
- IGNIFUGA

MELAMINE TILES for shower and fountain

- 20 x 20 cm (Cod. D180/20)
- 40 x 40 cm (Cod. D180/40)
- FIREPROOF

CARREAUX DE MÉLAMINE pour douches et fontaines

- 20 x 20 cm (Cod. D180/20)
- 40 x 40 cm (Cod. D180/40)
- IGNIFUGE

AZULEJOS DE MELAMINA para duchas y fuentes

- 20 x 20 cm (Cod. D180/20)
- 40 x 40 cm (Cod. D180/40)
- IGNIFUGO

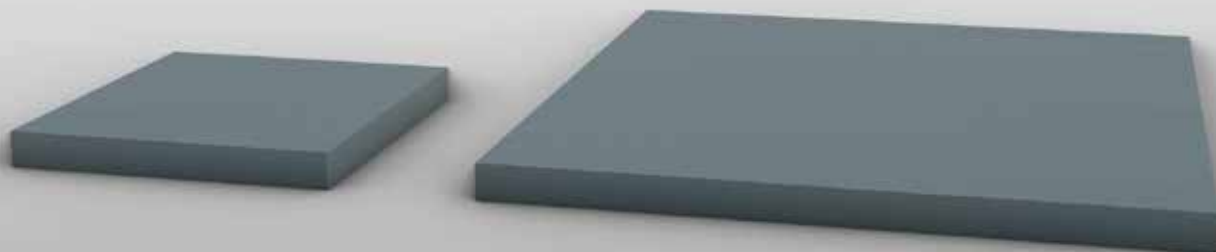

FISSAGGIO A VITE D125

FISSAGGIO A VITE STUDIATO PER TERRENI MORBIDI UTILIZZABILE SU TUTTI I MODELLI DI DOCCE CON PIASTRELLA IN NOBILITATO
SCREW FIXING DESIGNED FOR SOFT GROUNDS CAN BE USED ON ALL SHOWER MODELS WITH MELAMINE-COATED TILE

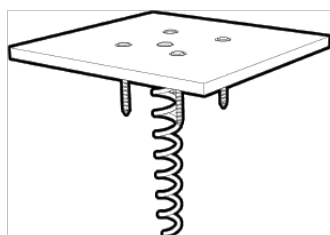
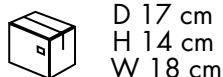
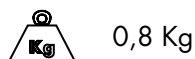
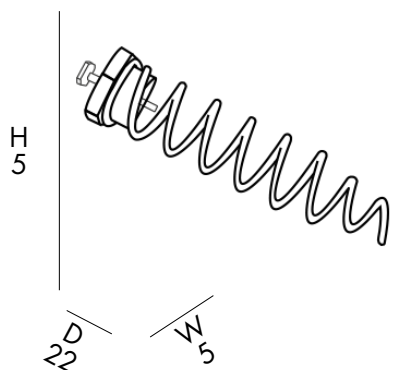

LAMINATED TILE
(not included)

SISTEMA DI FISSAGGIO A VITE

- STUDIATO PER TERRENI MORBIDI UTILIZZABILI SU TUTTI I MODELLI DI DOCCIA
- FISSAGGIO SU PANNELLO FENOLICO O PIASTRELLA
- REALIZZATO IN ACCIAIO

SCREW BASED FASTENING SYSTEM

- DESIGNED FOR SOFT SOILS THAT CAN BE USED ON ALL SHOWER MODELS
- FIXING ON PHENOLIC PANEL OR TILE
- MADE OF STEEL

SYSTÈME DE FIXAGE A VIS

- CONÇU POUR LES SOLS MOUS QUI PEUVENT ÊTRE UTILISÉS SUR TOUS MODÈLES DE DOUCHE
- FIXATION SUR PANNEAU PHÉNOLIQUE OU CARREAU FAIT D'ACIER

SISTEMA DE FIJACION CON TORNILLO

- DISEÑADO PARA SUELOS BLANDOS QUE SE PUEDEN UTILIZAR EN TODOS MODELOS DE DUCHA
- FIJACIÓN SOBRE PANEL O TEJA FENÓLICA
- HECHO DE ACERO

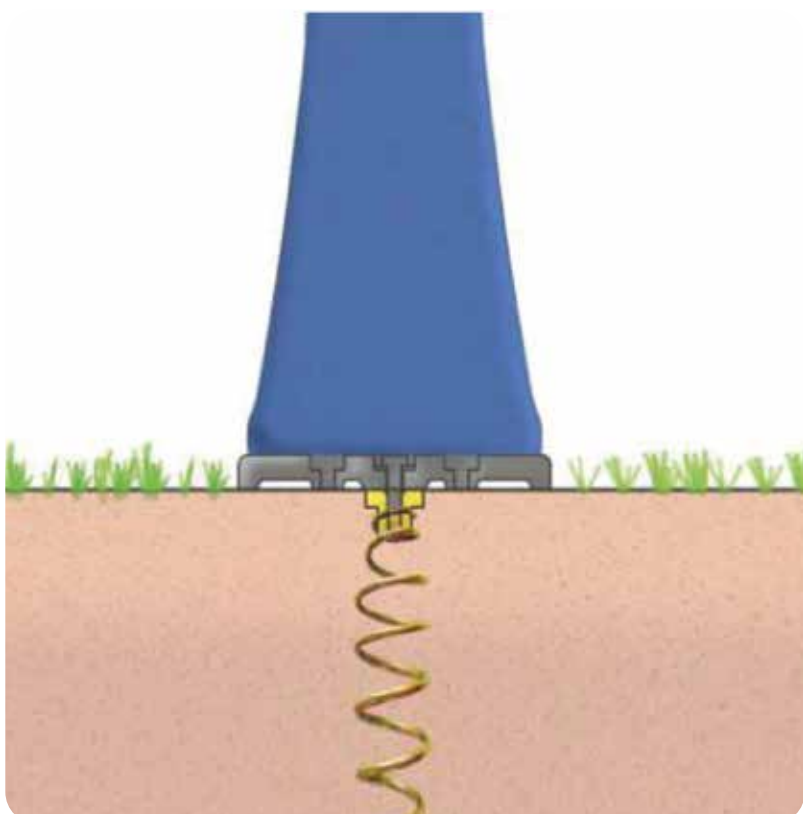

STAFFA DI FISSAGGIO D120

STAFFA ANTI VANDALICA E ANTI FURTO ANTI THEFT CLAMPING SYSTEM

Compatibile con / Compatible with:
F500 - F520 - F600 - F620 - F620/90

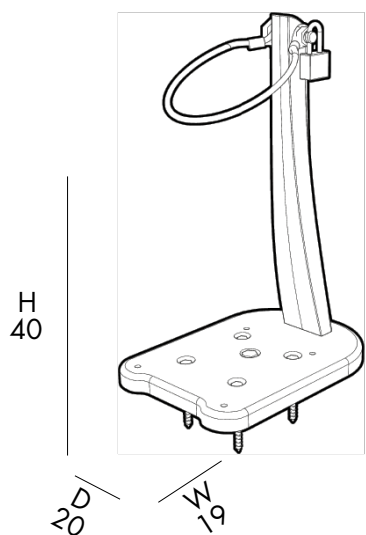

3,8 Kg



D 20 cm
H 41 cm
W 21 cm

STAFFA ANTI VANDALICA e antifurto

- REALIZZATA IN ALLUMINIO

CLAMPING SYSTEM and anti-theft

- MADE OF ALUMINIUM

SUPPORT ANTIVANDAL et anti vol

- FABRIQUÉ EN ALUMINIUM

SOPORTE ANTIVANDÁLICO y antirrobo

- REALIZADO DE ALUMINIUM



KIT FILTRO ANTICALCARE D150

KIT FILTRO ANTICALCARE CALDAMENTE CONSIGLIATO PER MODELLI DI DOCCE IN ALLUMINIO, ADATTABILE ANCHE SUI MODELLI IN RESINA
LIMESCALE FILTER KIT HIGHLY RECOMMENDED FOR SHOWER MODELS IN ALUMINUM, ALSO ADAPTABLE TO RESIN MODELS

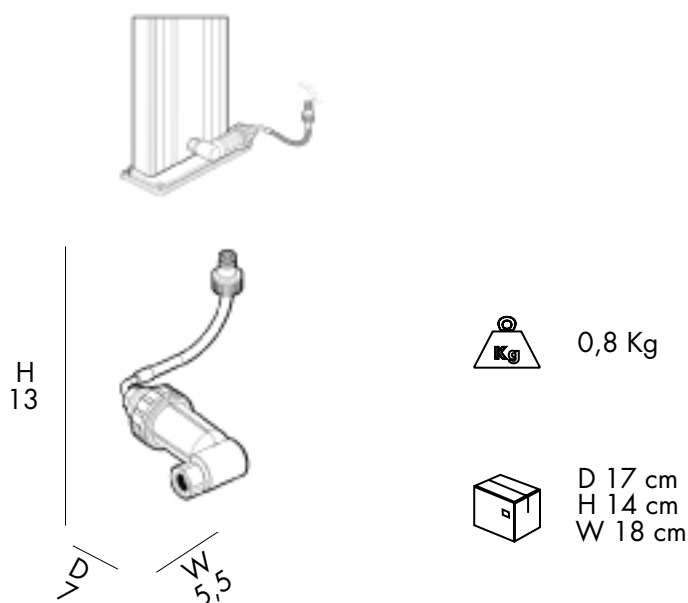

KIT FILTRO ANTICALCARE

- PER MODELLI IN ALLUMINIO COMPLETO DI RACCORDERIA E FLESSIBILE
- IL SALE DI RICAMBIO È ACQUISTARE IN UN PUNTO VENDITA SPECIFICO (FERRAMENTA - NEGOZI PISCINE - AMAZON)

ANTI LIMESCALE FILTER

- FOR ALUMINUM MODELS COMPLETE WITH FITTINGS AND FLEXIBLE HOSE
- REPLACEMENT SALT MUST BE PURCHASED IN A SPECIFIC POINT OF SALE (HARDWARE STORE - POOL SHOPS - AMAZON)

FILTRE ANTICALCAIRE

- POUR LES MODÈLES EN ALUMINIUM COMPLETS DE RACCORDS ET TUBE FLEXIBLE
- LE SEL DE REMPLACEMENT DOIT ÊTRE ACHETÉ DANS UN POINT DE VENTE SPÉCIFIQUE (MAGASIN DE QUINCAILLERIE - MAGASINS DE PISCINE - AMAZON)

KIT FILTRO ANTICAL

- PARA MODELOS DE ALUMINIO COMPLETOS CON ACCESORIOS Y FLEXIBLES
- LA SAL DE RECAMBIO SE DEBE COMPRAR EN UN PUNTO DE VENTA ESPECÍFICO (FERRETERÍA - TIENDAS DE PISCINA - AMAZON)



SACCO FODERA D170

COMPATIBILE CON TUTTI I NOSTRI MODELLI DI DOCCE E FONTANE

COMPATIBLE WITH ALL OUR MODELS OF SHOWERS AND FOUNTAINS

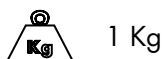
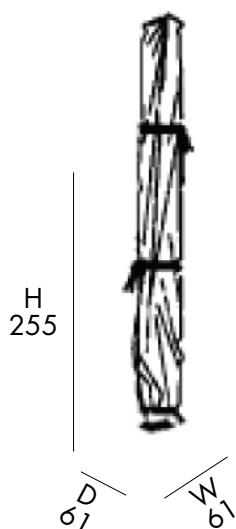

PACKAGING - 1Kg

SACCO FODERA PER DOCCE

- SACCO FODERA IN PVC 100% PLASTIFICATO NYLON, IMPERMEABILE ALL'ACQUA, COMPOSTO DA TRE LACCETTI
- UNIVERSALE PER TUTTI I MODELLI
- SOLO NELLA VERSIONE NERA

COVER BAG FOR SHOWERS

- BAG MADE IN PVC 100% PLASTIFIED NYLON, WATERPROOF, COMPOSED OF THREE STRAPS
- UNIVERSAL FOR ALL MODELS
- ONLY IN THE BLACK VERSION

HOUSSE PUR DOUCHES

- DOUBLURE DU SAC EN PVC 100% NYLON PLASTIFIE, IMPERMÉABLE, COMPOSÉ DE TROIS SANGLES
- UNIVERSEL POUR TOUTS LES MODÈLES
- UNIQUEMENT DANS LA VERSION NOIRE

BOLSA PARA DUCHAS

- BOLSA EN PVC 100% NYLON PLASTIFICADO, IMPERMEABLE, COMPUESTO POR TRES CORREAS
- UNIVERSAL PARA TODOS LOS MODELOS
- SÓLO EN LA VERSIÓN NEGRA



COLORS

STANDARD COLORS RESIN

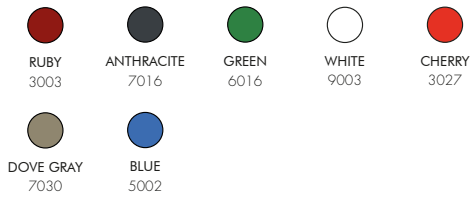

SPECIAL COLORS RESIN



*EXTRA FOR SPECIAL COLORS



CESTELLO D200

CESTELLO

- PER H2O, GH115, Q695
- SCARICO D'ACQUA POSIZIONATO SOTTO IL CESTELLO

BASKET

- FOR H2O, GH115, Q695
- WATER DRAIN PLACED UNDER THE BASKET

SEAU

- POUR H2O, GH115, Q695
- VIDANGE D'EAU PLACÉE SOUS LE SEAU

CESTA

- PARA H2O, GH115, Q695
- DRENAJE DE AGUA COLOCADO BAJO LA CESTA

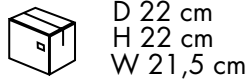
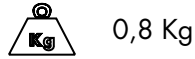
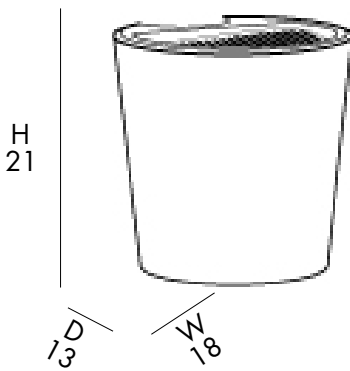



SERENDIPITY



COLORS

STANDARD COLORS RESIN

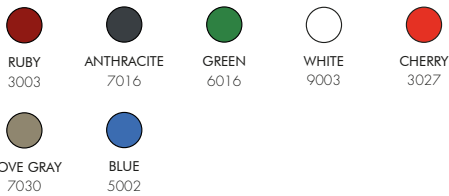

SPECIAL COLORS RESIN



*EXTRA FOR SPECIAL COLORS



SERENDIPITY CHAISE S010

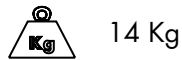
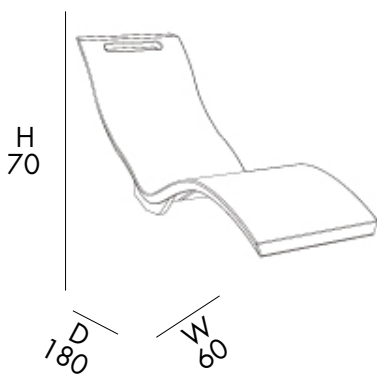

14 Kg

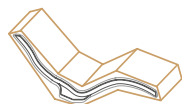

PACKAGING - 1Kg



CHAISE LONGUE SERENDIPITY

- SEDUTA
- REALIZZATA IN POLIETILENE COLORATO IN MASSA
- CONFIGURABILE CON GLI ACCESSORI: S910 - S930 - S960
- N.B. UTILIZZABILE ANCHE SENZA NESSUN SUPPORTO



CHAISE LONGUE SERENDIPITY

- SEAT
- MADE OF MASS COLORED HD POLYETHYLENE
- CONFIGURABLE WITH ACCESSORIES: S910 - S930 - S960
- N.B. ALSO USABLE WITHOUT ANY SUPPORT

CHAISE LONGUE SERENDIPITY

- CHAISE
- FABRIQUÉE EN POLYÉTHYLÈNE COLORATION MASSIVE
- CONFIGURABLE AVEC ACCESSOIRES: S910 - S930 - S960
- N.B. UTILISABLE AUSSI SANS AUCUN SUPPORT



CHAISE LONGUE SERENDIPITY

- ASIENTO
- REALIZADA EN POLIETILENO COLOREADO A GRANEL
- CONFIGURABLE CON ACCESORIOS: S910 - S930 - S960 N.B. UTILIZABLE TAMBIÉN SIN NINGÚN SOPORTE

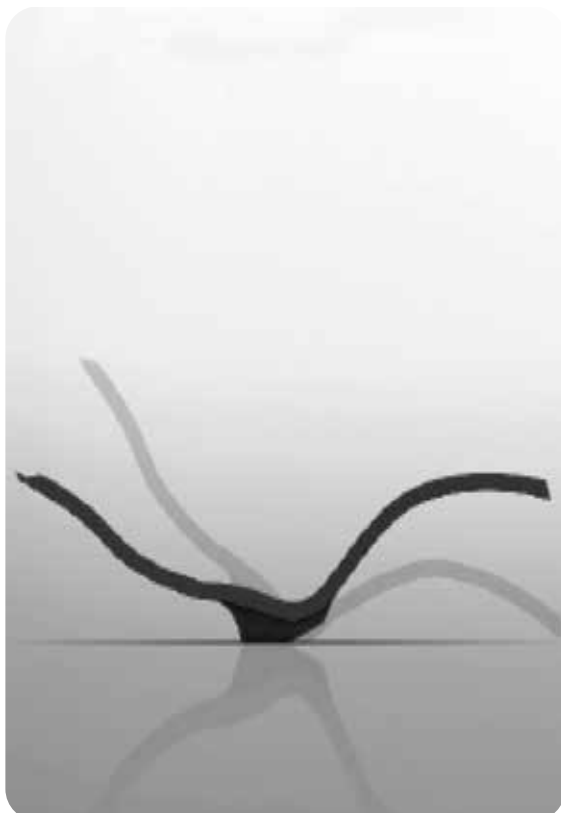

COLORS

STANDARD COLORS RESIN

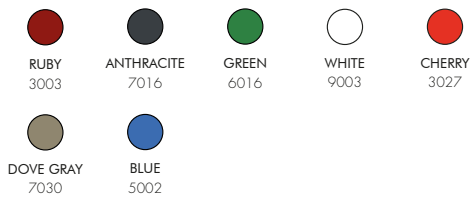

SPECIAL COLORS RESIN



*EXTRA FOR SPECIAL COLORS



SERENDIPITY CHAISE HEATED S010/80

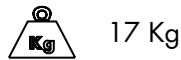
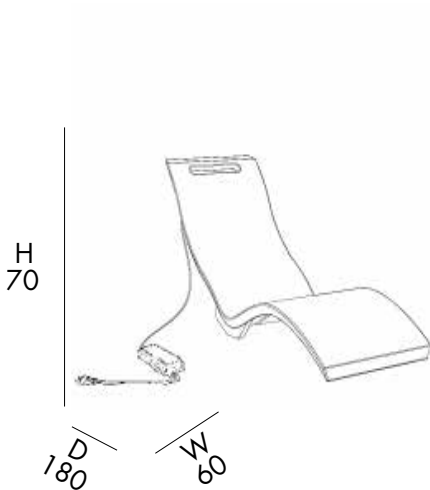

PACKAGING - 1Kg



CHAISE LONGUE SERENDIPITY HYBRIDA

- SEDUTA
- REALIZZATA IN POLIETILENE COLORATO IN MASSA
- CONFIGURABILE CON GLI ACCESSORI: S910
- TRASFORMATORE VOLT 220/110 A 24
- TEMPERATURA MASSIMA 40°

CHAISE LONGUE SERENDIPITY HYBRIDA

- SEAT
- MADE OF MASS COLORED HD POLYETHYLENE
- CONFIGURABLE WITH ACCESSORIES: S910
- TRANSFORMER VOLT 220/110 A 24
- MAXIMUM TEMPERATURE 40°

CHAISE LONGUE SERENDIPITY HYBRIDA

- CHAISE
- FABRIQUÉE EN POLYÉTHYLÈNE COLORATION MASSIVE
- CONFIGURABLE AVEC ACCESSOIRES: S910
- TRANSFORMATEUR VOLT 220/110 A 24
- TEMPÉRATURE MAXIMALE DE 40°

CHAISE LONGUE SERENDIPITY HYBRIDA

- ASIENTO
- REALIZADA EN POLIETILENO COLOREADO A GRANEL
- CONFIGURABLE CON ACCESORIOS: S910
- TRANSFORMADOR VOLT 220/110 A 24
- TEMPERATURA MÁXIMA 40°



COLORS

STANDARD COLORS RESIN

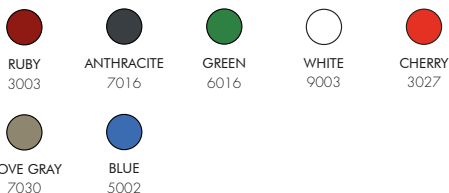

SPECIAL COLORS RESIN



*EXTRA FOR SPECIAL COLORS



SERENDIPITY CHAISE OUTDOOR S110

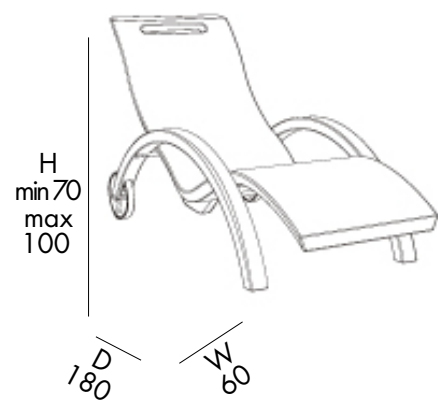

22 Kg



D 180 cm
H 100 cm
W 60 cm



D 126 cm
H 48 cm
W 16 cm

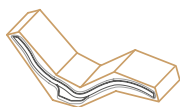

PACKAGING - 1Kg

CHAISE LONGUE SERENDIPITY

- SEDUTA
- REALIZZATA IN POLIETILENE COLORATO IN MASSA
- SUPPORTO IN ALLUMINIO
- LE IL SUPPORTO ESTERNO E LE RUOTE SONO IMBALLATE DA SOLE



CHAISE LONGUE SERENDIPITY

- SEAT
- MADE OF MASS COLORED HD POLYETHYLENE
- BRASS WITH WHEELS
- THE OUTER SUPPORT AND WHEELS ARE PACKED ON THEIR OWN

CHAISE LONGUE SERENDIPITY

- CHAISE
- FABRIQUÉE EN POLYÉTHYLÈNE COLORATION MASSIVE
- BRAS AVEC ROUELLES
- LE SUPPORT EXTÉRIEUR ET LES ROUES SONT EMBALLÉS SÉPARÉMENT



CHAISE LONGUE SERENDIPITY

- ASIENTO
- REALIZADA EN POLIETILENO COLOREADO A GRANEL
- BRAZOS CON RUEDAS
- EL SOPORTE EXTERIOR Y LAS RUEDAS SE EMBALAN SOLOS

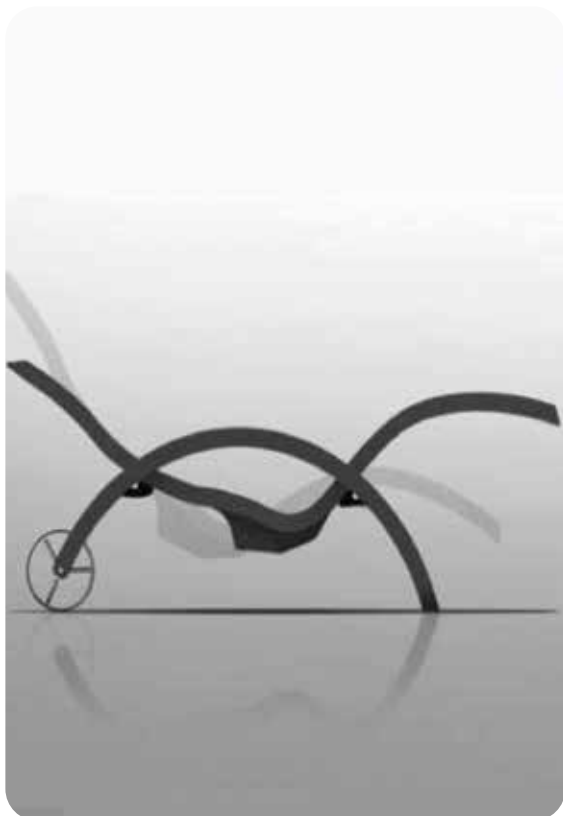

COLORS

STANDARD COLORS RESIN

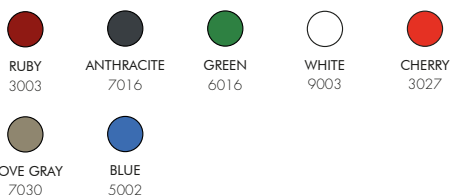

SPECIAL COLORS RESIN



*EXTRA FOR SPECIAL COLORS



SERENDIPITY CHAISE FLOATING S130

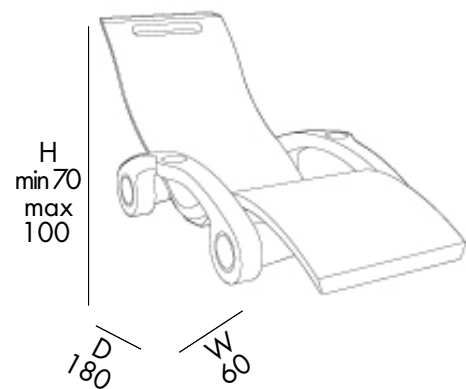

24 Kg



D 180 cm
H 100 cm
W 60 cm



D 103 cm
H 25 cm
W 48 cm

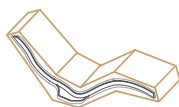

PACKAGING - 1Kg

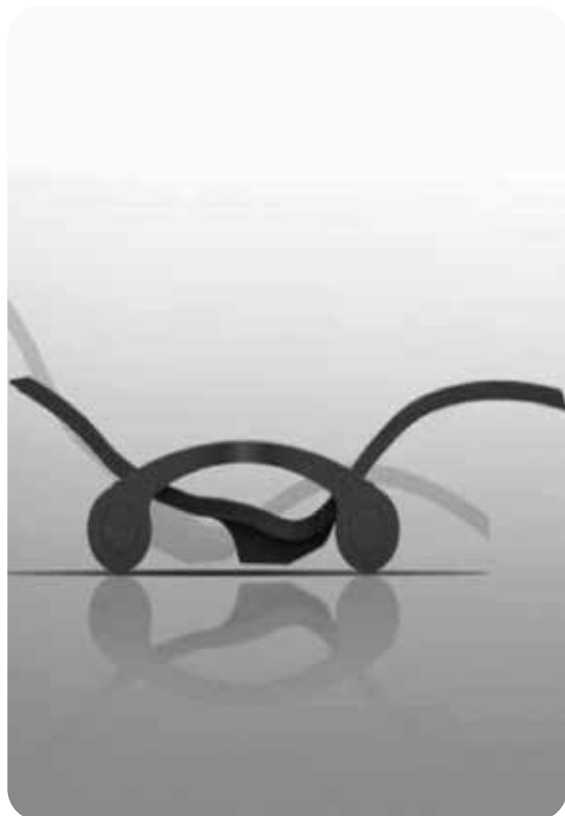

CHAISE LONGUE SERENDIPITY

- SEDUTA
- REALIZZATA IN POLIETILENE COLORATO IN MASSA
- SUPPORTO GALLEGGIANTE
- IL SUPPORTO GALLEGGIANTE È IMBALLATA DA SOLO



CHAISE LONGUE SERENDIPITY

- SEAT
- MADE OF MASS COLORED HD POLYETHYLENE
- FLOATING SUPPORT
- THE FLOATING SUPPORT IS PACKED BY ITSELF



CHAISE LONGUE SERENDIPITY

- CHAISE
- FABRIQUÉE EN POLYÉTHYLÈNE COLORATION MASSIVE
- SUPPORT FLOTTANT
- LE SUPPORT FLOTTANT EST EMBALLÉ SEUL



CHAISE LONGUE SERENDIPITY

- ASIENTO
- REALIZADA EN POLIETILENO COLOREADO A GRANEL
- SOPORTE FLOTANTE
- EL SOPORTE FLOTANTE SE EMBALA SOLO



COLORS

STANDARD COLORS RESIN

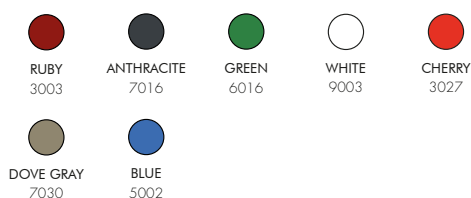

SPECIAL COLORS RESIN



*EXTRA FOR SPECIAL COLORS



SERENDIPITY CHAISE OUTDOOR

SUPPORT S910

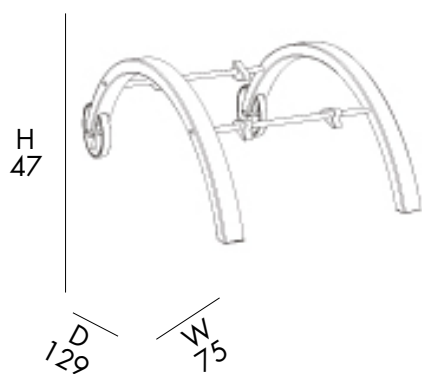

7 Kg



D 126 cm
H 48 cm
W 16 cm



SERENDIPITY SUPPORTO ESTERNO

- SUPPORTO ESTERNO
- SUPPORTO IN ALLUMINIO E GOMME ANTISCIVOLO
- REALIZZATA IN POLIETILENE COLORATA IN MASSA



SERENDIPITY OUTDOOR SUPPORT

- OUTDOOR SUPPORT
- WHEELS IN ALUMINIUM AND RUBBER ANTI GRIP
- MADE OF MASS COLORED HD POLYETHYLENE

SUPPORT EXTÉRIEUR SERENDIPITY

- SUPPORT EXTERIEUR
- ROUES EN ALUMINIUM ET GOMME ANTI-GRIP
- FABRIQUÉE EN POLYÉTHYLÈNE COLORATION MASSIVE



APOYO EXTERIOR SERENDIPITY

- APOYO EXTERIOR
- RUEDAS DE ALUMINIO Y GOMA ANTIPROPULSOR
- REALIZADA EN POLIETILENO COLOREADO A GRANEL



COLORS

STANDARD COLORS RESIN

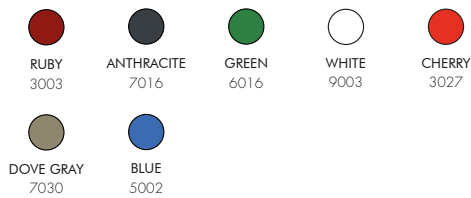

SPECIAL COLORS RESIN



*EXTRA FOR
SPECIAL COLORS



SERENDIPITY CHAISE FLOATING

SUPPORT S930

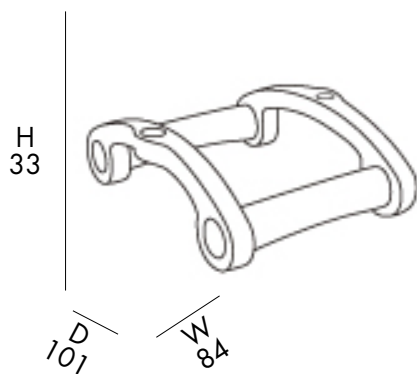

10 Kg



D 103 cm
H 25 cm
W 48 cm



SERENDIPITY SUPPORTO GALLEGGIANTE

- SUPPORTO ESTERNO
- SUPPORTO GALLEGGIANTE CON PORTA BICCHIERE
- REALIZZATA IN POLIETILENE COLORATA IN MASSA



SERENDIPITY FLOATING SUPPORT

- OUTDOOR SUPPORT
- FLOATING SUPPORT WITH CUP HOLDER
- MADE OF MASS COLORED HD POLYETHYLENE

SUPPORT FLOTTANT SERENDIPITY

- SUPPORT EXTERIEUR
- SUPPORT FLOTTANT AVEC PORTE GOBELET
- FABRIQUÉE EN POLYÉTHYLÈNE COLORATION MASSIVE



APOYO FLOTANTE SERENDIPITY

- APOYO EXTERIOR
- APOYO FLOTANTE CON PORTA VASOS
- REALIZADA EN POLIETILENO COLOREADO A GRANEL



UNDERWATER SUPPORT S960

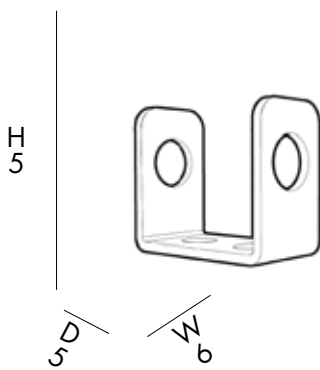
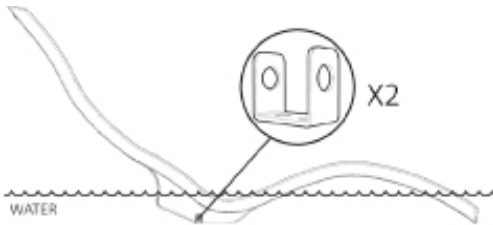

1 Kg



D 16 cm
H 11 cm
W 16 cm

STAFFA PER SERENDIPITY IMMERSA

- STAFFA PER ANCORAGGIO IN ACQUA
- REALIZZATA IN ALLUMINIO ANODIZZATO



SERENDIPITY UNDERWATER SUPPORT

- UNDERWATER SUPPORT
- MADE OF ANODIZED ALUMINUM

SUPPORT SERENDIPITY PLONGÉE

- SUPPORT POUR ANCRAGE DANS L'EAU
- EN ALUMINIUM ANODISÉ

APOYO SERENDIPITY IMMERSA

- SOPORTE PARA SERENDIPITY IMMERSA
- HECHO EN ALLUMINIO ANODIZATO

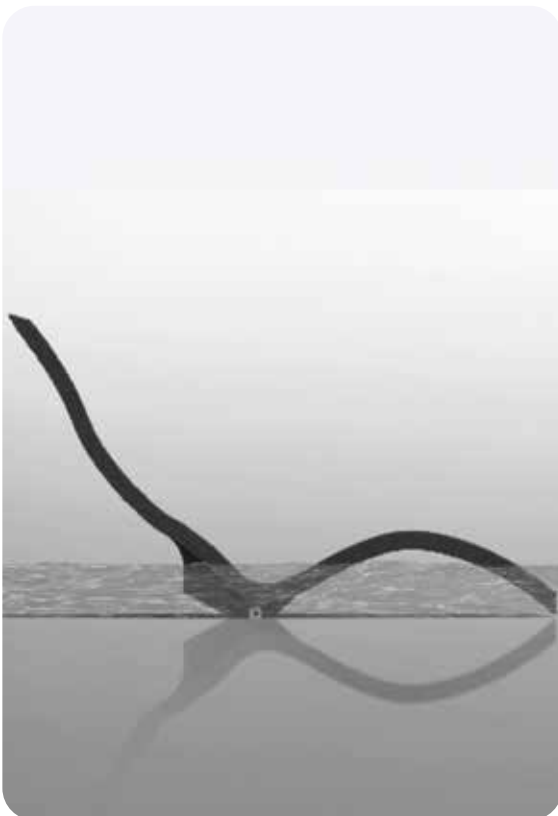

SERENDIPITY[®] CHAISE

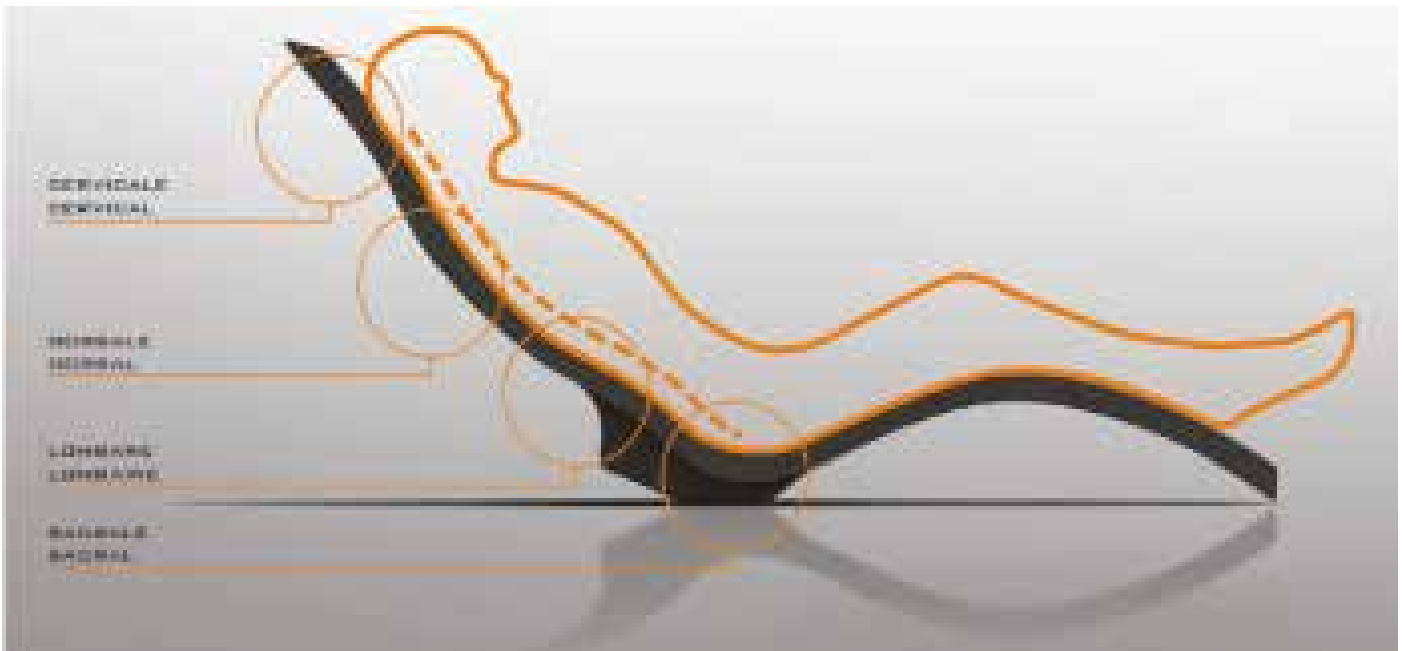

Chaise Longue in polietilene dalla superficie in effetto stone che le dà un valore aggiunto.

Le imperfezioni sono volute per conferire all' oggetto un effetto stone più naturale, con il vantaggio che utilizzandola non si ha l' effetto ventosa, grazie a una micro circolazione dell' aria data dall' effetto della superficie. La sua forma ergonomica e' perfetta per i momenti di relax. La scocca e' volutamente morbida e flessibile, per rendere confortevole il suo utilizzo anche senza l'uso di un telo.

Resistente agli UV – alla salsedine- all'umidità'.



Chaise Longue in polyethylene with a stone effect surface that gives it additional value.

The imperfections are made on purpose to give this object a more natural stone effect, with the advantage that there is no suction effect, thanks to a micro circulation of the air given by the surface effect. Its shape is ergonomic, and it is perfect for relaxing moments.

The body is on purpose soft and flexible, to make its use comfortable even without a towel.

Resistant to UV rays- salt- humidity.



Chaise Longue en polyéthylène avec sa surface en effet pierre qui lui donne une valeur additionnelle.

Les imperfections sont voulues pour conférer à cet objet un effet pierre plus naturel, avec l'avantage que en l' utilisant vous n'avez pas l'effet d'aspiration, grâce à une microcirculation de l'air donnée de l'effet de la surface.

Sa forme ergonomique est parfaite pour les moments de relax.

La surface est volontairement souple et flexible , pour rendre son usage très confortable, même sans utiliser une serviette.

Résistante aux rayons UV, à la salinité et à l'humidité.



Chaise Loque en polietileno de la superficie en efecto piedra que le aporta valor añadido.

Las imperfecciones son intencionales para otorgar all' objeto un efecto piedra más natural, con el ventaja que utilizando no se la tiene l' efecto ventosa, gracias a una micro circulación dell'aire hecha dall'efecto de la superficie.

Su forma ergonómica y' perfecta por los momentos de relajamiento.

El bastidor y' intencionalmente blanda y flexible, para hacer confortable su empleo también sin el empleo de un paño.

Resistente a los rayos UV , a la salinidad - a la humedad'.



**COMPLEMENTI
D'ARREDO**

**COMPLEMENTS
FURNITURE**





LA NOSTRA GAMMA DI ARREDO

OUR RANGE OF FURNITURE

 Prodotti realizzati in polietilene, un materiale Atossico, Riciclabile al 100%, Resistente alle basse ed alte temperature (-60°/+80°), agli urti e ai raggi solari (UV). Le sue ottime proprietà isolanti, la sua versatilità e la sua stabilità chimica lo rendono ideale per la realizzazione di prodotti sia da esterno che da interno. Facili da pulire e semplici da movimentare grazie al loro peso ridotto, sono molto funzionali oltre che esteticamente ricercati.

 Products made of polyethylene, a non-toxic 100% recyclable material, resistant to low and high temperatures (-60°/+80°), and the impact and sunlight (UV). Its excellent insulating properties, its versatility and chemical stability make it ideal for both outdoor and indoor use. Easy to clean and simple to handle thanks to the low weight, is highly functional as well as aesthetically pleasing.

 Produits en polyéthylène, un matériel non toxique, 100 % recyclable, résistant aux basses et hautes températures (-60°/+80°), aux chocs et à la lumière du soleil (UV). Ses excellentes propriétés isolantes, sa polyvalence et sa stabilité chimique font un matériau idéal pour la fabrication de produits d'intérieur et d'extérieur. Faciles à nettoyer et à manipuler grâce à leur poids, réduit ils sont très fonctionnels et esthétiques.

 Productos fabricados con polietileno, un material no tóxico y 100% reciclable, resistente a las bajas y altas temperaturas (-60°/+80°), a los impactos y a la luz solar (UV). Sus excelentes propiedades aislantes, su versatilidad y su estabilidad química lo hacen ideal para fabricar productos tanto de exterior como de interior. Fáciles de limpiar y de manipular gracias a su reducido peso, son muy funcionales además de estéticamente agradables.



MATERIALE ATOSSICO / NON-TOXIC MATERIAL

Polietilene - Polyethylene



100% RICICLABILE / 100% RECYCLABLE

Per una vera sostenibilità - For true sustainability



-60° +80°

Resistenza ad alte e basse temperature -
Resistance to high and low temperatures



RESISTENTE AGLI URTI / IMPACT-RESISTANT

Facilità di modellazione e buona resistenza -
Ease of shaping and good resistance



RESISTENTE AI RAGGI UV / UV-RESISTANT

Resistenza all'invecchiamento - Resistance to ageing



POSSIBILITÀ DI PERSONALIZZAZIONE - PERSONALISATION POSSIBILITY



FACILE DA TRASPORTARE EASY TO TRANSPORT



IDROREPELENTE - WATERPROOF



FACILE DA PULIRE - EASY TO CLEAN

LA NOSTRA GAMMA DI ARREDO

OUR RANGE OF FURNITURE

 I nostri prodotti possono essere personalizzati con l'inserimento di un LOGO (1) o qualsiasi ALTRA DICITURA (2) e/o realizzati in qualsiasi COLORE (3) a scelta in massa.

La personalizzazione (1 e 2) avviene con delle etichette che vengono applicate al prodotto durante la produzione, in modo da essere inglobate direttamente nel prodotto stesso, personalizzandolo in maniera permanente. Questo tipo di personalizzazione (1 e 2) è resistente a pioggia, neve, agenti chimici, solventi, acqua salata, vapore, lavaggio ad alta pressione o raggi UV. Se invece il prodotto è laccato la personalizzazione (1 e 2) può avvenire anche attraverso la verniciatura. Tutte le personalizzazioni (1, 2 e 3) sono disponibili esclusivamente su richiesta specifica e con ordinativo di quantità minima.

 Our products can be customised with the insertion of a LOGO (1) or any OTHER LABEL (2) and/or produced in any COLOUR (3) of your choice in bulk.

Customisation (1 and 2) is carried out with labels that are applied to the product during production, so that they are incorporated directly into the product itself, customising it permanently. This type of personalisation (1 and 2) is resistant to rain, snow, chemicals, solvents, salt water, steam, high-pressure washing or UV radiation. If, on the other hand, the product is lacquered, customisation (1 and 2) can also be carried out by painting. All customisations (1, 2 and 3) are only available on specific request and with a minimum order quantity.

 Nos produits peuvent être personnalisés par l'insertion d'un LOGO (1) ou de toute AUTRE ÉTIQUETTE (2) et/ou produits en vrac dans la COULEUR (3) de votre choix.

La personnalisation (1 et 2) est réalisée à l'aide d'étiquettes qui sont appliquées sur le produit pendant la production, de sorte qu'elles sont incorporées directement dans le produit lui-même, le personnalisant de façon permanente. Ce type de personnalisation (1 et 2) résiste à la pluie, à la neige, aux produits chimiques, aux solvants, à l'eau salée, à la vapeur, au lavage à haute pression ou aux rayons UV. Si, en revanche, le produit est laqué, la personnalisation (1 et 2) peut également être réalisée par peinture. Toutes les personnalisations (1, 2 et 3) ne sont disponibles que sur demande spécifique et avec une quantité de commande minimale.

 Nuestros productos pueden personalizarse con la inserción de un LOGOTIPO (1) o cualquier OTRA ETIQUETA (2) y/o producirse en cualquier COLOR (3) de su elección a granel.

La personalización (1 y 2) se realiza con etiquetas que se aplican al producto durante la producción, de modo que se incorporan directamente al propio producto, personalizándolo de forma permanente. Este tipo de personalización (1 y 2) es resistente a la lluvia, la nieve, los productos químicos, los disolventes, el agua salada, el vapor, los lavados a alta presión o la radiación UV. Si, por el contrario, el producto está lacado, la personalización (1 y 2) también puede realizarse mediante pintura. Todas las personalizaciones (1, 2 y 3) sólo están disponibles bajo pedido específico y con una cantidad mínima de pedido.





SOLAR LIGHT



COLOR LIGHT RESIN



NEUTRAL

SFERA FOTOVOLTAICA SF300

SF300

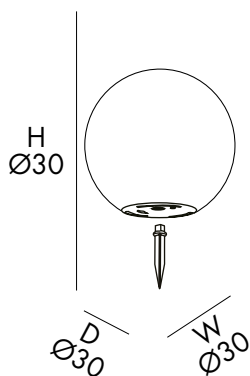

2 Kg



D 32 cm
H 29 cm
W 31 cm



SFERA LUMINOSA

- VERSIONE LUMINOSA FOTOVOLTAICA
- REALIZZATA IN POLIETILENE IN MASSA
- GALLEGGIANTE
- LED RGB
- DOTATA DI PALETTO PER FISSAGGIO A TERRA
- TELECOMANDO



LUMINOUS SPHERE

- PHOTOVOLTAIC LIGHT VERSION
- MADE IN HD MASS POLYETHYLENE
- FLOATING
- LED RGB
- EQUIPPED WITH PIN FOR GROUND FIXING
- REMOTE CONTROL

SPHERE LUMINEUSE

- VERSION LUMINEUSE PHOTOVOLTAÏQUE
- FABRIQUÉE EN POLYÉTHYLÈNE MASSIVE
- FLOTTANTE
- LED RGB
- ÉQUIPÉE D'UNE PELLE POUR LA FIXATION AU SOL
- TELECOMMANDE



ESFERA LUMINOSA

- VERSIÓN LUMINOSA FOTOVOLTAICA
- REALIZADA EN POLIETILENO A GRANEL
- FLOTANTE
- LED RGB
- EQUIPADO CON PALA PARA FIJACIÓN AL SUELO
- MANDO A DISTANCIA



COLOR LIGHT RESIN



NEUTRAL

SFERA FOTOVOLTAICA SF400

SF400

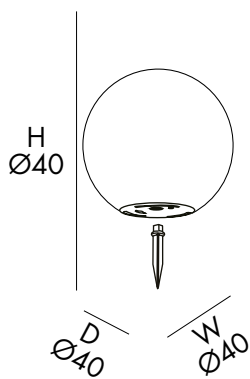

3 Kg



D 42 cm
H 40 cm
W 41 cm



SFERA LUMINOSA

- VERSIONE LUMINOSA FOTOVOLTAICA
- REALIZZATA IN POLIETILENE IN MASSA
- GALLEGGIANTE
- LED RGB
- DOTATA DI PALETTO PER FISSAGGIO A TERRA
- TELECOMANDO

🇬🇧 LUMINOUS SPHERE

- PHOTOVOLTAIC LIGHT VERSION
- MADE IN HD MASS POLYETHYLENE
- FLOATING
- LED RGB
- EQUIPPED WITH PIN FOR GROUND FIXING
- REMOTE CONTROL

SPHERE LUMINEUSE

- VERSION LUMINEUSE PHOTOVOLTAÏQUE
- FABRIQUÉE EN POLYÉTHYLÈNE MASSIVE
- FLOTTANTE
- LED RGB
- ÉQUIPÉE D'UNE PELLE POUR LA FIXATION AU SOL
- TELECOMMANDE

🇪🇸 ESFERA LUMINOSA

- VERSIÓN LUMINOSA FOTOVOLTAICA
- REALIZADA EN POLIETILENO A GRANEL
- FLOTANTE
- LED RGB
- EQUIPADO CON PALA PARA FIJACIÓN AL SUELO
- MANDO A DISTANCIA



COLOR LIGHT RESIN



NEUTRAL

SFERA FOTOVOLTAICA SF500

SF500

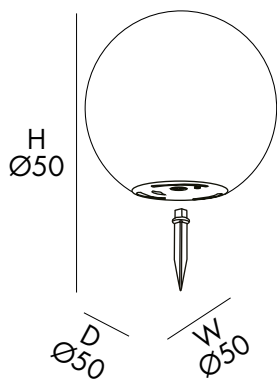

4 Kg



D 52 cm
H 50 cm
W 51 cm



recycled or
recyclable

SFERA LUMINOSA

- VERSIONE LUMINOSA FOTOVOLTAICA
- REALIZZATA IN POLIETILENE IN MASSA
- GALLEGGIANTE
- LED RGB
- DOTATA DI PALETTO PER FISSAGGIO A TERRA
- TELECOMANDO



LUMINOUS SPHERE

- PHOTOVOLTAIC LIGHT VERSION
- MADE IN HD MASS POLYETHYLENE
- FLOATING
- LED RGB
- EQUIPPED WITH PIN FOR GROUND FIXING
- REMOTE CONTROL

SPHERE LUMINEUSE

- VERSION LUMINEUSE PHOTOVOLTAÏQUE
- FABRIQUÉE EN POLYÉTHYLÈNE MASSIVE
- FLOTTANTE
- LED RGB
- ÉQUIPÉE D'UNE PELLE POUR LA FIXATION AU SOL
- TELECOMMANDE



ESFERA LUMINOSA

- VERSIÓN LUMINOSA FOTOVOLTAICA
- REALIZADA EN POLIETILENO A GRANEL
- FLOTANTE
- LED RGB
- EQUIPADO CON PALA PARA FIJACIÓN AL SUELO
- MANDO A DISTANCIA



COLOR LIGHT RESIN



NEUTRAL

LIGHT STONE S

DP8093/SOLARE

COMPLEMENTO D'ARREDO LUMINOSO

- VERSIONE LUMINOSA FOTOVOLTAICA
- REALIZZATA IN POLIETILENE IN MASSA
- LED RGB
- TELECOMANDO

BRIGHT FURNITURE COMPLEMENT

- PHOTOVOLTAIC LIGHT VERSION
- MADE IN HD MASS POLYETHYLENE
- LED RGB
- REMOTE CONTROL

ACCESSOIRE D'AMEUBLEMENT

- VERSION LUMINEUSE PHOTOVOLTAÏQUE
- FABRIQUÉE EN POLYÉTHYLÈNE MASSIVE
- LED RGB
- TELECOMMANDE

ACCESORIO DE MOBILIARIO LUMINOSOS

- VERSIÓN LUMINOSA FOTOVOLTAICA
- REALIZADA EN POLIETILENO A GRANEL
- LED RGB
- MANDO A DISTANCIA

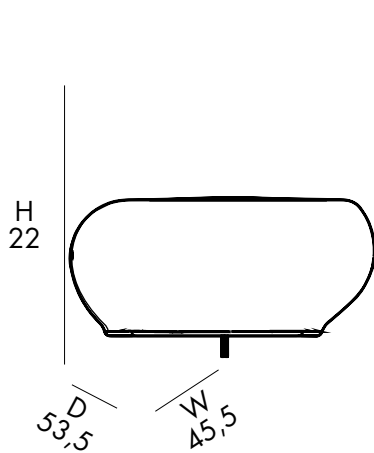

1,5 Kg



D - cm
H - cm
W - cm

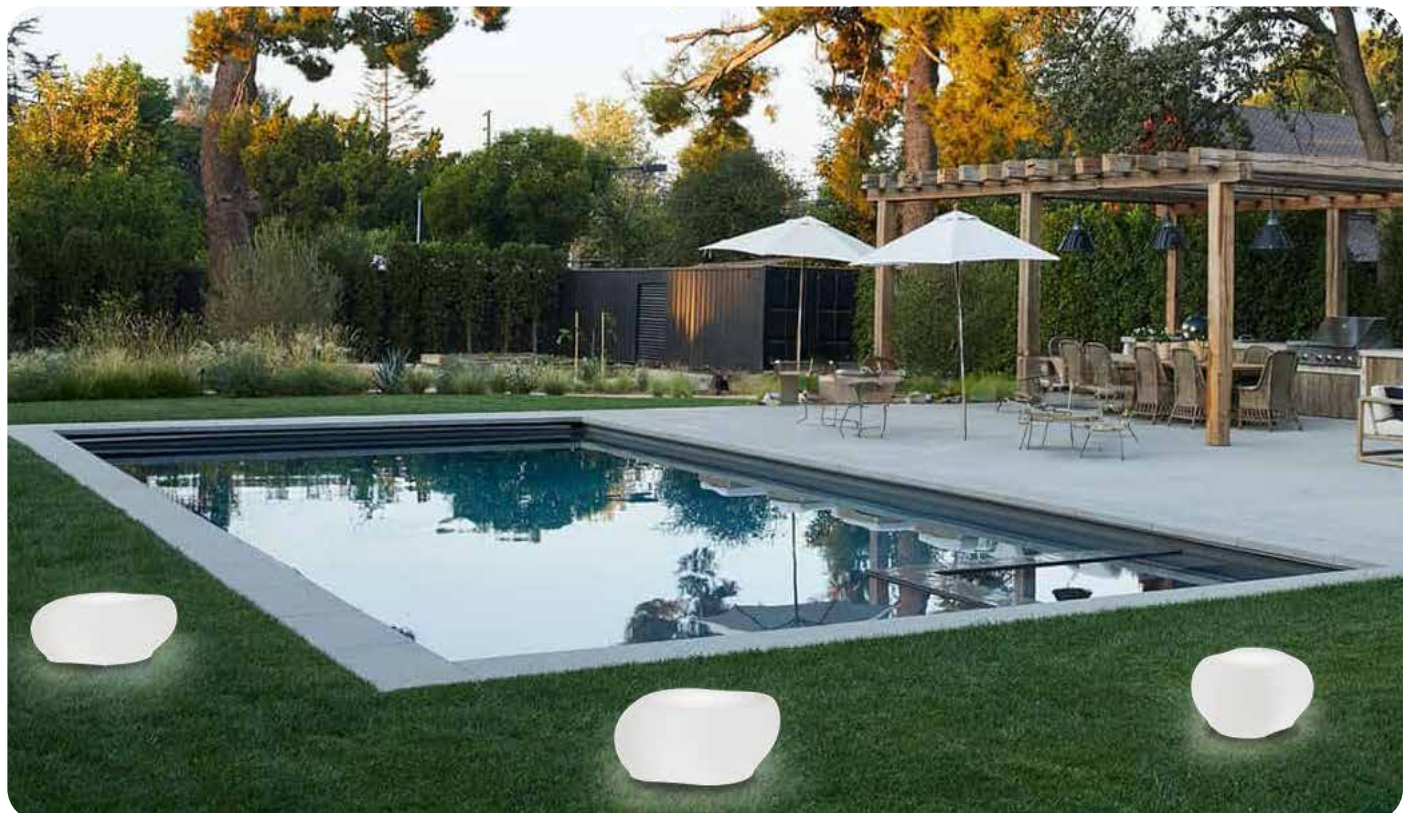

COLOR LIGHT RESIN



NEUTRAL

LIGHT STONE M

DP8094/SOLARE

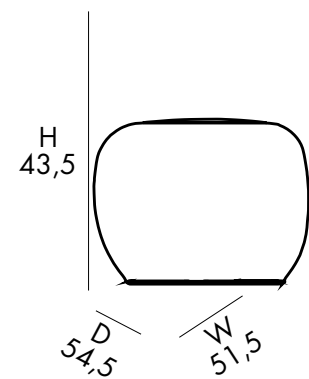

2 Kg



D - cm
H - cm
W - cm



COMPLEMENTO D'ARREDO LUMINOSO

- VERSIONE LUMINOSA FOTOVOLTAICA
- REALIZZATA IN POLIETILENE IN MASSA
- LED RGB
- TELECOMANDO



BRIGHT FURNITURE COMPLEMENT

- PHOTOVOLTAIC LIGHT VERSION
- MADE IN HD MASS POLYETHYLENE
- LED RGB
- REMOTE CONTROL

ACCESSOIRE D'AMEUBLEMENT

- VERSION LUMINEUSE PHOTOVOLTAÏQUE
- FABRIQUÉE EN POLYÉTHYLÈNE MASSIVE
- LED RGB
- TELECOMMANDE



ACCESORIO DE MOBILIARIO LUMINOSOS

- VERSIÓN LUMINOSA FOTOVOLTAICA
- REALIZADA EN POLIETILENO A GRANEL
- LED RGB
- MANDO A DISTANCIA



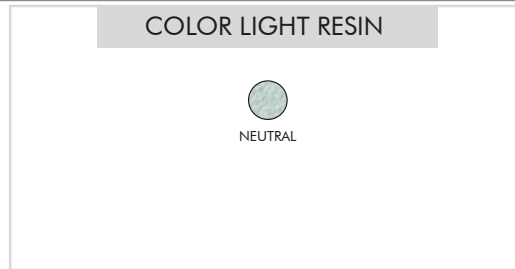

LIGHT STONE L

DP8095/SOLARE

COMPLEMENTO D'ARREDO LUMINOSO

- VERSIONE LUMINOSA FOTOVOLTAICA
- REALIZZATO IN POLIETILENE IN MASSA
- LED RGB
- TELECOMANDO

BRIGHT FURNITURE COMPLEMENT

- PHOTOVOLTAIC LIGHT VERSION
- MADE IN HD MASS POLYETHYLENE
- LED RGB
- REMOTE CONTROL

ACCESSOIRE D'AMEUBLEMENT

- VERSION LUMINEUSE PHOTOVOLTAÏQUE
- FABRIQUÉE EN POLYÉTHYLÈNE MASSIVE
- LED RGB
- TELECOMMANDE

ACCESORIO DE MOBILIARIO LUMINOSOS

- VERSIÓN LUMINOSA FOTOVOLTAICA
- REALIZADA EN POLIETILENO A GRANEL
- LED RGB
- MANDO A DISTANCIA

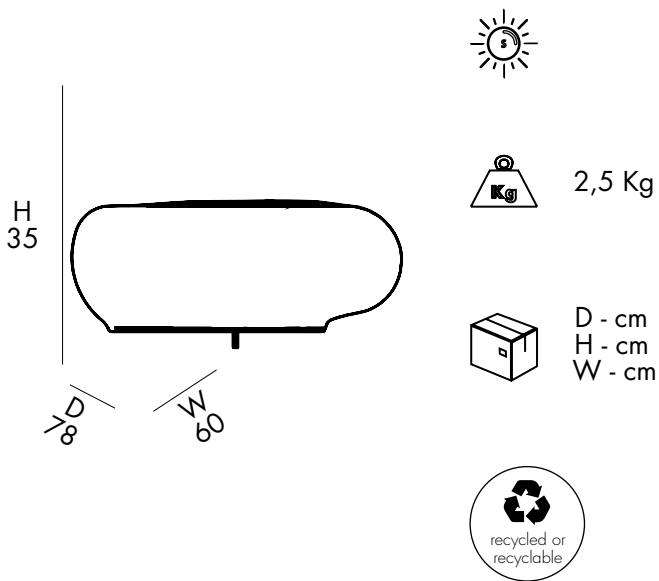

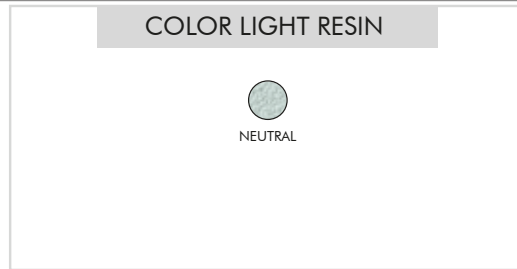

SOLAR BOA

SB100

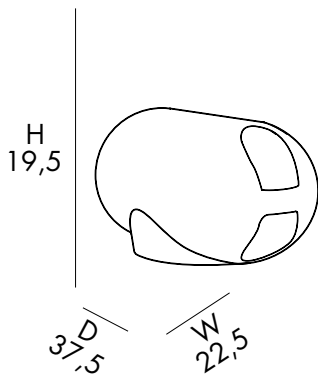

1 Kg



D 38 cm
H 20 cm
W 23 cm



BOA LUMINOSA

- VERSIONE LUMINOSA FOTOVOLTAICA
- REALIZZATA IN POLIETILENE IN MASSA
- GALLEGGIANTE
- LED RGB
- TELECOMANDO



LUMINOUS BOA

- PHOTOVOLTAIC LIGHT VERSION
- MADE IN HD MASS POLYETHYLENE
- FLOATING
- LED RGB
- REMOTE CONTROL

BOUÉE LUMINEUSE

- VERSION LUMINEUSE PHOTOVOLTAÏQUE
- FABRIQUÉE EN POLYÉTHYLÈNE MASSIVE
- FLOTTANTE
- LED RGB
- TELECOMMANDE



BOYA LUMINOSA

- VERSIÓN LUMINOSA FOTOVOLTAICA
- REALIZADA EN POLIETILENO A GRANEL
- FLOTANTE
- LED RGB
- MANDO A DISTANCIA



COLOR LIGHT RESIN



IRIS SL

DP1929/SOLARE

TAVOLINO/SEDUTA MODULARE

- VERSIONE LUMINOSA FOTOVOLTAICA
- REALIZZATA IN POLIETILENE IN MASSA
- LED RGB
- TELECOMANDO

TABLE/MODULAR SEAT

- PHOTOVOLTAIC LIGHT VERSION
- MADE IN HD MASS POLYETHYLENE
- LED RGB
- REMOTE CONTROL

TABLE/SIÈGE MODULAIRE

- VERSION LUMINEUSE PHOTOVOLTAÏQUE
- FABRIQUÉE EN POLYÉTHYLÈNE MASSIVE
- LED RGB
- TELECOMMANDE

MESA/ASIENTO MODULAR

- VERSIÓN LUMINOSA FOTOVOLTAICA
- REALIZADA EN POLIETILENO A GRANEL
- LED RGB
- MANDO A DISTANCIA

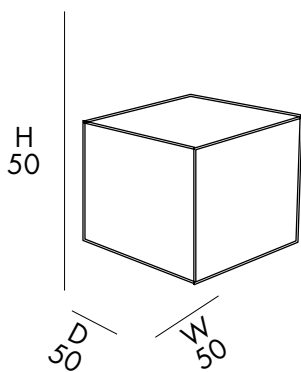

5,5 Kg



D 55 cm
H 55 cm
W 55 cm



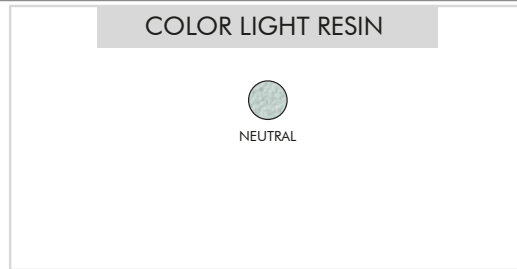

TWIST SL

DP8068/SOLARE

COMPLEMENTO D'ARREDO LUMINOSO

- VERSIONE LUMINOSA FOTOVOLTAICA
- REALIZZATA IN POLIETILENE IN MASSA
- LED RGB
- TELECOMANDO

BRIGHT FURNITURE COMPLEMENT

- PHOTOVOLTAIC LIGHT VERSION
- MADE IN HD MASS POLYETHYLENE
- LED RGB
- REMOTE CONTROL

ACCESSOIRE D'AMEUBLEMENT

- VERSION LUMINEUSE PHOTOVOLTAÏQUE
- FABRIQUÉE EN POLYÉTHYLÈNE MASSIVE
- LED RGB
- TELECOMMANDE

ACCESORIO DE MOBILIARIO LUMINOSOS

- VERSIÓN LUMINOSA FOTOVOLTAICA
- REALIZADA EN POLIETILENO A GRANEL
- LED RGB
- MANDO A DISTANCIA

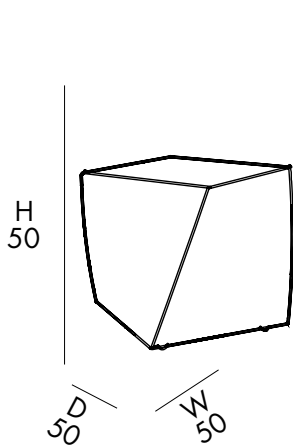

5,5 Kg



D 55 cm
H 55 cm
W 55 cm



COLOR LIGHT RESIN



QUADRO 86 SL

ART1927/SOLARE

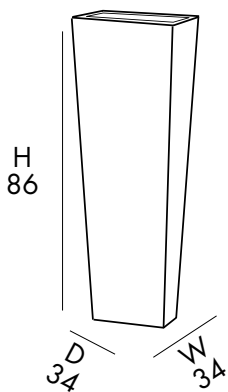

4 Kg



D 60 cm
H 90 cm
W 60 cm



VASO

- VERSIONE LUMINOSA FOTOVOLTAICA
- REALIZZATO IN POLIETILENE IN MASSA
- LED RGB
- CAPIENZA 23,5 LT
- TELECOMANDO

POT

- PHOTOVOLTAIC LIGHT VERSION
- MADE IN HD MASS POLYETHYLENE
- LED RGB
- CAPACITY 23,5 LT
- REMOTE CONTROL

VASE

- VERSION LUMINEUSE PHOTOVOLTAÏQUE
- FABRIQUÉ EN POLYÉTHYLÈNE MASSIVE
- LED RGB
- CAPACITÉ 23,5 LT
- TELECOMMANDE

JARRÓN

- VERSIÓN LUMINOSA FOTOVOLTAICA
- REALIZADO EN POLIETILENO A GRANEL
- LED RGB
- CAPACIDAD 23,5 LT
- MANDO A DISTANCIA



COLOR LIGHT RESIN



NEUTRAL

QUADRO 102 SL

ART1926/SOLAR

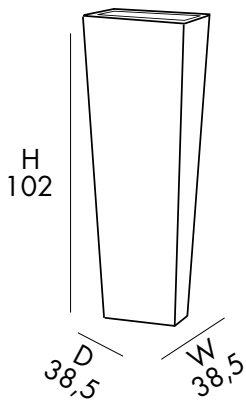

5,5 Kg



D 60 cm
H 120 cm
W 60 cm



VASO

- VERSIONE LUMINOSA FOTOVOLTAICA
- REALIZZATO IN POLIETILENE IN MASSA
- LED RGB
- CAPIENZA 40 LT
- TELECOMANDO



POT

- PHOTOVOLTAIC LIGHT VERSION
- MADE IN HD MASS POLYETHYLENE
- LED RGB
- CAPACITY 40 LT
- REMOTE CONTROL

VASE

- VERSION LUMINEUSE PHOTOVOLTAÏQUE
- FABRIQUÉ EN POLYÉTHYLÈNE MASSIVE
- LED RGB
- CAPACITÉ 40 LT
- TELECOMMANDE



JARRÓN

- VERSIÓN LUMINOSA FOTOVOLTAICA
- REALIZADO EN POLIETILENO A GRANEL
- LED RGB
- CAPACIDAD 40 LT
- MANDO A DISTANCIA



COLOR LIGHT RESIN



NEUTRAL

TONDO 86 SL

AR1914/SOLARE

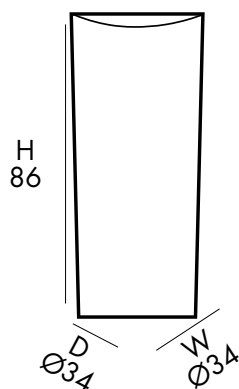

4 Kg



D 60 cm
H 90 cm
W 60 cm



VASO

- VERSIONE LUMINOSA FOTOVOLTAICA
- REALIZZATO IN POLIETILENE IN MASSA
- LED RGB
- CAPIENZA 21 LT
- TELECOMANDO

POT

- PHOTOVOLTAIC LIGHT VERSION
- MADE IN HD MASS POLYETHYLENE
- LED RGB
- CAPACITY 21 LT
- REMOTE CONTROL

VASE

- VERSION LUMINEUSE PHOTOVOLTAÏQUE
- FABRIQUÉ EN POLYÉTHYLÈNE MASSIVE
- LED RGB
- CAPACITÉ 21 LT
- TELECOMMANDE

JARRÓN

- VERSIÓN LUMINOSA FOTOVOLTAICA
- REALIZADO EN POLIETILENO A GRANEL
- LED RGB
- CAPACIDAD 21 LT
- MANDO A DISTANCIA



COLOR LIGHT RESIN



NEUTRAL

TONDO 102 SL

ART 1925/SOLARE

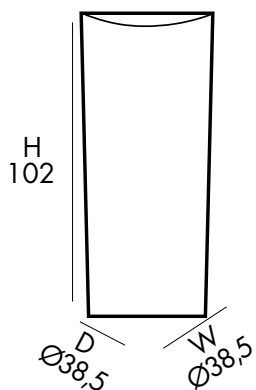

5,5 Kg



D 60 cm
H 120 cm
W 60 cm



VASO

- VERSIONE LUMINOSA FOTOVOLTAICA
- REALIZZATO IN POLIETILENE IN MASSA
- LED RGB
- CAPIENZA 35 LT
- TELECOMANDO

POT

- PHOTOVOLTAIC LIGHT VERSION
- MADE IN HD MASS POLYETHYLENE
- LED RGB
- CAPACITY 35 LT
- REMOTE CONTROL

VASE

- VERSION LUMINEUSE PHOTOVOLTAÏQUE
- FABRIQUÉ EN POLYÉTHYLÈNE MASSIVE
- LED RGB
- CAPACITÉ 35 LT
- TELECOMMANDE

JARRÓN

- VERSIÓN LUMINOSA FOTOVOLTAICA
- REALIZADO EN POLIETILENO A GRANEL
- LED RGB
- CAPACIDAD 35 LT
- MANDO A DISTANCIA



COLOR LIGHT RESIN



NEUTRAL

OSCA SL

DP8069/SOLARE

COMPLEMENTO D'ARREDO LUMINOSO

- VERSIONE LUMINOSA FOTOVOLTAICA
- REALIZZATO IN POLIETILENE IN MASSA
- LED RGB
- TELECOMANDO

BRIGHT FURNITURE COMPLEMENT

- PHOTOVOLTAIC LIGHT VERSION
- MADE IN HD MASS POLYETHYLENE
- LED RGB
- REMOTE CONTROL

ACCESSOIRE D'AMEUBLEMENT

- VERSION LUMINEUSE PHOTOVOLTAÏQUE
- FABRIQUÉE EN POLYÉTHYLÈNE MASSIVE
- LED RGB
- TELECOMMANDE

ACCESORIO DE MOBILIARIO LUMINOSOS

- VERSIÓN LUMINOSA FOTOVOLTAICA
- REALIZADA EN POLIETILENO A GRANEL
- LED RGB
- MANDO A DISTANCIA



3 Kg



D 50 cm
H 87 cm
W 50 cm

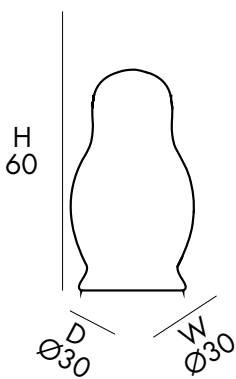

COLOR LIGHT RESIN



IRIS COMFORT SL

DP1929/COMFORT/SOLAR

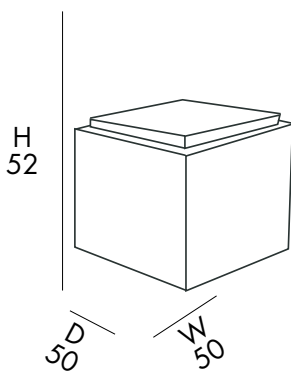

6 Kg



D 55 cm
H 55 cm
W 55 cm



SEDUTA MODULARE

- VERSIONE LUMINOSA FOTOVOLTAICA
- REALIZZATA IN POLIETILENE IN MASSA
- LED RGB
- COLORE CUSCINO SOLO NERO
- CUSCINO IN ECO-PELLE IMBOTTITO
- TELECOMANDO

MODULAR SEAT

- PHOTOVOLTAIC LIGHT VERSION
- MADE IN HD MASS POLYETHYLENE
- LED RGB
- CUSHION COLOUR ONLY BLACK
- PADDED ECO-LEATHER CUSHION
- REMOTE CONTROL

SIÈGE MODULAIRE

- VERSION LUMINEUSE PHOTOVOLTAÏQUE
- FABRIQUÉE EN POLYÉTHYLÈNE MASSIVE
- LED RGB
- COULEUR DU COUSSIN UNIQUEMENT NOIR
- COUSSIN REMBOURRÉ EN CUIR ÉCOLOGIQUE
- TELECOMMANDE

ANSIETO MODULAR

- VERSIÓN LUMINOSA FOTOVOLTAICA
- REALIZADA EN POLIETILENO A GRANEL
- LED RGB
- COLOR DEL COJÍN SÓLO NEGRO
- COJÍN ACOLCHADO EN PIEL ECOLÓGICA
- MANDO A DISTANCIA

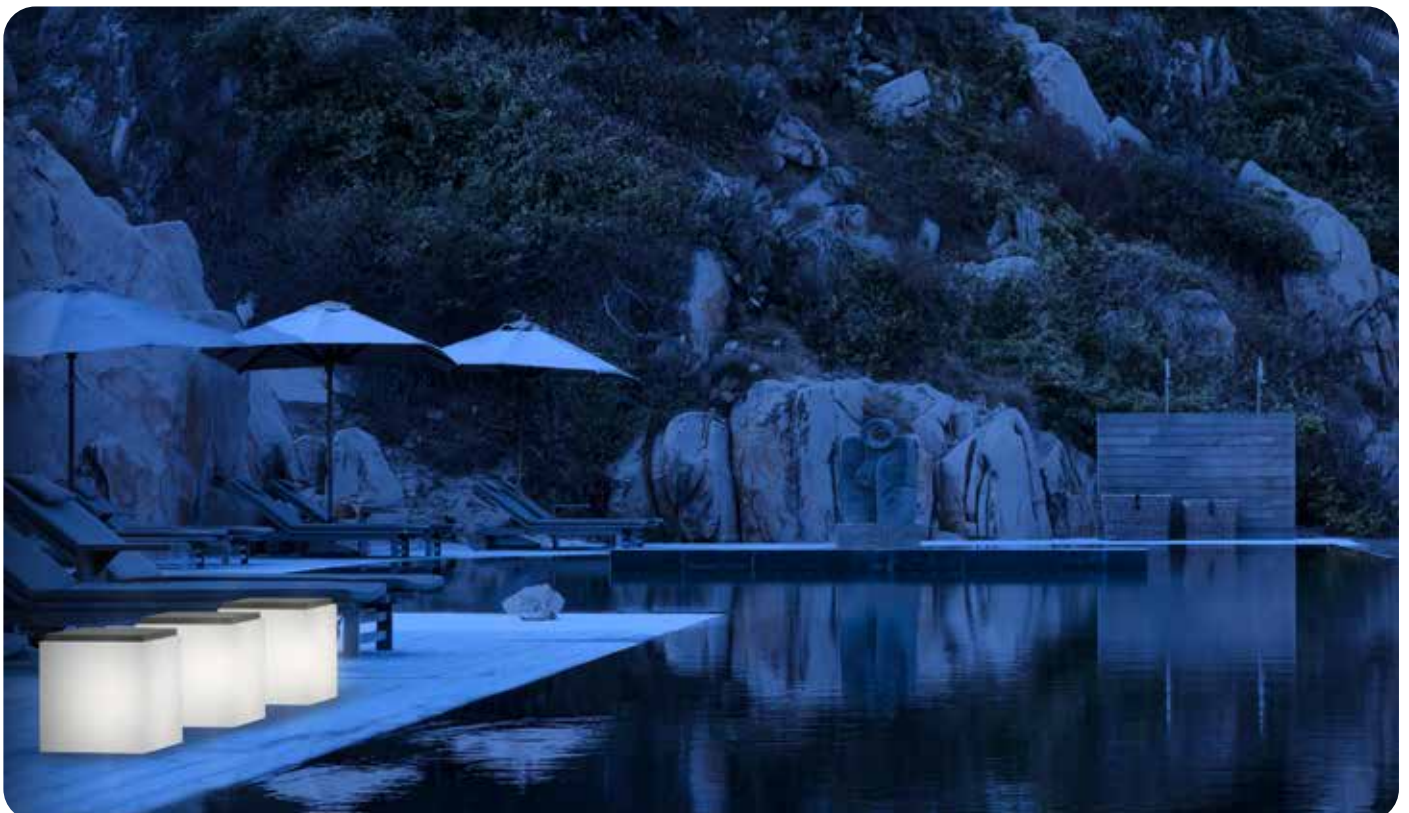

COLOR LIGHT RESIN



NEUTRAL

PINO SL MEDIO

DP2225/SOLARE

COMPLEMENTO D'ARREDO LUMINOSO

- VERSIONE LUMINOSA FOTOVOLTAICA
- REALIZZATO IN POLIETILENE IN MASSA
- LED RGB
- TELECOMANDO

BRIGHT FURNITURE COMPLEMENT

- PHOTOVOLTAIC LIGHT VERSION
- MADE IN HD MASS POLYETHYLENE
- LED RGB
- REMOTE CONTROL

ACCESSOIRE D'AMEUBLEMENT

- VERSION LUMINEUSE PHOTOVOLTAÏQUE
- FABRIQUÉ EN POLYÉTHYLÈNE MASSIVE
- LED RGB
- TELECOMMANDE

ACCESORIO DE MOBILIARIO LUMINOSOS

- VERSIÓN LUMINOSA FOTOVOLTAICA
- REALIZADA EN POLIETILENO A GRANEL
- LED RGB
- MANDO A DISTANCIA

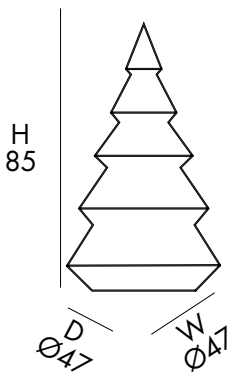

4 Kg



D 50 cm
H 87 cm
W 50 cm



COLOR LIGHT RESIN



FELIX SL

DP1550/SOLARE

COMPLEMENTO D'ARREDO LUMINOSO

- VERSIONE LUMINOSA FOTOVOLTAICA
- REALIZZATO IN POLIETILENE IN MASSA
- LED RGB
- TELECOMANDO

BRITAIN BRIGHT FURNITURE COMPLEMENT

- PHOTOVOLTAIC LIGHT VERSION
- MADE IN HD MASS POLYETHYLENE
- LED RGB
- REMOTE CONTROL

ACCESSOIRE D'AMEUBLEMENT

- VERSION LUMINEUSE PHOTOVOLTAÏQUE
- FABRIQUÉ EN POLYÉTHYLÈNE MASSIVE
- LED RGB
- TELECOMMANDE

ACCESORIO DE MOBILIARIO LUMINOSOS

- VERSIÓN LUMINOSA FOTOVOLTAICA
- REALIZADO EN POLIETILENO A GRANEL
- LED RGB
- MANDO A DISTANCIA

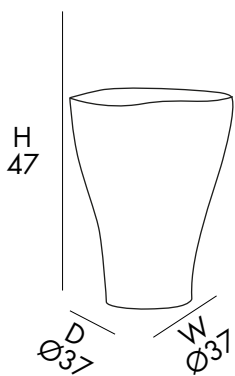

5 Kg



D 55 cm
H 55 cm
W 55 cm



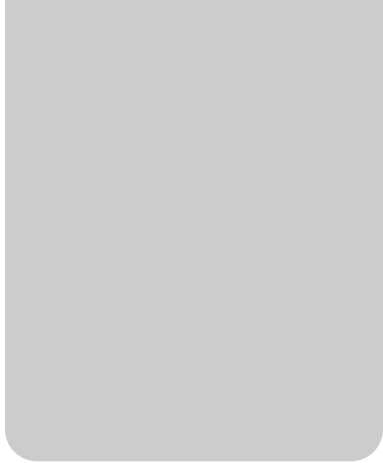

Una storia di successi dal 1988
A story of successes since 1988

ARKEMA®
DESIGN

MADE IN ITALY

Sostenibili per natura
Sustainable by nature



NATURA LINE



COLORS

STANDARD COLORS RESIN

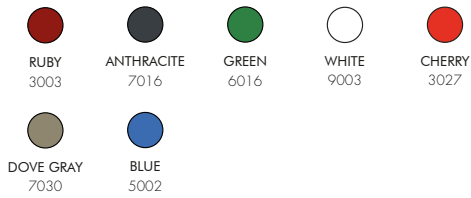

RAL LACQUARED



*SU RICHIESTA RAL LACCATA/
ANY RAL LACQUERED

**PREZZO SU RICHIESTA/
PRICE ONE REQUEST**

POT XL

DP1660

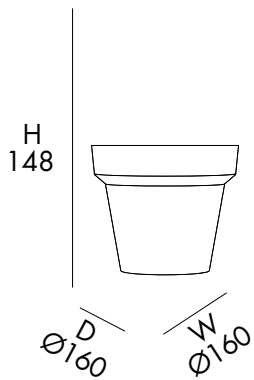

40 Kg



D 160 cm
H 163 cm
W 116 cm



VASO

- OUTDOOR
- REALIZZATO IN POLIETILENE COLORATO IN MASSA
- CAPACITÀ 3.500 LT

POT

- OUTDOOR
- MADE IN HD MASS COLOURED POLYETHYLENE
- CAPACITY 3.500 LT

VASE







- OUTDOOR
- FABRIQUÉ EN POLYÉTHYLÈNE COLORÉE DANS LA MASSE
- CAPACITÉ 3.500 LT

JARRÓN

- OUTDOOR
- REALIZADA EN POLIETILENO COLOREADO A GRANEL EN MASE
- CAPACIDAD 3.500 LT



COLORS

STANDARD COLORS RESIN				
 RUBY 3003	 ANTHRACITE 7016	 GREEN 6016	 WHITE 9003	 CHERRY 3027
 DOVE GRAY 7030	 BLUE 5002			

RAL LACQUARED



ON
REQUEST

*SU RICHIESTA RAL LACCATA/
ANY RAL LACQUERED

PREZZO SU RICHIESTA/
PRICE ONE REQUEST

POT L

DP1659

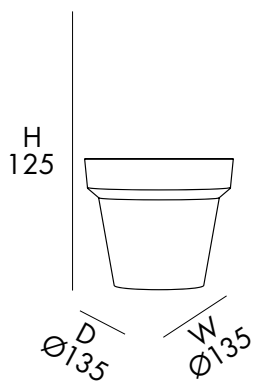

35 Kg



D 135 cm
H 140 cm
W 104 cm



VASO

- OUTDOOR
- REALIZZATO IN POLIETILENE COLORATO IN MASSA
- CAPACITÀ 2.100 LT

POT

- OUTDOOR
- MADE IN HD MASS COLOURED POLYETHYLENE
- CAPACITY 2.100 LT

VASE

- OUTDOOR
- FABRIQUÉ EN POLYÉTHYLÈNE COLORÉE DANS LA MASSE
- CAPACITÉ 2.100 LT

JARRÓN

- OUTDOOR
- REALIZADO EN POLIETILENO COLOREADO A GRANEL EN MASE
- CAPACIDAD 2.100 LT



COLORS

STANDARD COLORS RESIN

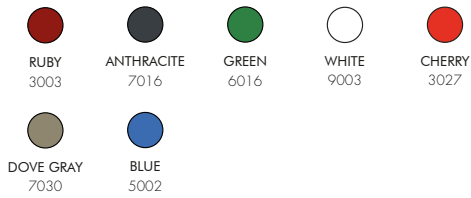

RAL LACQUARED



*SU RICHIESTA RAL LACCATA/
ANY RAL LACQUERED

**PREZZO SU RICHIESTA/
PRICE ONE REQUEST**

POT M

DP1658

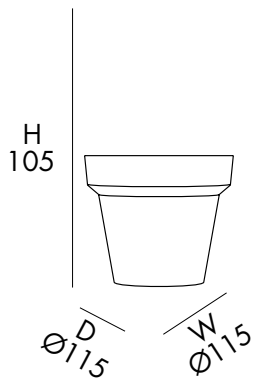

25 Kg



D 115 cm
H 120 cm
W 90 cm



VASO

- OUTDOOR
- REALIZZATO IN POLIETILENE COLORATO IN MASSA
- CAPIENZA 1.260 LT

POT

- OUTDOOR
- MADE IN HD MASS COLOURED POLYETHYLENE
- CAPACITY 1.260 LT

VASE







- OUTDOOR
- FABRIQUÉ EN POLYÉTHYLÈNE COLORÉE DANS LA MASSE
- CAPACITÉ 1.260 LT

JARRÓN

- OUTDOOR
- REALIZADO EN POLIETILENO COLOREADO A GRANUL EN MASE
- CAPACIDAD 1.260 LT



COLORS

STANDARD COLORS RESIN				
 RUBY 3003	 ANTHRACITE 7016	 GREEN 6016	 WHITE 9003	 CHERRY 3027
 DOVE GRAY 7030	 BLUE 5002			

RAL LACQUARED



*SU RICHIESTA RAL LACCATA/
ANY RAL LACQUERED

PREZZO SU RICHIESTA/
PRICE ONE REQUEST

POT S

DP1657

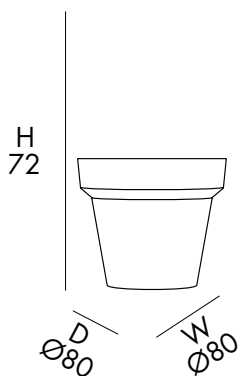

25 Kg



D 115 cm
H 120 cm
W 90 cm



VASO

- OUTDOOR
- REALIZZATO IN POLIETILENE COLORATO IN MASSA
- CAPACITÀ 410 LT

POT

- OUTDOOR
- MADE IN HD MASS COLOURED POLYETHYLENE
- CAPACITY 410 LT

VASE

- OUTDOOR
- FABRIQUÉ EN POLYÉTHYLÈNE COLORÉE DANS LA MASSE
- CAPACITÉ 410 LT

JARRÓN

- OUTDOOR
- REALIZADA EN POLIETILENO COLOREADO A GRANTEL EN MASE
- CAPACIDAD 410 LT



COLORS

STANDARD COLORS RESIN

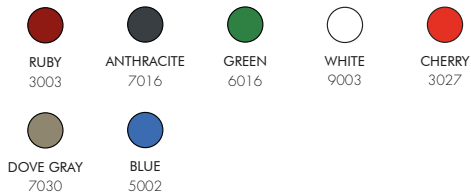

RAL LACQUARED



*SU RICHIESTA RAL LACCATA/
ANY RAL LACQUERED

**PREZZO SU RICHIESTA/
PRICE ONE REQUEST**

QUADRO 86

AR1927

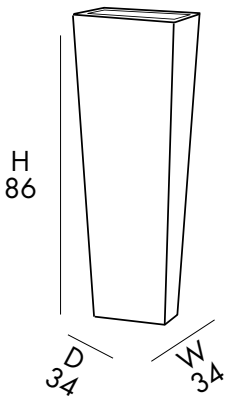

4 Kg



D 60 cm
H 90 cm
W 60 cm



VASO

- OUTDOOR
- REALIZZATO IN POLIETILENE COLORATO IN MASSA
- CAPIENZA 23 LT

POT

- OUTDOOR
- MADE IN HD MASS COLOURED POLYETHYLENE
- CAPACITY 23 LT

VASE







- OUTDOOR
- FABRIQUÉ EN POLYÉTHYLÈNE COLORÉE DANS LA MASSE
- CAPACITÉ 23 LT

JARRÓN

- OUTDOOR
- REALIZADO EN POLIETILENO COLOREADO A GRANEL EN MASE
- CAPACIDAD 23 LT



COLORS

STANDARD COLORS RESIN				
				
RUBY 3003	ANTHRACITE 7016	GREEN 6016	WHITE 9003	CHERRY 3027
				
DOVE GRAY 7030	BLUE 5002			

RAL LACQUARED



ON
REQUEST

*SU RICHIESTA RAL LACCATA/
ANY RAL LACQUERED

PREZZO SU RICHIESTA/
PRICE ONE REQUEST

QUADRO 102

AR1926

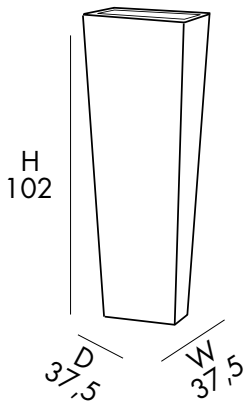

5,5 Kg



D 60 cm
H 120 cm
W 60 cm



VASO

- OUTDOOR
- REALIZZATO IN POLIETILENE COLORATO IN MASSA
- CAPACITÀ 40 LT

POT

- OUTDOOR
- MADE IN HD MASS COLOURED POLYETHYLENE
- CAPACITY 40 LT

VASE







- OUTDOOR
- FABRIQUÉ EN POLYÉTHYLÈNE COLORÉE DANS LA MASSE
- CAPACITÉ 40 LT

JARRÓN

- OUTDOOR
- REALIZADA EN POLIETILENO COLOREADO A GRANDEL EN MASE
- CAPACIDAD 40 LT



COLORS

STANDARD COLORS RESIN				
 RUBY 3003	 ANTHRACITE 7016	 GREEN 6016	 WHITE 9003	 CHERRY 3027
 DOVE GRAY 7030	 BLUE 5002			

RAL LACQUARED



ON
REQUEST

*SU RICHIESTA RAL LACCATA/
ANY RAL LACQUERED

**PREZZO SU RICHIESTA/
PRICE ONE REQUEST**

TONDO 86

AR1914

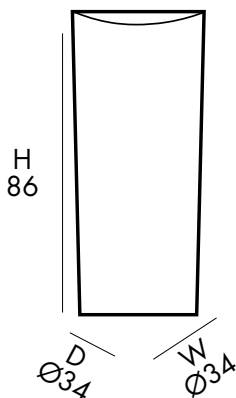

4 Kg



D 60 cm
H 90 cm
W 60 cm



VASO

- OUTDOOR
- REALIZZATO IN POLIETILENE COLORATO IN MASSA
- CAPIENZA 21 LT

POT

- OUTDOOR
- MADE IN HD MASS COLOURED POLYETHYLENE
- CAPACITY 21 LT

VASE







- OUTDOOR
- FABRIQUÉ EN POLYÉTHYLÈNE COLORÉE DANS LA MASSE
- CAPACITÉ 21 LT

JARRÓN

- OUTDOOR
- REALIZADO EN POLIETILENO COLOREADO A GRANEL EN MASE
- CAPACIDAD 21 LT



COLORS

STANDARD COLORS RESIN				
 RUBY 3003	 ANTHRACITE 7016	 GREEN 6016	 WHITE 9003	 CHERRY 3027
 DOVE GRAY 7030	 BLUE 5002			

RAL LACQUARED



ON
REQUEST

*SU RICHIESTA RAL LACCATA/
ANY RAL LACQUERED

PREZZO SU RICHIESTA/
PRICE ONE REQUEST

TONDO 102

AR1925

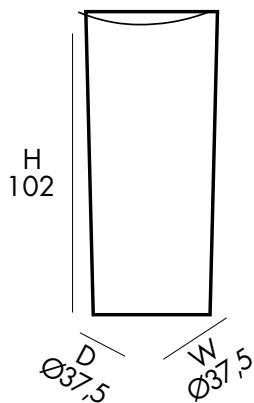

5,5 Kg



D 60 cm
H 120 cm
W 60 cm



recycled or
recyclable

VASO

- OUTDOOR
- REALIZZATO IN POLIETILENE COLORATO IN MASSA
- CAPACITÀ 35 LT

POT

- OUTDOOR
- MADE IN HD MASS COLOURED POLYETHYLENE
- CAPACITY 35 LT

VASE







- OUTDOOR
- FABRIQUÉ EN POLYÉTHYLÈNE COLORÉE DANS LA MASSE
- CAPACITÉ 35 LT

JARRÓN

- OUTDOOR
- REALIZADO EN POLIETILENO COLOREADO A GRANEL EN MASE
- CAPACIDAD 35 LT



COLORS

STANDARD COLORS RESIN				
 RUBY 3003	 ANTHRACITE 7016	 GREEN 6016	 WHITE 9003	 CHERRY 3027
 DOVE GRAY 7030	 BLUE 5002			

RAL LACQUARED



ON
REQUEST

*SU RICHIESTA RAL LACCATA/
ANY RAL LACQUERED

PREZZO SU RICHIESTA/
PRICE ONE REQUEST

TUMMY VASE

DP8070

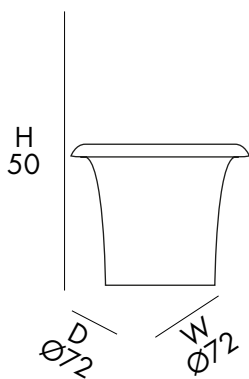

7,5 Kg



D 120 cm
H 70 cm
W 80 cm



VASO

- OUTDOOR
- REALIZZATO IN POLIETILENE COLORATO IN MASSA
- CAPIENZA 180 LT

POT

- OUTDOOR
- MADE IN HD MASS COLOURED POLYETHYLENE
- CAPACITY 180 LT

VASE







- OUTDOOR
- FABRIQUÉ EN POLYÉTHYLÈNE COLORÉE DANS LA MASSE
- CAPACITÉ 180 LT

JARRÓN

- OUTDOOR
- REALIZADA EN POLIETILENO COLOREADO A GRANEL EN MASE
- CAPACIDAD 180 LT



COLORS

STANDARD COLORS RESIN				
				
RUBY 3003	ANTHRACITE 7016	GREEN 6016	WHITE 9003	CHERRY 3027
				
DOVE GRAY 7030	BLUE 5002			

RAL LACQUARED



*SU RICHIESTA RAL LACCATA/
ANY RAL LACQUERED

PREZZO SU RICHIESTA/
PRICE ONE REQUEST

IRIS VASE

DP1929/VASE

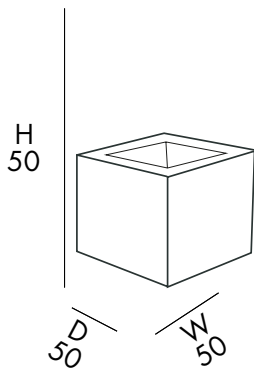

5,5 Kg



D 55 cm
H 55 cm
W 55 cm



VASO

- OUTDOOR
- REALIZZATO IN POLIETILENE COLORATO IN MASSA
- CAPACITÀ 8 LT

POT

- OUTDOOR
- MADE IN HD MASS COLOURED POLYETHYLENE
- CAPACITY 8 LT

VASE

- OUTDOOR
- FABRIQUÉ EN POLYÉTHYLÈNE COLORÉE DANS LA MASSE
- CAPACITÉ 8 LT

JARRÓN

- OUTDOOR
- REALIZADA EN POLIETILENO COLOREADO A GRANEL EN MASE
- CAPACIDAD 8 LT



COLORS

STANDARD COLORS RESIN



WHITE
9003



ANTHRACITE
7016

RAL LACQUARED



ON
REQUEST

*SU RICHIESTA RAL LACCATA/
ANY RAL LACQUERED

PREZZO SU RICHIESTA/
PRICE ONE REQUEST

MODULO CASSETTA

AR1923

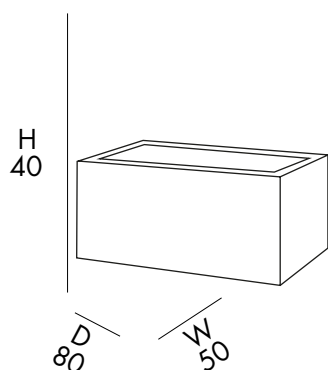

12 Kg



D 120 cm
H 70 cm
W 80 cm



recycled or
recyclable

VASO

- OUTDOOR
- REALIZZATO IN POLIETILENE COLORATO IN MASSA
- CAPACITÀ 85 LT

POT

- OUTDOOR
- MADE IN HD MASS COLOURED POLYETHYLENE
- CAPACITY 85 LT

VASE

- OUTDOOR
- FABRIQUÉ EN POLYÉTHYLÈNE COLORÉE DANS LA MASSE
- CAPACITÉ 85 LT

JARRÓN

- OUTDOOR
- REALIZADO EN POLIETILENO COLOREADO A GRANEL EN MASE
- CAPACIDAD 85 LT



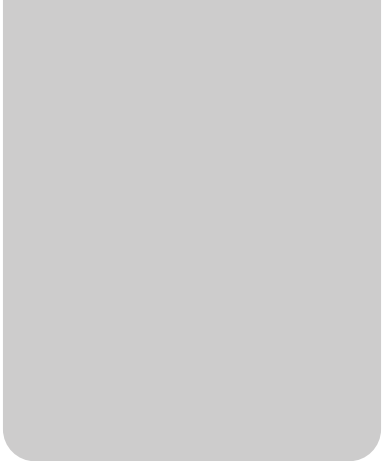

Una storia di successi dal 1988
A story of successes since 1988

ARKEMA®
DESIGN

MADE IN ITALY

Sostenibili per natura
Sustainable by nature



It's
so good

**COMFORT
LINE**



COLORS

STANDARD COLORS RESIN



WHITE
9003



ANTHRACITE
7016

RAL LACQUARED



ON
REQUEST

*SU RICHIESTA RAL LACCATA/
ANY RAL LACQUERED

PREZZO SU RICHIESTA/
PRICE ONE REQUEST

DRINK

DP1548

SEVETTO Design by Elli A.

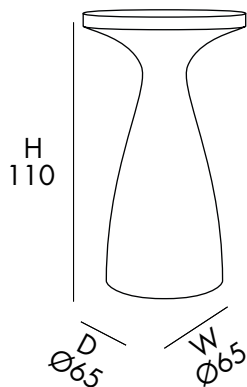

14 Kg



D 65 cm
H 140 cm
W 65 cm



recycled or
recyclable

TAVOLO ALTO

- OUTDOOR
- REALIZZATO IN POLIETILENE COLORATA IN MASSA

HIGH TABLE

- OUTDOOR
- MADE IN HD MASS COLOURED POLYETHYLENE

TABLE HAUTE

- OUTDOOR
- FABRIQUÉE EN POLYÉTHYLÈNE COLORÉE DANS LA MASSE

JARRÓN

- OUTDOOR
- REALIZADA EN POLIETILENO COLOREADO A GRANEL EN MASE



COLORS

STANDARD COLORS RESIN

WHITE
9003

ANTHRACITE
7016

RAL LACQUARED

ON
REQUEST

*SU RICHIESTA RAL LACCATA/
ANY RAL LACQUERED

PREZZO SU RICHIESTA/
PRICE ONE REQUEST

KALISPERA

DP1549

SEVETTO Design by Elli A.

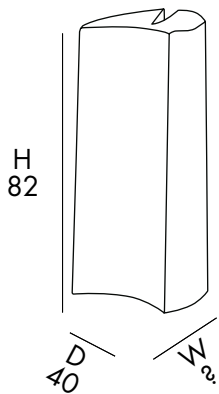

6 Kg



D 43,5 cm
H 84,5 cm
W 43,5 cm



SGABELLO ALTO

- OUTDOOR
- REALIZZATO IN POLIETILENE COLORATA IN MASSA
- DOTATO DI MANIGLIA E POGGIA PIEDI

HIGH FOOTSTOOL

- OUTDOOR
- MADE IN HD MASS COLOURED POLYETHYLENE
- EQUIPPED WITH HANDLE AND FOOT REST

TABOURET HAUT

- OUTDOOR
- FABRIQUÉ EN POLYÉTHYLÈNE COLORÉE DANS LA MASSE
- ÉQUIPÉ D'UNE POIGNÉE ET D'UN REPOSE-PIEDS

ESCABEL ALTO

- OUTDOOR
- REALIZADA EN POLIETILENO COLOREADO A GRANEL EN MASE
- EQUIPADO CON ASA Y REPOSAPIÉS



COLORS

STANDARD COLORS RESIN

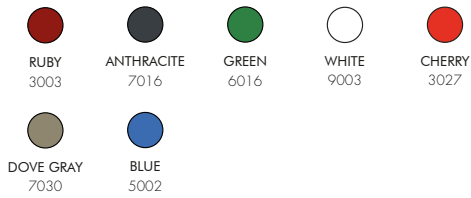

RAL LACQUARED



*SU RICHIESTA RAL LACCATA/
ANY RAL LACQUERED

**PREZZO SU RICHIESTA/
PRICE ONE REQUEST**

FELIX

DP1550

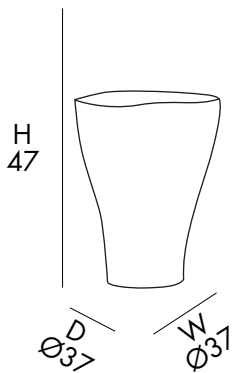

5 Kg



D 55 cm
H 55 cm
W 55 cm



SGABELLO

- OUTDOOR
- REALIZZATO IN POLIETILENE COLORATA IN MASSA

FOOTSTOOL

- OUTDOOR
- MADE IN HD MASS COLOURED POLYETHYLENE

TABOURET







- OUTDOOR
- FABRIQUÉ EN POLYÉTHYLÈNE COLORÉE DANS LA MASSE

ESCABEL

- OUTDOOR
- REALIZADA EN POLIETILENO COLOREADA A GRANEL EN MASE



COLORS

STANDARD COLORS RESIN				
				
RUBY 3003	ANTHRACITE 7016	GREEN 6016	WHITE 9003	CHERRY 3027
				
DOVE GRAY 7030	BLUE 5002			

RAL LACQUARED



*SU RICHIESTA RAL LACCATA/
ANY RAL LACQUERED

PREZZO SU RICHIESTA/
PRICE ONE REQUEST

ALTHEA

DP1472

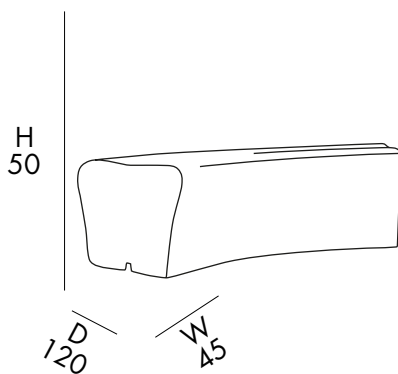

18 Kg



D 160 cm
H 60 cm
W 120 cm

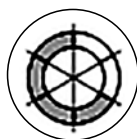

SEDUTA MODULARE

- OUTDOOR
- REALIZZATA IN POLIETILENE COLORATA IN MASSA
- SI POSSONO ASSEMBLARE TRA LORO TRAMITE UN "GIUNTO". (IMMAGINE NEI CERCHI)



MODULAR SEAT

- OUTDOOR
- MADE IN HD MASS COLOURED POLYETHYLENE
- CAN BE ASSEMBLED TOGETHER BY A "COUPLING". (IMAGE IN CIRCLES)

SIÈGE MODULAIRE

- OUTDOOR
- FABRIQUÉ EN HD MASS COLOURÉE DANS LA MASSE
- LES SIÈGES PEUVENT ÊTRE ASSEMBLÉS AU MOYEN D'UN "COUPLAGE". (IMAGE EN CERCLES)



ASIENTO MODULAR

- OUTDOOR
- REALIZADA EN POLIETILENO COLOREADA A GRANTEL EN MASE
- PUEDEN ENSAMBLARSE MEDIANTE UN "ENGANCHE". (IMAGEN EN CÍRCULOS)



COLORS

STANDARD COLORS RESIN



WHITE
9003



ANTHRACITE
7016

RAL LACQUARED



ON
REQUEST

*SU RICHIESTA RAL LACCATA/
ANY RAL LACQUERED

PREZZO SU RICHIESTA/
PRICE ONE REQUEST

OLIMPO

DP1544

SEVETTO Design by Ballabio C. - Elli A.

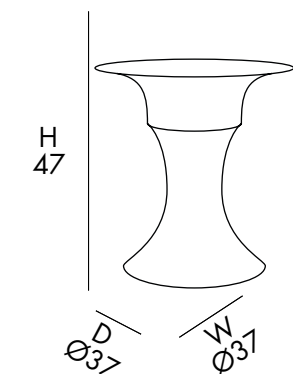

9,5 Kg



D 120 cm
H 70 cm
W 80 cm



TAVOLO componibile

- OUTDOOR
- REALIZZATO IN POLIETILENE COLORATA IN MASSA
- IL PRODOTTO È SMONTABILE IN DUE PEZZI



MODULAR TABLE

- OUTDOOR
- MADE IN HD MASS COLOURED POLYETHYLENE
- THE PRODUCT CAN BE DIVIDED IN TWO PIECES

TABLE MODULAIRE

- OUTDOOR
- FABRIQUÉE EN POLYÉTHYLÈNE COLORÉE DANS LA MASSE
- LE PRODUIT EST DÉMONTABLE EN DEUX PIÈCES



MESA MODULAR

- OUTDOOR
- REALIZADA EN POLIETILENO COLOREADA A GRANUL EN MASA
- EL PRODUCTO ES DESMONTABLE EN DOS PIEZAS



COLORS

STANDARD COLORS RESIN



WHITE
9003



ANTHRACITE
7016

RAL LACQUARED



ON
REQUEST

*SU RICHIESTA RAL LACCATA/
ANY RAL LACQUERED

PREZZO SU RICHIESTA/
PRICE ONE REQUEST

LADY

DP1545

SEVETTO Design by Ballabio C. - Elli A.

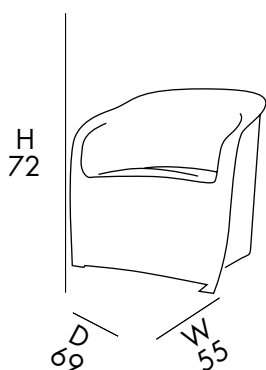

13 Kg



D 120 cm
H 70 cm
W 80 cm



POLTRONA

- OUTDOOR
- REALIZZATA IN POLIETILENE COLORATA IN MASSA

ARMCHAIR

- OUTDOOR
- MADE IN HD MASS COLOURED POLYETHYLENE

FAUTEUIL







- OUTDOOR
- FABRIQUÉ EN POLYÉTHYLÈNE COLORÉE DANS LA MASSE

SILLÓN

- OUTDOOR
- REALIZADA EN POLIETILENO COLOREADA A GRANUL EN MASA



COLORS

STANDARD COLORS RESIN				
				
RUBY 3003	ANTHRACITE 7016	GREEN 6016	WHITE 9003	CHERRY 3027
				
DOVE GRAY 7030	BLUE 5002			

RAL LACQUARED



ON
REQUEST

*SU RICHIESTA RAL LACCATA/
ANY RAL LACQUERED

PREZZO SU RICHIESTA/
PRICE ONE REQUEST

IRIS POUF

DP1929

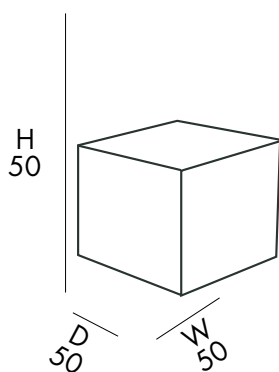

5,5 Kg



D 55 cm
H 55 cm
W 55 cm



TAVOLINO/SEDUTA MODULARE

- OUTDOOR
- REALIZZATA IN POLIETILENE COLORATA IN MASSA

TABLE/MODULAR SEAT

- OUTDOOR
- MADE IN HD MASS COLOURED POLYETHYLENE

TABLE/SIÈGE MODULAIRE







- OUTDOOR
- FABRIQUÉE EN POLYÉTHYLÈNE COLORÉE DANS LA MASSE

MESA/ASIENTO MODULAR

- OUTDOOR
- REALIZADA EN POLIETILENO COLOREADA A GRANEL EN MASE



COLORS

STANDARD COLORS RESIN				
				
RUBY 3003	ANTHRACITE 7016	GREEN 6016	WHITE 9003	CHERRY 3027
				
DOVE GRAY 7030	BLUE 5002			

RAL LACQUARED



ON
REQUEST

*SU RICHIESTA RAL LACCATA/
ANY RAL LACQUERED

PREZZO SU RICHIESTA/
PRICE ONE REQUEST

IRIS COMFORT

DP1929/COMFORT

SEDUTA MODULARE CON CUSCINO

- OUTDOOR
- REALIZZATA IN POLIETILENE COLORATA IN MASSA
- COLORE CUSCINO SOLO NERO
- CUSCINO IN ECO-PELLE IMBOTTITO



MODULAR SEAT WITH CUSHION

- OUTDOOR
- MADE IN HD MASS COLOURED POLYETHYLENE
- CUSHION COLOUR ONLY BLACK
- PADDED ECO-LEATHER CUSHION

SIÈGE MODULAIRE AVEC COUSSINET

- OUTDOOR
- FABRIQUÉE EN POLYÉTHYLÈNE COLORÉE DANS LA MASSE
- COULEUR DU COUSSIN UNIQUEMENT NOIR
- COUSSIN REMBOURRÉ EN CUIR ÉCOLOGIQUE

ASIENTO MODULAR CON CUSHION

- OUTDOOR
- REALIZADA EN POLIETILENO COLOREADA A GRANUL EN MASE
- COLOR DEL COJÍN SÓLO NEGRO
- COJÍN ACOLCHADO EN PIEL ECOLÓGICA

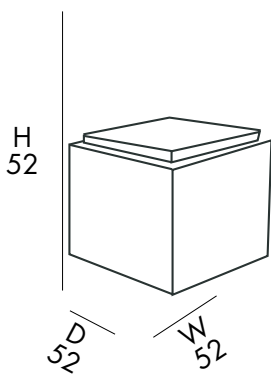

6 Kg









D 55 cm
H 55 cm
W 55 cm



recycled or
recyclable



COLORS

STANDARD COLORS RESIN				
 RUBY 3003	 ANTHRACITE 7016	 GREEN 6016	 WHITE 9003	 CHERRY 3027
 DOVE GRAY 7030	 BLUE 5002			

RAL LACQUARED



*SU RICHIESTA RAL LACCATA/
ANY RAL LACQUERED

**PREZZO SU RICHIESTA/
PRICE ONE REQUEST**

KAMI SGABELLO

DP8076

SGABELLO

- OUTDOOR
- REALIZZATO IN POLIETILENE COLORATO IN MASSA

FOOTSTOOL

- OUTDOOR
- MADE IN HD MASS COLOURED POLYETHYLENE

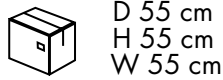
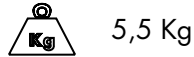
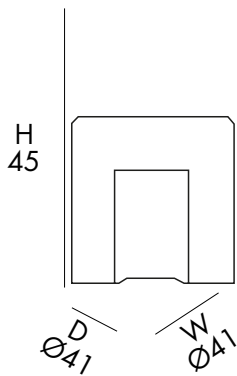

TABOURET







- OUTDOOR
- FABRIQUÉ EN POLYÉTHYLÈNE COLORÉE DANS LA MASSE

ESCABEL

- OUTDOOR
- REALIZADA EN POLIETILENO COLOREADA A GRANEL EN MASE



COLORS

STANDARD COLORS RESIN				
 RUBY 3003	 ANTHRACITE 7016	 GREEN 6016	 WHITE 9003	 CHERRY 3027
 DOVE GRAY 7030	 BLUE 5002			

RAL LACQUARED



*SU RICHIESTA RAL LACCATA/
ANY RAL LACQUERED

PREZZO SU RICHIESTA/
PRICE ONE REQUEST

GAIA SGABELLO

DP8077

SGABELLO

- OUTDOOR
- REALIZZATO IN POLIETILENE COLORATO IN MASSA

FOOTSTOOL

- OUTDOOR
- MADE IN HD MASS COLOURED POLYETHYLENE

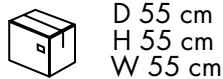
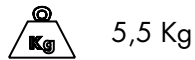
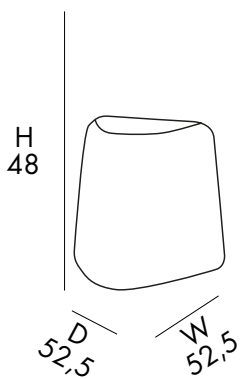

TABOURET

- OUTDOOR
- FABRIQUÉ EN POLYÉTHYLÈNE COLORÉE DANS LA MASSE

ESCABEL

- OUTDOOR
- REALIZADA EN POLIETILENO COLOREADA A GRANEL EN MASE



COLORS

STANDARD COLORS RESIN

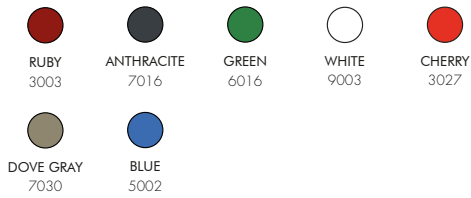

RAL LACQUARED



*SU RICHIESTA RAL LACCATA/
ANY RAL LACQUERED

**PREZZO SU RICHIESTA/
PRICE ONE REQUEST**

TWIST POUF

DP8068

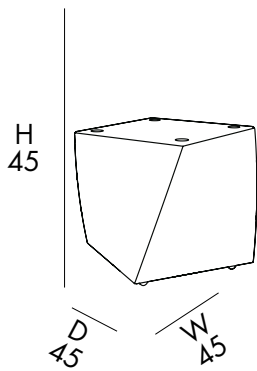

4 Kg



D 55 cm
H 55 cm
W 55 cm



SGABELLO

- OUTDOOR
- REALIZZATO IN POLIETILENE COLORATO IN MASSA

FOOTSTOOL

- OUTDOOR
- MADE IN HD MASS COLOURED POLYETHYLENE

TABOURET

- OUTDOOR
- FABRIQUÉ EN POLYÉTHYLÈNE COLORÉE DANS LA MASSE

ESCABEL

- OUTDOOR
- REALIZADA EN POLIETILENO COLOREADA A GRANEL EN MASE



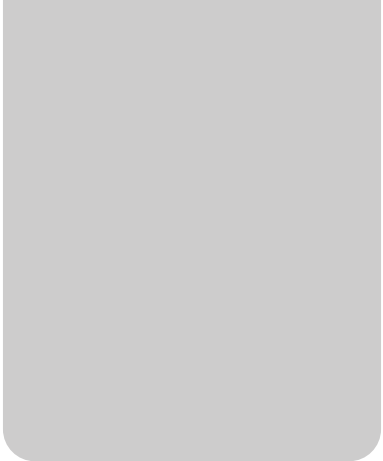

Una storia di successi dal 1988
A story of successes since 1988



Sostenibili per natura
Sustainable by nature



**STILE
LINE**



COLORS

STANDARD COLORS RESIN



WHITE
9003



ANTHRACITE
7016

RAL LACQUARED



ON
REQUEST

*SU RICHIESTA RAL LACCATA/
ANY RAL LACQUERED

PREZZO SU RICHIESTA/
PRICE ONE REQUEST

TULIPAN

DP1542

sevotto Design by Elli A.

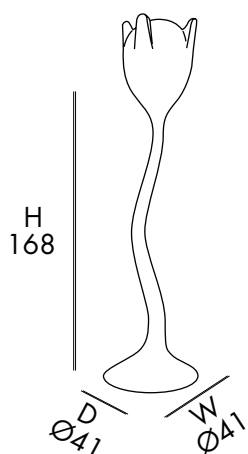

6 Kg



D 45 cm
H 171 cm
W 45 cm



recycled or
recyclable

PORTA ABITI

- OUTDOOR
- REALIZZATO IN POLIETILENE COLORATO IN MASSA

COAT HANGER

- OUTDOOR
- MADE IN HD MASS COLOURED POLYETHYLENE

PORTE MANTEAU

- OUTDOOR
- FABRIQUÉ EN POLYÉTHYLÈNE COLORÉE DANS LA MASSE

PERCHERO

- OUTDOOR
- REALIZADA EN POLIETILENO COLOREADO A GRANEL EN MASE



COLORS

STANDARD COLORS RESIN



WHITE
9003



ANTHRACITE
7016

RAL LACQUARED



ON
REQUEST

*SU RICHIESTA RAL LACCATA/
ANY RAL LACQUERED

PREZZO SU RICHIESTA/
PRICE ONE REQUEST

BOBO

DP1541

SEVETTO Design by Ballabio C. - Elli A.

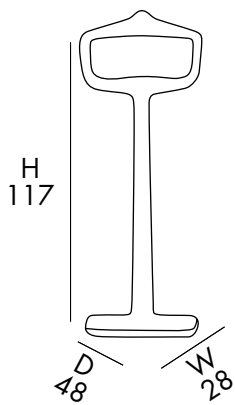

5 Kg



D 49 cm
H 120 cm
W 37 cm



PORTA ABITI

- OUTDOOR
- REALIZZATO IN POLIETILENE COLORATO IN MASSA



COAT HANGER

- OUTDOOR
- MADE IN HD MASS COLOURED POLYETHYLENE

PORTE MANTEAU

- OUTDOOR
- FABRIQUÉ EN POLYÉTHYLÈNE COLORÉE DANS LA MASSE



PERCHERO

- OUTDOOR
- REALIZADA EN POLIETILENO COLOREADO A GRANEL EN MASE



COLORS

STANDARD COLORS RESIN



WHITE
9003



ANTHRACITE
7016

RAL LACQUARED



ON
REQUEST

*SU RICHIESTA RAL LACCATA/
ANY RAL LACQUERED

PREZZO SU RICHIESTA/
PRICE ONE REQUEST

PISOLO

DP1540

SEVETTO Design by Ballabio C. - Elli A.

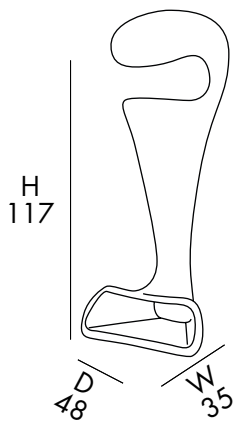

5 Kg



D 48 cm
H 118 cm
W 35,6 cm



PORTA ABITI

- OUTDOOR
- REALIZZATO IN POLIETILENE COLORATO IN MASSA
- SCOMPARTO PER SCARPE



COAT HANGER

- OUTDOOR
- MADE IN HD MASS COLOURED POLYETHYLENE
- SHOE COMPARTMENT

PORTE MANTEAU

- OUTDOOR
- FABRIQUÉ EN POLYÉTHYLÈNE COLORÉE DANS LA MASSE
- COMPARTIMENT À CHAUSSURES









PERCHERO

- OUTDOOR
- REALIZADA EN POLIETILENO COLOREADO A GRANDEL EN MASE
- COMPARTIMENTO PARA CALZADO



COLORS

STANDARD COLORS RESIN				
 RUBY 3003	 ANTHRACITE 7016	 GREEN 6016	 WHITE 9003	 CHERRY 3027
 DOVE GRAY 7030	 BLUE 5002			

RAL LACQUARED



*SU RICHIESTA RAL LACCATA/
ANY RAL LACQUERED

PREZZO SU RICHIESTA/
PRICE ONE REQUEST

ABETE S SMART

DP2226

COMPLEMENTO D'ARREDO

- OUTDOOR
- REALIZZATO IN POLIETILENE COLORATO IN MASSA

FURNISHING ACCESSORY

- OUTDOOR
- MADE IN HD MASS COLOURED POLYETHYLENE

ACCESSOIRE D'AMEUBLEMENT

- OUTDOOR
- FABRIQUÉ EN POLYÉTHYLÈNE COLORÉE DANS LA MASSE

ACCESORIO DE MOBILIARIO

- OUTDOOR
- REALIZADA EN POLIETILENO COLOREADO A GRANUL EN MASA

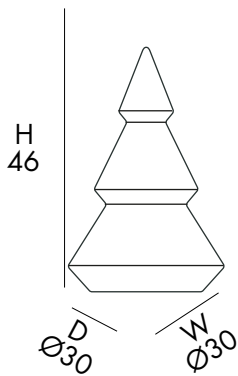

3,5 Kg



D 33 cm
H 48,5 cm
W 33 cm





UGO NESPOLO

Nespolo

 Ugo Nespolo negli Anni Sessanta fa parte della Galleria Schwarz di Milano che conta artisti come Duchamp, Picabia, Schwitters, Arman. La sua mostra milanese «Macchine e Oggetti Condizionali» presentata da Pierre Restany anticipa il clima che sarà dell'Arte Povera. A New York vive il clima Pop e l'incontro con Yoko Ono, Jonas Mekas, Andy Warhol, P. Adams Sitney dà il via a una folta produzione di film sperimentali proiettati nei maggiori centri artistici (Centre Pompidou, Tate Modern, Biennale di Venezia). Con Ben Vautier dà vita al primo Concerto Fluxus italiano. Il connubio di arte e vita è alla base dell'espressività di Nespolo e lo porta ad ampliare il suo campo d'azione creativa in ambiti disparati ed eclettici in cui è vivo l'amore per le arti applicate. Nel 2019 l'Università degli Studi di Torino gli conferisce la laurea Honoris Causa in Filosofia. Ha esposto in galleria e Musei in Italia e nel mondo.

 Ugo Nespolo was part of the Schwarz Gallery in Milan in the 1960s, which included artists such as Duchamp, Picabia, Schwitters and Arman. His Milan exhibition "Machines and Objects Conditional Objects" presented by Pierre Restany anticipates the climate that will be Arte Povera. In New York, he experienced the Pop climate and his meeting with Yoko Ono, Jonas Mekas, Andy Warhol and P. Adams Sitney gave rise to a large production of experimental films shown in the major art centres (Centre Pompidou, Tate Modern, Venice Biennale). With Ben Vautier he created the first Italian Fluxus Concert. The combination of art and life is the basis of Nespolo's expressiveness and leads him to broaden his creative scope in disparate and eclectic areas where his love for the applied arts is alive. In 2019, the University of Turin awarded him an Honorary Degree in Philosophy. He has exhibited in galleries and museums in Italy and all around the world.





Nespolo

FIORI E NOTE GRANDI

FIORI E NOTE ART XL

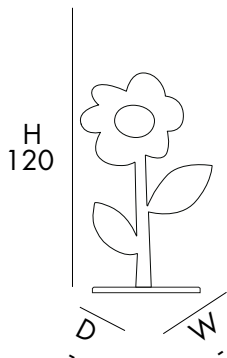

15 Kg

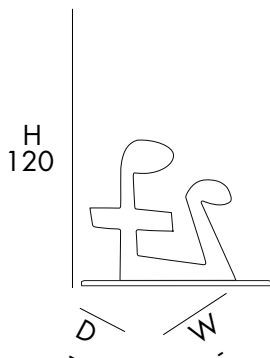

D - cm
H 120 cm
W - cm



COMPLEMENTO D'ARREDO

- INDOOR/OUTDOOR
- A FORMA DI FIORE O NOTA MUSICALE
- REALIZZATO IN PMMA
- CREATIVITÀ GRAFICA BY UGO NESPOLO

FURNISHING ACCESSORY

- INDOOR/OUTDOOR
- FLOWER OR MUSICAL NOTE SHAPE
- MADE IN PMMA
- GRAPHIC CREATIVITY BY UGO NESPOLO

ACCESSOIRE D'AMEUBLEMENT

- INDOOR/OUTDOOR
- EN FORME DE FLEUR OU DE NOTE DE MUSIQUE
- FABRIQUÉ EN PMMA
- CRÉATIVITÉ GRAPHIQUE PAR UGO NESPOLO

ACCESORIO DE MOBILIARIO

- INDOOR/OUTDOOR
- EN FORMA DE FLOR O NOTA MUSICAL
- REALIZADO EN PMMA REALIZADO EN PMMA
- CREATIVIDAD GRÁFICA DE UGO NESPOLO





Nespolo

QUADRO 86 ART

AR1927/ART

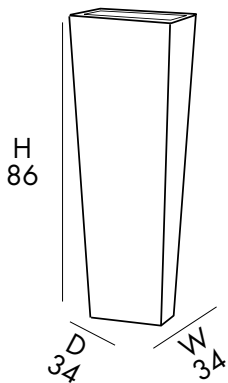

4 Kg



D 60 cm
H 90 cm
W 60 cm



COMPLEMENTO D'ARREDO

- INDOOR/OUTDOOR
- REALIZZATO IN POLIETILENE COLORATO IN MASSA
- WRAPPING (APPLICAZIONE DI SPECIALI PELLICOLE ADESIVE SUL PRODOTTO)
- CREATIVITÀ GRAFICA BY UGO NESPOLO
- CAPIENZA 23 LT



FURNISHING ACCESSORY

- INDOOR/OUTDOOR
- MADE IN HD MASS COLOURED POLYETHYLENE
- WRAPPING (APPLICATION OF SPECIAL ADHESIVE FILMS ON THE PRODUCT)
- GRAPHIC CREATIVITY BY UGO NESPOLO
- CAPACITY 23 LT

ACCESSOIRE D'AMEUBLEMENT

- INDOOR/OUTDOOR
- FABRIQUÉ EN POLYÉTHYLÈNE COLORÉE DANS LA MASSE
- WRAPPING (APPLICATION DE FILMS ADHÉSIFS SPÉCIAUX SUR LE PRODUIT)
- CRÉATIVITÉ GRAPHIQUE PAR UGO NESPOLO
- CAPACITÉ 23 LT



ACCESORIO DE MOBILIARIO

- INDOOR/OUTDOOR
- REALIZADA EN POLIETILENO COLOREADO A GRANEL EN MASE
- WRAPPING (APLICACIÓN DE PELÍCULAS ADHESIVAS ESPECIALES SOBRE EL PRODUCTO)
- CREATIVIDAD GRÁFICA DE UGO NESPOLO
- CAPACIDAD 23 LT





Nespolo

QUADRO 102 ART

DP1926/ART

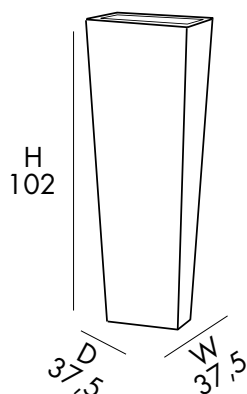

5,5 Kg



D 60 cm
H 120 cm
W 60 cm



COMPLEMENTO D'ARREDO

- INDOOR/OUTDOOR
- REALIZZATO IN POLIETILENE COLORATO IN MASSA
- WRAPPING (APPLICAZIONE DI SPECIALI PELLICOLE ADESIVE SUL PRODOTTO)
- CREATIVITÀ GRAFICA BY UGO NESPOLO
- CAPIENZA 40 LT



FURNISHING ACCESSORY

- INDOOR/OUTDOOR
- MADE IN HD MASS COLOURED POLYETHYLENE
- WRAPPING (APPLICATION OF SPECIAL ADHESIVE FILMS ON THE PRODUCT)
- GRAPHIC CREATIVITY BY UGO NESPOLO
- CAPACITY 40 LT

ACCESSOIRE D'AMEUBLEMENT

- INDOOR/OUTDOOR
- FABRIQUÉ EN POLYÉTHYLÈNE COLORÉE DANS LA MASSE
- WRAPPING (APPLICATION DE FILMS ADHÉSIFS SPÉCIAUX SUR LE PRODUIT)
- CRÉATIVITÉ GRAPHIQUE PAR UGO NESPOLO
- CAPACITÉ 40 LT



ACCESORIO DE MOBILIARIO

- INDOOR/OUTDOOR
- REALIZADA EN POLIETILENO COLOREADO A GRANEL EN MASE
- WRAPPING (APLICACIÓN DE PELÍCULAS ADHESIVAS ESPECIALES SOBRE EL PRODUCTO)
- CREATIVIDAD GRÁFICA DE UGO NESPOLO
- CAPACIDAD 40 LT





Nespolo

POT S ART

ART1656/ART

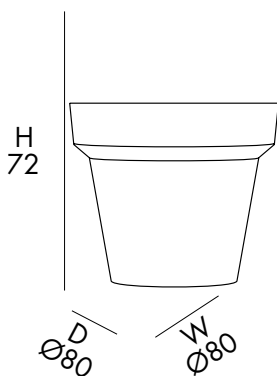

5,5 Kg



D 80 cm
H 120 cm
W 80 cm



COMPLEMENTO D'ARREDO

- INDOOR/OUTDOOR
- REALIZZATO IN POLIETILENE COLORATO IN MASSA
- WRAPPING (APPLICAZIONE DI SPECIALI PELLICOLE ADESIVE SUL PRODOTTO)
- CREATIVITÀ GRAFICA BY UGO NESPOLO
- CAPIENZA 1.260 LT



FURNISHING ACCESSORY

- INDOOR/OUTDOOR
- MADE IN HD MASS COLOURED POLYETHYLENE
- WRAPPING (APPLICATION OF SPECIAL ADHESIVE FILMS ON THE PRODUCT)
- GRAPHIC CREATIVITY BY UGO NESPOLO
- CAPACITY 1.260 LT

ACCESSOIRE D'AMEUBLEMENT

- INDOOR/OUTDOOR
- FABRIQUÉ EN POLYÉTHYLÈNE COLORÉE DANS LA MASSE
- WRAPPING (APPLICATION DE FILMS ADHÉSIFS SPÉCIAUX SUR LE PRODUIT)
- CRÉATIVITÉ GRAPHIQUE PAR UGO NESPOLO
- CAPACITÉ 1.260 LT



ACCESORIO DE MOBILIARIO

- INDOOR/OUTDOOR
- REALIZADA EN POLIETILENO COLOREADO A GRANEL EN MASE
- WRAPPING (APLICACIÓN DE PELÍCULAS ADHESIVAS ESPECIALES SOBRE EL PRODUCTO)
- CREATIVIDAD GRÁFICA DE UGO NESPOLO
- CAPACIDAD 1.260 LT



CERTIFICAZIONI CERTIFICATION

MATERIALI ATOSSICI



POLIETILENE
-60°C +80°C



ALLUMINIO



MARCATURE CE

IP68

Resistenza a polvere e liquidi
Resistenza a raggi UV
Resistenza alla pioggia

ISO 14001 : 2015 Sistema di gestione ambientale

ISO/TS16949 : 2009 Sistema di gestione della qualità

BS OHSAS 18001 : 2007 SGSSL

100% MADE IN ITALY

ATOXIC MATERIALS - 100% RECYCLABLE



POLIETHYLENE
-60°C +80°C



ALUMINIUM



CE MARKING

IP68

Resistance to dust and liquids
Resistance to UV rays
Resistance to rain

ISO 14001 : 2015 Environmental management system

ISO/TS16949 : 2009 Quality management systems

BS OHSAS 18001 : 2007 SGSSL

100% MADE IN ITALY

CERTIFICAZIONI

CERTIFICATION



Copia della targhetta di marcatura:

La grafica sottostante può essere solo una bozza. L'uso dei marchi di certificazione su un prodotto deve essere autorizzato dalle rispettive BCN proprietarie di tali marchi.

Posizione: Incollare sull'involucro.

Osservazione:

L'altezza delle lettere non è inferiore a 2 mm; l'altezza del simbolo del cestino non è inferiore a 7 mm, gli altri simboli non sono inferiori a 5 mm.

Secondo le direttive UE che sono state allineate al nuovo quadro legislativo europeo (NLF), il nome e l'indirizzo del produttore e dell'importatore devono essere apposti sul prodotto o, se ciò non è possibile, sull'imballaggio o in un documento di accompagnamento del prodotto prima che questo sia immesso sul mercato UE.



Copy of marking plate:



The artwork below may be only a draft. The use of certification marks on a product must be authorized by the respective NCBS that own these marks.

Location: Stick on the enclosure.

Remark:

The height of the letters is not less than 2 mm; the height of the recycle bin symbol is not less than 7 mm, other symbols are not less than 5 mm.

According to the EU directives which have been aligned with EU NLF (new legislative framework), both manufacturer and importer's name and address shall be affixed on the product or, where that is not possible, on its packaging or in a document accompanying the product before the product is placed on the EU market.

TYP LT1928B	IP67	
LED 0.35W		
(3.7V --- 4800mAh rechargeable Li-ion battery.		CE
Charding: SELV 5V --- 1A		
or by solar		
Importer: xxxx		
Andress: xxxx		

CONDIZIONI GENERALI DI VENDITA

GENERAL TERMS OF SALE



Le presenti Condizioni Generali di Vendita si applicano a tutti gli ordini accettati da Officine Metallurgiche Cornaglia SPA. Condizioni difformi da quelle qui contenute saranno valide solo se redatte in forma scritta.

Nessun ordine sarà considerato accettato sino a quando lo stesso non sarà confermato mediante conferma emessa dal fornitore.

I rischi legati alla merce in viaggio sono a totale carico del committente pur nella condizione di vendita "porto franco".

Eventuali reclami sulle quantità dovranno essere contestati allo spedizioniere all'atto del ricevimento della merce, che siano presenti o meno tracce d'effrazione sull'imballo.

Ogni reclamo sulla qualità della merce dovrà esserci comunicato entro e non oltre otto giorni dal ricevimento della merce, mediante e-mail.

Verrà sostituito quel materiale che, reso franco nostro domicilio, venga da noi ritenuto difettoso.

Il reso del materiale deve essere in ogni caso espressamente autorizzato ed il reclamo deve essere inviato entro i termini di legge dalla data della fattura di vendita.

La garanzia è limitata al costo dei particolari difettosi, con esclusione di qualsiasi indennizzo per i danni subito in conseguenza del reclamo. Tutti i prodotti hanno la garanzia di legge - previo corretto uso e manutenzione degli stessi.

Sono esclusi materiali di consumo, quali, cartucce - guarnizioni - accessori - se già utilizzati. I prezzi si intendono per merce resa franco nostro magazzino.

L'azienda si riserva la facoltà di modificare i prezzi qualora sopravvengano variazioni nei costi di produzione. Il pagamento deve avvenire nei termini e forme pattuite e per l'intero importo della fattura; non sono pertanto ammessi sconti o detrazioni a qualsivoglia titolo.

Le immagini e i riferimenti in questo catalogo non sono vincolanti e devono essere considerati a puro titolo indicativo.

Conformità al campione non deve intendersi in senso tassativo, poiché sussistono margini di tolleranza dovuti a variazioni (colori-mate-riali-misure-litri) causate da fattori ambientali (luce-umidità-ecc.).

Alcuni accessori presenti nelle immagini non sono prodotti dalla ditta e possono subire variazioni. È vietata qualsiasi riproduzione, anche parziale, del presente catalogo senza preventiva autorizzazione di Officine Metallurgiche Cornaglia SPA.

Officine Metallurgiche Cornaglia SPA declina ogni responsabilità per eventuali errori od omissioni relativi a dati ed immagini in esso contenute. L'azienda si riserva la facoltà di modificare, in qualunque momento e senza preavviso alcuno, le caratteristiche tecniche, dimensionali e di capienza nel presente manuale, al fine di migliorare il prodotto senza pregiudicare le caratteristiche essenziali. Per qualsiasi controversia il Foro competente sarà quello di Torino.



These general terms of sale apply to all the orders accepted from Officine Metallurgiche Cornaglia SPA. Different conditions are considered valid only if submitted in written form.

The order will be considered as accepted only after the supplier's confirmation.

Delivery risks are totally at customer's charge, even if the sales conditions are "ex works". Any complaint against the good's quantity must be notified to the forwarder at the moment of the good's reception, if the packaging appears to be forced or not.

Every complaint against the good's quality must be notified within eight days from the good's reception, by fax or e-mail.

Only those parts which are considered faulty from us, will be replaced. Those parts must be sent to our warehouse ex works.

The material may be sent back to our warehouse only after written authorization of the supplier and the complaint must be sent within the legal conditions from the date of the sales invoice.

Warranty only covers the cost of the faulty parts, excluding any further indemnity for damages caused by the complaint.

All products are guaranteed by law - after proper use and maintenance.

Consumables such as cartridges - gaskets - accessories - (if already used) are excluded.

Our prices are valid for deliveries ex works. We reserve the right to modify the prices, if the manufacturing costs vary.

Payment must be made under the agreed form and terms for the total amount of the invoice; deductions or discounts for any reason are not allowed.

Our parts are original, the pictures references of the catalogue have to be considered just as an indication and are not binding.

Compliance with the sample should not be understood in the exhaustive meaning, as there are tolerances due to changes (colors - materials - measurements-liters) caused by environmental factors (light - moisture - etc.).

Any reproduction even partial, of this catalogue without authorization of Officine Metallurgiche Cornaglia SPA is forbidden.

Officine Metallurgiche Cornaglia SPA is not responsible for mistakes and omissions relating data and pictures.

Our company reserves the right to modify at anytime, without prior notice, the technical, dimensional and capacity features in this manual; in order to improve the product without affecting the basic features.

For any dispute the court will be in Turin.

CONDITIONS GÉNÉRALES DE VENTE

CONDICIONES GENERALES DE VENTA



Ces conditions générales de vente s'appliquent à toutes les commandes acceptées par Plart Design sri, société soumise à la direction et à la coordination de Comaglia Group S.p.A.

Conditions différentes de celles contenues dans ce document ne sont valables que par écrit.

Aucune commande ne sera considérée comme acceptée jusqu'à la confirmation émise par le fournisseur.

Les risques liés aux marchandises en transit sont à la charge de l'acheteur même dans la condition de vente "franco de port".

Toute plainte concernant le montant doit être immédiatement notée à l'expéditeur lors de la réception des marchandises, qui montrent des traces d'effacement sur l'emballage ou pas

Toute réclamation sur la qualité des produits doit être notifiée au plus tard huit jours à compter de la réception des marchandises, par fax ou par e-mail.

Le matériel livré franco de port, chez notre entrepôt et considéré comme défectueux, sera remplacé. Le retour des produits doit être expressément autorisée dans chaque cas et la plainte doit être envoyée dans les délais à compter de la facture de vente.

La garantie est limitée au coût des pièces défectueuses, avec exclusion de toute indemnisation pour les dommages subis à la suite de la plainte

Tous les produits ont une garantie selon la loi - après une utilisation et un entretien appropriés.

Les consommables tels que les cartouches - joints d'étanchéité - accessoires - sont exclus si déjà utilisés.

Les prix indiqués sont pour les produits livrés franco de port, nous nous réservons le droit de modifier les prix si des changements des coûts de production surviennent.

*Le paiement doit être envoyé en conformité avec les conditions et les formes convenues et pour le montant total de la facture; rabais ou des déductions ne sont donc pas autorisés pour n'importe quelle raison. Nos articles sont originales et les images et les références dans ce catalogue ne sont pas contraignantes et doivent être considérés comme purement indicatifs.

Conformité avec l'échantillon ne doit pas être comprise dans le sens exhaustive, car il y a des tolérances dues aux changements (couleurs - mesures - matériaux - litres), causés par des facteurs environnementaux (lumière - humidité - etc.) Il est interdit de reproduire, même partiellement ce catalogue sans l'autorisation de la société PART DESIGN.

PART DESIGN n'accepte aucune responsabilité pour les erreurs ou omissions liés à données et images contenues dans ce document.

Notre entreprise se réserve le droit de modifier sans obligation de préavis, les caractéristiques techniques, dimensionnelles et de capacité de ce manuel, afin d'améliorer le produit sans en modifier les caractéristiques de base.

Pour tout conflit le tribunal de compétence sera à Turin.



Las presentes condiciones generales de venta se aplican a todos los pedidos aceptados por Plart Design sil, empresa sujeta a la Dirección y Coordinación de Comaglia Group S.p.A.

Condiciones distintas de las contenidas en el presente documento sólo serán válidas si compiladas por escrito.

Ningún pedido se considerará aceptado hasta la confirmación emitida por el proveedor. Los riesgos asociados con las mercancías en tránsito, son responsabilidad exclusiva del comprador, también en la condición de venta "con gastos de expedición a nuestro cargo".

Cualquier queja sobre la cantidad debe ser notificada inmediatamente al transportador a la recepción de la mercancía, tanto en el caso que hay rastros de robo en el embalaje o bien no. Cualquier queja sobre la calidad de los bienes debe ser notificada a más tardar ocho días a partir de la recepción de las mercancías, por fax o correo electrónico. El material enviado a nuestro establecimiento con coste de transporte a cargo del cliente y considerado defectuoso será reemplazado. La devolución del material deberá ser expresamente autorizada en cada caso y la queja debe ser enviada dentro de los términos de entrega a partir de la fecha de la factura de venta.

La garantía se limita al costo de las piezas defectuosas, excluyendo cualquier indemnización por daños y perjuicios sufridos como consecuencia de la denuncia. Todos los productos están garantizados por la ley, después del uso adecuado y el mantenimiento de los mismos los consumibles, como cartuchos, juntas, accesorios, si ya se utilizan, están excluidos.

Los precios indicados son por los bienes entregados con gastos de expedición a cargo del cliente, nos reservamos el derecho de cambiar los precios si cambios en los costos de producción sobrevienen. El pago debe ser efectuado en los términos y formas acordadas y por el importe total de la factura; por tanto, no se permiten deducciones o rebajas por cualquier motivo. Nuestros artículos son originales y las imágenes y referencias de este catálogo no son vinculantes y deben ser considerados puramente indicativas. La congruencia con el dibujo no debe entenderse en el sentido exhaustivo, ya que hay tolerancias debidas a los cambios (materiales colores - medidas litros), causadas por factores ambientales (luz - humedad - etc.). Toda reproducción, incluso parcial, de este catálogo sin previa autorización de PLART DESIGN está prohibida.

PLART DESIGN no se hace responsable de los errores o omisiones relacionadas con los datos y las imágenes contenidas en el presente documento. Nuestra empresa se reserva el derecho de modificar en cualquier momento y sin previo aviso las características técnicas.

dimensionales y de capacidad de este manual, con el fin de mejorar el producto sin afectar a las características básicas.

Para cualquier controversia la jurisdicción competente será en Turin.

ARKEMA DESIGN - DISTRETTO DELL'ECODESIGN
Str. Buttigliera 71 - 14019 - Villanova d'Asti (AT) - ITALIA
P.IVA 11019980017

ITALIA: +39 0141 944821
commercialeitalia@arkemadesign.com

ESTERO: +39 0141944820
export@arkemadesign.com



www.arkemadesign.com