

Home Harmonies



ARIT

IL CUORE DEL LEGNO

AAR REDAMENTI
iT ALIA

L'azienda • *The Factory*



#WEARIT
NOI SIAMO ITALIA

IL NOSTRO SIMBOLO - OUR SYMBOL



Il simbolo del nostro marchio non rappresenta solamente l'iniziale del nostro nome.

La nostra A:

rappresenta la casa che Arredamenti Italia si pone come compito di decorare, proponendo a tutte le famiglie prodotti utili e funzionale per comporre la casa dei loro sogni.

La nostra A:

rappresenta una casetta stilizzata, semplice come le forme dei nostri prodotti ma con pareti solide e robuste come la struttura dei prodotti che realizziamo.

La nostra A:

Diamo il nostro meglio ogni giorno per creare prodotti che abbiano un livello qualitativo di classe A

La nostra A:

quella che spesso si vede anche nel concept dei nostri prodotti:



The symbol of our brand is not just the initial of our name...

Our A:

it represents the home that Arredamenti Italia sets as its task of decorating, proposing to all families useful and functional products to compose the house of their dreams.

Our A:

it represents a stylized house, simple as the shapes of our products but with solid and sturdy walls like the structure of the products we make.

Our A:

we do our best every day in order to create products which have a class A like quality level.

Our A:

what is often seen in the concept of our products:

La storia di: Arredamenti Italia

Chi siamo

Arredamenti Italia è un'affermata azienda sul mercato nazionale in ambito dell'arredamento che fin dalla sua nascita ha saputo far tesoro della tradizione artigianale con le sue regole tramandate ora alla terza generazione.

Le origini

Le origini di Arredamenti Italia trovano collocazione nella laboriosa Valle Sabbia, terra di lavoratori in provincia di Brescia. Da qui il signor Eugenio Caccagni intende sviluppare il suo spirito imprenditoriale lavorando il legno, dapprima come terzista per una grande azienda locale, sviluppandosi poi negli anni e proponendo i propri prodotti sul mercato con il marchio Arredamenti Italia. Dal 2017 l'azienda ha cambiato il marchio dei prodotti in Arit.



Company staff end of '50 - Organico aziendale fine anni '50

Lo sviluppo

Grazie ad una mentalità sempre rivolta al futuro e al miglioramento, grazie ad investimenti mirati la società è cresciuta negli anni raggiungendo una distribuzione quanto più estesa sul suolo Italia. Grazie all'ingresso di un'apparato manageriale l'estensione si è protratta al di fuori del suolo italiano, raggiungendo luoghi lontani con la consapevolezza delle proprie origini.

La lavorazione

La produzione Arredamenti Italia è frutto di accurato lavoro e costante impegno di un compatto gruppo aziendale che, pur mantenendosi legato alle consuetudini artigiane, affianca le più sofisticate tecnologie della lavorazione del legno con aggiornati investimenti mirando al raggiungimento dei più alti standard qualitativi. I prodotti Arredamenti Italia sono totalmente ed esclusivamente creati nella sede dell'azienda: Bione, Brescia. Il profondo amore nutrito per il legno impone di rispettare l'ambiente. La collezione Arredamenti Italia è realizzata con materiali di alta qualità e processi di produzione accurati, la cura dei particolari e l'alta qualità delle lavorazioni sono ben visibili nella precisione delle finiture. Le tecnologie ed i materiali innovativi combinano benefici funzionali con durata nel tempo e facilità di manutenzione; la fase finale della produzione testa i prodotti nelle condizioni più critiche prima di essere inoltrati sul mercato.

Mission

Lavoriamo il legno da sempre e, da sempre, sappiamo esaltarne tutte le qualità e la bellezza. Il nostro Prodotto nasce da mani artigiane che, piegando questo nobile materiale alla loro sapiente volontà, sanno assecondare le esigenze del design più attuale.

Vision

La tradizione artigiana moderna, questo vogliamo immettere nel nostro prodotto. La percezione di un prodotto dalle fattezze artigianali derivato dalle tecnologie attuali per poter soddisfare i bisogni sempre più moderni. Non abbiamo la presunzione di risolvere i problemi delle famiglie nelle faccende domestiche, a noi però il piacere ogni giorno di renderli più confortevoli con i nostri prodotti.

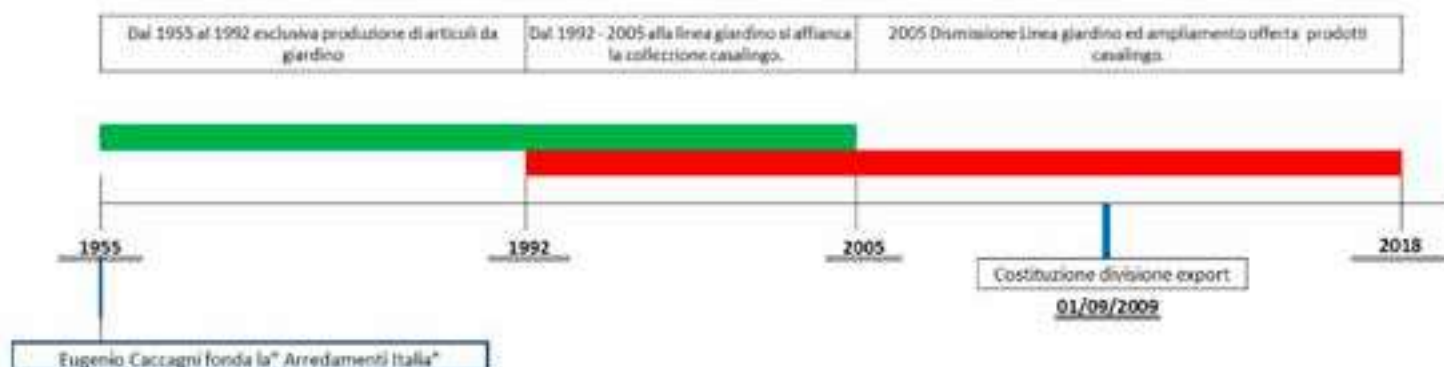

The story of: Arredamenti Italia

Who we are

Arredamenti Italia is a company established in the domestic market in the field of furniture, that since the beginning has been able to profit from the traditional craftsmanship, with its rules passed now to the third generation.

The origins

Arredamenti Italia got its roots in the laborious Sabbia Valley, land of workers in the province of Brescia. Since the beginning Mr. Eugenio Caccagni develops his entrepreneurial spirit working wood, first as a subcontractor for a big local company, developing later in the years and offering their products on the market under the brand Arredamenti Italia. Starting from 2017 the company changed the product's brand in Arit.



Current executive staff

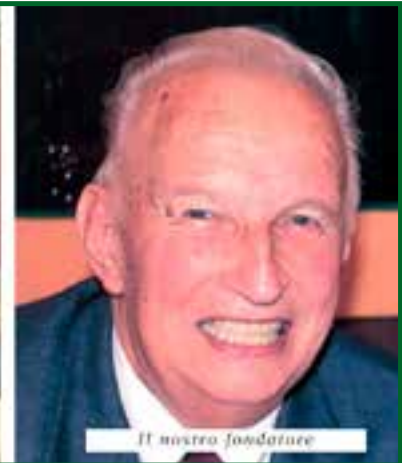

Our founder

Development

With a mentality always focused on improvement into the future, thanks to targeted investments the company has grown over the years, reaching a wider distribution than in Italy. Thanks to the input of managerial apparatus the extension lasted beyond Italian soil, reaching far away places with great awareness of own origins.

Processing

The Arredamenti Italia production is the result of careful work and constant commitment of a compact group of companies which, on the one side remains linked to the custom crafts, on the other, combines the most sophisticated technologies of woodworking with updated investment aiming to achieve the highest quality standards. Arit products are totally and exclusively created in the company's headquarters: Bione, Brescia. The deep love for the wood requires respect for the environment. Arredamenti Italia collection is made with high quality materials and accurate manufacturing processes, the attention to detail and the high quality of workmanship are clearly visible in the accuracy of the finishes. The technologies and innovative materials combine functional benefits with durability and ease of maintenance; the final stage of production tests products in the harshest conditions before sending them to the market.

Mission

We always work the wood and always get out the best in terms of quality and beauty. Our product was born from craftsmen who, shaping this noble material according to their wise will know how to meet the needs of the most current design.

Vision

We want to introduce into our product the modern artisan tradition. The perception of a product from craft features derived from current technologies to be able to meet the newest and more modern needs. We don't have the pretension to solve the problems of the families, but every day we have the pleasure to make them more comfortable with our products.

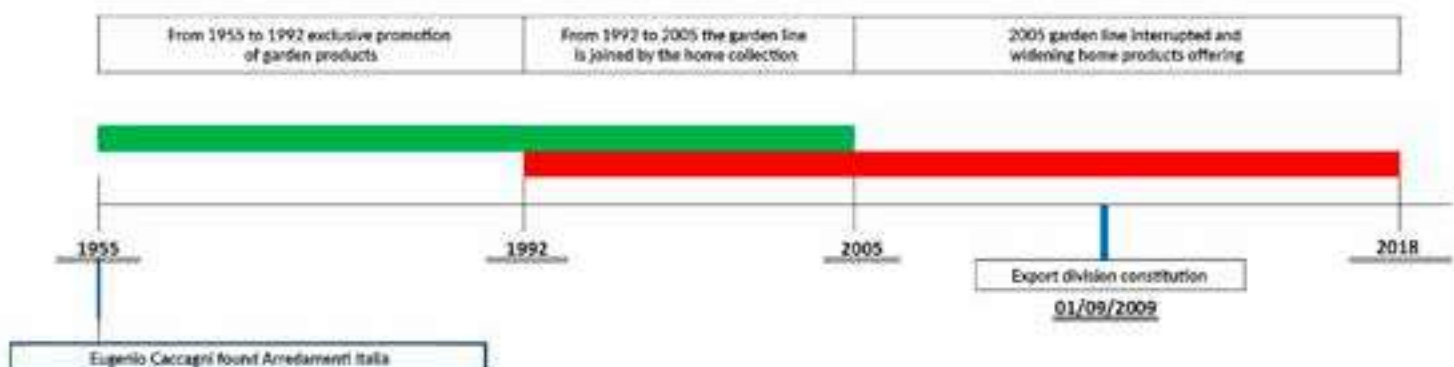



L'azienda utilizza solo legno proveniente da aree geografiche certificate e da boschi la cui riforestazione è garantita e controllata da normative locali e verificata dai corpi forestali. Le foreste vengono quindi regolarmente rigenerate.

The company only uses wood from certified geographical areas and from forests where reforestation is guaranteed and controlled by local regulations and verified by the forestry organisations. The forests are therefore regularly regenerated.

ENERGIA DAL SOLE

Nel 2015 l'azienda ha investito in pannelli fotovoltaici, coprendo il 25% del suo fabbisogno energetico.

SUN ENERGY

In 2015 the company invested in a photovoltaic system, covering the 25% of energy needs.



RISCALDAMENTO ECOLOGICO

Nel processo produttivo, tutti gli scarti di legno vengono recuperati, nei silo, e riutilizzati come combustibile per il riscaldamento di stabilimenti e uffici. In questo modo il riscaldamento aziendale è ecologico, non utilizzando ne gas ne metano.

ECOLOGICAL HEATING

All the wood offcuts from the production process are recovered, into a silo, and reused as fuel for heating factories and offices, In this way the company heating is ecological, by not using gas or methane.

MATERIE PRIME - RAW MATERIALS

LEGNO - WOOD

Tutto il legno utilizzato per la realizzazione dei nostri prodotti proviene da segherie certificate FSC

All the wood used to realize our products come from sawmill FSC certified



CARTONI - PACKAGING

I cartoni utilizzati sono riciclabili al 100%, inoltre sono biodegradabili in quanto costituiti per più del 50% da materia organica.

The cartons used are 100% recyclable, they are also biodegradable as they consist of more than 50% by organic matter.

VERNICI - PAINTS

Le vernici utilizzate sono conformi alla normativa REACH, ed esenti da metalli pesanti in relazione alla normativa Europea EN71-3:2013

The paints comply with the REACH regulations, and are free from heavy metals in relation to the European EN71-3: 2013 standard.

PERCHÉ SCEGLIERE ARIT? - WHY CHOOSE ARIT?

100% MADE IN ITALY

Tutti i nostri prodotti sono interamente progettati e realizzati in Italia.

QUALITÀ

Tecnologia e abilità artigiana per curare tutti i dettagli del prodotto, selezionando le migliori materie prime.

DURATA

Tutti i nostri prodotti sono studiati per durare a lungo nel tempo.

FUNZIONALITÀ

Tutti i nostri prodotti sono progettati per dare la massima utilità quando aperti, una volta chiusi scomparire negli angoli della tua casa.

SERVIZIO

Servizio clienti sempre a disposizione. Prodotti sempre disponibili grazie ad un versatile sistema produttivo.

FLESSIBILITÀ

Abilità nell'assecondare le esigenze del cliente grazie ad un versatile sistema produttivo.

SERVIZIO LOGISTICO

Un efficiente sistema MRP ci permette di garantire consegne veloci per soddisfare svariate richieste.

100% MADE IN ITALY

All our products are entirely projected and realized in Italy.

QUALITY

Technology and artisan ability in order to care to all the product details, selecting the best raw materials.

DURATION

All our products are studied to be used for a long time.

FUNCTIONALITY

All our products are projected to have the best utility when opened, and disappear easily into the small corners of your home when folded.

SERVICE

Customer care always at your disposal. Products always ready thanks to a versatile producing system.

FLEXIBILITY

Ability to satisfy the customer needs, thanks to a versatile producing system.

LOGISTIC SERVICE

An efficient MRP system allows us to grant fast deliveries, in order to satisfy the requests coming from each kind of customer.

CUCINA

KITCHEN



ARIT

AREA ATTREZZATA

- Struttura in faggio massiccio
- Ampio piano di lavoro in listellare di faggio
- Due piani d'appoggio laterali apribili in listellare di faggio
- Cestelli in metallo verniciato a polveri
- Due capienti cassetti
- Portabottiglie orizzontale
- Ruote piroettanti e bloccanti in gomma antitraccia

KITCHEN AREA

- Solid beechwood structure
- Wide working plane made in solid beechwood
- Equipped with 2 opening lateral planes made in lamellate of beechwood
- 2 sliding powder-coated metal baskets
- 2 wide drawers made in solid beechwood
- Little cellar in the middle
- Lockable revolving wheels made in rubber non-scratch

Santiago cod. 582

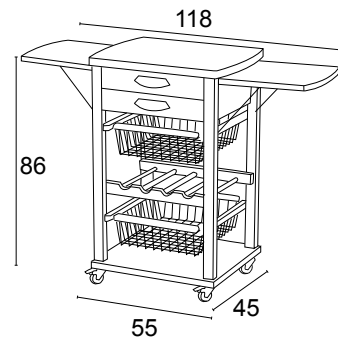

ARIT



Gastone cod. 585

AREA CUCINA

- Struttura in faggio massiccio
- Tagliere apribile in listellare di faggio
- Cestelli in metallo verniciato a polveri
- Ampio cassetto massiccio
- Ruote piroettanti e bloccanti in gomma antiraccia

KITCHEN AREA

- Solid beechwood structure
- Working plan made in solid beechwood, openable from 50 cm to 100 cm.
- Sliding powder-coated metal baskets
- Wide drawer and knives holder made in beechwood
- Lockable revolving wheels made in rubber non-scratch





laccato bianco - white lacquered



ciliegio - cherry wood

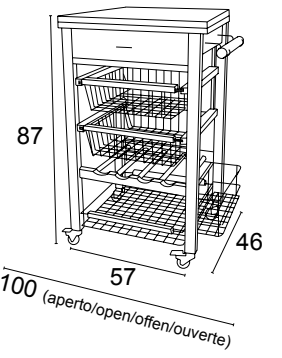

ARIT

CARRELLO CUCINA

- Struttura in faggio massiccio
- Tagliere apribile in listellare di faggio
- Cestelli scorrevoli in metallo verniciato a polveri
- Ruote piroettanti antitraccia

KITCHEN TROLLEY

- Solid beechwood structure
- Working plan made in solid beechwood, openable from 48 cm to 96 cm.
- Sliding powder-coated metal baskets
- Revolving wheels made in rubber non-scratch

Gastoncino

cod. 518



ARIT



laccato bianco - white lacquered



ciliegio - cherry wood

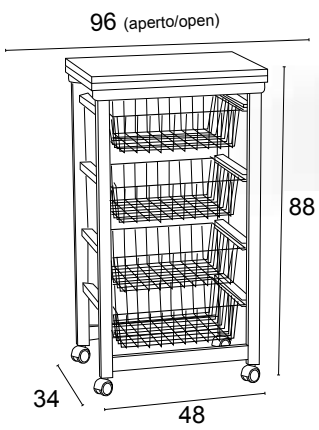

PORTA VERDURA

Ginger cod. 500

VEGETABLES BASKETS

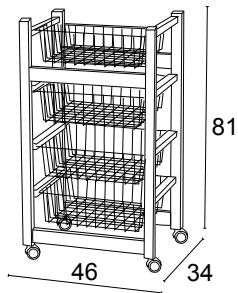

Ginger + Drink

VASSOIO

Drink cod. 510

TRAY



PORTA VERDURA CON PIANO

- Struttura in faggio massiccio
- Ripiano in truciolare nobilitato
- Cestelli scorrevoli in metallo verniciato a polveri
- Ruote piroettanti in gomma antitraccia

GingerOne cod. 515

KITCHEN TROLLEY

- Solid beechwood structure
- Upper plan made in noble chipboard
- 4 Sliding powder-coated metal baskets
- Revolving wheels made in rubber non-scratch

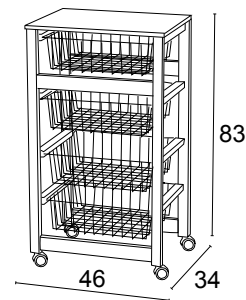

laccato bianco - white laquered



ciliegio - cherry wood



ARIT

Gustavo cod. 517

CARRELLO CUCINA CON PIANO 6 CESTELLI

- Struttura in faggio massiccio
- Ripiano in truciolare nobilitato
- Cestelli scorrevoli in metallo verniciato a polveri
- Ruote piroettanti in gomma antitraccia



ciliegio - cherry wood

KITCHEN TROLLEY 6 BASKETS

- Solid beechwood structure
- Upper plan made in noble chipboard
- Sliding powder-coated metal baskets
- Equipped with 1 special metal basket studied for bottles
- Revolving wheels made in rubber non-scratch



laccato bianco - white laquered

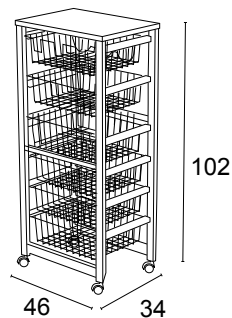

GustavOtto

cod. 519

CARRELLO CUCINA
CON PIANO 8 CESTELLI

KITCHEN TROLLEY & BASKET



Cestello portabottiglie - Special basket bottles holder



laccato bianco - white laquered



ciliegio - cherry wood

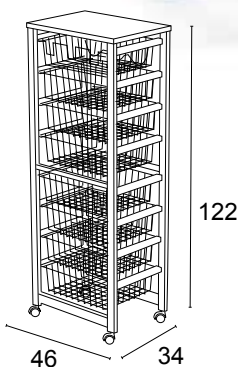

ARIT

CEPPO CANTINA

- Struttura in faggio massiccio
- Tagliere in listellare di faggio
- Cestelli in metallo verniciato a polveri
- Ampio cassetto massiccio
- Ruote piroettanti in gomma antitraccia

KITCHEN AREA

- Solid beechwood structure
- Wide upper working plan
- Sliding powder-coated metal baskets
- Wide drawer and bottles rack made in beechwood
- Revolving wheels made in rubber non-scratch

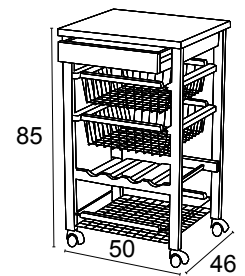

Arturo

 cod. 540

laccato bianco - white laquered



ciliegio - cherry wood

Birellone

cod. 547

12 POSTI
PLACES

CANTINETTA MODULARE

- Completamente in faggio massiccio
- Semplice sistema di assemblaggio
- Piedini alla base per appoggio e sistema modulare

KITCHEN AREA

- Solid beechwood structure
- Rubber feet at the base
- Simple modular system
- 12 places for bottles each module

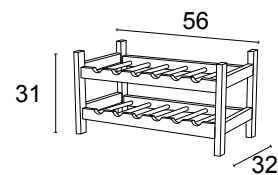
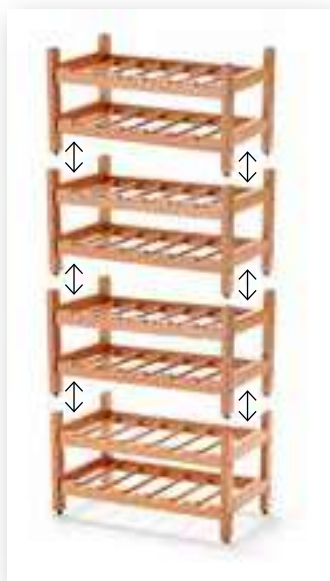

CANTINETTA

- Completamente in faggio massiccio
- Piedini in gomma alla base

Ardesia cod. 545

LITTLE CELLAR

- Solid beechwood structure
- Rubber feet at the base
- 30 places for bottles

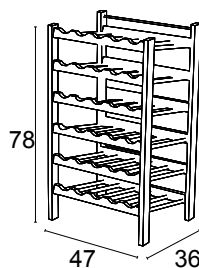

CARRELLO CUCINA

- Struttura in faggio massiccio
- Tagliere in listellare di faggio
- Cestelli in metallo verniciato a polveri
- Ampio cassetto massiccio
- Ruote piroettanti in gomma antitraccia

Raikon

cod. 530

KITCHEN AREA

- Solid beechwood structure
- Working plan made of solid beechwood
- Sliding powder-coated metal baskets
- Wide drawer made in beechwood
- Revolving wheels made in rubber non-scratch

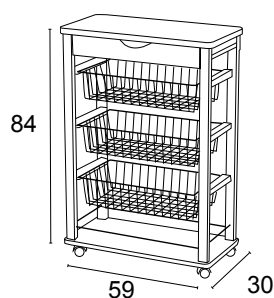

ARIT

PORTA VERDURA CON PIANO

- Struttura in faggio massiccio
- Ripiano in truciolare nobilitato
- Cestelli scorrevoli in metallo verniciato a polveri
- Ruote piroettanti in gomma antitraccia

Oliver cod. 594

KITCHEN TROLLEY

- *Solid beechwood structure*
- *Upper plan made in noble chipboard*
- *Powder-coated metal baskets*
- *Revolving wheels made in rubber non-scratch*

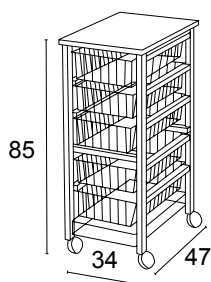

ARIT

RACCOGLITORE DI DIFFERENZIATA

- Struttura in truciolare nobilitato
- Cornici in legno massiccio
- Singola apertura delle antine
- Ruote piroettanti antitraccia alla base
- Contenitori orientabili in materiale plastico da 12 litri
- Ideale per piccoli spazi.

DIFFERENTIATED WASTE BINS

- Structure made in noble chipboard
- Frames and details made in solid beechwood
- Single opening of doors
- Revolving wheels made in rubber non-scratch
- Equipped with 2 plastic container removable (capacity 12 litres each one)
- Ideal for little spaces.



Madera 2 cod. 872



ciliegio - cherry wood



laccato bianco - white lacquered



ARIT

RACCOGLITORE DI DIFFERENZIATA

- Ideale per raccolta
carta - vetro - alluminio - plastica

Madera 4 cod. 874

DIFFERENTIATED WASTE BINS

- Ideal for collection: paper - glass - aluminium - plastic
- Equipped with 4 plastic container removable
(capacity 12 litres each one)

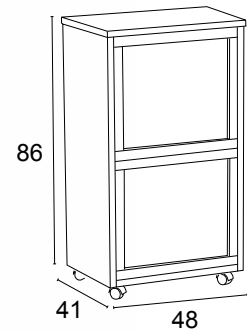

laccato bianco
white lacquered



ciliegio
cherry wood



STIRO

IRON



wenghé

laccato bianco
white lacquered



ciliegio - cherry wood

naturale - natural

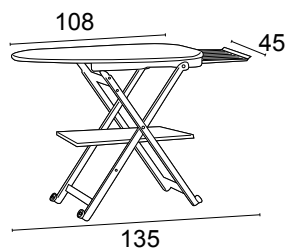

altezza regolabile in 4 posizioni
4 - positions adjustable height

TAVOLO DA STIRO REGOLABILE

- Struttura in faggio massiccio
- Regolabile in 4 altezze
- Piano in rete traforato e verniciato a polveri
- Ampia griglia portacaldaia a scomparsa
- Ruote alla base che "lavorano" in posizione chiusa
- Capiente piano portaindumenti
- Fodera esclusiva in puro cotone

ADJUSTABLE IRONING BOARD

- Solid beechwood structure
- Adjustable to 4 heights of 84 - 88 - 91 - 93 cm
- Working surface made in metal galvanised and perforated
- Wide, sliding iron holder
- Wheels made in rubber non-scratch that only work when in the closed position
- Capacious shelf for laundry
- Printed cotton ironing board cover, coated with heat resistant aluminium treatment

Stirocomodo

cod. 621



ARIT

Stirolight cod. 619

TAVOLO DA STIRO REGOLABILE

- Struttura in faggio massiccio
- Piano in rete traforato e verniciato a polveri
- Regolabile in 4 posizioni
- Ruote alla base che lavorano solo in posizione chiusa

ADJUSTABLE IRONING BOARD

- Solid beechwood structure
- Adjustable to 4 heights of 84 - 88 - 91 - 93 cm
- Working surface made in metal galvanised and perforated
- Wide, sliding iron holder
- Wheels made in rubber non-scratch that only work when in the closed position
- Printed cotton ironing board cover, coated with heat resistant aluminium treatment

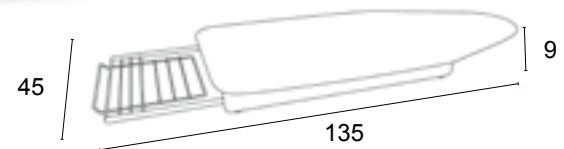
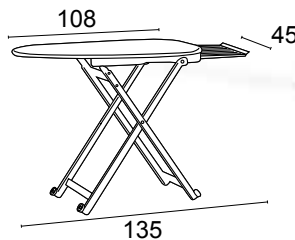

PIANO STIRO DA APPOGGIO

- Struttura in faggio massiccio
- Piano in rete traforato e verniciato a polveri
- Ampia griglia portacaldaia a scomparsa
- Piedini in gomma antiscivolo
- Dotato di custodia

IRONING BOARD FOR TABLE

- Solid beechwood structure
- Working surface made in metal galvanised and perforated
- Wide, sliding iron holder
- Rubber feet at the base to protect any surface
- Practical case to place it anywhere
- Printed cotton ironing board cover, coated with heat resistant aluminium treatment



Stiropatico cod. 636

Astir

cod. 622

TAVOLO DA STIRO

- Struttura in faggio massiccio
- Piano in rete traforato e verniciato a polveri
- Capiente piano portaindumenti
- Ampia griglia portacaldaia a scomparsa

ADJUSTABLE IRONING BOARD

- Solid beechwood structure
- Working surface made in metal galvanised and perforated
- Wide, sliding iron holder
- Capacious shelf for laundry
- Printed cotton ironing board cover, coated with heat resistant aluminium treatment

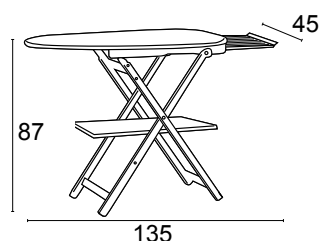

Ministyro

cod. 637

MINI STIRO PORTATILE E REGOLABILE

- Struttura in faggio massiccio
- Regolabile in 4 altezze
- Piano in rete traforato e zincato
- Fodera esclusiva in puro cotone
- Piedini in gomma antiscivolo
- Facilmente richiudibile

LITTLE PORTABLE IRONING BOARD

- Solid beechwood structure
- Working surface made in metal galvanised and perforated
- Adjustable to 4 heights of 10 - 15 - 24 - 30 cm
- Rubber feet at the base to protect any surface
- Easy closing system
- Printed cotton ironing board cover, coated with heat resistant aluminium treatment

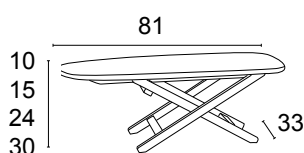

naturale - natural



ciliegio - cherry wood

ARIT

TAVOLO DA STIRO REGOLABILE

- Piano multistrato di pino fenolico
- Struttura in faggio massiccio
- Il piano più grande della sua categoria 115x54
- Sistema di regolazione del piano unico nel suo genere
- Ripiani apribili con sistema "aprifacile"
- Ampia griglia portacaldaia
- Ruote piroettanti che "lavorano" in posizione chiusa
- Chiuso sta in piedi da solo

ADJUSTABLE IRONING BOARD

- Solid beechwood structure
- One of a kind height adjustment system allows for the height to be adjusted from 86 cm to 92 cm
- Working surface made in multilayer of phenolic pinewood
- The widest working surface in its category 115 x 54 cm
- Wide, sliding iron holder
- Revolving wheels that only work when in the closed position
- Capacious shelves for laundry
- Only 19 cm when closed remains standing on its own

Bravo cod. 620

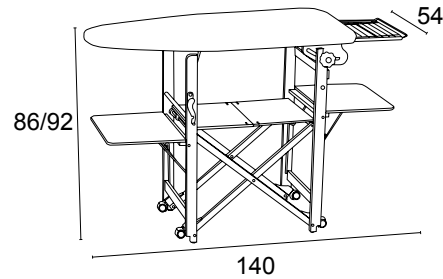

ARIT



sistema di regolazioni in più altezze
adjusting system for several heights



Stiromobile

cod. 630

MOBILE DA STIRO

- Particolari in faggio massiccio
- Struttura in truciolare nobilitato
- Piano in rete traforato e verniciato a polveri
- Singola apertura delle ante
- Ruote piroettanti
- Piedino regolabile per stabilità

IRONING STATION

- Structure made in noble chipboard
- Frames and details made in solid beechwood
- Single opening of doors
- Revolving wheels made in rubber non-scratch
- Working surface made in metal galvanised and perforated
- Adjustable foot to keep the plan in straight position





noce - walnut



laccato bianco - white laquered



naturale - natural



ciliegio - cherry wood

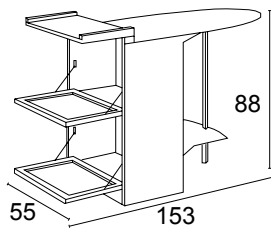
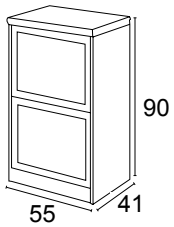

pedino regolabile per stabilità nella stiratura
foot for mayor stability in ironing

MOBILETTO STIRO

- Particolari in faggio massiccio
- Struttura in truciolare nobilitato
- Singola apertura delle ante
- Piano multistrato di pino fenolico
- Ruote piroettanti

LITTLE IRONING STATION

- Structure made in noble chipboard
- Frames and details made in solid beechwood
- Single opening of doors
- Revolving wheels made in rubber non-scratch
- Working surface made in multilayer of phenolic pinewood

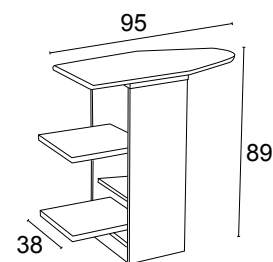
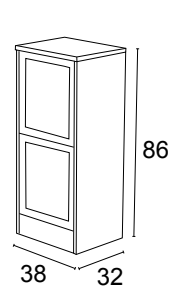

Stirosvelto

cod. 635 CHIUDIBILE / CAN BE CLOSED



Stiromaniche

cod. 625 CHIUDIBILE / IRONING ACCESSORIES FOR SLEEVES, FOLDABLE

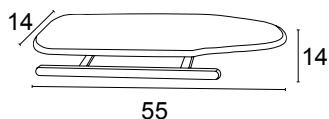

Bird

cod. 629 STIROMANICHE FISSO / IRONING ACCESSORIES FOR SLEEVES

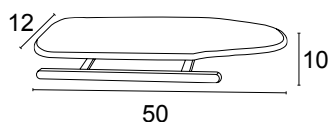

Fodera

cod. 613 PER/FOR STIRALLEGRO

cod. 623 PER/FOR BRAVO

cod. 626 PER/FOR STIROMOBILE-STIROCOMODO-ASTIR-STIROLIGHT-STIROPRACTICO

Mollettone

cod. 614 PER/FOR STIRALLEGRO

cod. 624 PER/FOR BRAVO

cod. 627 PER/FOR STIROMOBILE-STIROCOMODO-ASTIR-STIROLIGHT-STIROPRACTICO



ARIT

STENDI

CLOTHESHORSE



LO STENDILENZUOLA

- Struttura in nylon
- Aste in alluminio verniciato a polveri
- Applicabile a Gabbiano, Airone, Aquilone e Aliante
- Sviluppo di 6,5 mt di filo utile
- Altezza massima da terra cm 123

Pellikano

cod. 601

LINEN HANGING ACCESSORY

- Structure made in nylon
- Powder-coated aluminium rods
- Studied to be applied on Arredamenti Italia drying rack
- Hanging space 6,5 linear metres
- Maximum height from the floor cm 123

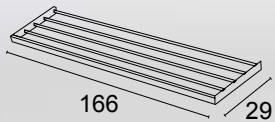

**OPTIONAL
APPLICABLE A
APPLICABLE TO
GABBIANO
ALIANTE
AIRONE
AQUILONE**



STENDIBIANCHERIA

- Struttura in legno massiccio
- Griglie indipendenti in nylon
- Aste in alluminio verniciato a polveri
- Doppia vaschetta portamollette orientabile
- Ruote piroettanti antitraccia
- 30 mt di filo utile

Gabbiano

cod. 600

CLOTHES AIRER

- Solid beechwood structure
- Independent nylon grids
- Powder-coated aluminium rods
- Double orientable baskets for clothes pins
- Lockable revolving wheels made in rubber non-scratch
- Hanging space 30 linear metres

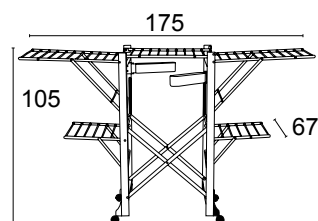

ARIT



cm 12

SISTEMA APRIFACILE UNICO NEL SUO GENERE *EASY TO OPEN SYSTEM UNIQUE IN ITS WAY*



Gabbiano



ciliegio - cherry wood



wenghé



laccato bianco - white laquered



Aliante

cod. 606

STENDIBIANCHERIA

- Struttura in legno massiccio
- Griglie indipendenti in nylon
- Aste in alluminio verniciato a polveri
- Vaschetta portamollette orientabile
- Ruote piroettanti antitraccia
- 24 mt di filo utile

CLOTHES AIRER

- Solid beechwood structure
- Independent nylon grids
- Powder-coated aluminium rods
- Orientable baskets for clothes pins
- Lockable revolving wheels made in rubber non-scratch
- Hanging space 24 linear metres

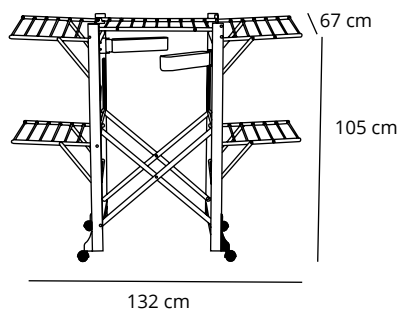

Airone

cod. 999

**SISTEMA APRIFACILE
UNICO NEL SUO GENERE**
EASY TO OPEN SYSTEM UNIQUE IN ITS WAY

STENDIBIANCHERIA

- Telaio portante in faggio massiccio
- 3 telai in nylon e alluminio verniciato
- 21 metri di filo utile
- Ruote per un facile spostamento
- Vaschetta portamollette orientabile
- Chiuso occupa poco spazio

CLOTHES AIRER

- Solid beechwood structure
- Independent nylon grids
- Powder-coated aluminium rods
- Orientable baskets for clothes pins
- Revolving wheels made in rubber non-scratch
- Hanging space 21 linear metres

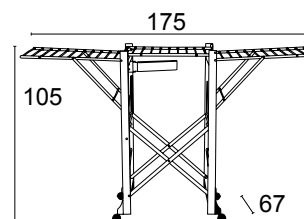

cm 10

ESEMPI DI UTILIZZO PELLIKANO

EXAMPLES OF PELLIKANO USE



semplice da applicare e togliere
easy to apply and remove



Stendibiancheria più 1 Pellikano
Clotheshorse with 1 Pellikano



Stendibiancheria più 2 Pellikano
Clotheshorse with 2 Pellikano

ARIT

STENDIBIANCHERIA

- Struttura in faggio massiccio
- 7 griglie indipendenti in nylon
- Aste in alluminio verniciato a polveri
- Ruote piroettanti e bloccanti antitraccia
- 27 metri di filo utile

Aquilone

cod. 602

CLOTHES AIRER

- Solid beechwood structure
- 7 Independent nylon grids
- Powder-coated aluminium rods
- Revolving wheels made in rubber non-scratch
- Hanging space 32 linear metres

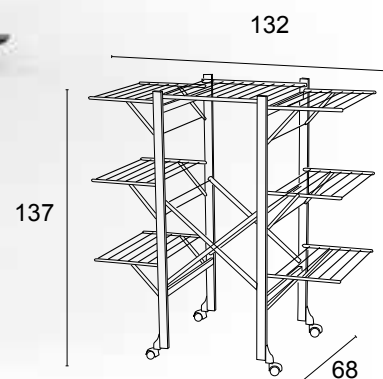



SISTEMA APRIFACILE UNICO NEL SUO GENERE
EASY TO OPEN SYSTEM UNIQUE IN ITS WAY



chiuso cm 12 - closed cm 12



AQUILONE PIÙ 1 PELLIKANO
AQUILONE WITH 1 PELLIKANO

STENDIBIANCHERIA DA TERMOARREDO

- Realizzato in faggio massiccio
- Griglie indipendenti in nylon
- Aste in alluminio verniciate a polvere
- Facilmente richiudibile
- 10 metri di filo utile
- Dotato di sistema di aggancio a scomparsa

Klaus

 cod. 608

RADIATOR CLOTHES AIRER

- Solid beechwood structure
- Independent nylon grids
- Powder-coated aluminium rods
- Easy closing system
- Easy radiator fixing system thanks to 2 retractable hooks
- Hanging space 10 linear metres

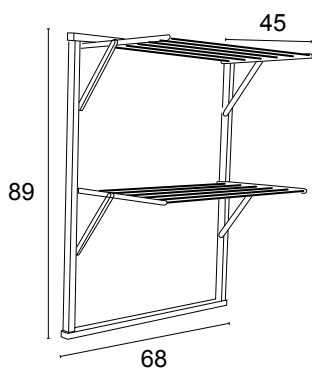

Gancio a scomparsa - attachment a disappearance



LO STENDIPARETE

- Solida struttura in faggio massiccio
- Dotato di sistema per fissaggio a parete
- Comodo per piccoli spazi
- 6,5 mt filo utile

Kledy

 cod. 604

CLOTHES AIRER FOR THE WALL

- Solid beechwood structure
- Powder-coated aluminium rods
- Provided with a suitable wall fixing system
- Hanging space 6.5 linear metres



ciliegio - cherry wood

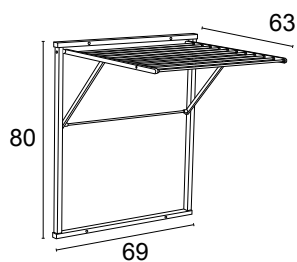

laccato bianco - white laquered



STENDIBIANCHERIA A TORRE

Karisma

cod. 695

TOWER CLOTHES AIRER

- 25 mt filo utile
- Hanging space 25 linear meters



chiuso cm 9
closed cm 9

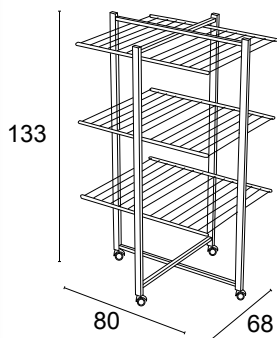

ARIT

LO STENDIPARETE TOTALWOOD

- Dotato di sistema per fissaggio a parete
- Comodo per piccoli spazi
- 6,2 mt filo utile
- Trattato con prodotto idrorepellente

Karim

cod. 616

CLOTHES AIRER FOR THE WALL

- Solid beechwood structure
- Treated with a water-repellent product
- Provided with a suitable wall fixing system
- Hanging space 6.5 linear metres

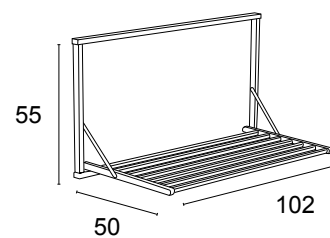

Chiuso occupa solo 4 cm
Closed takes up only 4 cm



Possibilità di montaggio reversibile per adattarlo ad ogni spazio
Possibility of reversible mounting to be adapted to any space

ARIT

Agilyssimo

cod. 685

STENDIBIANCHERIA

- Struttura in faggio massiccio
- Aste in alluminio verniciate a polvere
- Ruote alla base che "lavorano" in posizione chiusa
- Facile sistema di chiusura

CLOTHES AIRER

- Solid beechwood structure
- Powder-coated aluminium rods
- Easy closing system
- Revolving wheels that only work when in the closed position

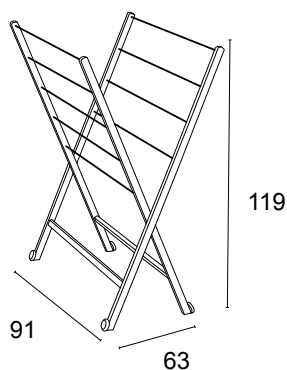

filo utile metri 7,5
hanging space 7.5 linear meters



chiuso cm 12
closed cm 12



STENDIBIANCHERIA

Agile

cod. 680

CLOTHES AIRER

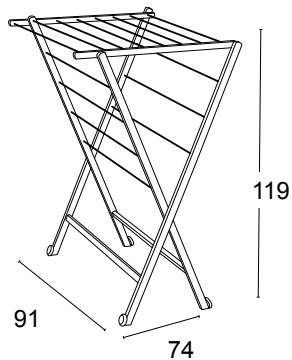

filo utile metri 12,3
hanging space 12,3 linear meters



chiuso cm 15
closed cm 15



Particolare griglia superiore
Wide upper grid, equipped with 2 lateral hooks

ARIT



LAUNDRY BASKET

- Solid beechwood structure
- Bag made in cotton
- Easy to close
- Revolving wheels made in rubber non-scratch

Banny

cod. 605

PORTABIANCHERIA

- Struttura in faggio massiccio
- Sacca in Ecrù estraibile
- Ruote piroettanti antiraccia
- Facilmente richiudibile

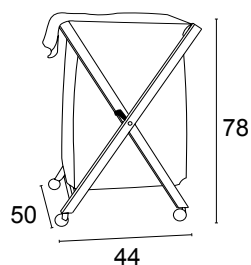

ciliegio - cherry wood



laccato bianco - white laquered

Marion

cod. 615

PORTASALVIETTE

- Struttura in faggio massiccio
- Piedini in gomma alla base

TOWELS HOLDER

- Solid beechwood structure
- Rubber feet at the base to protect any surface

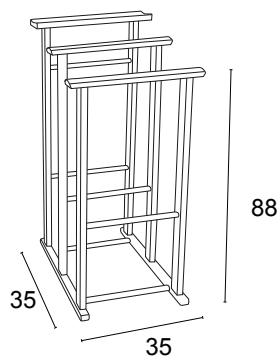

naturale - natural



laccato bianco - white laquered

Samoa

cod. 1960 (58x58)

cod. 1970 (68x68)

PEDANE DOCCIA

- Interamente legno massiccio di faggio
- Rifiniture artigianali
- Stecche avvitate con viti acciaio inox
- Speciale trattamento idrorepellente

SHOWER PLATFORM

- Entirely made in solid beechwood
- handcraft finishing
- Special water-repellent treatment
- Rubber feet on the base
- Wooden Rods screwed with stainless steel screws

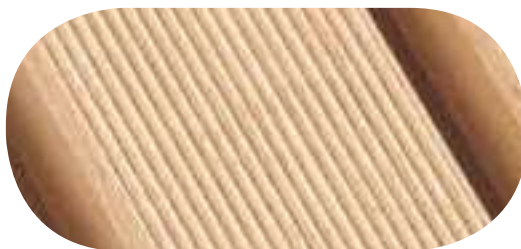

Particolare zigrinatura rilassante
Particular "relaxing knurling"



ARIT

APPENDI

HANGER

Fisar cod. 110

PORTASALVIETTE CHIUDIBILE

- Struttura in faggio massiccio
- Si può disporre in molteplici forme
- Piedini in gomma alla base

FOLDING TOWELS HOLDER

- Solid beechwood structure
- Rubber feet at the base to protect any surface
- Easy opening and closing system
- Adjustable in many dimensions



ciliegio - cherry wood



laccato bianco - white laquered



chiuso cm 10
closed cm 10

Axel cod. 609

PORTA INDUMENTI DA MURO

- Struttura in legno massiccio
- Piedini in gomma alla base
- Composto da 5 aste in legno massiccio e portaoggetti superiore
- Gancio laterale porta indumenti
- Sistema di appoggio al muro per mantenere il prodotto nella corretta posizione.

GARMENT HOLDER FOR THE WALL

- Solid beechwood structure
- Rubber feet at the base to protect any surface
- Composed by 5 rods made in beech woods and upper shelf
- Lateral hook clothing rack
- Supporting system for the wall to keep the product in the correct position.

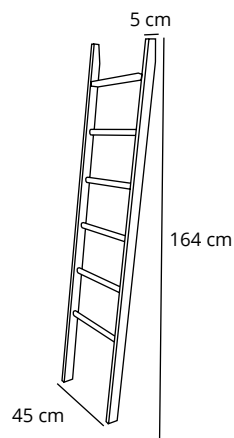

laccato bianco
white laquered



naturale
natural



Sagomata per un corretto appoggio al muro.
Shaped to a correct support to the wall.

IL METTINORDINE

- Realizzato in faggio massiccio
- Con barre acciaio estensibili sui 2 lati
- Ampio piano appoggio inferiore
- Ruote antitraccia piroettanti
- Facilmente richiudibile

FOLDING COAT RACK

- Solid beechwood structure
- Bar made in stainless steel extendible on two sides, from 78cm to 140cm
- Wide lower storage plan
- Revolving wheels made in rubber non-scratch
- Easy opening and closing system

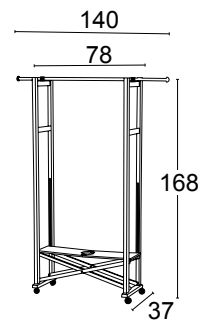

Elios

cod. 642



naturale - natural

laccato bianco - white laquered

ARIT



ciliegio - cherry wood



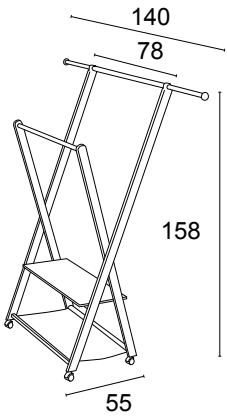

ARIT

ciliegio - cherry wood

Parsifal

cod. 640

PORTABITI

- Realizzato in faggio massiccio
- Con barre acciaio estensibili sui 2 lati
- 2 Ampi piani appoggio inferiore
- Ruote antitraccia piroettanti
- Facilmente richiudibile

FOLDING COAT RACK

- Solid beechwood structure
- Upper bar made in stainless steel extendible on two sides, from 78cm to 140cm, lower bar made in solid beechwood
- 2 Wide lower storage plans
- Revolving wheels made in rubber non-scratch
- Easy opening and closing system



laccato bianco - white laquered

ARIT

APPENDIABITI CHIUDIBILE

- Struttura in faggio massiccio
- Barra in acciaio satinato
- Ruote antitraccia piroettanti alla base
- Facilmente richiudibile
- Disponibile nelle versioni ciliegio e bianco

FOLDING COAT RACK

- Solid beechwood structure
- Bar made in stainless steel
- Revolving wheels made in rubber non-scratch
- Easy opening and closing system

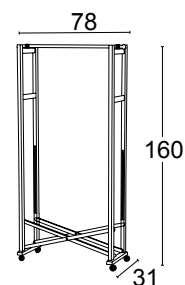

Giulyus cod. 644



ciliegio - cherry wood



laccato bianco - white laquered

Space 2 cod. 649

Portata massima 35 kg
Maximum load capacity 35 kg

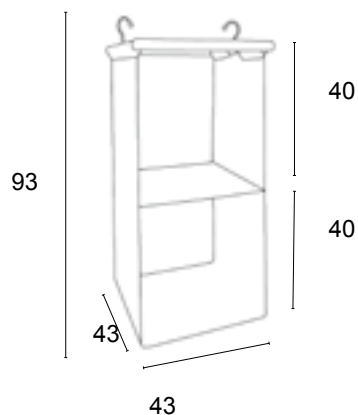

ORGANIZZATORE PER ARMADIO

- Struttura in faggio massiccio
- Gancio in metallo con terminale in gomma, per non permettere al gancio di muoversi dall'asta.
- Sacca in cotone colore Ecrù
- All'interno di ogni scomparto vi sono dei piani in laminato
- Molto resistente può portare fino a 30 kg

WARDROBE CLOTHES ORGANISER

- Structure in massive beech wood
- Hooks made in metal with terminal in rubber to keep the valet in the right position inside the wardrobe
- Cloth made in cotton 100%
- Inside each shelf there is a plan made in beech laminated
- Very sturdy maximum load weight 30 kg.



Space 3 cod. 650

Portata massima 35 kg
Maximum load capacity 35 kg

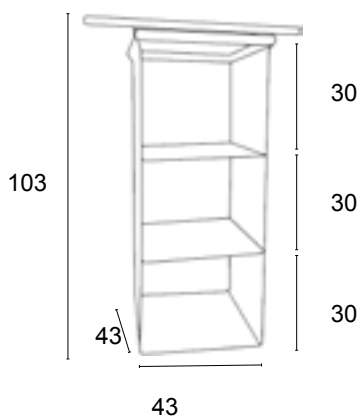

ARIT

Milord cod. 647

INDOSSATORE PER ARMADIO

- Struttura in faggio massiccio
- Gancio in metallo con terminale in gomma per mantenerlo dritto sull'asta del vostro armadio
- Solido e resistente studiato per portare dai 4 ai 6 capi di abbigliamento
- Composto da 1 gruccia e tre supporti porta pantaloni



ciliegio - cherry wood



laccato bianco - white laquered

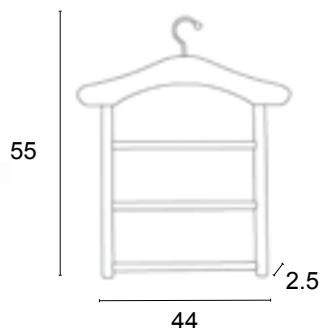

WARDROBE CLOTHES VALET

- Solid beechwood structure
- Metal hook with rubber tip to keep it straight on the rod of your wardrobe
- Solid and durable, designed to hold from 4 to 6 garments
- Composed of 1 hanger and 3 supports for pants

Milady cod. 648

INDOSSATORE PER ARMADIO

- Struttura in faggio massiccio
- Gancio in metallo con terminale in gomma per mantenerlo dritto sull'asta del vostro armadio
- Solido e resistente studiato per portare dai 4 ai 6 capi di abbigliamento
- Composto da 1 gruccia, 2 supporti porta pantaloni, mollette per gonne



ciliegio - cherry wood



laccato bianco - white laquered

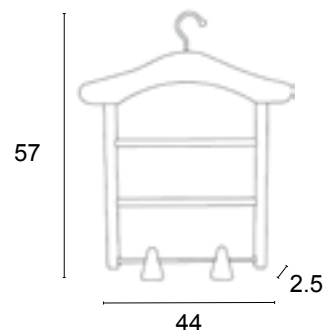

WARDROBE CLOTHES VALET

- Solid beechwood structure
- Metal hook with rubber tip to keep it straight on the rod of your wardrobe
- Solid and durable, designed to hold from 4 to 6 garments
- Composed of 1 hanger, 2 supports for pants and 2 clips for skirts.

Orei

cod. 641

COPPIA DI GRUCCE PORTA FOULARD

- Interamente legno massiccio di faggio
- Gancio in acciaio satinato
- Ideale per sciarpe foulard cravatte

COUPLE OF SCARF RACKS

- Entirely made in Beech wood
- Hook made in stainless steel
- Ideal for ties foulard scarves

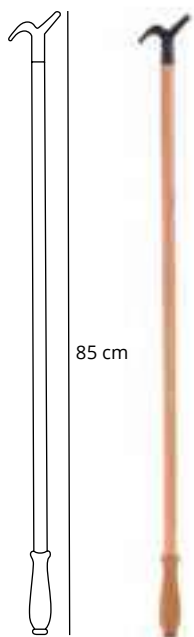
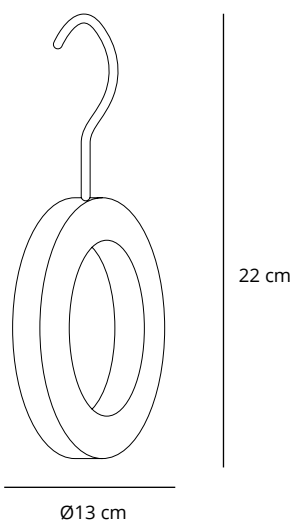

Alfonso

cod. 643

ASTA PER ARMADIO

- Interamente in faggio massiccio
- Gancio in nylon
- Manico tornito

ROD FOR WARDROBE

- Entirely made in solid beechwood
- Hook made in nylon
- Contoured handle



SOGGIORNO

LIVING-ROOM

CARRELLO SERVIZIO

- Struttura in faggio massiccio
- Ripiani in laminato antigraffio
- Sistema di chiusura brevettato
- Ruote piroettanti antitraccia

Gimmy cod. 570

SERVING TROLLEY

- Solid beechwood structure
- Shelves made in laminated non-scratch
- Patented closing and opening system
- Revolving wheels made in rubber non-scratch

naturale - natural

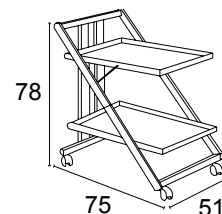

ciliegio - cherry wood



chiuso cm 11
closed cm 11

ARIT

Simpaty cod. 575

CARRELLO SERVIZIO

- Struttura in faggio massiccio
- Ripiani in truciolare nobilitato antigraffio
- Sistema di chiusura brevettato
- Ruote piroettanti antitraccia

laccato bianco
white laquered

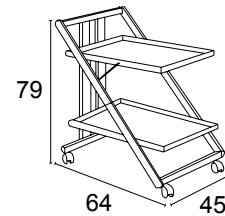

SERVING TROLLEY

- Solid beechwood structure
- Shelves made in laminated non-scratch
- Patented closing and opening system
- Revolving wheels made in rubber non-scratch



chiuso cm 10
closed cm 10

ciliegio - cherry wood

ARIT

Gregory

cod. 3310

CARRELLO ARREDO

- struttura in faggio massiccio
- 3 ripiani in vetro sintetico fumè
- ruote piroettanti antitraccia

SERVING / DECOTRATIVE TROLLEY

- Solid beechwood structure
- 3 wide shelves made in synthetic glass
- Revolving wheels made in rubber non-scratch



laccato bianco - white laquered

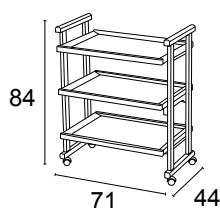

ciliegio - cherry wood

Anthony

cod. 2210

CARRELLO ARREDO

- struttura in faggio massiccio
- 2 ripiani in vetro sintetico fumè
- ruote piroettanti antitraccia

SERVING / DECOTRATIVE TROLLEY

- Solid beechwood structure
- 2 wide shelves made in synthetic glass
- Revolving wheels made in rubber non-scratch



ciliegio - cherry wood

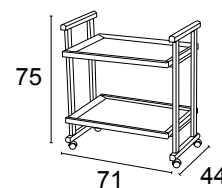

laccato bianco - white laquered

Zordan

cod. 576



ciliegio/bianco - cherry/white

CARRELLO SERVIZIO

- struttura in faggio massiccio
- ripiani in truciolare nobilitato massellati
- ruote piroettanti antitraccia
- particolare abbinamento ciliegio/bianco

SERVING / DECORATIVE TROLLEY

- Solid beechwood structure
- 3 shelves made in noble chipboard with frames in solid beechwood.
- Revolving wheels made in rubber non-scratch

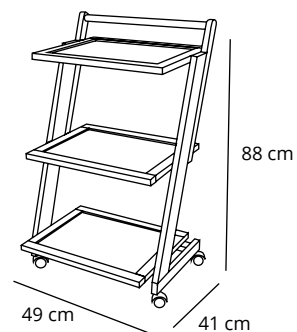

ARIT

TAVOLO

- Struttura in faggio massiccio
- Piani in truciolare nobilitato massellati
- Facilmente richiudibile
- Piano girevole
- Piedini regolabili
- Ruote piroettanti e bloccanti
- Può contenere n° 6 sedie Diana

Indaco cod. 652



FOLDING TABLE

- Solid beechwood structure
- Plans made in noble chipboard with frames in solid beechwood.
- Easy closing and opening system
- Revolving plan
- Revolving wheels made in rubber non-scratch
- Lockable revolving wheels made in rubber non-scratch
- When closed may contain 6 chairs Diana

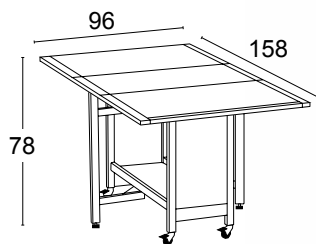
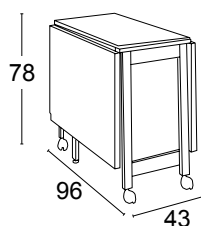



TAVOLO CONSOLLE CHIUDIBILE

- Struttura in faggio massiccio
- Piani in truciolare nobilitato
- Facilmente richiudibile
- Piedini antiscivolo alla base

FOLDING TABLE

- Solid beechwood structure
- Plans made in noble chipboard
- Easy closing and opening system
- Rubber feet at the base

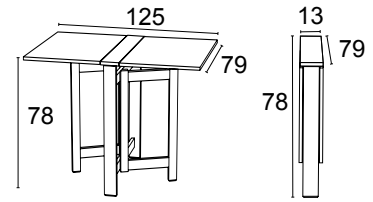

Smile

cod. 654



ARIT

ciliegio - cherry wood

SEDIA CHIUDIBILE

- Struttura in faggio massiccio
- Seduta in listellare di faggio
- Piedini antiscivolo

Diana

cod. 660

FOLDING CHAIR

- Solid beechwood structure
- Sitting made in lamellate of solid beechwood
- Rubber feet at the base



ciliegio - cherry wood



laccato bianco - white laquered



chiuso cm 6
closed cm 6

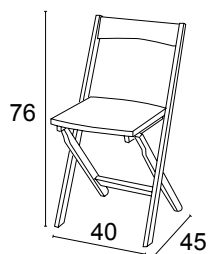

CARRELLO PORTASEDIE

- Può contenere fino a 6 sedie Diana

Zeus

cod. 655

TRANSPORTER CHAIR

- Can hold 6 Diana chairs



ciliegio - cherry wood

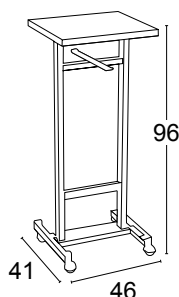

ARIT

SGABELLO

- Struttura in faggio massiccio
- Ripiano in listellare di faggio
- Piedini antiscivolo alla base
- Ideale come appoggio per poltrone

Nello

 cod. 400

STOOL

- Structure in massive beech wood
- Beech wood lamellate shelf
- Non-slip feet at the base
- Ideal as a resting for armchairs

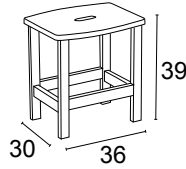

Liola

 cod. 721

TAVOLINO DA SERVIZIO

- Struttura in faggio massiccio
- Ripiani in truciolare nobilitato antigraffio
- Cornici in faggio massiccio
- Ruote piroettanti antitraccia

LITTLE SERVING TABLE

- Solid beechwood structure
- 2 shelves made in laminated non-scratch
- frames in solid beechwood.
- Revolving wheels made in rubber non-scratch

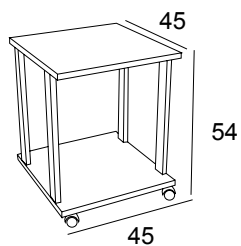

ciliegio - cherry wood

laccato bianco
white laquered





Billy

 cod. 551

TAVOLINO DA THÉ

- Struttura in faggio massiccio
- Vassoio asportabile in laminato
- Facilmente chiudibile
- Ruote piroettanti antitraccia

TEA TABLE

- Solid beechwood structure
- Removable tray made in laminated non-scratch with frame in beechwood
- Easy closing and opening system.
- Revolving wheels made in rubber non-scratch

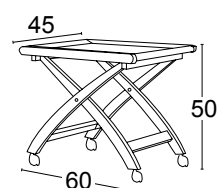

PORTARIVISTE

- Struttura in faggio massiccio
- 4 ampi spazi
- Tasche in tessuto textilene
- Piedini antiscivolo

Matrix

cod. 717

MAGAZINE HOLDER

- Solid beechwood structure
- 4 wide spaces for your magazine and newspaper
- Cloth made in textilene
- Rubber feet at the base to protect any surface

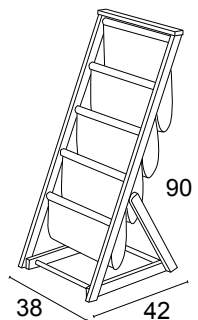

ARIT

Orfeo

cod. 916

PORTAOMBRELLI

- Struttura in faggio massiccio
- Ampia vaschetta raccoglie gocce
- Griglia con aste in alluminio verniciate a polveri
- Piedini in gomma alla base

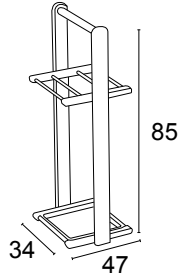

ciliegio - cherry wood

UMBRELLA STAND

- Solid beechwood structure
- Large drip tray
- Upper grid with aluminium rods
- Rubber feet at the base to protect any surface



laccato bianco - white laquered



ARIT

CASSETTIERA

- Struttura in truciolare nobilitato
- Testate cassetti in faggio massiccio
- Ripiano in truciolare nobilitato
- Ruote piroettanti antiraccia

CHEST OF DRAWERS

- Structure made in noble chipboard
- Drawers made in solid beechwood
- Upper plan made in noble chipboard
- Lockable Revolving wheels made in rubber non-scratch

Afrodite

cod. 583

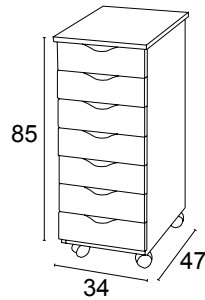

ciliegio - cherry wood



laccato bianco - white laquered

SCARPIERE

SHOE CABINET

Gioia cod. 880/3 (9 posti)

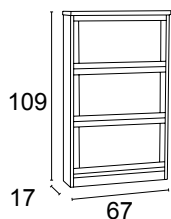

ciliegio - cherry wood



laccato bianco - white lacquered



noce - walnut

ARIT

ripiano e cornici in legno massiccio
Frames and upper plan made in solid beechwood

Gioia

cod. 880/4 (12 posti)

SCARPIERA

- Struttura truciolare nobilitato
- Cornici e ripiano superiore in legno massiccio
- Singola apertura delle antine
- Piedini in gomma alla base

SHOE CABINET

- Structure made in noble chipboard
- Upper plan made in solid beechwood
- Single opening of doors
- Doors made in laminated with frame in solid beechwood
- Rubber feet at the base to protect any surface



ciliegio - cherry wood



laccato bianco - white lacquered



noce - walnut

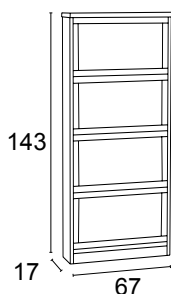

Singola apertura delle antine
Single opening of doors



ARIT

Grazia

cod. 883

SCARPIERA DOPPIA

- Struttura in faggio massiccio
- Piano superiore in truciolare nobilitato
- Singola apertura delle ante
- Ogni antina può contenere 6 paia di scarpe
- Antine realizzate in laminato con cornici in faggio massello



ciliegio - cherry wood

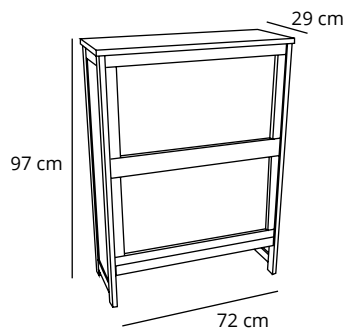

SHOE CABINET

- Structure made in solid beechwood
- Upper plan made in noble chipboard
- Single opening of doors
- Each door can contain 6 pairs of shoes
- Doors made in laminated with frame in solid beechwood
- Rubber feet at the base to protect any surface



laccato bianco - white lacquered



PORTA SCARPE MODULARE

- Struttura in faggio massiccio
- Aste in metallo rivestite con gomma
- Piedini di gomma alla base
- Sovrapponibile senza agganci
- Ogni modulo può contenere 6 paia di scarpe

Todys

 cod. 888

MODULAR SHOE RACK

- Structure made in solid beechwood
- Metal rods plastic-covered
- Innovative modular system, without any hook
- Each module can hold 6 pairs of shoes
- Rubber feet at the base to protect any surface

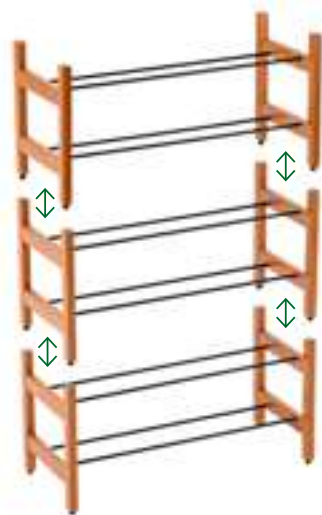
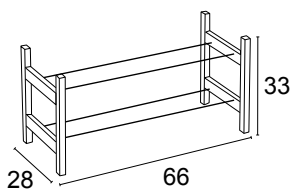

Todyssimo

 cod. 889

PORTA SCARPE

- Struttura in faggio massiccio
- Aste in metallo rivestite con gomma
- Piedini di gomma alla base
- Può contenere 18 paia di scarpe

SHOE RACK

- Structure made in solid beechwood
- Metal rods plastic-covered
- Can hold 18 pairs of shoes
- Rubber feet at the base to protect any surface

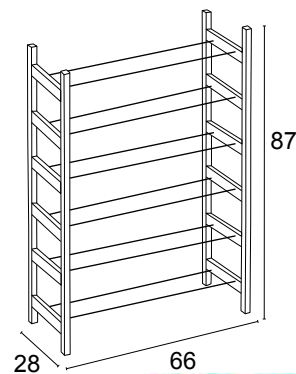

ARIT



SCALE

LADDER

LA SEDIA SCALETTA

- Innovativa e robusta
- Gradini in legno antiscivolo
- Sistema di sicurezza con bloccaggi
- Un semplice movimento trasforma la sedia in scala
- Collaudati piedini antiscivolo alla base
- Chiusa sta in piedi da sola

THE LADDER – CHAIR

- Innovative and sturdy, entirely made in beechwood
- 4 steps anti-slip made in solid beechwood
- Safety system with clamps
- With a simple movement chair becomes a ladder
- Easy closing and opening system
- When closed, it stands alone

Eletta

cod. 175

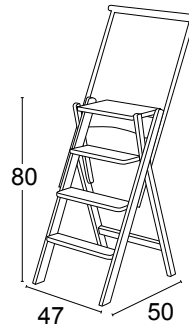
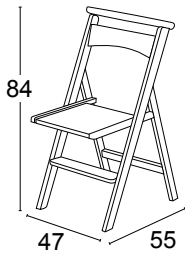

ARIT

SCALE

- Completamente in faggio massiccio
- Semplicissimo sistema di chiusura
- Piedini in gomma antiscivolo alla base
- Gradini antiscivolo
- Ampia pedana per uno stabile appoggio

Kimora

 cod. 180

FOLDING LADDER

- Entirely made in beechwood
- Steps anti-slip made in solid beechwood
- Rubber feet at the base to protect any surface
- Easy closing and opening system
- Wide footboard for a safety using





cod. 180/4



cod. 180/3



cod. 180/2



MISURE SCALE / LADDER SIZE	180/4	180/3	180/2
Chiusa / Close	h 148 - L 48 - p 9	h 123 - L 48 - p 9	h 98 - L 48 - p 9
Aperta / Open	h 141 - L 48 - p 77	h 116 - L 48 - p 66	h 94 - L 48 - p 51
Altezza pedana / platform height	80	60	40

SGABELLO SCALETTA

Osimo cod. 70

LITTLE LADDER

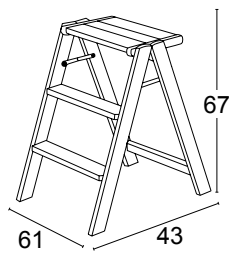

ARIT



SCALE

- Struttura in faggio massiccio
- Robusta e molto sicura
- Dotata di pedana per uno stabile appoggio
- Ampio portaattrezzi superiore
- Sistema di apertuta brevettato
- Chiusa sta in piedi da sola
- Gradini antiscivolo
- Facilmente spostabile grazie alle ruote che lavorano solo nella posizione chiusa

Tuscania

FOLDING LADDER

- Innovative and sturdy, entirely made in beechwood
- Steps anti-slip made in solid beechwood
- Wide footboard for a safety using
- With upper tool box
- Safety system with clamps
- Easy to move thanks to 4 non-scratch wheels that only work in a closed position
- With a simple movement chair becomes a ladder
- Patented closing and opening system
- When closed, it stands alone



ARIT

Tuscania



guida di scorrimento in nylon
nylon non-slip guideway



cod. 170/3

cod. 170/4



MISURE SCALE / LADDER SIZE	170/3	170/4	170/5	170/6
Chiusa / Close	h 99 - L 49,5 - p 12	h 118 - L 49,5 - p 12	h 138 - L 49,5 - p 12	h 164 - L 49,5 - p 12
Aperta / Open	h 145 - L 49,5 - p 65	h 162 - L 49,5 - p 65	h 182 - L 49,5 - p 69	h 206 - L 49,5 - p 110
Altezza pedana / platform height	72	89	109	132



cod. 170/5



cod. 170/6



pedino antiscivolo
non-slip foot



ruota antitraccia
anty-trace wheel



CAMERA

BEDROOM



naturale - natural

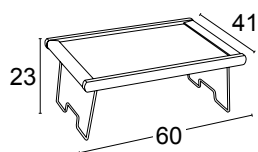

ciliegio - cherry wood

Melfo cod. 470

VASSOIO COLAZIONE

- Cornice in faggio massiccio
- Ripiano in laminato
- Telaio d'appoggio in metallo
- Facilmente richiudibile

BREAKFAST TRAY

- Shelf made of laminated
- Frames made of solid beechwood
- Metal coated legs
- Easy closing and opening system

ARIT

APPENDI PANTALONI

- Struttura in faggio massiccio
- Pinze appendigonna
- Ampia vaschetta portaoggetti
- Pratico portacravatte / portacinture
- Piedini in gomma alla base
- Innovativo sistema appendipantaloni

Joseph

cod. 2005

CLOTHES VALET

- Structure made in solid beechwood
- Large storage compartment
- Innovative pants hanger system
- 2 hanging clips for skirts
- Convenient tie/belt holder
- Rubber feet at the base to protect any surface

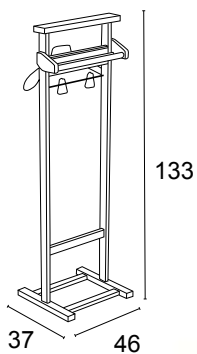

Mixer

cod. 2003

INDOSSATORE DOPPIO

- Struttura in faggio massiccio
- Elegante portabiti da camera
- Doppia spalla appendigiacca
- Pinze appendigonna
- Vaschetta portaoggetti
- Ruote piroettanti antitraccia

DOUBLE CLOTHES VALET

- Structure made in solid beechwood
- Elegant clothes valet
- Double clothes hangers
- 2 hanging clips for skirts
- Little object case
- Revolving wheels made in rubber non-scratch



laccato bianco
white lacquered



ciliegio - cherry wood

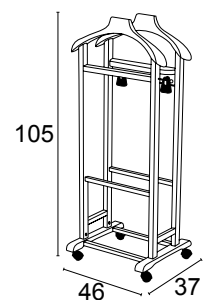

Mirano

cod. 2002

INDOSSATORE

- Struttura in faggio massiccio
- Elegante portabiti da camera
- Vaschetta portaoggetti
- Ruote piroettanti antitraccia

DOUBLE CLOTHES VALET

- Structure made in solid beechwood
- Elegant clothes valet
- Clothes hanger and pants holder
- Little object case
- Revolving wheels made in rubber non-scratch



ciliegio - cherry wood



laccato bianco
white lacquered

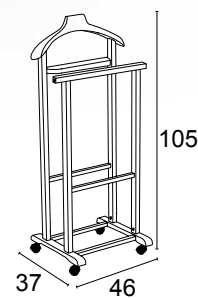

ARIT

Antimo

cod. 18

INDOSSATORE

- Struttura in faggio massiccio
- Ruote antitraccia alla base
- Pratica vaschetta vuotatasche

CLOTHES VALET

- Structure made in solid beechwood
- Clothes hanger and pants holder
- Little object case
- Revolving wheels made in rubber non-scratch



ciliegio - cherry wood



laccato bianco
white lacquered

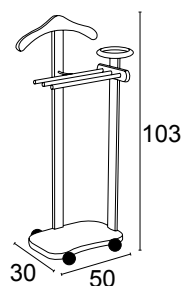

INDOSSATORE

- Classico servo muto da camera
- Completamente in faggio massiccio
- Ruote antiraccia alla base

Atri cod. 102

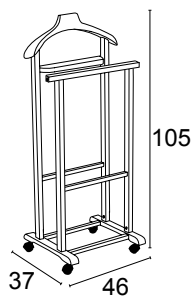

CLOTHES VALET

- Structure made in solid beechwood
- Clothes hanger and pants holder
- Classic room valet
- Revolving wheels made in rubber non-scratch



laccato bianco
white lacquered



naturale - natural



ciliegio - cherry wood



Simply

cod. 101

INDOSSATORE SEMPLICE

- Classico servo muto da camera
- Struttura in faggio massiccio
- Piedini in gomma alla base

SIMPLY CLOTHES VALET

- Structure made in solid beechwood
- Clothes hanger and pants holder
- Classic room valet
- Rubber feet at the base to protect any surface



ciliegio - cherry wood



laccato bianco
white lacquered

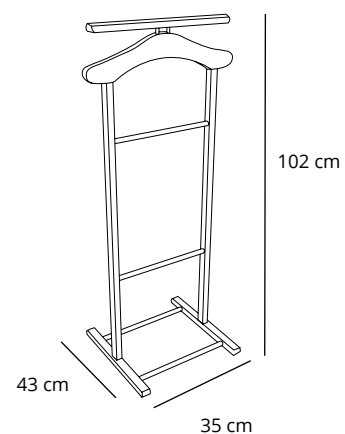

Maxy cod. 107

TRIPLE CLOTHES VALET

- Structure made in solid beechwood
- Clothes hanger and pants holder
- Rubber feet at the base to protect any surface

INDOSSATORE TRIPLO

- Classico servo muto da camera
- Struttura in faggio massiccio
- Piedini in gomma alla base



ciliegio - cherry wood



laccato bianco
white lacquered

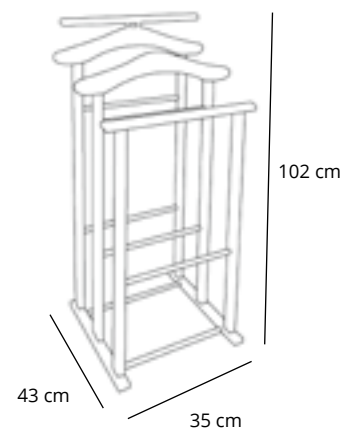

ARIT

Trendy

cod. 103

INDOSSATORE DOPPIO

- Struttura in faggio massiccio
- Ruote piroettanti in gomma anti traccia
- Composto da due grucce porta abiti e un asta porta pantaloni

DOUBLE CLOTHES VALET

- Structure made in solid beechwood
- Clothes hanger and pants holder
- Revolving wheels made in rubber non-scratch



ciliegio - cherry wood



laccato bianco
white lacquered

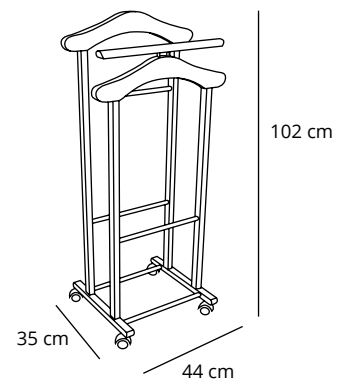

ARIT

Clever

cod. 104

INDOSSATORE DOPPIO

- Struttura in faggio massiccio
- Ruote piroettanti in gomma anti traccia
- Composto da due grucce porta abiti e due aste porta pantaloni

DOUBLE CLOTHES VALET

- Structure made in solid beechwood
- Clothes hanger and pants holder
- Revolving wheels made in rubber non-scratch



ciliegio - cherry wood

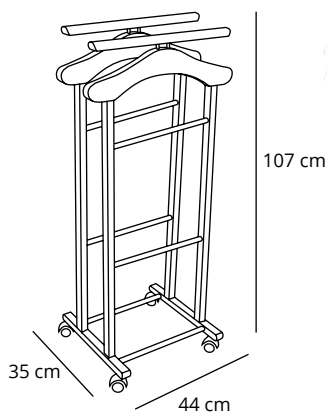

laccato bianco
white lacquered



ARIT

INDOSSATORE CHIUDIBILE

- Struttura in faggio massiccio
- Facilmente richiudibile
- Ruote antitraccia
- Appoggio in tessuto textilene

FOLDING CLOTHES VALET

- Structure made in solid beechwood
- Clothes hanger and pants holder
- Easy to close
- Revolving wheels made in rubber non-scratch

Nelson

cod. 119

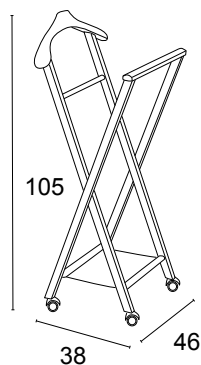

ARIT

Duka

cod. 2007

INDOSSATORE SEDIA

- Struttura in faggio massiccio
- Seduta in listellare di faggio
- Ampia vaschetta portaoggetti
- Chiuso sta in piedi da solo

CHAIR – CLOTHES VALET

- Structure made in solid beechwood
- Clothes hanger and pants holder
- Sitting made in lamellate of solid beechwood
- Rubber feet at the base to protect any surface

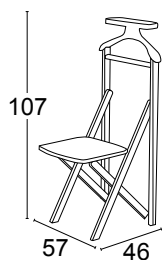

ARIT

INDOSSATORE

- Struttura in faggio massiccio
- Ruote antitraccia alla base
- Pratica vaschetta vuotatasche

Junior

 cod. 105

CLOTHES VALET

- Structure made in solid beechwood
- Clothes hanger and pants holder
- Little object case
- Revolving wheels made in rubber non-scratch

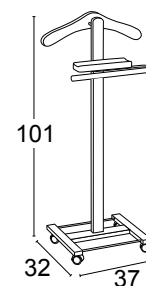
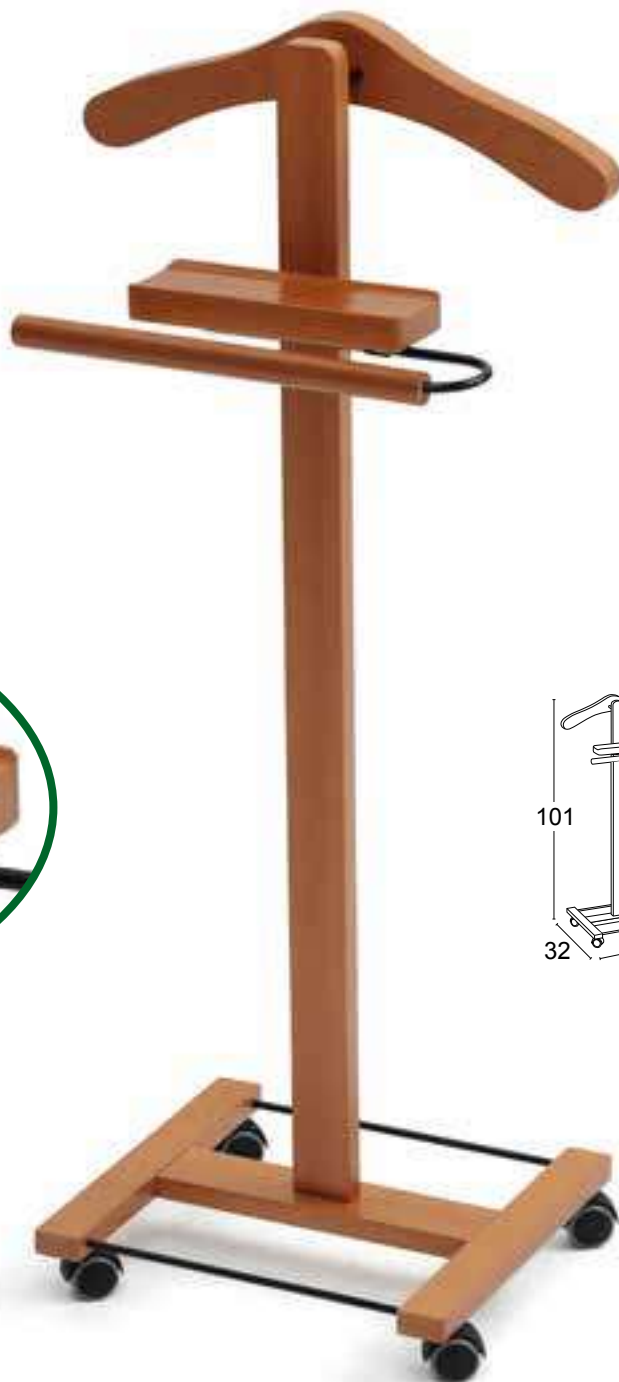
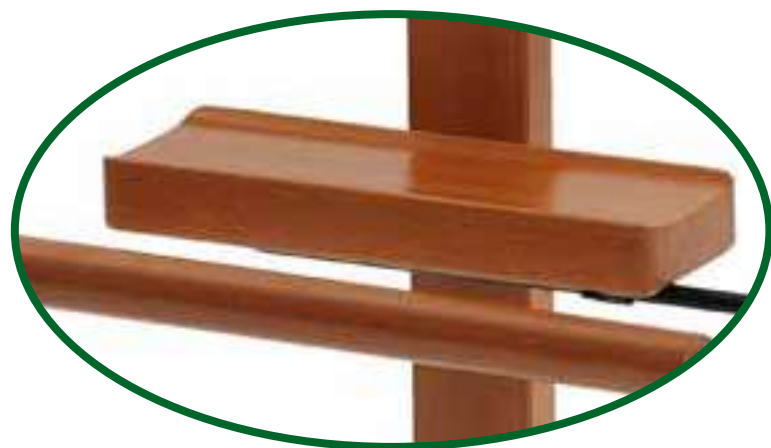

PORTACRAVATTE

- Struttura in faggio massiccio
- 23 ganci orientabili
- Applicabile all'anta dell'armadio

Red

 cod. 639

TIE RACK

- Structure in massive beech wood
- 23 orientable hooks
- Can be fit to the wardrobe door



INDOSSATORE – STIRAPANTALONI

- Struttura truciolare nobilitato
- Base e dettagli in legno massiccio
- Gruccia per abiti e portaoggetti in legno massello.
- Sistema stirante, per mantenere i pantaloni senza pieghe (non elettrico)
- Ruote piroettanti in gomma anti traccia

Wigi cod. 100

CLOTHES VALET – IRONING TROUSERS

- Structure made in noble chipboard
- Sturdy base and details made of solid beechwood
- Clothes hanger and object case made in solid beechwood
- Ironing system, to keep the trousers without folds (not electric)
- Revolving wheels made in rubber non-scratch



ciliegio - cherry wood



laccato bianco
white lacquered

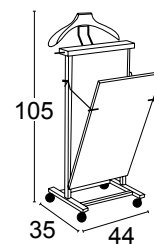

ARIT

I NOSTRI CONTATTI - OUR CONTACTS

Telefono - Telephone

+39 0365 896668

WhatsApp



+39 388 6247350

Lun. Ven. 9:00 - 12:30 / 14:00 - 18:00

Indirizzi - Addresses

Sede amministrativa direttiva:

Arredamenti Italia Group s.r.l. via Combattenti e Reduci, 6 25070 Bione Bs – Italia.

Sede operativa:

Arredamenti Italia Group s.r.l. via Combattenti e Reduci, 6a 25070 Bione Bs – Italia

Sede legale:

Arredamenti Italia Group s.r.l. via Sostegno 60 25124 Brescia

Servizio clienti - Customer care

contatto@arredamentiitalia.it

Recapiti - Email Addresses

Amministrazione - Admin dept.: amministrazione@arredamentiitalia.it

Supporto rivenditori - Retailers support: clienti@arredamentiitalia.it

Informazioni - General information: info@arredamentiitalia.it

Ufficio commerciale - Commercial dept. : commerciale@arredamentiitalia.it

Estero - Export dept. : export@arredamentiitalia.it

Customer care export: customer@arredamentiitalia.it

CATALOGO - CATALOGUE N. 35 OTTOBRE 2018

Nell'ottica di un continuo miglioramento qualitativo Arredamenti Italia si riserva di modificare i prodotti del catalogo, senza preavviso.

In order to improve the quality of the products, Arredamenti Italia reserves the rights to modify the products of the catalogue, also without notice.



ARIT
GENERATION...



Arredamenti Italia - ARIT



arredamentiitalia_arit



Arredamenti Italia - ARIT

www.ar-it.it
www.arredamentiitalia.it



WWW.ARREDAMENTIITALIA.IT
WWW.AR-IT.IT

EXPORT: export@arredamentiitalia.it
customer@arredamentiitalia.it

ITALIA: info@arredamentiitalia.it
clienti@arredamentiitalia.it
commerciale@arredamentiitalia.it
amministrazione@arredamentiitalia.it



CANALI SOCIAL:

 [Arredamenti Italia - ARIT](#)

 [arredamentiitalia_arit](#)

 [Arredamenti Italia - ARIT](#)

RIVENDITORE AUTORIZZATO