

Made in Italy Collection

Foto	Descrizione
Poltrone - Armchairs	
 <p data-bbox="172 958 735 1021">W (96-146)cm x D (66-124)cm x H (108-50)cm Seat H 44cm x D 50cm - Arm H 55-71cm</p>	<p data-bbox="997 488 1286 551">POL-SIL0182 Poltrona Silvana in pelle Categoria 1</p>  <p data-bbox="997 674 1286 736">POL-SIL0183 Poltrona Silvana in pelle Categoria 2</p>  <p data-bbox="997 860 1286 922">POL-SIL0184 Poltrona Silvana in pelle Categoria 3</p> 
 <p data-bbox="172 1514 790 1576">W (96-146)cm x D (66-124)cm x H (108-120-50)cm Seat H 44-56cm x D 50cm - Arm H 55-71cm</p>	<p data-bbox="997 1043 1286 1106">POL-SIL0148 Poltrona Silvana in pelle imbottita Categoria 1</p>  <p data-bbox="997 1229 1286 1292">POL-SIL0156 Poltrona Silvana in pelle imbottita Categoria 2</p>  <p data-bbox="997 1415 1286 1478">POL-SIL0149 Poltrona Silvana in pelle imbottita Categoria 3</p> 
 <p data-bbox="172 2065 790 2128">W (96-146)cm x D (66-124)cm x H (108-120-50)cm Seat H 44-56cm x D 50cm - Arm H 55-71cm</p>	<p data-bbox="997 1599 1286 1662">POL-SIL0146 Poltrona Silvana in pelle Categoria 1</p>  <p data-bbox="997 1785 1286 1848">POL-SIL0158 Poltrona Silvana in pelle Categoria 2</p>  <p data-bbox="997 1971 1286 2033">POL-SIL0147 Poltrona Silvana in pelle Categoria 3</p> 



W 56cm x D (57-120)cm x H (108-120-50)cm
 Seat H (42-55)cm x D 44cm

POL-NEL0152

Poltrona Nella in pelle

Categoria 1



POL-NEL0159

Poltrona Nella in pelle

Categoria 2



POL-NEL0153

Poltrona Nella in pelle

Categoria 3



W 76cm x D 74cm x H 66cm - Seat H 42cm

POL-ANT0204

Poltrona Antigua
 in cuoio e pelle



W 82cm x D 78cm x H 91cm
 Seat H 43cm x D 49cm - Arm H 60cm - Weight 20kg

POL-AUS0179

Poltrona Austin
 in pelle categoria 1



POL-AUS0180

Poltrona Austin
 in pelle categoria 2



POL-AUS0181

Poltrona Austin
 in pelle categoria 3



W 82cm x D 78cm x H 91cm
 Seat H 43cm x D 49cm - Arm H 60cm - Weight 21,5kg

POL-AUS0198

Poltrona Austin
 in pelle categoria 1



POL-AUS0199

Poltrona Austin
 in pelle categoria 2



POL-AUS0200

Poltrona Austin
 in pelle categoria 3



 <p>W 82cm x D 78cm x H 91cm Seat H 43cm x D 49cm - Arm H 60cm - Weight 16kg</p>	<p>POL-AUS0201 Poltrona Austin in pelle categoria 1</p> 
<p>POL-AUS0202 Poltrona Austin in pelle categoria 2</p> 	<p>POL-AUS0203 Poltrona Austin in pelle categoria 3</p> 
 <p>W 82cm x D 78cm x H 82cm Seat H 43cm - Arm H 60cm - Weight 17kg</p>	<p>POL-POR0192 Poltrona Portland in pelle categoria 1</p> 
<p>POL-POR0193 Poltrona Portland in pelle categoria 2</p> 	<p>POL-POR0194 Poltrona Portland in pelle categoria 3</p> 
 <p>W 82cm x D 78cm x H 82cm Seat H 43cm - Arm H 60cm - Weight 18kg</p>	<p>POL-POR0195 Poltrona Portland in pelle categoria 1</p> 
<p>POL-POR0196 Poltrona Portland in pelle categoria 2</p> 	<p>POL-POR0197 Poltrona Portland in pelle categoria 3</p> 
 <p>W 82cm x D 78cm x H 82cm Seat H 43cm - Arm H 60cm - Weight 18kg</p>	<p>POL-POR0189 Poltrona Portland in pelle categoria 1</p> 
<p>POL-POR0190 Poltrona Portland in pelle categoria 2</p> 	<p>POL-POR0191 Poltrona Portland in pelle categoria 3</p> 



W 56cm x D 46cm x H 43cm - Weight 8kg

POG-POR0060

Pouf Portland
in categoria 1



W 74cm x D 91cm x H 91cm
Seat H 41cm - Weight 30kg

POL-ATL0167

Poltrona Atlanta in pelle
categoria 1



POL-ATL0168

Poltrona Atlanta in pelle
categoria 2



POL-ATL0169

Poltrona Atlanta in pelle
categoria 3



W 76cm x D 79cm x H 75cm
Seat H 42cm - Weight 39kg

POL-BAL0176

Poltrona Baltimora girevole
in pelle categoria 1



POL-BAL0177

Poltrona Baltimora girevole
in pelle categoria 2



POL-BAL0178

Poltrona Baltimora girevole
in pelle categoria 3



W 76cm x D 79cm x H 74cm
Seat H 42cm - Weight 39kg

POL-BAL0173

Poltrona Baltimora girevole
in pelle categoria 1



POL-BAL0174

Poltrona Baltimora girevole
in pelle categoria 2



POL-BAL0175

Poltrona Baltimora girevole
in pelle categoria 3





W 72cm x D 82cm x H 81cm
Seat H 46cm x D 50cm - Weight 30kg

POL-DAL0164

Poltrona Dallas girevole
in pelle categoria 1



POL-DAL0165

Poltrona Dallas girevole
in pelle categoria 2



POL-DAL0166

Poltrona Dallas girevole
in pelle categoria 3



W 92cm x D 102cm x H 92cm
Seat H 42cm - Weight 33kg

POL-FIL0170

Poltrona Filadelfia
in pelle categoria 1



POL-FIL0171

Poltrona Filadelfia
in pelle categoria 2



POL-FIL0172

Poltrona Filadelfia
in pelle categoria 3



W 73cm x D 66cm x H 150cm - Seat H 42cm

POL-PRI0205

Poltrona Throne
in categoria 1



POL-PRI0206

Poltrona Throne
in categoria 2



POL-PRI0207

Poltrona Throne
in categoria 3



W 73cm x D 68cm x H 70cm - Seat H 40cm

POL-MOR0185

Poltrona Morgan
in pelle categoria 1



POL-MOR0186

Poltrona Morgan
in pelle categoria 2



POL-MOR0187

Poltrona Morgan
in pelle categoria 3





W 60cm x D 60cm x H 40cm

POG-MOR0057

Pouf Morgan
in pelle categoria 1



POG-MOR0058

Pouf Morgan
in pelle categoria 2



POG-MOR0059

Pouf Morgan
in pelle categoria 3



W 70cm x D 70cm x H 73cm - Seat H 43cm

POL-BON0154

Poltrona BONTTON in pelle
Categoria 3



POL-BON0155

Poltrona BONTTON in pelle
con base girevole

Categoria 3



W 140cm x D 100cm x H 80cm - Seat H 42cm

POL-VIO0211

Poltrona Viola in pelle
categoria 1



POL-VIO0212

Poltrona Viola in pelle
Cat. 2 (Mix Cat.1 & Cat.3)



POL-VIO0213

Poltrona Viola in pelle
categoria 3



W 49cm x D 43cm x H (74-100)cm

Seat H (59-85)cm

- weight 23kg

SED-BAR0197

Sgabello Bar Space
in cromo lucido



SED-BAR0196

Sgabello Bar Space
in Nikel nero lucido



Divani - Sofas



W 310cm x D (120-180)cm x H 83cm
Seat H 40cm x D 60cm - 3pieces

DIV-HAR0309

Divano Harbor SX in pelle
Categoria 1 - 310 x 180



DIV-HAR0310

Divano Harbor SX in pelle
Categoria 2 - 310 x 180



DIV-HAR0311

Divano Harbor SX in pelle
Categoria 3 - 310 x 180



W 310cm x D (120-180)cm x H 83cm
Seat H 40cm x D 60cm - 3pieces

DIV-HAR0306

Divano Harbor DX in pelle
Categoria 1 - 310 x 180



DIV-HAR0307

Divano Harbor DX in pelle
Categoria 2 - 310 x 180



DIV-HAR0308

Divano Harbor DX in pelle
Categoria 3 - 310 x 180



W 310cm x D 120cm x H 83cm
Seat H 40cm x D 60cm - 3pieces

DIV-HAR0315

Divano Harbor in pelle
Categoria 1 - 310 x 120



DIV-HAR0316

Divano Harbor in pelle
Categoria 2 - 310 x 120



DIV-HAR0317

Divano Harbor in pelle
Categoria 3 - 310 x 120



W 220cm x D 120cm x H 83cm
Seat H 40cm x D 60cm - 2pieces

DIV-HAR0312

Divano Harbor in pelle
Categoria 1 - 220 x 120



DIV-HAR0313

Divano Harbor in pelle
Categoria 2 - 220 x 120



DIV-HAR0314

Divano Harbor in pelle
Categoria 3 - 2200 x 1200





DIV-TOP0359

Divano Topazio 2 posti

Categoria 1

210 x 113



DIV-TOP0360

Divano Topazio 2 posti

Cat. 2 (Mix Cat.1 & Cat.3)

210 x 113



DIV-TOP0361

Divano Topazio 2 posti

Categoria 3

210 x 113



DIV-TOP0362

Divano Chaise Topazio DX

Categoria 1

167 x 167



DIV-TOP0363

Divano Chaise Topazio DX

Cat. 2 (Mix Cat.1 & Cat.3)

167 x 167



DIV-TOP0364

Divano Chaise Topazio DX

Categoria 3

167 x 167



DIV-TOP0365

Divano Chaise Topazio SX

Categoria 1

167 x 167



DIV-TOP0366

Divano Chaise Topazio SX

Cat. 2 (Mix Cat.1 & Cat.3)

167 x 167



DIV-TOP0367

Divano Chaise Topazio SX

Categoria 3

167 x 167





DIV-DIA0368

Divano Diamante 2 posti

Categoria 1

210 x 113



DIV-DIA0369

Divano Topazio 2 posti

Cat. 2 (Mix Cat.1 & Cat.3)

210 x 113



DIV-DIA0370

Divano Diamante 2 posti

Categoria 3

210 x 113



DIV-DIA0371

Divano Chaise Diamante DX

Categoria 1

167 x 167



DIV-DIA0372

Divano Chaise Diamante DX

Cat. 2 (Mix Cat.1 & Cat.3)

167 x 167



DIV-DIA0373

Divano Chaise Diamante DX

Categoria 3

167 x 167



DIV-DIA0374

Divano Chaise Diamante SX

Categoria 1

167 x 167



DIV-DIA0375

Divano Chaise Diamante SX

Cat. 2 (Mix Cat.1 & Cat.3)

167 x 167



DIV-DIA0376

Divano Chaise Diamante SX

Categoria 3

167 x 167





DIV-DIA0377
Divano Diamante 2 posti
Categoria 1



DIV-DIA0378
Divano Diamante 2 posti
Cat. 2 (Mix Cat.1 & Cat.3)



DIV-DIA0379
Divano Diamante 2 posti
Categoria 3



POL-DIA0208
Poltrona Diamante
Categoria 1



POL-DIA0209
Poltrona Diamante
Cat. 2 (Mix Cat.1 & Cat.3)



POL-DIA0210
Poltrona Diamante **Categoria**
3



TAV-DIA0102
Tavolino divano Diamante e
Topazio composizione
angolare a moduli



TAV-DIA0103
Tavolino Poltrona Diamante e
Topazio composizione
modulare





W 220cm x D 105cm x H 78cm - Seat H 41cm x D 60cm

DIV-GAL0346

Divano Galaxy **Categoria 1**
250 x 105 x h 78



DIV-GAL0347

Divano Galaxy **Categoria 2**
250 x 105 x h 78



DIV-GAL0348

Divano Galaxy **Categoria 3**
250 x 105 x h 78



DIV-VEN0349

Divano Venere **Categoria 1**
250 x 100 x h 84



DIV-VEN0350

Divano Venere **Categoria 2**
250 x 100 x h 84



DIV-VEN0351

Divano Venere **Categoria 3**
250 x 100 x h 84



DIV-ARM0356

Divano Armony DX **Categ. 1**
360 x 195-132



DIV-ARM0357

Divano Armony DX **Categ. 2**
360 x 195-132



DIV-ARM0358

Divano Armony DX **Categ. 3**
360 x 195-132



DIV-ARM0353

Divano Armony SX **Categ. 1**
360 x 195-132



DIV-ARM0354

Divano Armony SX **Categ. 2**
360 x 195-132



DIV-ARM0355

Divano Armony SX **Categ. 3**
360 x 195-132





W 230cm x D 109cm x H (65-92)cm
Seat H 42cm x D 59cm - Arm H 54cm W 28cm

DIV-MIA0333

Divano Miami in pelle
Categoria 1 - 230 x 109



DIV-MIA0334

Divano Miami in pelle
Categoria 2 - 230 x 109



DIV-MIA0335

Divano Miami in pelle
Categoria 3 - 230 x 109



W 210cm x D 109cm x H (65-92)cm
Seat H 42cm x D 59cm - Arm H 54cm W 28cm

DIV-MIA0279

Divano Miami in pelle
Categoria 1 - 210 x 109



DIV-MIA0280

Divano Miami in pelle
Categoria 2 - 210 x 109



DIV-MIA0281

Divano Miami in pelle
Categoria 3 - 210 x 109



W 190cm x D 109cm x H (65-92)cm
Seat H 42cm x D 59cm - Arm H 54cm W 28cm

DIV-MIA0294

Divano Miami in pelle
Categoria 1 - 190 x 109



DIV-MIA0295

Divano Miami in pelle
Categoria 2 - 190 x 109



DIV-MIA0296

Divano Miami in pelle
Categoria 3 - 190 x 109



W 298cm x D (102-165)cm x H 91cm
Seat H 38cm x D 58cm - Arm H 50cm - 2 pieces

DIV-FIL0321

Divano Filadelfia SX
Categoria 1 - 298 x 165



DIV-FIL0322

Divano Filadelfia SX
Categoria 2 - 298 x 165



DIV-FIL0323

Divano Filadelfia SX
Categoria 3 - 298 x 165





W 298cm x D (102-165)cm x H 91cm
 Seat H 38cm x D 58cm - Arm H 50cm - 2 pieces

DIV-FIL0324

Divano Filadelfia DX

Categoria 1 - 298 x 165



DIV-FIL0325

Divano Filadelfia DX

Categoria 2 - 298 x 165



DIV-FIL0326

Divano Filadelfia DX

Categoria 3 - 298 x 165



W 299cm x D (102-299)cm x H 91cm
 Seat H 38cm x D 58cm - Arm H 50cm - 3 pieces

DIV-FIL0264

Divano Filadelfia Angolo

Categoria 1 - 299 x 299



DIV-FIL0265

Divano Filadelfia Angolo

Categoria 2 - 299 x 299



DIV-FIL0266

Divano Filadelfia Angolo

Categoria 3 - 299 x 299



W 299cm x D (102-208)cm x H 91cm
 Seat H 38cm x D 58cm - Arm H 50cm - 3 pieces

DIV-FIL0267

Divano Filadelfia SX

Categoria 1 - 299 x 208



DIV-FIL0268

Divano Filadelfia SX

Categoria 2 - 299 x 208



DIV-FIL0269

Divano Filadelfia SX

Categoria 3 - 299 x 208



W 299cm x D (102-208)cm x H 91cm
 Seat H 38cm x D 58cm - Arm H 50cm - 3 pieces

DIV-FIL0270

Divano Filadelfia DX

Categoria 1 - 299 x 208



DIV-FIL0271

Divano Filadelfia DX

Categoria 2 - 299 x 208



DIV-FIL0272

Divano Filadelfia DX

Categoria 3 - 299 x 208





W 235cm x D 102cm x H 91cm
Seat H 38cm x D 58cm - Arm H 50cm

DIV-FIL0249

Divano Filadelfia

Categoria 1 - 235 x 102



DIV-FIL0250

Divano Filadelfia

Categoria 2 - 235 x 102



DIV-FIL0251

Divano Filadelfia

Categoria 3 - 235 x 102



W 207cm x D 102cm x H 91cm
Seat H 38cm x D 58cm - Arm H 50cm

DIV-FIL0261

Divano Filadelfia

Categoria 1 - 207 x 102



DIV-FIL0262

Divano Filadelfia

Categoria 2 - 207 x 102



DIV-FIL0263

Divano Filadelfia

Categoria 3 - 207 x 102



W 187cm x D 102cm x H 91cm
Seat H 38cm x D 58cm - Arm H 50cm

DIV-FIL0288

Divano Filadelfia

Categoria 1 - 187 x 102



DIV-FIL0289

Divano Filadelfia

Categoria 2 - 187 x 102



DIV-FIL0290

Divano Filadelfia

Categoria 3 - 187 x 102



W 304cm x D (107-170)cm x H (76-98)cm
Seat H 43cm x D 54cm - 2 pieces

DIV-DEN0327

Divano Denver SX

Categoria 1 - 304 x 170



DIV-DEN0328

Divano Denver SX

Categoria 2 - 304 x 170





















DIV-DEN0329

Divano Denver SX

Categoria 3 - 304 x 170



 <p>W 304cm x D (107-170)cm x H (76-98)cm Seat H 43cm x D 54cm - 2 pieces</p>	<p>DIV-DEN0330 Divano Denver DX Categoria 1 - 304 x 170</p> 
	<p>DIV-DEN0331 Divano Denver DX Categoria 2 - 304 x 170</p> 
	<p>DIV-DEN0332 Divano Denver DX Categoria 3 - 304 x 170</p> 
 <p>W 236cm x D 107cm x H (76-98)cm Seat H 43cm x D 54cm</p>	<p>DIV-DEN0252 Divano Denver Categoria 1 - 236 x 107</p> 
	<p>DIV-DEN0253 Divano Denver Categoria 2 - 236 x 107</p> 
 <p>W 220cm x D 107cm x H (76-98)cm Seat H 43cm x D 54cm</p>	<p>DIV-DEN0285 Divano Denver Categoria 1 - 220 x 107</p> 
 <p>W 220cm x D 107cm x H (76-98)cm Seat H 43cm x D 54cm</p>	<p>DIV-DEN0286 Divano Denver Categoria 2 - 220 x 107</p> 
 <p>W 220cm x D 107cm x H (76-98)cm Seat H 43cm x D 54cm</p>	<p>DIV-DEN0287 Divano Denver Categoria 3 - 220 x 107</p> 
 <p>W 200cm x D 107cm x H (76-98)cm Seat H 43cm x D 54cm</p>	<p>DIV-DEN0291 Divano Denver Categoria 1 - 200 x 107</p> 
 <p>W 200cm x D 107cm x H (76-98)cm Seat H 43cm x D 54cm</p>	<p>DIV-DEN0292 Divano Denver Categoria 2 - 200 x 107</p> 
 <p>W 200cm x D 107cm x H (76-98)cm Seat H 43cm x D 54cm</p>	<p>DIV-DEN0293 Divano Denver Categoria 3 - 200 x 107</p> 



W 325cm x D (100-160)cm x H 82cm
Seat H 43cm - 2 pieces

DIV-LIV0273

Divano Liverpool SX
Categoria 1 - 325 x 160



DIV-LIV0274

Divano Liverpool SX
Categoria 2 - 325 x 160



DIV-LIV0275

Divano Liverpool SX
Categoria 3 - 325 x 160



W 325cm x D (100-160)cm x H 82cm
Seat H 43cm - 2 pieces

DIV-LIV0255

Divano Liverpool DX
Categoria 1 - 325 x 160



DIV-LIV0256

Divano Liverpool DX
Categoria 2 - 325 x 160



DIV-LIV0257

Divano Liverpool DX
Categoria 3 - 325 x 160



W 240cm x D 100cm x H 82cm
Seat H 43cm

DIV-LIV0243

Divano Liverpool
Categoria 1 - 240 x 100



DIV-LIV0244

Divano Liverpool
Categoria 2 - 240 x 100



DIV-LIV0245

Divano Liverpool
Categoria 3 - 240 x 100



W 220cm x D 100cm x H 82cm
Seat H 43cm

DIV-LIV0297

Divano Liverpool
Categoria 1 - 220 x 100



DIV-LIV0298

Divano Liverpool
Categoria 2 - 220 x 100



DIV-LIV0299

Divano Liverpool
Categoria 3 - 220 x 100





W 190cm x D 100cm x H 82cm
Seat H 43cm

DIV-LIV0300

Divano Liverpool

Categoria 1 - 190 x 100



DIV-LIV0301

Divano Liverpool

Categoria 2 - 190 x 100



DIV-LIV0302

Divano Liverpool

Categoria 3 - 190 x 100



W 242cm x D 104cm x H 75cm
H 38cm x D 56cm



DIV-OVE0318

Divano Over in pelle

Categoria 1- 242x104 h75



DIV-OVE0319

Divano Over in pelle

Categoria 2- 242x104 h75



DIV-OVE0320

Divano Over in pelle

Categoria 3- 242x104 h75



W 240cm x D 110cm x H (75-110)cm
Seat H 35cm x D 65cm

DIV-SCO0303

Divano Scorpion in pelle

Categoria 1- 240x110 h75



DIV-SCO0304

Divano Scorpion in pelle

Categoria 2- 240x110 h75



DIV-SCO0305

Divano Scorpion in pelle

Categoria 3- 240x110 h75



W 240cm x D 103cm x H 78cm
Seat H 39cm x D 58cm

DIV-BEL0173

Divano Belfast in pelle

Categoria 1 - 240 x 103



DIV-BEL0177

Divano Belfast in pelle

Categoria 2 - 240 x 103



DIV-BEL0176

Divano Belfast in pelle

Categoria 3 - 240 x 103





W 220cm x D 103cm x H 78cm
Seat H 39cm x D 58cm

DIV-BEL0191

Divano Belfast in pelle
Categoria 1 - 220 x 103



DIV-BEL0192

Divano Belfast in pelle
Categoria 2 - 220 x 103



DIV-BEL0193

Divano Belfast in pelle
Categoria 3 - 220 x 103



W 200cm x D 103cm x H 78cm
Seat H 39cm x D 58cm

DIV-BEL0194

Divano Belfast in pelle
Categoria 1 - 200 x 103



DIV-BEL0195

Divano Belfast in pelle
Categoria 2 - 200 x 103



DIV-BEL0196

Divano Belfast in pelle
Categoria 3 - 200 x 103



W 180cm x D 103cm x H 78cm
Seat H 39cm x D 58cm

DIV-BEL0197

Divano Belfast in pelle
Categoria 1 - 180 x 103



DIV-BEL0198

Divano Belfast in pelle
Categoria 2 - 180 x 103



DIV-BEL0199

Divano Belfast in pelle
Categoria 3 - 180 x 103

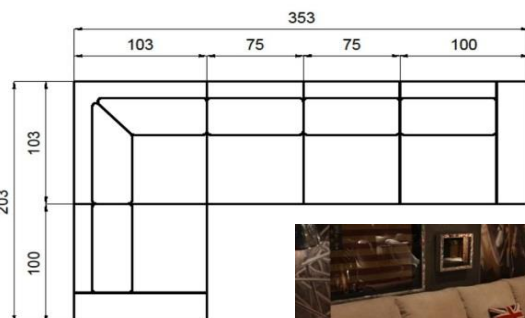

DIV-BEL0200

Divano Belfast in pelle
Categoria 1 - 353 x 203



DIV-BEL0201

Divano Belfast in pelle
Categoria 2 - 353 x 203



DIV-BEL0202

Divano Belfast in pelle
Categoria 3 - 353 x 203



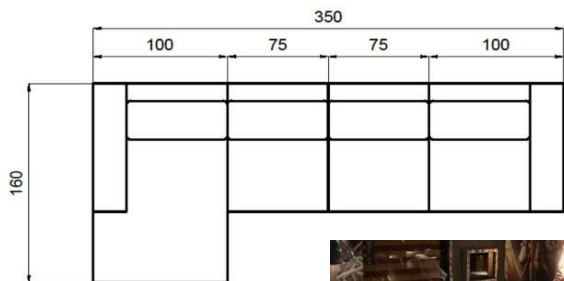

DIV-BEL0203

Divano Belfast sx in pelle

Categoria 1 - 350 x 160



DIV-BEL0204

Divano Belfast sx in pelle

Categoria 2 - 350 x 160



DIV-BEL0205

Divano Belfast sx in pelle

Categoria 3 - 350 x 160

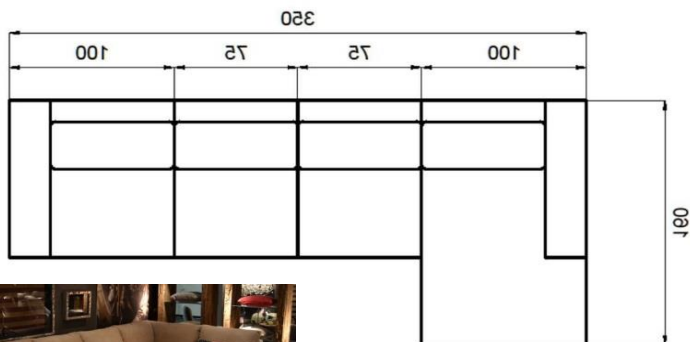

DIV-BEL0206

Divano Belfast dx in pelle

Categoria 1 - 350 x 160



DIV-BEL0207

Divano Belfast dx in pelle

Categoria 2 - 350 x 160



DIV-BEL0208

Divano Belfast dx in pelle

Categoria 3 - 350 x 160



W 94cm x D 70cm x H 39cm

POG-BEL0055

Poggiapiedi Belfast in pelle

Categoria 1 - 94 x 70



POG-BEL0056

Poggiapiedi Belfast in pelle

Categoria 2 - 94 x 70



POG-BEL0053

Poggiapiedi Belfast in pelle

Categoria 3 - 94 x 70



W 290cm x D (98-160)cm x H 75cm
Seat H 42cm x D 62cm

DIV-NOR0174

Divano Norwik in pelle SX

Categoria 1 - 290x160



DIV-NOR0181

Divano Norwik in pelle SX

Categoria 2 - 290x160



DIV-NOR0182

Divano Norwik in pelle SX

Categoria 3 - 290x160





W 290cm x D (98-160)cm x H 75cm
Seat H 42cm x D 62cm

DIV-NOR0282

Divano Norwik in pelle DX

Categoria 1 - 290x160



DIV-NOR0283

Divano Norwik in pelle DX

Categoria 2 - 290x160



DIV-NOR0284

Divano Norwik in pelle DX

Categoria 3 - 290x160



W 245cm x D 98cm x H 75cm
Seat H 42cm x D 62cm

DIV-NOR0209

Divano Norwik in pelle

Categoria 1 - 245



DIV-NOR0210

Divano Norwik in pelle

Categoria 2 - 245



DIV-NOR0211

Divano Norwik in pelle

Categoria 3 - 245



W 225cm x D 98cm x H 75cm
Seat H 42cm x D 62cm

DIV-NOR0212

Divano Norwik in pelle

Categoria 1 - 225



DIV-NOR0213

Divano Norwik in pelle

Categoria 2 - 225



DIV-NOR0214

Divano Norwik in pelle

Categoria 3 - 225



W 200cm x D 98cm x H 75cm
Seat H 42cm x D 62cm

DIV-NOR0215

Divano Norwik in pelle

Categoria 1 - 200



DIV-NOR0216

Divano Norwik in pelle

Categoria 2 - 200



DIV-NOR0217

Divano Norwik in pelle

Categoria 3 - 200





W 175cm x D 98cm x H 75cm
Seat H 42cm x D 62cm

DIV-NOR0218

Divano Norwik in pelle

Categoria 1 - 175



DIV-NOR0219

Divano Norwik in pelle

Categoria 2 - 175

















DIV-NOR0220

















Divano Norwik in pelle

Categoria 3 - 175



Sedie - Chairs

















 <p>W 62cm x D 65cm x H 80cm Seat H 46cm - Arm H 65cm - Weight 11kg</p>	<p>SED-MAR0172 Sedia Marty in pelle categoria 1</p> 
 <p>W 62cm x D 65cm x H 80cm Seat H 46cm - Arm H 65cm - Weight 12kg</p>	<p>SED-MAR0175 Sedia Marty in pelle categoria 1</p> 
 <p>W 62cm x D 65cm x H 80cm Seat H 46cm - Arm H 65cm - Weight 12,5kg</p>	<p>SED-MAR0176 Sedia Marty in pelle categoria 2</p> 
 <p>W 62cm x D 65cm x H 80cm Seat H 46cm - Arm H 65cm - Weight 10kg</p>	<p>SED-MAR0177 Sedia Marty in pelle categoria 3</p> 
	<p>SED-MAR0178 Sedia Marty in pelle categoria 1</p> 
	<p>SED-MAR0179 Sedia Marty in pelle categoria 2</p> 
	<p>SED-MAR0180 Sedia Marty in pelle categoria 3</p> 
	<p>SED-MAR0181 Sedia Marty in pelle categoria 1</p> 
	<p>SED-MAR0182 Sedia Marty in pelle categoria 2</p> 
	<p>SED-MAR0183 Sedia Marty in pelle categoria 3</p> 

















 <p>W 62cm x D 65cm x H 80cm Seat H 46cm - Arm H 65cm</p>	<p>SED-MAR0184 Sedia Marty in pelle categoria 1</p>  <p>SED-MAR0185 Sedia Marty in pelle categoria 2</p>  <p>SED-MAR0186 Sedia Marty in pelle categoria 3</p> 
 <p>W 62cm x D 65cm x H (78-86)cm Seat H (41-49)cm - Arm H (60-68)cm</p>	<p>SED-MAR0187 Sedia Marty in pelle categoria 1</p>  <p>SED-MAR0188 Sedia Marty in pelle categoria 2</p>  <p>SED-MAR0189 Sedia Marty in pelle categoria 3</p> 
 <p>W 62cm x D 65cm x H 80cm Seat H 46cm - Arm H 65cm</p>	<p>SED-MAR0190 Sedia Marty in pelle categoria 1</p>  <p>SED-MAR0191 Sedia Marty in pelle categoria 2</p>  <p>SED-MAR0192 Sedia Marty in pelle categoria 3</p> 
 <p>W 62cm x D 65cm x H (94-120)cm Seat H (60-86)cm - Arm H (74-98)cm</p>	<p>SED-BAR0193 Sgabello Bar Marty in pelle categoria 1</p>  <p>SED-BAR0194 Sgabello Bar Marty in pelle categoria 2</p>  <p>SED-BAR0195 Sgabello Bar Marty in pelle categoria 3</p> 

 <p>W 64cm x D 64cm x H 81cm Seat H 46cm</p>	<p>SED-ARI0089 Sedia Arianne in pelle categoria 1</p>  <p>SED-ARI0090 Sedia Arianne in pelle categoria 2</p>  <p>SED-ARI0091 Sedia Arianne in pelle categoria 3</p> 
 <p>W 64cm x D 64cm x H 81cm Seat H 46cm</p>	<p>SED-ARI0064 Sedia Arianne in pelle categoria 1</p>  <p>SED-ARI0065 Sedia Arianne in pelle categoria 2</p>  <p>SED-ARI0092 Sedia Arianne in pelle categoria 3</p> 
 <p>W 64cm x D 64cm x H 81cm Seat H 46cm</p>	<p>SED-ARI0058 Sedia Arianne in pelle categoria 1</p>  <p>SED-ARI0059 Sedia Arianne in pelle categoria 2</p>  <p>SED-ARI0088 Sedia Arianne in pelle categoria 3</p> 
 <p>W 64cm x D 64cm x H 81cm Seat H 46cm</p>	<p>SED-ARI0093 Sedia Arianne in pelle categoria 1</p>  <p>SED-ARI0094 Sedia Arianne in pelle categoria 2</p>  <p>SED-ARI0095 Sedia Arianne in pelle categoria 3</p> 

 <p>W 64cm x D 64cm x H 81cm Seat H 46cm - Weight 14kg</p>	<p>SED-ARI0036 Sedia Arianne in pelle categoria 1</p> 
	<p>SED-ARI0037 Sedia Arianne in pelle categoria 2</p> 
	<p>SED-ARI0096 Sedia Arianne in pelle categoria 3</p> 
 <p>W 64cm x D 64cm x H (78-86)cm Seat H (41-49)cm - Arm H (60-68)cm - Weight 12kg</p>	<p>SED-ARI0097 Sedia Arianne in pelle categoria 1</p> 
	<p>SED-ARI0098 Sedia Arianne in pelle categoria 2</p> 
	<p>SED-ARI0099 Sedia Arianne in pelle categoria 3</p> 
 <p>W 64cm x D 64cm x H 81cm Seat H 46cm - Weight 21kg</p>	<p>SED-ARI0100 Sedia Arianne in pelle categoria 1</p> 
	<p>SED-ARI0101 Sedia Arianne in pelle categoria 2</p> 
	<p>SED-ARI0102 Sedia Arianne in pelle categoria 3</p> 
 <p>W 64cm x D 64cm x H (95-121)cm Seat H (60-86)cm - Weight 12kg</p>	<p>SED-BAR0045 Sgabello Bar Arianne in pelle categoria 1</p> 
	<p>SED-BAR0046 Sgabello Bar Arianne in pelle categoria 2</p> 
	<p>SED-BAR0103 Sgabello Bar Arianne in pelle categoria 3</p> 

 <p>W 61cm x D 61cm x H 83cm Seat H 46cm - Arm H 61cm</p>	<p>SED-BET0067 Sedia Beth in pelle categoria 1</p>  <p>SED-BET0068 Sedia Beth in pelle categoria 2</p>  <p>SED-BET0069 Sedia Beth in pelle categoria 3</p> 
 <p>W 61cm x D 61cm x H 83cm Seat H 46cm - Arm H 61cm</p>	<p>SED-BET0070 Sedia Beth in pelle categoria 1</p>  <p>SED-BET0071 Sedia Beth in pelle categoria 2</p>  <p>SED-BET0072 Sedia Beth in pelle categoria 3</p> 
 <p>W 61cm x D 61cm x H 83cm Seat H 46cm - Arm H 61cm</p>	<p>SED-BET0073 Sedia Beth in pelle categoria 1</p>  <p>SED-BET0074 Sedia Beth in pelle categoria 2</p>  <p>SED-BET0075 Sedia Beth in pelle categoria 3</p> 
  <p>W 61cm x D 61cm x H 83cm Seat H 46cm - Arm H 61cm</p>	<p>SED-BET0057 Sedia Beth in pelle categoria 1</p>  <p>SED-BET0063 Sedia Beth in pelle categoria 2</p>  <p>SED-BET0066 Sedia Beth in pelle categoria 2</p> 

 <p>W 61cm x D 61cm x H 83cm Seat H 46cm - Arm H 61cm</p>	<p>SED-BET0076 Sedia Beth in pelle categoria 1</p> 
	<p>SED-BET0077 Sedia Beth in pelle categoria 2</p> 
	<p>SED-BET0078 Sedia Beth in pelle categoria 3</p> 
 <p>W 61cm x D 61cm x H (75-83)cm Seat H (42-50)cm - Arm H (56-65)cm</p>	<p>SED-BET0079 Sedia Beth in pelle categoria 1</p> 
	<p>SED-BET0080 Sedia Beth in pelle categoria 2</p> 
	<p>SED-BET0081 Sedia Beth in pelle categoria 3</p> 
 <p>W 61cm x D 61cm x H 83cm Seat H 46cm - Arm H 61cm</p>	<p>SED-BET0082 Sedia Beth in pelle categoria 1</p> 
	<p>SED-BET0083 Sedia Beth in pelle categoria 2</p> 
	<p>SED-BET0084 Sedia Beth in pelle categoria 3</p> 
 <p>W 61cm x D 61cm x H (80-106)cm Seat H (50-76)cm</p>	<p>SED-BAR0085 Sgabello Bar Beth in pelle categoria 1</p> 
	<p>SED-BAR0086 Sgabello Bar Beth in pelle categoria 2</p> 
	<p>SED-BAR0087 Sgabello Bar Beth in pelle categoria 3</p> 

 <p>W 65cm x D 60cm x H 82cm Seat H 45cm - Arm H 62cm</p>	<p>SED-CON0105 Sedia Conny in pelle categoria 1</p>  <p>SED-CON0106 Sedia Conny in pelle categoria 2</p>  <p>SED-CON0107 Sedia Conny in pelle categoria 3</p> 
 <p>W 65cm x D 60cm x H 82cm Seat H 45cm - Arm H 62cm</p>	<p>SED-CON0108 Sedia Conny in pelle categoria 1</p>  <p>SED-CON0109 Sedia Conny in pelle categoria 2</p>  <p>SED-CON0110 Sedia Conny in pelle categoria 3</p> 
 <p>W 65cm x D 60cm x H 82cm Seat H 45cm - Arm H 62cm</p>	<p>SED-CON0111 Sedia Conny in pelle categoria 1</p>  <p>SED-CON0112 Sedia Conny in pelle categoria 2</p>  <p>SED-CON0113 Sedia Conny in pelle categoria 3</p> 
 <p>W 65cm x D 60cm x H 82cm Seat H 45cm - Arm H 62cm</p>	<p>SED-CON0114 Sedia Conny in pelle categoria 1</p>  <p>SED-CON0115 Sedia Conny in pelle categoria 2</p>  <p>SED-CON0116 Sedia Conny in pelle categoria 3</p> 

 <p>W 65cm x D 60cm x H 82cm Seat H 45cm - Arm H 62cm - Weight 13kg</p>	<p>SED-CON0117 Sedia Conny in pelle categoria 1</p> 
 <p>W 65cm x D 60cm x H (78-86)cm Seat H (41-49)cm - Arm H (58-66)cm - Weight 10kg</p>	<p>SED-CON0038 Sedia Conny in pelle categoria 1</p> 
 <p>W 65cm x D 60cm x H 82cm Seat H 45cm - Arm H 62cm - Weight 20kg</p>	<p>SED-CON0120 Sedia Conny in pelle categoria 1</p> 
 <p>W 65cm x D 60cm x H (96-122)cm Seat H (60-86)cm - Arm H (77-103)cm - Weight 22kg</p>	<p>SED-BAR0047 Sgabello Bar Conny in pelle categoria 1</p> 
<p>SED-BAR0048 Sgabello Bar Conny in pelle categoria 2</p> 	<p>SED-BAR0123 Sgabello Bar Conny in pelle categoria 3</p> 

 <p>W 62cm x D 60cm x H 79cm Seat H 46cm - Arm H 61cm</p>	<p>SED-JEN0126 Sedia Jenny in pelle categoria 1</p>  <p>SED-JEN0127 Sedia Jenny in pelle categoria 2</p>  <p>SED-JEN0128 Sedia Jenny in pelle categoria 3</p> 
 <p>W 62cm x D 60cm x H 79cm Seat H 46cm - Arm H 61cm</p>	<p>SED-JEN0129 Sedia Jenny in pelle categoria 1</p>  <p>SED-JEN0130 Sedia Jenny in pelle categoria 2</p>  <p>SED-JEN0131 Sedia Jenny in pelle categoria 3</p> 
 <p>W 62cm x D 60cm x H 79cm Seat H 46cm - Arm H 61cm</p>	<p>SED-JEN0042 Sedia Jenny in pelle categoria 1</p>  <p>SED-JEN0043 Sedia Jenny in pelle categoria 2</p>  <p>SED-JEN0124 Sedia Jenny in pelle categoria 3</p> 
 <p>W 62cm x D 60cm x H 79cm Seat H 46cm - Arm H 61cm</p>	<p>SED-JEN0132 Sedia Jenny in pelle categoria 1</p>  <p>SED-JEN0133 Sedia Jenny in pelle categoria 2</p>  <p>SED-JEN0134 Sedia Jenny in pelle categoria 3</p> 

 <p>W 62cm x D 60cm x H 79cm Seat H 46cm - Arm H 61cm</p>	<p>SED-JEN0135 Sedia Jenny in pelle categoria 1</p>  <p>SED-JEN0136 Sedia Jenny in pelle categoria 2</p>  <p>SED-JEN0137 Sedia Jenny in pelle categoria 3</p> 
 <p>W 62cm x D 60cm x H (77-85)cm Seat H (42-50)cm - Arm H (59-67)cm</p>	<p>SED-JEN0138 Sedia Jenny in pelle categoria 1</p>  <p>SED-JEN0139 Sedia Jenny in pelle categoria 2</p>  <p>SED-JEN0140 Sedia Jenny in pelle categoria 3</p> 
 <p>W 62cm x D 60cm x H 79cm Seat H 46cm - Arm H 61cm</p>	<p>SED-JEN0141 Sedia Jenny in pelle categoria 1</p>  <p>SED-JEN0142 Sedia Jenny in pelle categoria 2</p>  <p>SED-JEN0143 Sedia Jenny in pelle categoria 3</p> 
  <p>W 62cm x D 60cm x H (93-119)cm Seat H (60-86)cm - Arm H (75-101)cm</p>	<p>SED-BAR0051 Sgabello Bar Jenny in pelle categoria 1</p>  <p>SED-BAR0052 Sgabello Bar Jenny in pelle categoria 2</p>  <p>SED-BAR0125 Sgabello Bar Jenny in pelle categoria 3</p> 

 <p>W 53cm x D 58cm x H 81cm Seat H 46cm - Weight 11kg</p>	<p>SED-MEL0146 Sedia Melissa in pelle categoria 1 </p> <p>SED-MEL0147 Sedia Melissa in pelle categoria 2 </p> <p>SED-MEL0148 Sedia Melissa in pelle categoria 3 </p>
 <p>W 53cm x D 58cm x H 81cm Seat H 46cm - Weight 13kg</p>	<p>SED-MEL0149 Sedia Melissa in pelle categoria 1 </p> <p>SED-MEL0150 Sedia Melissa in pelle categoria 2 </p> <p>SED-MEL0151 Sedia Melissa in pelle categoria 3 </p>
 <p>W 53cm x D 58cm x H 81cm Seat H 46cm - Weight 8kg</p>	<p>SED-MEL0049 Sedia Melissa in pelle categoria 1 </p> <p>SED-MEL0050 Sedia Melissa in pelle categoria 2 </p> <p>SED-MEL0144 Sedia Melissa in pelle categoria 3 </p>
 <p>W 53cm x D 58cm x H 81cm Seat H 46cm - Weight 10kg</p>	<p>SED-MEL0152 Sedia Melissa in pelle categoria 1 </p> <p>SED-MEL0153 Sedia Melissa in pelle categoria 2 </p> <p>SED-MEL0154 Sedia Melissa in pelle categoria 3 </p>

 <p>W 53cm x D 58cm x H 81cm Seat H 46cm - Weight 14kg</p>	<p>SED-MEL0155 Sedia Melissa in pelle categoria 1</p> 
	<p>SED-MEL0156 Sedia Melissa in pelle categoria 2</p> 
	<p>SED-MEL0157 Sedia Melissa in pelle categoria 3</p> 
 <p>W 53cm x D 58cm x H (79-87)cm Seat H (44-52)cm - Weight 11kg</p>	<p>SED-MEL0158 Sedia Melissa in pelle categoria 1</p> 
	<p>SED-MEL0159 Sedia Melissa in pelle categoria 2</p> 
	<p>SED-MEL0160 Sedia Melissa in pelle categoria 3</p> 
 <p>W 53cm x D 58cm x H 81cm Seat H 46cm - Weight 20kg</p>	<p>SED-MEL0161 Sedia Melissa in pelle categoria 1</p> 
	<p>SED-MEL0162 Sedia Melissa in pelle categoria 2</p> 
	<p>SED-MEL0163 Sedia Melissa in pelle categoria 3</p> 
 <p>W 53cm x D 58cm x H (94-120)cm Seat H (60-86)cm - Weight 23kg</p>	<p>SED-BAR0053 Sgabello Bar Melissa in pelle categoria 1</p> 
	<p>SED-BAR0054 Sgabello Bar Melissa in pelle categoria 2</p> 
	<p>SED-BAR0145 Sgabello Bar Melissa in pelle categoria 3</p> 

 <p>W 44cm x D 54cm x H 89cm Seat H 45cm - Weight 9kg</p>	<p>SED-CAT0165 Sedia Catrina in pelle categoria 1</p> 
	<p>SED-CAT0166 Sedia Catrina in pelle categoria 2</p> 
	<p>SED-CAT0167 Sedia Catrina in pelle categoria 3</p> 
 <p>W 44cm x D 54cm x H 89cm Seat H 45cm - Weight 8kg</p>	<p>SED-CAT0056 Sedia Catrina in pelle categoria 1</p> 
	<p>SED-CAT0061 Sedia Catrina in pelle categoria 2</p> 
	<p>SED-CAT0164 Sedia Catrina in pelle categoria 3</p> 
 <p>W 44cm x D 54cm x H (85-93)cm Seat H (43-51)cm - Weight 9kg</p>	<p>SED-CAT0168 Sedia Catrina in pelle categoria 1</p> 
	<p>SED-CAT0169 Sedia Catrina in pelle categoria 2</p> 
	<p>SED-CAT0170 Sedia Catrina in pelle categoria 3</p> 
 <p>W 44cm x D 54cm x H (87-112)cm Seat H (57-82)cm - Weight 21kg</p>	<p>SED-BAR0055 Sgabello Bar Catrina in pelle categoria 1</p> 
	<p>SED-BAR0062 Sgabello Bar Catrina in pelle categoria 2</p> 
	<p>SED-BAR0171 Sgabello Bar Catrina in pelle categoria 3</p> 



SED-BRI0060

Sedia Bristol in cuoio



Tavoli - Tables



TAV-ALL0082

Tavolo Slim 180x90xh75

Allungabile 180+45+45=270

Categoria TOP 6mm



Paliss / Briccole / noce / olivo
TRANCIATO SU ALVEOLARE



TAV-ALL0083

Tavolo Slim 180x90xh75

Allungabile 180+45+45=270

Categoria TOP 6mm



tutte le altre finiture campioni
LAMINATO SU ALVEOLARE

TAV-ALL0085

Tavolo Slim 180x90xh75

Allungabile 180+45+45=270

Categoria TOP 18mm



LAMINATO SU MDF

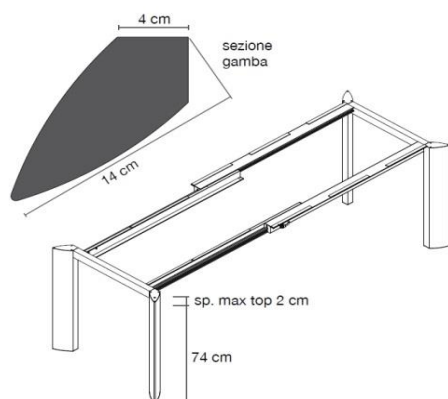

BASE SENZA TOP

TAV-ALL0100

Tavolo Slim 180x90xh75

Allungabile 180+45+45=270

Base tavolo senza top
incl. Kit velcro e istruzioni



larghezza 80cm

meno 3%

Lunghezza 160cm

meno 2%

Lunghezza 140cm

meno 4%



TAV-ALL0086

Tavolo Slim 180x90xh75

FISSO

Categoria TOP 6mm



Paliss / Briccole / noce / olivo
TRANCIATO SU ALVEOLARE

TAV-ALL0087

Tavolo Slim 180x90xh75

FISSO

Categoria

TOP 6mm



tutte le altre finiture campioni
LAMINATO SU ALVEOLARE

TAV-ALL0088

Tavolo Slim 180x90xh75

FISSO

Categoria

TOP 16mm



tutte le altre finiture campioni
LAMINATO SU MDF

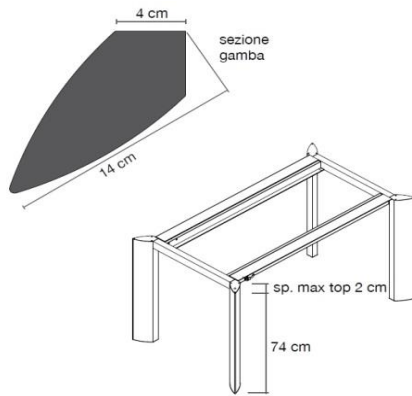

BASE SENZA TOP

TAV-ALL0101

Tavolo Slim 180x90xh75

FISSO

Base tavolo senza top
incl. Kit velcro e istruzioni



larghezza 80cm	meno 3%
Lunghezza 160cm	meno 2%
Lunghezza 140cm	meno 4%

	<p>TAV-KIN0098 Tavolo King</p> 
	<p>TAV-DAY0097 Tavolo Dayton (set of 3 pcs)</p> 
	<p>TAV-OKL0099 Tavolo Oklahoma</p> 
	<p>TAV-MIC0094 Tavolo Michigan in ferro/legno/vetro 85 x 85 x h 40</p> 
	<p>TAV-DAR0093 Tavolo Darwin in ferro/pelle 80 x 80 x h 30</p> 
	<p>TAV-DAR0096 Tavolo Darwin in ferro/pelle 55 x 46 x h 50</p> 
<p>Cuscini - Cushions</p>	
 <p data-bbox="371 2045 762 2078">Fiberfill poliestere e piuma d'oca</p>	<p>COM-CUS0211 Cuscino in pelle 45x45 categoria 1</p> 
	<p>COM-CUS0216 Cuscino in pelle 45x45 categoria 2</p> 
	<p>COM-CUS0215 Cuscino in Tessuto 45x45 categoria 3</p> 



COM-LAM0218
 Lampadario Shape in mat.
 composito alluminio/rame
 88 x 88 x h 72





COM-LAM0217
 Lampadario Shape in mat.
 composito alluminio
 88 x 88 x h 72





COM-LAM0224
 Lampadario Shape in mat.
 composito alluminio/rame
 88 x 88 x h 28















COM-LAM0223
 Lampadario Shape in mat.
 composito alluminio
 88 x 88 x h 28

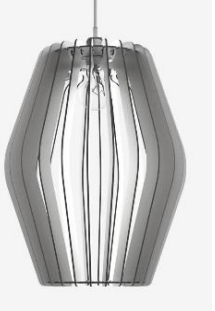

COM-LAM0226
 Lampadario Shape in mat.
 composito alluminio/rame
 52 x 52 x h 28

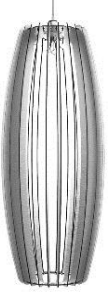

COM-LAM0225
 Lampadario Shape in mat.
 composito alluminio
 52 x 52 x h 28

	<p>COM-LAM0228 Lampadario Shape in mat. composito alluminio/rame 32 x 32 x h 45</p> 
	<p>COM-LAM0227 Lampadario Shape in mat. composito alluminio 32 x 32 x h 45</p> 
	<p>COM-LAM0222 Lampadario Shape in mat. composito alluminio/rame 30 x 30 x h 80</p> 
	<p>COM-LAM0221 Lampadario Shape in mat. composito alluminio 30 x 30 x h 80</p> 
	<p>COM-LAM0220 Lampadario Shape in mat. composito alluminio/rame 60 x 60 x h 60</p> 
	<p>COM-LAM0219 Lampadario Shape in mat. composito alluminio 60 x 60 x h 60</p> 