

OP EN DO OR

TWENTYFIRST
design from a new century

21ST
LIVINGART



OP

EN

DO

OR

TWENTYFIRST

design from a new century

Mario
Mazzer



Nasce nel 1955. Nel '78 si laurea in architettura al Politecnico di Milano e nel '79 in industrial design. Collabora con i maestri Achille Castiglioni e Marco Zanuso. Partecipa a convegni e conferenze ed espone in musei e mostre di design. Ha ricevuto menzioni speciali nel '88 e nel '89 al concorso Young & Design, che ha vinto nel '91. Nel 1996 riceve una menzione d'onore ID Annual Design Review. I suoi prodotti sono stati selezionati più volte nell'ADI Design Index e nell'International Design Yearbook. Nel 2001 esce la sua monografia a edita dalla Biblioteca dell'Immagine: Thinking about Things: Mario Mazzer designer. Nel 2006 e 2007 riceve la menzione speciale al Concorso Riabita. Riceve il Good Design 2009 per OLA / Martex che vince anche il Red Dot 2010. In questa edizione riceve inoltre, il premio per il caminetto TUBE / Acquaefuoco e per la tenda SHAN / Shadelab. Nel 2011 vince il Good Design con BABELE di Bonaldo. Collabora o ha collaborato con le più importanti aziende dell'arredo. E' membro ADI e BEDA. Nell'architettura restaura o progetta edifici residenziali, commerciali, direzionali sia in Italia sia all'estero. I suoi progetti sono continuamente pubblicati in numerose riviste internazionali.

Born in 1955, Mario Mazzer received his degree in Architecture from the Politecnico of Milan in 1978 and in Industrial Design in 1979. He collaborates with Maestri Achille Castiglioni and Marco Zanuso. Mazzer participates in conventions, conferences and exhibits in museums and design exhibitions. He received special mentions in 1988 and 1989 at the Young and Design contest, which he won in 1991. In 1996, he received the iD annual Design Review honourable mention. His new products have been selected many times by the ADI Design Index and the International Design Yearbook. In 2001, his monograph, "Thinking About Things: Mario Mazzer designer" was published by the Biblioteca dell'Immagine. In 2006 and 2007, he received a special mention at the Riabita competition. He received the 2009 Good Design award for OLA / Martex, which also won the 2010 Red Dot. During that edition he also received the award for the Tube / Acquaefuoco fi replace and for the Shan / Shadelab awning. In 2011 he won the Good Design award with Babele by Bonaldo. He works with or has worked with the most important furniture companies. Member of ADI and BeDa. He also restores or designs residences, commercial buildings, and management offices in Italy and abroad. His projects are continuously published in a variety of International magazines

Moredesign



Moredesign nasce a Padova nel 2006 realizzando il sogno nel cassetto di Alessandro Morello. Il team composto da Alessandro Morello e Riccardo

Bertolla senior industrial designer, Paola Zanovello fashion designer e consolidati collaboratori permette di affrontare importanti progetti di industrial design, rivolti ad un mercato globale capace di trasformare in stimolo quello che lo circonda. Accoglie con entusiasmo nuove sfide e interpreta le esigenze dell'individuo semplificando il rapporto tra uomo e oggetto perché "il design è di tutti". visualizza l'innovazione delle forme stringendo il binomio designer-azienda dando garanzia del risultato finale. Le molteplici esperienze in settori diversi dal giocattolo all'automotive, dagli sport invernali alla prima infanzia, dalla moda al complemento d'arredo, gli consente di seguire "ogni" tipologia di prodotto ed essere un ottimo partner in outsourcing per le aziende. Tappe significative: co-design con brand internazionali della calzatura e occhialeria, collabora con lo studio di architettura Gris partecipando attivamente al concept creativo per jet privati ed è ben inserito nel mondo dell'arredamento e illuminazione.

Alessandro Morello decided to make his own dreams come true by founding Moredesign in Padua in 2006. The team that was put together by Alessandro Morello and Riccardo Bertolla, senior Industrial Designer, Paola Zanovello, Fashion Designer, along with experienced collaborators allowed the new-found company to take on important industrial design projects for a global market, able to transform what surrounds us into a stimulus for new designs. The firm is enthused by new challenges and interprets individual needs by simplifying the relationship between man and object. Because "design is for everyone". It visualizes innovation of shapes by first strengthening the designer-company bond, bringing about a true guarantee of final results. The many experiences in different industries, from toys to automotive, from winter sports to baby products, from fashion to furnishing complements, allows the company to be able to work with "any and every" product type and to be an excellent outsourcing partner for companies. Significant milestones: co-design with international shoe and eyewear brands. Collaborated with Gris architecture firm by participating in the creative concept for private jets. Very active in the world of furnishings and lighting.

S. THESIA PROGETTI



Nato negli anni Settanta come studio di architettura ed ingegneria, Studio Thesia Progetti ha allargato i propri orizzonti entrando in altri settori dell'attività creativa, occupandosi di progettazione d'interni ed allestimenti, attuando collaborazioni in Italia, Grecia, Arabia Saudita, Libia, Usa. Dal 1989 lo Studio si occupa anche di Industrial Design nell'accezione più vasta del termine, facendolo diventare una parte integrante della sua attività creativa e lavorando per aziende dei più diversi settori: dall'arredamento, al lighting design, all'oggettistica per la casa. I progetti dello Studio, pubblicati dalle più note riviste di settore, hanno avuto premi e riconoscimenti a concorsi e mostre. Dal '96 è consulente e art director di numerose aziende del product design per le quali cura anche la progettazione degli spazi espositivi e dell'immagine coordinata. Da alcuni anni si

occupa anche di management design attraverso la coordinazione dei numerosi soggetti che necessariamente devono interagire per un ottimale sviluppo di un progetto di successo.

Founded in the 1970s as an architecture and engineering firm, Studio Thesia Progetti has broadened its horizons by entering into the creative sector. The company works on interior design projects as well as exhibition stands, and collaborates in Italy, Greece, Saudi Arabia, Libya, and the USA. Since 1989, the studio has also been involved in Industrial Design, in the vastest sense of the term. It has become an integral part of the firm's creative activities, working with companies in various industries: from furnishings to lighting design to household articles. The studio's designs, published by the most noted industry magazines, have received awards and recognition at competitions and exhibits. Since 1996, the studio has served as consultant and art director for numerous product design companies, taking on projects that range from designing exhibition stands to developing a coordinated brand image. The studio has also been involved with design management, coordinating the many subjects that are necessary during a project, facilitating the interaction of numerous people in order to successfully bring a design to conclusion.

Italo
Pertichini



Italo Pertichini nasce a Gebenstorf in Svizzera nel 1964. La sua formazione artistica presso l'istituto d'arte di San Giovanni in Fiore (CS) e tecnico-estetica presso l'ISIA di Roma è alla base della sua attività di designer. Dopo varie esperienze professionali, nel 2001 apre lo studio di progettazione a Milano occupandosi di industrial design e interior design. Nel 2005 vince il primo premio al concorso internazionale indetto da AIPE "Nuovi imballaggi in EPS". Dal 1996 è socio ADI.

Italo Pertichini was born in Gebenstorf, Switzerland, in 1964. His work as a designer has been influenced by his education at the art school of San Giovanni in Fiore in Cosenza and as a beauty technician at the Higher Institute of Industrial Arts (ISIA) in Rome. After various professional experiences, in 2001 he opened his design studio in Milan and began to focus on industrial design and interior design. In 2005 he won first prize in the international competition "New EPS Packaging" organised by the Italian Association for Expanded Polystyrene (AIPE). He has been a member of the Industrial Design Association (ADI) since 1996.

Marco
Cocco



Marco Cocco nasce a Campobasso nel 1974, si laurea in Disegno Industriale al Politecnico di Milano e, dal 2000, inizia a collaborare con diversi studi milanesi di architettura e design, occupandosi di arredamento, oggettistica, allestimento e grafica per diverse aziende italiane e straniere. Nel 2007 apre il suo studio a Milano avviando l'attività di progettazione per l'industrial design e iniziando a collaborare con le aziende Caimi Brevetti, Estempore, Klab Design, Reflex e Twentyfirst.

Marco Cocco was born in Campobasso in 1974. He has a degree in Industrial Design from the Politecnico di Milano, and in 2000 he started collaborating with many architecture and design firms in Milan. He works on décor, household articles, exhibition stands, and graphics for many Italian and foreign companies. In 2007 he opened his own studio in Milan as an Industrial Designer, and he continues to collaborate with Caimi Brevetti, Estempore, Klab Design, Reflex, and Twentyfirst.

Twentyfirst
Design lab



Creare uno studio di design all'interno di un'azienda è un progetto ambizioso. 21ST ha deciso di percorrere questa strada dando vita al "Twentyfirst design Lab", un laboratorio di idee applicate alla progettualità e alla produzione per coniugare le esigenze tecnico/funzionali con quelle estetiche, plasmare e dare vita a nuovi oggetti di design. L'intenzione del 21ST DESIGN LAB è quella di creare e soddisfare esigenze. Spesso il lavoro creativo è inibito dal fatto che i progettisti non possono seguire e controllare fino in fondo la fase di produzione. Il loro lavoro consiste nell'invenzione, ma la loro idea deve essere rapportata e riadattata alle esigenze produttive. 21ST si prende cura di questa problematica al fine di concepire oggetti che possono essere prodotti e riprodotti al meglio. Il progetto diviene parte integrante della produzione che assume il connotato di un alto artigianato. Un lavoro quotidiano fatto di ricerca e risultati. Progetti innovativi con qualità linguistiche inattese, dai quali scaturiscono oggetti destinati a rimanere nel tempo. 21ST sente la responsabilità della storia e tiene un atteggiamento di avanguardia fatto di ricerca, design e tecnologia. In questa chiave di lettura il 21st design lab non è solo un semplice laboratorio, ma è anche un veliero dove tecnici e designers sono marinai che si avventurano in mari aperti verso l'ignoto. Il suo scopo è quello di mettere in collegamento la creatività emozionale con la progettazione razionale, il desiderio con la soddisfazione, la fantasia con la realtà, l'estetica con la funzionalità. In sintesi: esplorare. "Twenty-

first" rappresenta un insieme di punti di approdo scoperti e segnati sulle nuove mappe dell'arte.

Creating a design studio within a company is an ambitious project. 21st decided to undertake this journey by creating the "Twentyfirst design Lab", a factory of ideas applied to design and production in order to unite technical and functional needs with aesthetic appearances, by moulding and creating new design objects. The aim of 21ST DESIGN LAB is to create and satisfy needs. Often creative projects are inhibited by the fact that designers cannot follow their projects right through to the end of the production process. Their job is limited to the invention phase, but their idea must be transferred and readapted to production requirements. 21st handles this issue by conceiving and creating objects that can be produced and reproduced in the best possible way. The project becomes an integral part of the production process that takes on the characteristics of a skilled craftsman. Constant research for results becomes a daily task. Innovative projects with unexpected linguistic qualities that generate objects destined to be around for a long time. 21st realises the importance of history and nurtures a modern outlook based on research, design and technology. With this in mind, 21st Design Lab is not just a straightforward laboratory, but rather a sailing boat upon which technicians and designers become sailors navigating in an open sea towards the unknown. Its aim is to connect emotional creativity with rational design, desire with satisfaction, fantasy with reality, beauty with functionality. In synthesis: the key word is explore. "Twentyfirst" represents a set of landing stages that have been discovered and marked on new artistic maps.

Graziano **Moro**
e Renato **Pigatti**



Loro immaginano, inventano e creano. Provano a cambiare le cose. Graziano Moro e Renato Pigatti realizzano quello che sono e dedicano il loro tempo a migliorare ed ideare, condividendo tra loro pensieri ed aspirazioni. La forte capacità comunicativa di Renato e la creatività di Graziano li portano ad esprimersi liberamente e con entusiasmo in ogni progetto che fanno. Due entità che si compensano e completano, nonostante il loro essere diversi. Certi che la creatività debba essere libera di spaziare ed essere applicata a qualsiasi oggetto ed esperienza del vivere, purché generi nuovi stimoli e porti con sé delle emozioni.

They imagine, invent and create. They try to change things around. Graziano Moro and Renato Pigatti create what they are and dedicate their time to improve and project, sharing between them thoughts and aspirations. The strong communication skills of Renato and the creativity of Graziano lead them to express themselves freely and enthusiastically in every project they do. Two entities that complete and balance each other out, despite their being different.

They are certain that creativity should be free to roam and be applied to any object and experience of life, provided it generates new ideas and brings emotion.

CrousCalogero

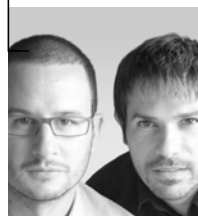

CrousCalogero è uno studio di design fondato nel 2009 da Francesco Crous e Alessandro Calogero dopo una esperienza maturata nell'arco di dieci anni al fianco di grandi designer e all'interno di grandi aziende internazionali. Così descrivono il loro lavoro: "Il nostro modo di lavorare è semplice: cerchiamo di arrivare all'essenza delle cose eliminando il superfluo e tenendo sempre al centro l'essere umano. Non ci piacciono gli oggetti 'sculturali', da ammirare a distanza, vogliamo che i nostri oggetti trasmettano la voglia di essere toccati. La funzionalità è un requisito di base che diamo per scontato e sul quale cerchiamo di suggerire una storia, fatta di memorie o di sensazioni, che crei quel legame impalpabile tra oggetti e persone." Negli ultimi anni hanno consolidato la loro attività professionale disegnando per grandi aziende internazionali, alla quale affiancano attività didattica tenendo corsi di design alla scuola EINA di Barcellona. Il loro lavoro è stato premiato con i premi Delta de plata 2012 e la Selección Delta 2014.

CrousCalogero is a product design consultancy founded in 2009 by Francesco Crous and Alessandro Calogero after a decennial experience side by side with famous designers and inside big companies' design departments. They explain their method as follows: "Our way of working is simple: we try to get to the essence of things, eliminating what is superfluous, always with a focus on the human being. We don't like 'sculptural' objects, to admire from a distance. We want our objects to transmit a desire to be touched. Functional quality is a basic requirement we take for granted. On top of it we try to suggest a story, made of memories or sensations, to create that impalpable link between objects and people." In recent years they strengthen their collaboration with different international design firms. Alongside their professional activity they also teach at the design school EINA in Barcelona. CrousCalogero's work has been awarded with prestigious prizes like the Silver Delta 2012 and the Delta Selection 2014.

[
DE
SI
GN
ERS
]

/ : TRANSVERSAL INNOVATION

DARE UN SIGNIFICATO ALLE COSE ED AGLI EVENTI È UN APPROCCIO NATURALE NELL'UOMO: TUTTI NOI COMPRIAMO DEI PRODOTTI O DEI SERVIZI PERCHÈ HANNO UN SIGNIFICATO NELLA NOSTRA VITA O NEL NOSTRO LAVORO. CON IL TEMPO QUESTI SIGNIFICATI SI CRISTALLIZZANO E DIVENTANO DEI PARADIGMI CHE TUTTI CONDIVIDONO. AD ESEMPIO LA CUCINA È IL POSTO DOVE SI PREPARANO E SI CONSUMANO I PASTI, QUINDI DEVE SODDISFARE BISOGNI QUALI LA CONSERVAZIONE E LA PREPARAZIONE DEL CIBO E LA POSSIBILITÀ DI SEDERSI PER MANGIARE. LA CUCINA PERÒ HA ANCHE ALTRI SIGNIFICATI: È IL LUOGO DOVE LA FAMIGLIA SI INCONTRA, DOVE OGNUNO DI NOI SI RISTORA PRIMA DI INIZIARE LA SUA GIORNATA... E' POSSIBILE IDENTIFICARE ANCHE ALTRI SIGNIFICATI, MENO OVVI, MAGARI NON APPLICABILI A TUTTI COLORO CHE ACQUISTANO UNA CUCINA, MA COMUNQUE IMPORTANTI PER ALCUNI GRUPPI DI UTILIZZATORI. NUOVI SIGNIFICATI GENERANO NUOVI PARADIGMI DI UTILIZZO E QUINDI NUOVI PRODOTTI, DIVERSI DAI PRECEDENTI. IDENTIFICARE I TREND CULTURALI E SOCIALI CHE STANNO MODIFICANDO I SIGNIFICATI E CHIEDERSI COME INTEGRARE QUESTI NUOVI SIGNIFICATI NEI PRODOTTI È L'INTERROGATIVO COSTANTE CHE SI PONE IL BRAND TWENTYFIRST. REINTERPRETARE IL CONTESTO DI UTILIZZO DEL NOSTRO PRODOTTO UTILIZZANDO PARADIGMI DIVERSI DA QUELLI FINORA UTILIZZATI. UN VASO, UN APPENDIABITI, UNA SEDUTA, POSSONO DIVENTARE ALTRO DA QUELLO CHE SONO; SI POSSONO UTILIZZARE COME LAMPADINE, PORTAOGGETTI, UNA SEDUTA SE SISTEMATA VERTICALMENTE PUÒ DIVENTARE UNA LIBRERIA. TWENTYFIRST RICERCA L'INNOVAZIONE TRASVERSALE. IDENTIFICATO UN NUOVO SIGNIFICATO E DUNQUE UNA NUOVA FUNZIONE, È POSSIBILE RIDISEGNARVI INTORNO LA USER EXPERIENCE IN TERMINI SIA FUNZIONALI, CHE EMOZIONALI. L'INNOVAZIONE DEI PRODOTTI E DEI SERVIZI SI PUÒ RAPPRESENTARE COME "LINEARE" O "TRASVERSALE". L'INNOVAZIONE LINEARE CONSISTE NEL MIGLIORAMENTO INCREMENTALE DELLE CARATTERISTICHE DEL PRODOTTO O DEL SERVIZIO. L'INNOVAZIONE TRASVERSALE È INVECE UN CAMBIAMENTO SOSTANZIALE DEL PARADIGMA DI UTILIZZO DEL PRODOTTO. OGNI PROGETTO PENSATO PER LA COLLEZIONE TWENTYFIRST DEVE AVERE UNA FUNZIONALITÀ, OVVERO DEVE ESSERE PROGETTATO PER ESSERE UTILE E SODDISFARE UN BISOGNO, UN'ESIGENZA. LA NOSTRA SFIDA È QUELLA DI CREARE UNA NUOVA FUNZIONALITÀ. SIA ESSA "NUOVA" OVVERO UN OGGETTO PROGETTATO PER SODDISFARE UN'ESIGENZA CHE PRIMA NON ERA SODDISFATTA; "NOTA", OVVERO GIÀ INCORPORATA IN ALTRI OGGETTI ESISTENTI SUL MERCATO; "REINTERPRETATA", VOLTA CIOÈ A SODDISFARE UN'ESIGENZA NOTA E GIÀ ASSOLTA, MA CON UN OGGETTO CHE RICHIAMA NELLA FORMA E NEL DESIGN ALTRI CONCETTI INSOLITI. UNA NUOVA FUNZIONALITÀ SI PUÒ RITROVARE ANCHE NEL "REVIVAL", OVVERO RICHIAMARE UN CONCETTO DEL PASSATO O DELLA PROPRIA INFANZIA E FARLO RIVIVERE CON UNO STILE NUOVO.

GIVING SIGNIFICANCE TO THINGS AND EVENTS IS MAN'S NATURAL APPROACH. ALL OF US BUY PRODUCTS OR SERVICES BECAUSE THEY HAVE MEANING IN OUR LIVES OR OUR WORK. WITH TIME, THESE MEANINGS BECOME MORE CRYSTALLINE, AND THEY ARE A TRUE PARADIGM THAT WE ALL SHARE. FOR EXAMPLE, THE KITCHEN IS A PLACE WHERE WE PREPARE AND EAT OUR MEALS, AND IT MUST THEREFORE SATISFY NEEDS SUCH AS PRESERVATION AND PREPARATION OF FOOD AS WELL AS A PLACE TO SIT AND EAT OUR FOOD. THE KITCHEN ALSO HAS OTHER MEANINGS: IT IS THE PLACE WHERE A FAMILY WILL MEET, WHERE WE ALL REPLENISH OUR BODIES BEFORE STARTING OUR DAYS. WE CAN ALSO IDENTIFY OTHER MEANINGS, LESS OBVIOUS, AND MAYBE NOT APPLICABLE TO EVERYONE WHO BUYS KITCHEN FURNITURE, BUT STILL QUITE IMPORTANT TO CERTAIN CONSUMER GROUPS. THERE ARE NEW MEANINGS THAT GENERATE NEW SHIFTS IN PARADIGMS, AND THEREFORE NEW PRODUCTS THAT ARE DIFFERENT FROM PREVIOUS ONES. IDENTIFYING CULTURAL AND SOCIAL TRENDS THAT ARE MODIFYING MEANINGS, AND ASKING OURSELVES HOW TO USE THESE NEW MEANINGS IN PRODUCTS, IS A CONSTANT FOR THE TWENTYFIRST BRAND. WE REINTERPRET THE CONTEXT OF USE OF OUR PRODUCTS, USING NEW PARADIGMS THAT ARE DIFFERENT FROM THOSE THAT HAVE BEEN USED UP TO NOW. A VASE, A CLOTHES HANGER, A SEAT ... THEY CAN ALL BECOME MUCH MORE THAN WHAT THEY ARE. THEY CAN BE USED AS LAMPS OR CONTAINERS, AND A SEAT CAN BE USED AS A LIBRARY WHEN TURNED VERTICALLY. TWENTYFIRST IS ALWAYS SEARCHING FOR TRANSVERSAL INNOVATION. WHEN IDENTIFYING A NEW MEANING, AND THEREFORE A NEW FUNCTION, IT IS POSSIBLE TO REDESIGN AROUND THE USER EXPERIENCE IN TERMS OF FUNCTION AND EMOTION. PRODUCT AND SERVICES INNOVATION CAN BE REPRESENTED AS "LINEAR" OR "TRANSVERSAL". LINEAR INNOVATION CONSISTS IN INCREMENTAL IMPROVEMENT OF PRODUCT OR SERVICE CHARACTERISTICS. TRANSVERSAL INNOVATION IS A SUBSTANTIAL CHANGE IN THE PARADIGM OF USE OF THE PRODUCT. ALL TWENTYFIRST PROJECTS MUST HAVE A FUNCTIONALITY. THEY MUST BE DESIGNED TO BE USEFUL AND SATISFY A NEED OR REQUIREMENT. OUR CHALLENGE IS TO CREATE A NEW FUNCTION. BE IT "NEW", OR AN OBJECT THAT IS DESIGNED TO SATISFY A NEED THAT HAS NEVER BEFORE BEEN MET, OR "NOTED", WHICH IS A NEED THAT HAS BEEN ADDRESSED BY OTHER OBJECTS THAT ARE AVAILABLE ON THE MARKET. A FUNCTION CAN ALSO BE "REINTERPRETED", AND THEREFORE AIMING TO SATISFY A NEED THAT HAS ALREADY BEEN SATISFIED BUT WITH AN OBJECT THAT RECALLS, IN ITS SHAPE AND DESIGN, OTHER UNUSUAL CONCEPTS. A NEW FUNCTION CAN BE FOUND IN "REVIVAL", OR RECALLING A CONCEPT FROM THE PAST OR FROM OUR CHILDHOOD AND MAKE IT COME TO LIFE WITH A NEW STYLE.

**CHAIRS & TABLES****7****TECHNICAL SHEETS****168**

ANGELICA & ORLANDO

9

172

GROOVE COLLECTION

23

168 /169

TOM & DAISY

35

170

DODÒ & NANÀ

47

171

PACIFICO & BEATO

53

174

SERENO

63

175

HHC

71

173

JOHN

83

173

SWAP

93

175

DESIGN 'A' BILLY

103

176

(JOE STOOL & BOB TABLE)

FURNISHINGS**105****177**

WINTERTREE

107

177

META

117

177

DANGO

129

178

AMEBA

141

178

JACK

149

179

TECHNICAL SHEETS**157****157**POLIETILENE: CARATTERISTICHE
POLYETHYLENE: FEATURES

159

159

DRESSED COLLECTION COLOURS

160

160

NUDE COLLECTION COLOURS

161

161

LIGHTING COLLECTION COLOURS

162

162

LIGHTING KIT INDOOR / OUTDOOR

163

163

GROOVE ACCESSORIES:
OUTDOOR CUSHIONS

164

164

OPTIONALS AMEBA

166

166

KIT PIASTRA DI ANCORAGGIO
ANCHOR PLATE KIT

167

167

INDEX

CHAIRS & TABLES	7
ANGELICA & ORLANDO	9
GROOVE COLLECTION	23
TOM & DAISY	35
DODÒ & NANÀ	47
PACIFICO & BEATO	53
SERENO	63
HHC	71
JOHN	83
SWAP	93
DESIGN 'A 'BILLY (JOE STOOL & BOB TABLE)	103

TECHNICAL SHEETS

168

172

168 /169

170

171

174

175

173

173

175

176

CHAIRS & TABLES

SEMPLICITÀ, ORIGINALITÀ, STUPORE. L'USO DEI COLORI E L'ATTENZIONE PER LE CARATTERISTICHE DISTINTIVE SONO CONCETTI FONDAMENTALI PER TWENTYFIRST. PARTICOLARMENTE INDICATI PER LE INSTALLAZIONI CONTRACT, LE SEDUTE E I TAVOLINI TWENTYFIRST SONO PRATICI ED ERGONOMICI, PENSATI PER GLI AMANTI DELLA VITA ALL'ARIA APERTA.

SIMPLICITY, ORIGINALITY, AMAZEMENT. THE USE OF COLORS AND THE FOCUS ON EFFECTIVE FEATURES ARE THE FOUNDATIONS FOR TWENTYFIRST. PARTICULARLY SUITABLE FOR CONTRACT INSTALLATIONS, ALL TWENTYFIRST CHAIRS AND TABLES ARE PRACTICAL AND ERGONOMIC, MEANT FOR OUTDOORSY SPIRITS.

Angelica & Orlando,
Groove Collection,
Tom & Daisy, Dodò & Nanà,
Pacifico & Beato, Sereno,
HHC, John, Swap,
Design 'a 'Billy
(Joe stool & Bob Table)



ORLANDO & ANGELICA

polietilene riciclabile | recyclable polyethylene

ORLANDO Coffee Table **COD. BOBF047**

ANGELICA Chair **COD. BOBF025**

INDOOR / OUTDOOR / RESIDENTIAL / CONTRACT

ARMONIA E COMFORT

L'ispirazione arriva dal poema cavalleresco "L'Orlando innamorato", un'opera rimasta incompiuta che lascia spazio a interpretazioni personalizzate: un cavaliere ed una principessa, protagonisti indiscussi delle favole incantate, due nomi Italiani che raccontano tradizione, arte e storia di un popolo dalle forti radici culturali.

ORLANDO e ANGELICA, un tavolino funzionale ed una sedia sinuosa, rappresentano una collezione caratterizzata da grandi superfici che si espandono in modo uniforme messe in contrasto con linee precise e tese, generando un gioco naturale di luce ed ombra. Un tratto estetico distintivo che permette di cogliere sempre nuovi dettagli guardando ANGELICA e ORLANDO da ogni punto di vista. Il tavolino ORLANDO è dotato di una vasca centrale con foro di drenaggio, ideale per contenere delle bottiglie con ghiaccio nelle giornate calde e afose. Silhouette decisa ma nello stesso tempo confortevole, funzionale, armoniosa.

HARMONY AND COMFORT

The inspiration comes from the Italian chivalrous poem "The Orlando in love" - "L'Orlando innamorato" -, a work left unfinished that allows for personalized interpretations: a knight and a princess, protagonists of enchanted fairy tales, two names that tell Italian tradition, art and history of people with strong cultural roots. ORLANDO and ANGELICA, a functional small table and a sinuous chair, represent a collection characterized by large areas that expand evenly placed in contrast with precise and stretched lines, creating a natural game of light and shadow. A distinctive aesthetic line that allows us to see always new details looking at ANGELICA and ORLANDO from any point of view.

The table ORLANDO has a central basin with drain hole, ideal for storing bottles with ice on hot and muggy days. A resolute Silhouette which is at the same time comfortable, functional, harmonious.



ANGELICA CHAIR

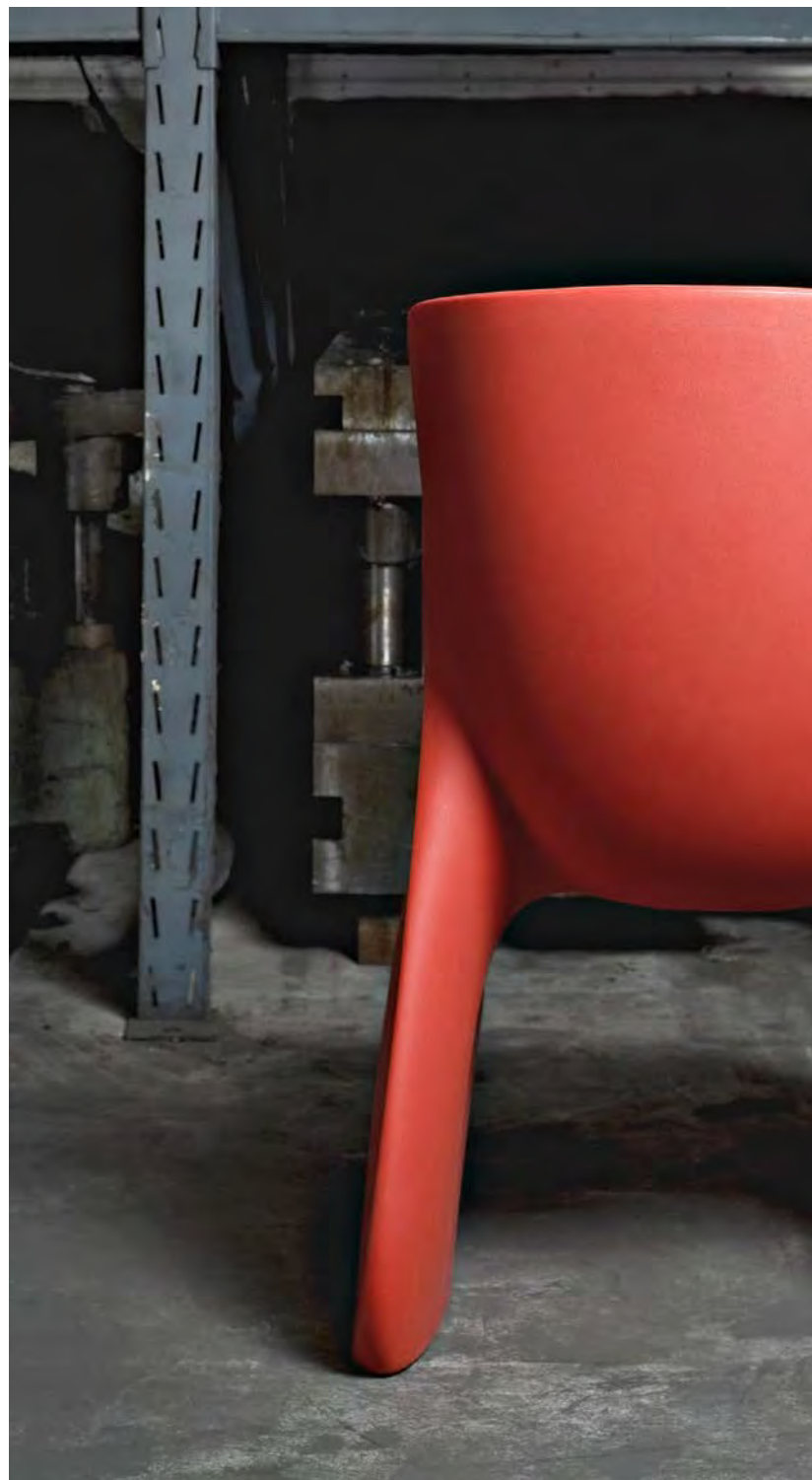







A RESOLUTE
SILHOUETTE WHICH
IS AT THE SAME TIME
COMFORTABLE,
FUNCTIONAL,
HARMONIOUS







ORLANDO COFFEE TABLE





HARMONY AND COMFORT







GROOVE

polietilene riciclabile | recyclable polyethylene

Coffee Table **COD. BOBE050** | Armchair **COD. BOBE047** | Sofa **COD. BOBE095**
INDOOR / OUTDOOR / RESIDENTIAL / CONTRACT

GROOVE è una collezione dal design raffinato ed estremamente minimalista, caratterizzata da strisce longitudinali, in grado di creare un feeling con l'utente attraverso un linguaggio ritmico, quasi musicale, ed un'ergonomia progettati per il massimo relax. Ideale per decorare gazebo, portici, spiagge, terrazze all'aperto, GROOVE è in grado di personalizzare con carattere ed eleganza anche spazi interni come reception, club, discoteche, sale e ingressi. Grazie al suo stile fresco, scenico ed elegante, GROOVE è una vera collezione multiuso. Oggi il mercato offre proposte di arredamento innumerevoli. Si va dal vintage al minimalista, dal retro fino a tendenze stilizzate e colorate dedicate ai più piccoli. Twentyfirst propone GROOVE: una collezione che aggiunge una nuova dimensione al brand e allo stesso tempo riesce a distinguersi tra la vasta gamma di mercato.

GROOVE is a collection with a refined and extremely minimalist design, characterized by longitudinal strips, able to create feeling with the user through a rhythmic almost musical language and ergonomics designed for ultimate relaxation. Ideal for decorating gazebos, arcades, beaches, winter and summer terraces, able to customize with character and elegance even indoor spaces such as reception, clubs, discos, halls and entrances. Thanks to its fresh, scenic and elegant style, GROOVE is a true multipurpose collection. The market offers innumerable furnishing proposals. They range from vintage to minimalist from retro to stylized and colourful designs devoted to children. For its part, Twentyfirst proposes GROOVE: a collection that adds a new dimension to the brand and at the same time manages to stand out from the wide range on the market.



CUSCINI CUSHIONS

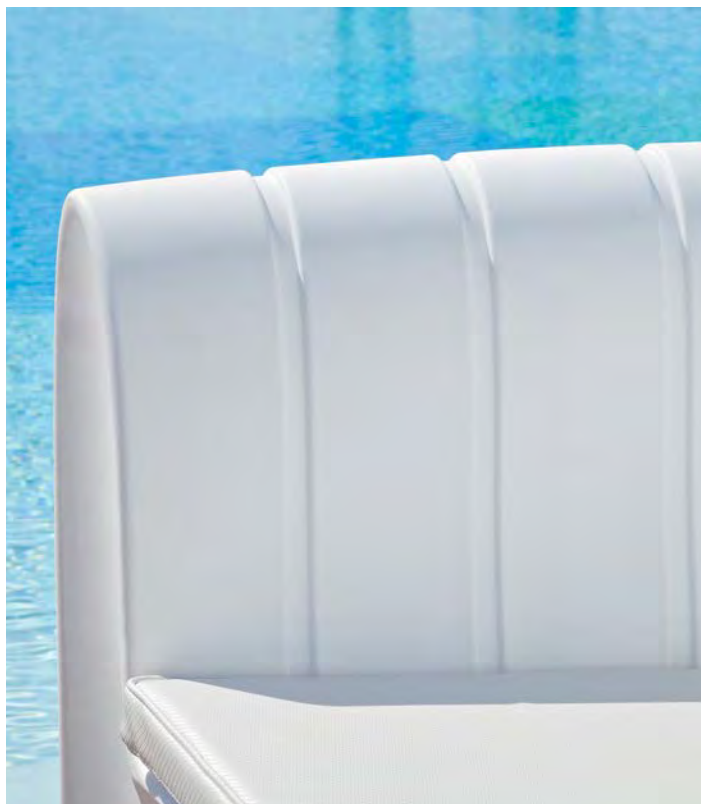

CUSCINO SINGOLO PER POLTRONA // CUSCINO DOPPIO PER SOFA
SINGLE CUSHION FOR ARMCHAIR // DOUBLE CUSHION FOR SOFA







ARMCHAIR,
SOFA
& COFFEE TABLE



GR
OO
VE

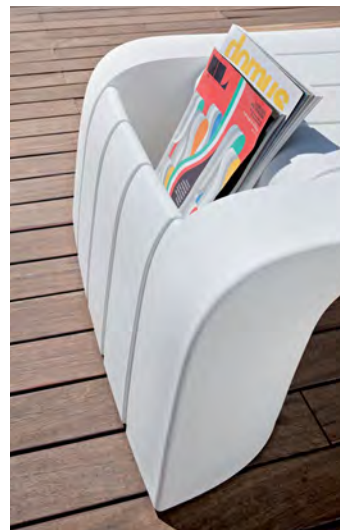





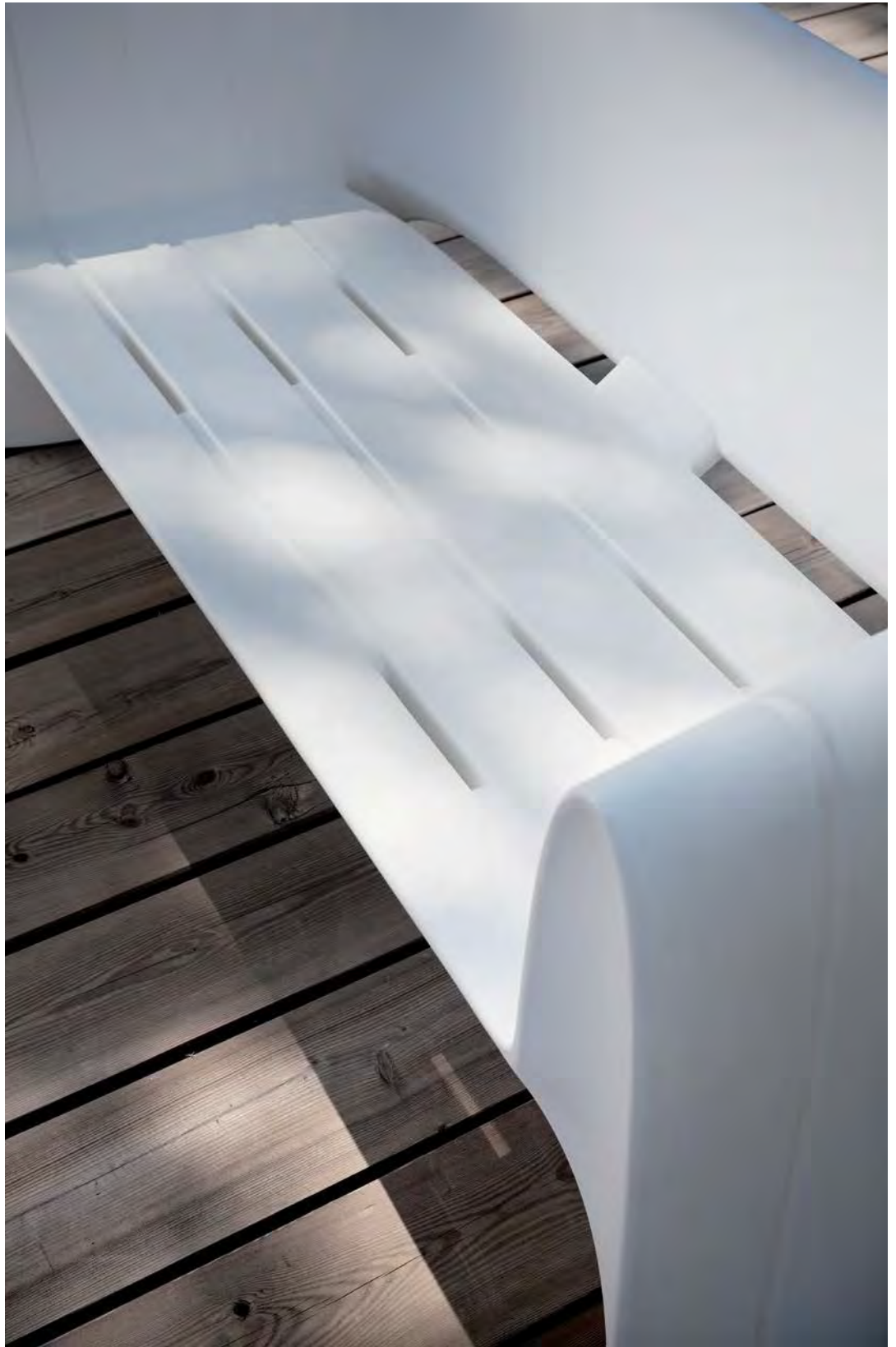



TOM & DAISY

polietilene riciclabile | recyclable polyethylene

TOM Coffee Table **COD. BOBH023**

DAISY Armchair **COD. BOBH037**

INDOOR / OUTDOOR / RESIDENTIAL / CONTRACT

La collezione avviata con lo sgabello Dodò ed il tavolino alto Nanà si arricchisce di due nuovi elementi eleganti e originali: TOM & DAISY. Essi rappresentano la nuova coppia creata dalle menti di Studio Thesia Progetti e prodotta da 21st. Ispirati dal capolavoro letterario di F.S. Fitzgerald, "Il grande Gatsby", TOM e DAISY sono i solidi protagonisti di una storia d'amore sopraffatta dall'avidità e l'opportunismo. Una coppia che non esiste mai come tale. E come gli innamorati del romanzo, anche i nostri TOM e DAISY hanno ciascuno un'identità propria che li rende indipendenti e allo stesso tempo complementari. DAISY è una comoda e spaziosa poltroncina in polietilene colorato, molto raffinata ed accogliente nella sua semplicità. Al suo fianco il fedele TOM, un tavolino basso in cui prosegue lo studio della linea curva utilizzata con maestria per creare pezzi di design sinuosi e funzionali. TOM e DAISY sono adatti sia ad ambienti indoor che a spazi outdoor. Sono apprezzati da chi vuole arredare con stile e raffinatezza senza rinunciare ad un tocco di originalità. TOM e DAISY sono estremamente versatili, si inseriscono perfettamente in svariate cornici: terrazze estive, lounge bar, giardini, abitazioni private. L'ampia disponibilità di colori li rende ulteriormente personalizzabili e in sintonia con l'ambiente che li circonda.

The collection born with Dodò stool and Nanà high-table extends with two new elegant and original elements: TOM & DAISY. Together they represent the new couple designed by the minds of Studio Thesia Progetti and produced by Twentyfirst. Inspired by the F.S. Fitzgerald's literary masterpiece, "The Great Gatsby", TOM and DAISY are the firm protagonists of a love story overwhelmed by greed and opportunism. A couple that never exists as such. And as the lovers of the novel, even our TOM and DAISY have their own personal identity that makes them independent and complementary at the same time. DAISY is a comfortable and spacious armchair made of coloured polyethylene, sophisticated and comfortable in its simplicity. At its side the faithful TOM, a low coffee table where the study of the curved lines is used with mastery to create sinuous and functional pieces of design.

TOM and DAISY are suitable for both indoor and outdoor spaces. They are prized by those who want to decorate with style and sophistication the living spaces without losing a touch of originality. TOM and DAISY are very versatile, they fit perfectly in a variety of frames: summer terraces, a lounge bar, gardens and private homes. The wide range of colours makes them further customizing and in harmony with the surrounding background.



DAISY ARMCHAIR











TOM
CO
FF
EE
TA
BLE









TOM AND DAISY ARE
VERY **VERSATILE**:
THEY FIT PERFECTLY IN
SUMMER TERRACES,
LOUNGE BARS,
GARDENS AND PRIVATE
HOMES





DODÒ E NANÀ

polietilene riciclabile | recyclable polyethylene

DODÒ Stool **COD. BOB8040**

NANÀ High Table **COD. BOB9055**

INDOOR / OUTDOOR / RESIDENTIAL / CONTRACT

La bellezza e l'eleganza della curva è usata con semplicità e maestria per creare pezzi dal design funzionale ma nel contempo originali e capaci di rompere gli schemi: lo sgabello DODÒ ed il tavolino NANÀ. Due pezzi distinti, ma disegnati per stare insieme. La linea, piacevole ed essenziale, nasce dal mondo dell'organico come richiamo alla natura ma allo stesso tempo proiettata nel futuro. La curva e la morbidezza dei raccordi definiscono l'eleganza e la perfetta adattabilità ad ogni ambiente: locali e lounge bar, abitazioni private, adatte a chi ama arredare in modo raffinato con un tocco di originalità. Le particolari cromie ne esaltano le virtù formali e rendono DODÒ e NANÀ protagonisti dello spazio che li circonda.

The beauty and elegance of curves was used with mastery and simplicity to create pieces that have a functional design, yet they are at the same time quite original and able to break the rules. They are the DODÒ stool and the NANÀ table. Two different pieces but designed to go together. The pleasant and basic lines, developed by a team of creatives at Thesia Progetti, are a call to nature and to the organic world. At the same time they propel us into the future. It's a formal choice but it is able to be innovative and go beyond obsolete systems. The curves and softness of the connections bring elegance and perfect adaptability to every space, be it a lounge bar, club, or even an unusual private residence. They are ideal for those who wish to furnish spaces with sophistication and a touch of originality. The characteristic set of colors enhance the formal features and make them the true protagonists of the space that surrounds them.



STOOLBAR & HIGH TABLE



THEY ARE THE TRUE
PROTAGONISTS
OF THE SPACE
THAT SURROUNDS
THEM



DO
DO





PACIFICO & BEATO

polietilene riciclabile | recyclable polyethylene

PACIFICO Coffee Table **COD. BOBA528**

BEATO Pouf **COD. BOBA023**

INDOOR / OUTDOOR / RESIDENTIAL / CONTRACT / LIGHT OPTIONAL

PRATICI, FUNZIONALI, DECORATIVI, SCENICI.

Queste linee dalla forte valenza evocativa sono ottenute con l'ausilio di tecnologie avanzate e gusto per il dettaglio di matrice artigianale. BEATO e PACIFICO soddisfano a pieno l'uso per cui sono stati progettati, racchiudendo in sé una forte valenza simbolica che si stempera nel loro aspetto ironico e "pacifico". BEATO diventa parte dei nostri momenti di relax, integrandosi nell'ambiente circostante quasi come un pezzo di storia. PACIFICO ci vuole trasmettere la sua memoria, seduti attorno ad esso possiamo godere della sua particolare bellezza ed apprezzarlo per il suo semplice ed immediato uso. SERENO, PACIFICO e BEATO sono realizzati in polietilene rotazionale. Ideali per giardini, spazi pubblici, spazi aperti ed ambienti Contract, si prestano anche per installazioni indoor. Sono tutti disponibili anche in versione illuminata.

PRACTICAL, FUNCTIONAL, DECORATIVE, SCENIC.

These evocative shapes are obtained by the use of advanced technologies and a taste for artisan detailing. BEATO POUF and PACIFICO TABLE fully satisfy the use they were designed for. They have a strong symbolic value that actually dilutes their seemingly ironic and "peaceful" appearance. BEATO becomes part of our relaxing moments, integrating itself in the surrounding space almost like a piece of history. PACIFICO wants to give us its memory, as we sit around this coffee table we can take in its beauty and appreciate it for its simplicity and immediacy. SERENO, PACIFICO and BEATO are made of rotational polyethylene. Perfect for garden, public spaces, open spaces and Contract locations, they suit also for indoor installations. They are all available also with light.



















Design: Moredesign
Poltrona - Totem | Armchair - Totem

SERENO

polietilene riciclabile | recyclable polyethylene

Totem / Armchair **COD. BOBB585**

INDOOR / OUTDOOR / RESIDENTIAL / CONTRACT / LIGHT OPTIONAL

Moredesign ha ideato per Twentyfirst SERENO, una scultura dalle forti linee suggestive, un'originale seduta di grande formato che completa la ricerca iniziata con BEATO e PACIFICO. Riprende le forme antropomorfe del pouf e del tavolo, fornendo però una seduta ampia e confortevole. Perfetto per un cocktail all'aperto, diviene il luogo ideale per conversare e godere a pieno della magica atmosfera notturna. SERENO può essere pensato anche come "opera d'arte" che ridisegna e reinterpreta il paesaggio circostante. Un messaggio di quiete, meditazione e protezione tramite l'espressione di una figura realizzata con materiali e tecnologie innovative ma con lo spirito di tempi antichi e misteriosi.

SERENO è disponibile in versione illuminata. E' perfetto per ambienti Contract, giardini, spazi pubblici, spazi aperti e si presta ottimamente anche per installazioni indoor.

Moredesign has designed for Twentyfirst SERENO, an important sculpture with strong and evocative lines, an original large format chair that completes the line of thinking that created BEATO and PACIFICO. SERENO has the same anthropomorphic lines of the pouf and the table but with a spacious and comfortable seat. It is perfect for a cocktail outdoors, and becomes the ideal conversation spot, where you can enjoy the magical night-time ambiance. SERENO is "artwork" that is utilized to rethink and reinvent the surrounding landscaping. A message of peace, meditation and protection comes with it; its lines are designed with innovative materials and technologies but with the spirit of ancient and mysterious times.

SERENO is available also with light. It's perfect for Contract locations, garden, public spaces, open spaces and it suits for indoor installations excellently.















HAPPY HOUR CROSS

polietilene riciclabile | recyclable polyethylene

Lounge System **COD. BOBBO20**

INDOOR / OUTDOOR / RESIDENTIAL / CONTRACT / LIGHT OPTIONAL

Sistema modulare pensato ad hoc per essere utilizzato in tutte quelle situazioni che richiedono la presenza di pratiche e funzionali postazioni lounge: ideali per sorseggiare un drink in compagnia.

Adatte alle più svariate location utilizzate per eventi mondani, perfette per gli ambienti, interni o esterni, di locali ricercati. La HAPPY HOUR CROSS è la risultante dell'accostamento di quattro moduli uguali (realizzati in polietilene rotazionale) ognuno dei quali integra due sedute ed un piano d'appoggio. Il modulo base può essere utilizzato anche singolarmente (per soluzioni ad angolo) o accoppiato (per soluzioni a parete). Quello che stupisce della HAPPY HOUR CROSS è che, benché nata da un rigoroso approccio formale e funzionale al prodotto, sia in grado, immediatamente, di connotare con originalità lo spazio in cui va ad inserirsi, "affermandosi" come una soluzione innovativa per le zone lounge in cui convivialità ed utilizzo si armonizzano tra loro, riuscendo, con il suo design pulito ma distintivo, ad esaltare aspetti fondamentali della filosofia Twentyfirst quali la funzionalità (reinterpretata) e la modularità.

HAPPY HOUR CROSS is a modular system that seems like it is made-to-measure, so that it can be moulded to all those situations that require the presence of practical and functional lounge stations. Wonderful when enjoying a drink and a conversation. It is suitable for a variety of locations that are utilized for social events, perfect for living areas, both interior and exterior, and for sophisticated situations as well. HAPPY HOUR CROSS is the result of mixing together four modules (made of rotational polyethylene), with each module having two seats and a table. The base module can be used by itself (for corners) or in couple with another module (for walls). What is surprising about HAPPY HOUR CROSS is that even if it was created with a formal and functional product design approach, it is immediately able to connote the space it occupies with originality, and affirms itself as an innovative solution for lounge areas, where conviviality and use harmonize together. With its clean but distinctive lines it is able to enhance the basic aspects of the Twentyfirst philosophy, such as function (reinterpreted) and modularity.



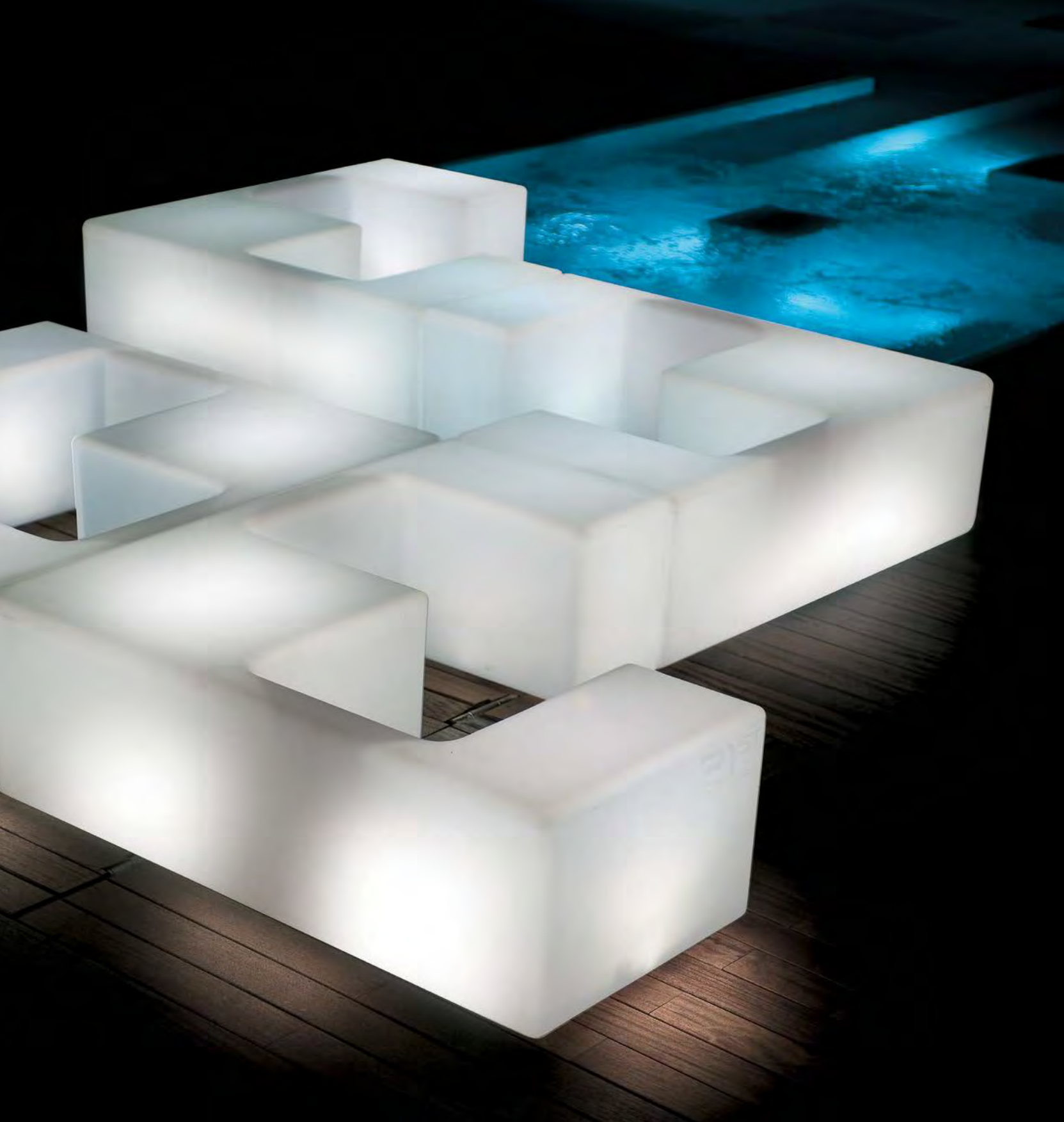

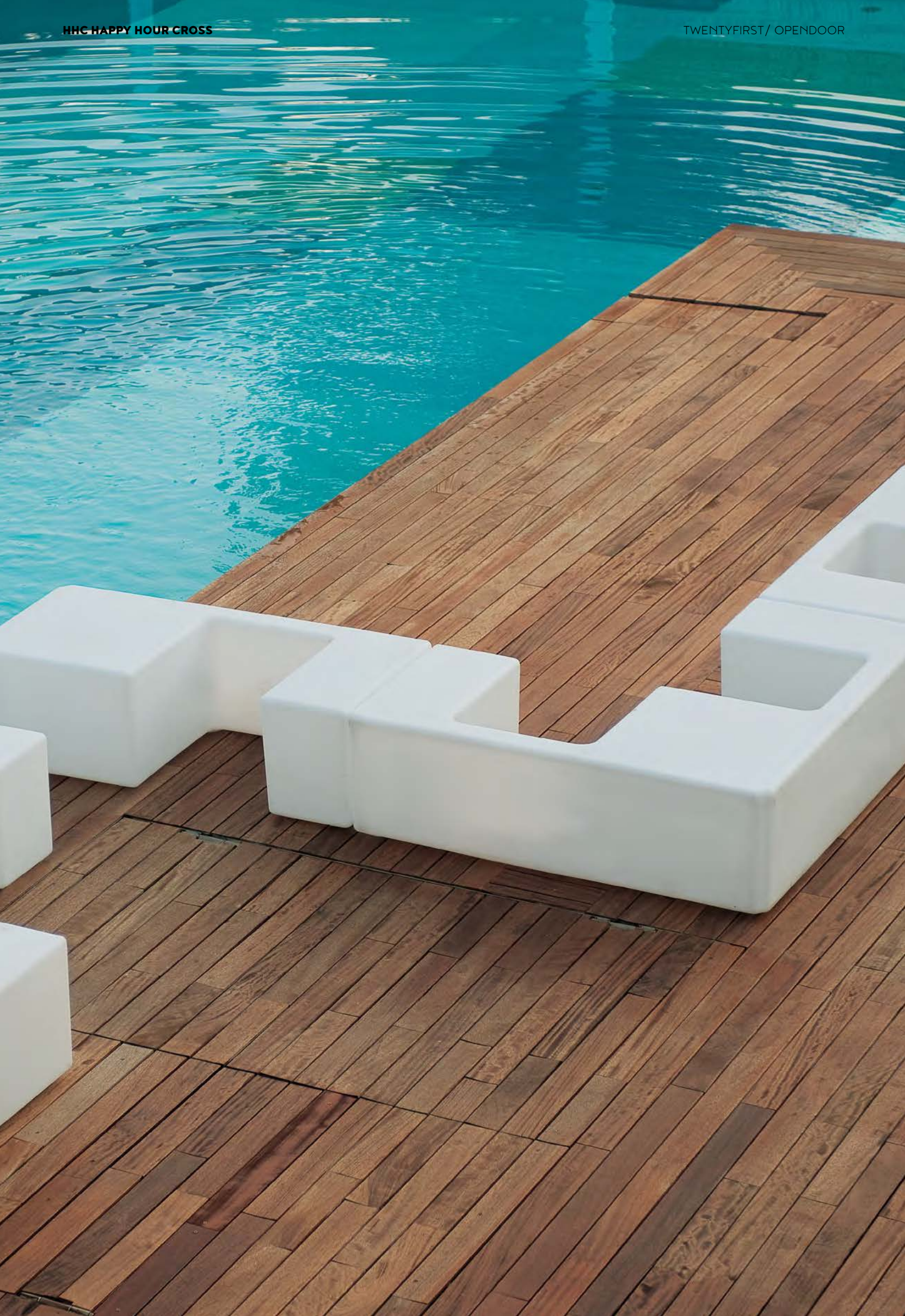

HAPPY HOUR CROSS
IS THE EPITOME
OF ONE OF THE
FUNDAMENTAL
ASPECTS OF
TWENTYFIRST'S
UNDERLYING
PHILOSOPHY:
MODULARITY



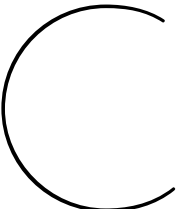
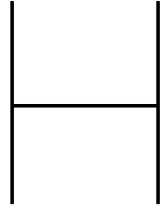
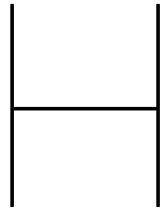



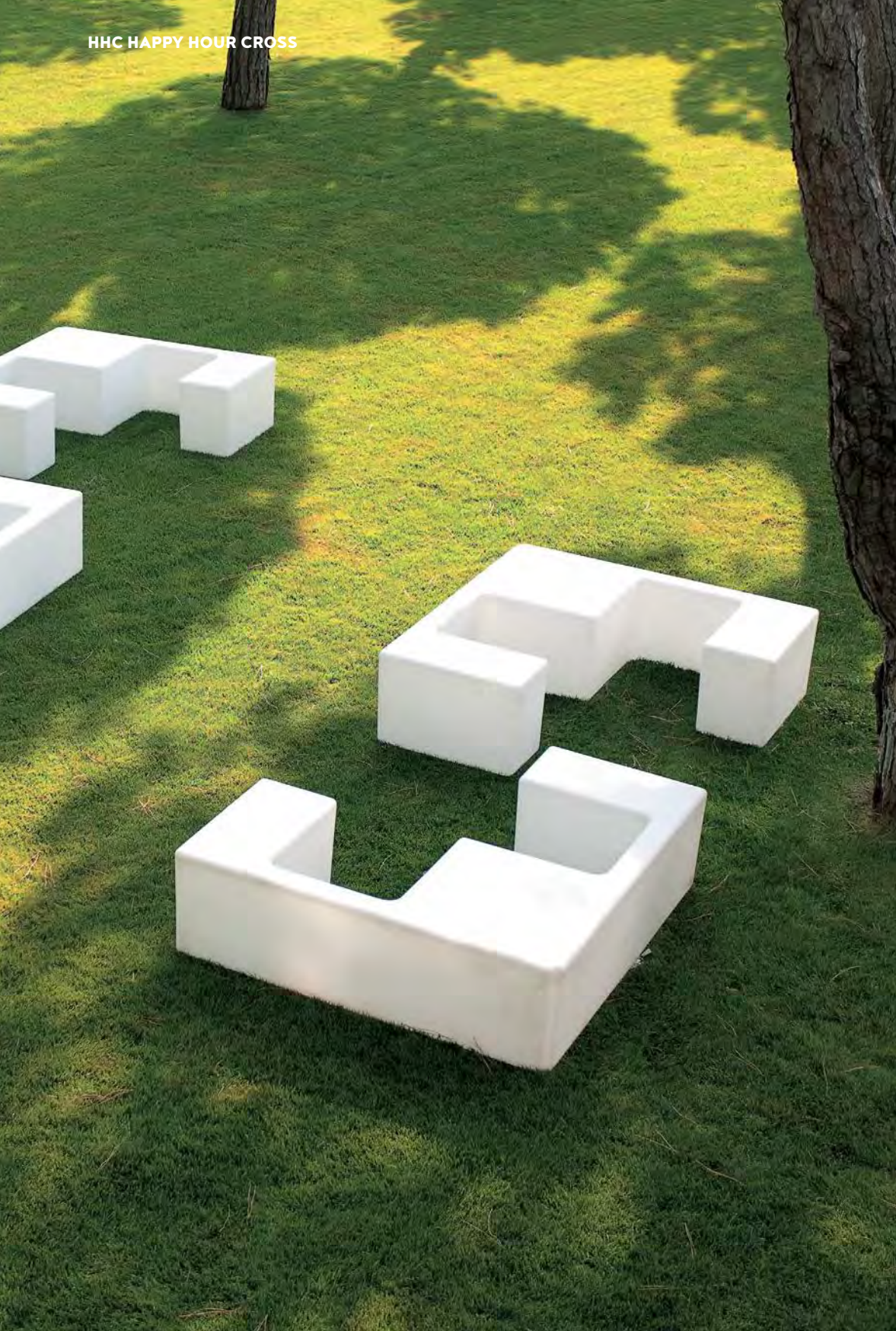





ECLECTIC & VERSATILE





Design: Mario Mazzer
Sedia impilabile | Stackable chair

JOHN

polietilene riciclabile | recyclable polyethylene
Stackable chair **COD. BOBC040**

INDOOR / OUTDOOR / RESIDENTIAL / CONTRACT

UNA SEDIA CON UN'ANIMA GIOVANE.

Mario Mazzer crea per Twentyfirst una sedia reinventandone la funzionalità. In quanti modi si può usare una sedia? Ci si può sedere, appoggiare, sostenere, dondolare, ma una volta fatte queste azioni ci possiamo riporre qualcosa? JOHN, grazie ad un piccolo ripiano posto sullo schienale, soddisfa a pieno la necessità di posare un cocktail, riporre un libro o ciò che in quel momento si ha tra le mani. Diviene un comodo tavolino per un aperitivo all'aperto, un leggio, una pratica work station per un tablet.

A CHAIR WITH A YOUNG SOUL.

Mario Mazzer has created a chair with a new functionality for Twentyfirst. In how many ways you can use a chair? You can sit, lean, support and swing. But where do you put your drink? JOHN has a small shelf on the seat back that lets you place your cocktail, your book, or anything else you may have in your hands. It becomes a convenient table for an outdoor aperitif, a lectern, or a practical work station for a laptop or tablet.







CH

AIR

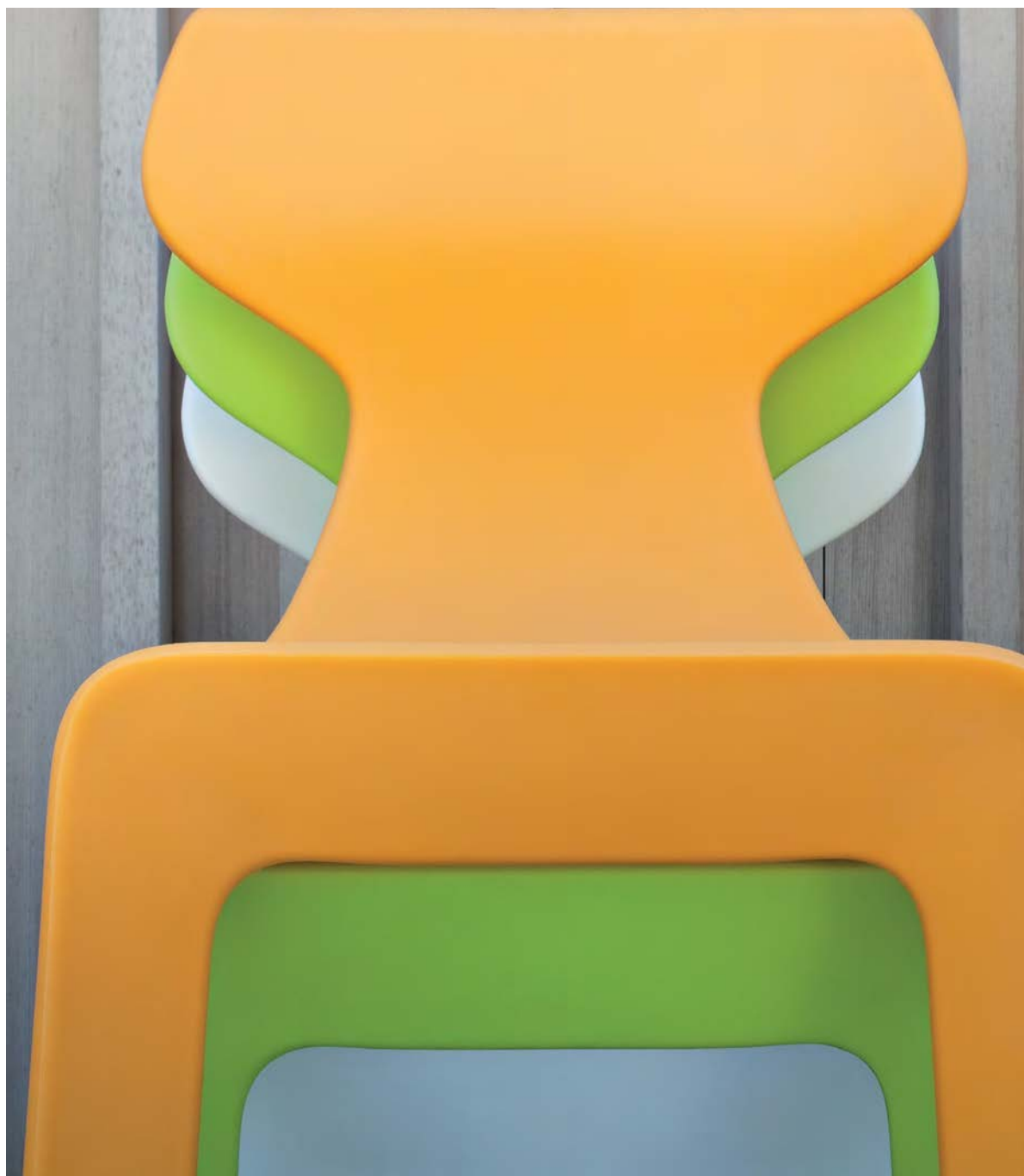







A CHAIR WITH A YOUNG SOUL





Design: CrousCalogero
Lampada - Tavolino | Lamp - Small table

SWAP

polietilene riciclabile | recyclable polyethylene

Lamp - Small table **COD. BOC2025**

INDOOR / OUTDOOR / RESIDENTIAL / CONTRACT

SWAP è una lampada che funziona perfettamente da sola, progettata per creare atmosfere sceniche con eleganza e sobrietà. SWAP è anche un pratico tavolino alto, accanto ad un paio di sgabelli diventa un comodo appoggio per gustare un drink durante una festa, ideale per servizi di catering.

SWAP is a lamp that perfectly works on its own, designed to create scenic atmospheres with elegance and sobriety. SWAP is also a practical high table, next to a couple of stools it becomes a comfortable standing support for a drink at a party, perfect for catering services.



UPSIDE DOWN LAMP









SW
AP









Design: Graziano Moro e Renato Pigatti
Sgabello e Tavolino | Stoolbar & High table

DESIGN'A'BILLY COLLECTION

polietilene riciclabile | recyclable polyethylene

JOE Stool **COD. BOBG037**

BOB High Table **COD. BOBG055**

INDOOR / OUTDOOR / RESIDENTIAL / CONTRACT

Un approccio diverso dal solito design, dove si va oltre l'oggetto stesso, vedendo in esso delle storie da raccontare. Dalla volontà di ispirarsi a tendenze passate nasce DESIGN'A'BILLY.

Oggetti di design che si rifanno agli anni '50 Americani, ripensati in chiave moderna con una nuova tecnologia. Un'ispirazione diretta ed emozionale espressa da un forte senso di ironia sia tramite colori impattanti, sia dalle rifiniture complesse.

Un'interpretazione pop con uno stile dal carattere trasversale, che si adatta a numerose atmosfere. Progettata con uno stile giocoso e coinvolgente, questa collezione rappresenta quelle persone il cui senso artistico non ha rigore né formalità.

A different approach from the usual design, where you go beyond the object itself, seeing in it some stories to tell.

The will to be inspired by past trends brings to life DESIGN'A'BILLY. Design objects that refer to the American '50s, restyled in a modern way by means of a new technology. A direct and emotional inspiration expressed by a strong sense of irony through impactful colors and complex finish. A pop interpretation with a style from the cross-cutting nature, which is suitable for many atmospheres.

Designed in a playful and engaging style, this collection represents people whose artistic sense has neither rigor nor formalities.

INDEX / INDEX

FURNISHINGS

WINTERTREE

META

DANGO

AMEBA

JACK

105

107

117

129

141

149

TECHNICAL SHEETS

177

177

177

178

178

179

FURNI SHINGS

OGGETTI MERAVIGLIOSAMENTE CONCEPITI PER VIVERE DELLA PROPRIA IDENTITÀ COME SINGOLI PEZZI, SEMPRE IN GRADO DI RIPENSARE LO SPAZIO CIRCOSTANTE. OGGETTI DI USO QUOTIDIANO RICONSIDERATI IN UNA PROSPETTIVA DI STUPORE. OSSERVATI DA UN PUNTO DI VISTA DIVERSO. SORPRESA.

OBJECTS MARVELOUSLY DESIGNED TO LIVE OF THEIR OWN IDENTITY AS INDIVIDUAL PIECES, ALWAYS ABLE TO RETHINK THE SURROUNDING SPACE. EVERYDAY OBJECTS RECONSIDERED IN A PERSPECTIVE OF AMAZEMENT, WATCHED BY A DIFFERENT POINT OF VIEW. SURPRISE.

Wintertree,
Meta,
Dango,
Ameba,
Jack



WINTERTREE

resina sintetica, laccatura con vernici atossiche | synthetic resin, lacquering with non-toxic paints
Bookshelf **COD. BOB30D5**

INDOOR / RESIDENTIAL / CONTRACT

UNA LIBRERIA CHE NASCE SENZA ALCUN COMPROMESSO.

Dallo studio dei giovani creativi di 21st Design Lab prende vita una suggestione. Ricreare un oggetto che ha una funzione precisa prendendo le mosse dalla forma naturale per eccellenza: l'albero. Qualsiasi oggetto creato diviene autentico se rimane fedele alla sua funzione, a quel punto diviene oggetto industriale al più alto livello. La sua bellezza nasce dalla sua essenza, una durata infinita inattaccabile dalle mode, quasi la sintesi di un pensiero greco che si cala in una progettualità classica. Partendo da queste riflessioni 21st ha creato WINTERTREE. La forma stilizzata dell'albero ospita oggetti, libri, ricordi in una forma originale che non è vincolata dall'arredamento in cui viene inserita e vive nel suo isolamento all'interno di contesti consueti o desueti. WINTERTREE è una scultura che ha una funzione. Il recupero di forme naturali è sempre attuale nella produzione 21st, molte forme della collezione rappresentano una chiara reinterpretazione delle suggestioni della terra. È proprio in questo contesto che si innesta l'altro elemento della ricerca formale dell'azienda: il colore. Esso si fonde con il design e genera un arredo per la casa di grande creatività ed originalità. La laccatura dona agli oggetti una superficie straordinariamente liscia e vellutata, una fusione tra tecnologia e poesia che rievoca i temi tipici della tradizione dell'interior decoration. Il colore dunque conferisce l'ultima spinta di personalità ad un oggetto pronto per essere protagonista.

A BOOKSHELF CREATED WITHOUT COMPROMISE.

From the studio of the young designers of 21st Design Lab an idea comes to life. An object with a precise function is recreated by emulating the movements of the most quintessential form of nature: the tree. Any creation can be considered authentic if it remains faithful to its function. This is the moment when the creation becomes an industrial object of the highest level. Its beauty comes from its essence, a timelessness that is unaffected by trends, like the synthesis of a Greek thought channeled into a classical design. As a result of these considerations, 21st has created WINTERTREE. This stylized form of the tree holds objects, books and memories in an original shape that is not limited by its surroundings and is equally at home in both usual and unusual contexts. WINTERTREE is a sculpture with a function. 21st's production is always ready to utilize natural forms, in fact many items within the collection represent a clear reinterpretation of ideas inspired by the earth. Within this context, we find the other main element of structured research within the company: colour. This concept merges with design resulting in home interiors that are both creative and original. Lacquer provides the objects with a surface that is extraordinarily smooth and velvety, a fusion between technology and poetry that recalls the archetypal themes of traditional interior decoration. Colour imparts the last impulse of personality to an object that is ready to take on the role of protagonist.









WARHOL
O2A
WARHOL
O2B
WARHOL
STORE AND SHIP
THIS SIDE
WARHOL

60
All-American Ads
50
All-American Ads
40
All-American Ads
30
All-American Ads









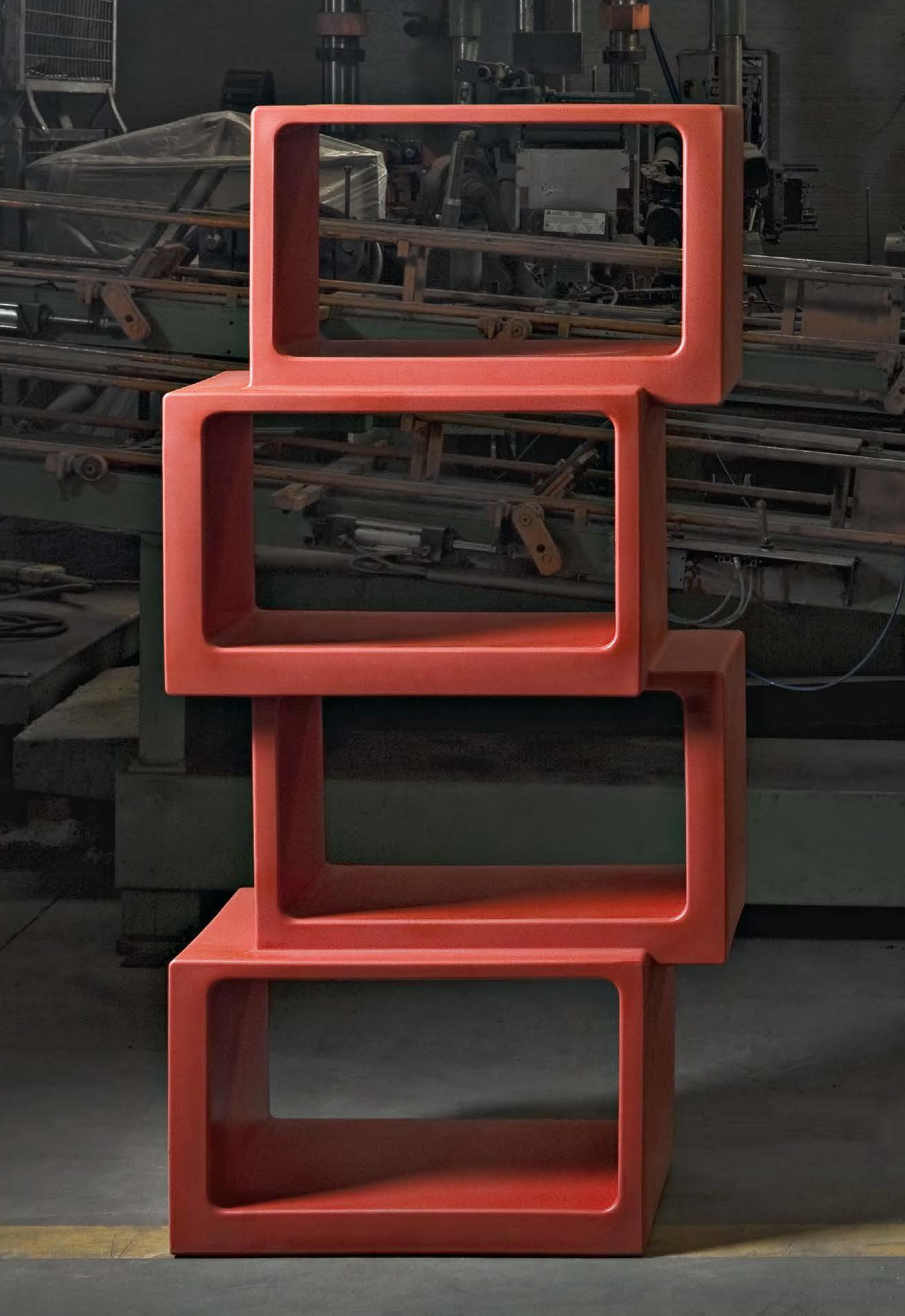

Design: Mario Mazzer
Libreria | Bookshelf

META

polietilene riciclabile | recyclable polyethylene

Bookshelf **COD. BOBB570**

INDOOR / OUTDOOR / RESIDENTIAL / CONTRACT

META è una libreria, il traguardo di un libro dall'autore al lettore. A volte l'eccezionalità di un oggetto sta nell'idea progettuale, nella novità, nella funzione o nei nuovi comportamenti che esso induce. In questo caso Mario Mazzer crea per Twentyfirst una libreria dall'aspetto solido e sobrio. La sovrapposizione, a parziale compenetrazione e traslazione di tre parallelepipedi frontalmente cavi, è caratterizzata da una forma asimmetrica, dinamica e di forte personalità. Un progetto dunque che coniuga forme geometriche ma sinuose e alta tecnologia. E' ottenuta da uno stampaggio rotazionale e disponibile in diversi colori.

META is a bookcase. It is like a finish line that connects the author with the reader. Sometimes the exceptional nature of an object lies in the initial idea, its novelty, its function, or the new behaviours that are brought about by it. In this case, Mario Mazzer has created a solid and serious bookcase for Twentyfirst. The overlap, and partial penetration and transferring of three parallelepiped shapes, which are hollow in the front, has an asymmetrical, dynamic shape with a strong personality. It is, therefore, a design that mixes geometry and curves with high technology. The product is obtained by a rotating moulding and available in different colours.



BO
OK
CASE





DYNAMIC SHAPE
WITH A STRONG
PERSONALITY









A DESIGN THAT MIXES
GEOMETRY AND CURVES
WITH HIGH TECHNOLOGY









Design: Italo Pertichini
Appendiabiti | Coat stand

DANGO

polietilene riciclabile | recyclable polyethylene

Coat-stand **COD. BOB60A5**

INDOOR / OUTDOOR / RESIDENTIAL / CONTRACT / LIGHT OPTIONAL

DESIGN BRIOSO

Dalla collaborazione con il Designer Italo Pertichini nasce questo oggetto di uso comune ma dalle forme originali. Il movimento di rotazione ascensionale dato dalla particolare forma delle spirali costituisce l'architettura di questo oggetto. DANGO è un progetto di architettura urbana trasferito nel salotto di casa. Pratico, funzionale, decorativo, grazie alla sua forma distintiva ed alla varietà di colori disponibili, questo oggetto decorativo ben si presta sia per l'indoor che per l'outdoor.

AMUSING DESIGN

This common object by the original forms comes from the collaboration with the italian designer Italo Pertichini. The upward rotation movement given by the particular shape of the spirals constitute the architecture of this object. DANGO is an urban architectural project moved into the living room. Practical, functional, decorative, due to its distinctive shape and the variety of available colors, this decorative object is well suited both for the indoor and for the outdoor.











A NEW FURNISHING SOLUTION FOR YOUR LIVING SPACES





CLOTHES STAND

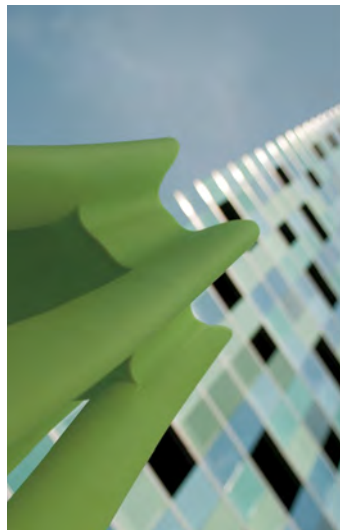







TWENTYFIRST

Design: CrousCalogero
Portabottiglie | Bottle rack

AMEBA

polietilene riciclabile | recyclable polyethylene

Bottle rack **COD. BOC0250**

INDOOR / OUTDOOR / RESIDENTIAL / CONTRACT

PORTABOTTIGLIE MODULARE IN POLIETILENE

AMEBA è un portabottiglie modulare con maniglia per il trasporto. Come singolo pezzo AMEBA è un regalo molto intelligente e utile per gli amici, un portabottiglie divertente per colorare e vivacizzare feste all'aperto; nella sua composizione modulare AMEBA diventa un grazioso oggetto di design per decorare un angolo del vostro spazio o anche un muro. Adatto per i settori Casa e Horeca. Pratica, divertente, intelligente.

MODULAR BOTTLE RACK IN POLYETHYLENE

AMEBA is a modular bottle rack with carrying handle. As single piece AMEBA is a very smart and useful present for friends, or maybe a funny bottle rack to color and spice up outdoor parties; in its modular composition AMEBA becomes a pretty design object to decorate a corner of your living space or even a wall. Suitable for Home and Horeca. Practical, fun, smart.







AMEBA BOTTLE RACK





PRACTICAL, FUN, SMART



AMEBA GIFT PACK



Design: Marco Cocco
Lampada da terra / tavolo | Floor / table lamp

JACK

polietilene riciclabile | recyclable polyethylene

Lamp/Pumpkin **COD. BOBG020**

INDOOR / OUTDOOR / RESIDENTIAL / CONTRACT / LIGHT OPTIONAL

UN'IDEA BRILLANTE PER ILLUMINARE CON STILE

JACK, l'allegria zucca diventa una simpatica lampada ideale per la cameretta dei bambini o in cucina, ma anche spiritosa e divertente per illuminare una festa in giardino. Nella versione a led RGB JACK è capace di creare dei giochi di luce molto suggestivi e colorati. Il pratico manico a gancio favorisce la presa della lampada per spostare facilmente il punto luce ed appenderlo in sospensione. Adatto per la casa ed il settore Horeca.

A BRILLIANT IDEA TO ILLUMINATE IN STYLE

JACK, the cheerful pumpkin becomes a nice lamp ideal for the children's room or in the kitchen, it's also witty and fun to brighten up a garden party. In LED RGB version JACK is able to create very striking and colorful light effects. The practical handle hook facilitates the taking of the lamp to easily move it and hang it in suspension. Suitable for home and Horeca sector.

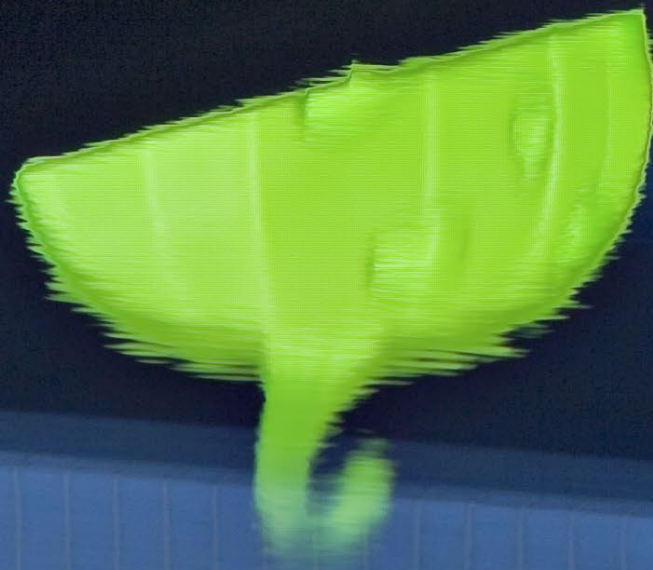





LAMP
/PUMPKIN







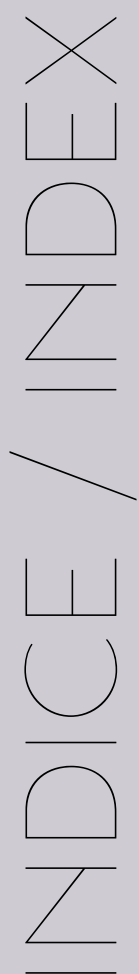

TECHNICAL SHEETS

POLIETILENE: CARATTERISTICHE
POLYETHYLENE: FEATURES

DRESSED COLLECTION COLOURS

NUDE COLLECTION COLOURS

LIGHTING COLLECTION COLOURS

LIGHTING KIT INDOOR / OUTDOOR

GROOVE ACCESSORIES:
OUTDOOR CUSHIONS

OPTIONALS AMEBA

KIT PIASTRA DI ANCORAGGIO
ANCHOR PLATE KIT

CHAIRS & TABLES

ANGELICA & ORLANDO

GROOVE COLLECTION

TOM & DAISY

DODÒ & NANÀ

PACIFICO & BEATO

SERENO

HHC

JOHN

SWAP

DESIGN 'A 'BILLY
(JOE STOOL & BOB TABLE)

FURNISHINGS

WINTERTREE

META

DANGO

AMEBA

JACK

157

159

160

161

162

163

164

166

167

168

172

168 /169

170

171

174

175

173

173

175

176

177

177

177

178

178

179

TECHNICAL SHEETS

TWENTYFIRST
design from a new century

POLIETILENE POLYETHYLENE

CARATTERISTICHE / FEATURES

VANTAGGI DEI PRODOTTI ROTOSTAMPATI

Tecnologia sostenibile: nel processo produttivo non vengono impiegati solventi inquinanti

Ecologici: sono ottenuti con materie prime inerti e riciclabili

Leggeri: facili da movimentare per una rapida riorganizzazione dello spazio

Manutenzione minima: si puliscono rapidamente e facilmente

Resistenti agli agenti atmosferici: sopportano improvvisi sbalzi termici da -30 ° C a + 50 ° C

Robusti e resistenti agli urti

Resistenti ai raggi U.V.

Di lunga durata

Ottimo rapporto qualità-prezzo

ADVANTAGES OF ROTO-MOLDED PRODUCTS

Sustainable: no polluting solvents are employed during the production process

Ecological: they are obtained with inert and recyclable raw materials

Lightweight: easy to handle for fast reorganization of space

Minimal maintenance: can be cleaned quickly and easily

Weather resistant: bear sudden thermal excursions from -30° C to + 50° C

Robust and shock resistant

U.V. Resistant

Long lasting

Excellent value for money

PULIZIA CLEANING

Per la pulizia utilizzare un panno morbido. Evitare prodotti che contengono solventi. Pulire la superficie con acqua tiepida o detersivi liquidi neutri, diluiti in acqua. Sciacquare abbondantemente. Non utilizzare utensili o spazzole a setole dure che potrebbero danneggiare la superficie.

For the cleaning use a soft cloth. Do not use products containing solvents. Clean the surface with warm water or neutral detergents, diluted in water. Rinse thoroughly. Never use tools or hard bristle brushes which might damage the surface.

AVVERTENZE WARNING

Il produttore declina ogni responsabilità per danni causati a cose o a persone derivanti da uno scorretto utilizzo o dalla manomissione del prodotto. E' severamente vietato fare un uso improprio del prodotto. Il mancato rispetto può causare danni materiali o lesioni personali.

Our company shall not be held responsible for any injury to person(s), or for any damage to things, consequent on incorrect use of this item or tampering with the same. It is strictly forbidden to make improper use of the product. Failure to comply may result in personal injury or damages.

DR ES SED

COLLECTION

La versione più esclusiva, lussuosa, pregiata. Una finitura superficiale, la laccatura, che dona alla forma una brillantezza preziosa; la sua lavorazione è un'arte, un lavoro artigianale "hand-made", dove piccole irregolarità del lavoro umano diventano caratteristiche che rendono unico ogni singolo pezzo. I colori BASIC (bianco, nero, crema, rosso) sono dei pastelli lucidi; i colori PLUS (bronzo, moonlight, chocolate, prugna, rosa charme) sono caratterizzati da riflessi perlati e metallizzati che esaltano la forma dell'oggetto: il colore diventa protagonista assoluto. Particolarmente adatta ad ambienti interni e contract, la versione dressed si presta ad installazioni opendoor protette dalle intemperie dirette.

Lacquered shapes. It is the most exclusive, luxurious, and refined version. The surface lacquer gives the object a rich brilliance. The technique that is used is a true art form: it is hand-made artisanship at its finest, where small irregularities become characteristics that make each single piece unique. The BASIC colours (white, black, cream, and red) are shiny. The PLUS colours (bronze, moonlight, chocolate, prune, pink charme) have pearlised and metallic characteristics that bring out the shape of the object. The colour becomes the true star of the show. Particularly ideal for indoor and contract spaces, the "dressed" version works very well in opendoor areas where it is not directly exposed to the elements.

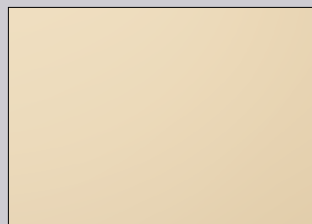

Basic

CREAM

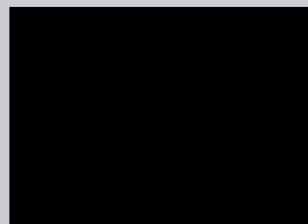

Basic

BLACK

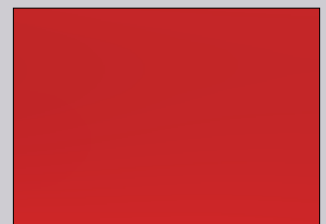

Basic

RED

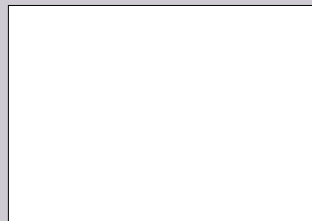

Basic

WHITE

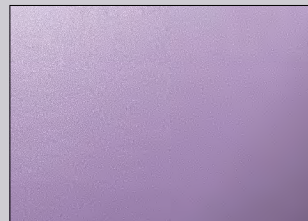

Plus

PINK CHARME

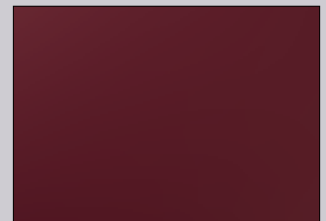

Plus

PRUNE

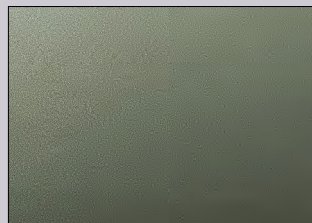

Plus

MOONLIGHT

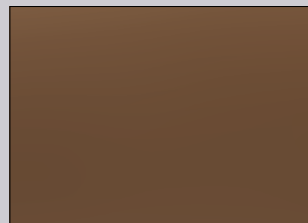

Plus

BRONZE

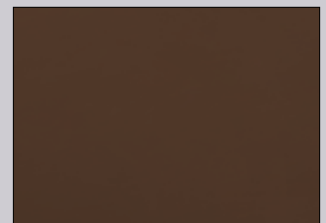

Plus

CHOCOLATE

NU DE COLLECTION

Forme in polietilene colorato in estrusione. Una versione semplice, versatile, resistente agli urti, ai raggi u.v. ed agli sbalzi termici. Particolarmente adatta per le installazioni outdoor, briosa e dilettevole nelle installazioni indoor. Lavabile, pronta all'uso ed al massimo sfruttamento senza limiti.

Shapes made of extruded coloured polyethylene. A version that is simple, versatile, resistant to shocks, UV rays, and changes in weather. Particularly ideal for outdoor installations, but lively and fun indoors. Washable and ready for use, without limits.

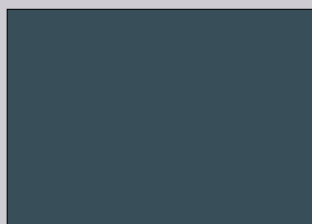

ANTHRACITE

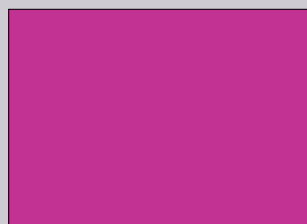

PURPLE

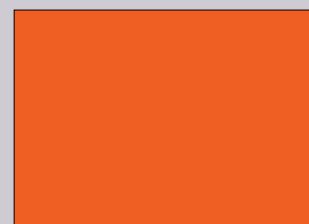

ORANGE

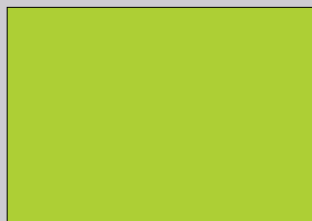

GREEN

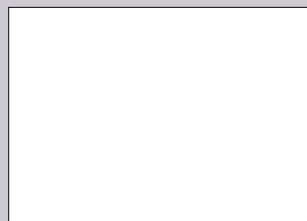

WHITE | NEUTRAL

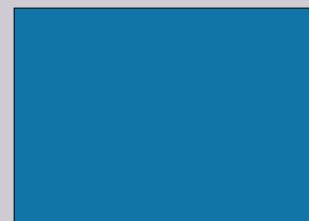

AVIATOR

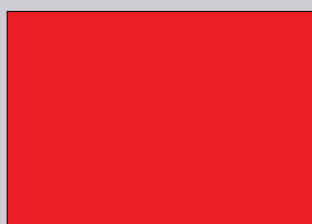

RED

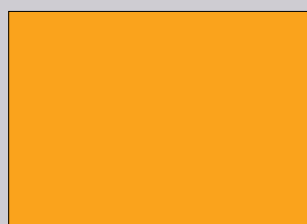

MANDARIN

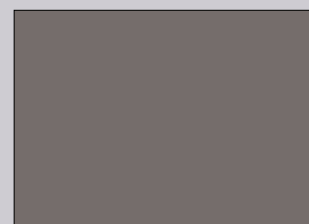

TURTLEDOVE

LIGHTING COLLECTION

Forme illuminate. La versione nude è impreziosita dalla luce che, posizionata all'interno dell'oggetto, crea atmosfere suggestive sia indoor che outdoor. Il kit di illuminazione è certificato CE e disponibile in versione sia indoor che outdoor.

Illuminated shapes. The nude version is enriched with a light source that is housed inside the object. It creates an evocative ambience both indoors as well as outdoors. The lighting kit is CE certified and available for indoor and outdoor use.

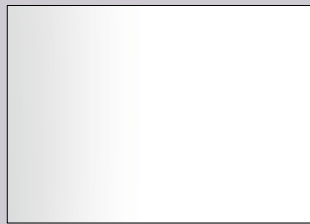
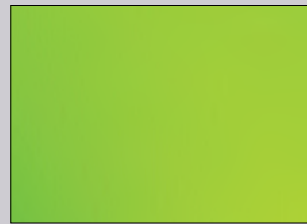
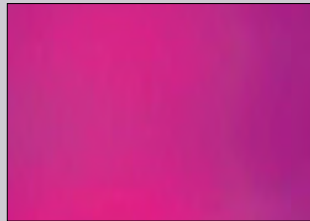
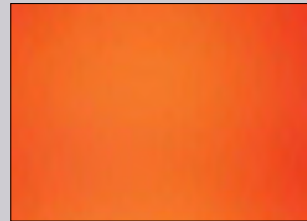
**NEUTRAL****GREEN****ORANGE****PURPLE**

LIGHTING KIT

INDOOR / OUTDOOR

LAMPADINA Modello a fluorescenza compatta | Risparmio Energetico | Classe A | Potenza max 23 watt
LED (bianco freddo) | Classe A+ | Potenza max 10 watt
LED RGB (WI-FI LED RGB Full color + White) | Potenza max 9 watt

BULB Compact fluorescent lamp | Energy Saving | Class A | Power max 20 watt
LED (cold white) | Class A+ | Power max 10 watt
LED RGB (WI-FI LED RGB Full color + White) | Power max 9 watt

**TELECOMANDO
(SOLO PER LED RGB)** Telecomando a Radio Frequenza per 4 zone indipendenti;
Funzione dimmer;
Sincronizzabile con altri ricevitori dello stesso modello;
Raggio d'azione: 25 metri.

**REMOTE CONTROLLER
ONLY FOR RGB LED KITS** RF remote controller for 4 independent zones;
Dimming function;
Synchronizing with other receivers of the
same model;
Emitting signal: 25 meters.

**CAVO PER INDOOR
INDOOR CABLE** Cavo trasparente con pulsante a pedale | Spina tipo bipolare europea 2,5A | 250V
Transparent cable with pedal push button | European bipolar plug 2,5A | 250V

**CAVO PER OUTDOOR
OUTDOOR CABLE** Cavo nero in neoprene a doppio isolamento | spina tipo schucko 10A | 250V
Black neoprene cable with double insulation | Schucko plug 10A | 250V

**GRADO DI PROTEZIONE IP*
DEI KIT ILLUMINAZIONE**

INDOOR
IP 20:
Protezione contro la penetrazione di corpi solidi superiori a 12 mm
Nessuna protezione contro la penetrazione di liquidi

OUTDOOR
IP 44 (con spina schucko fornita premontata):
Protezione contro la penetrazione di corpi solidi superiori a 1 mm (polvere);
Protezione contro la penetrazione di liquidi come: vapore, gocce, pioggia e spruzzi d'acqua.
IP 67 (con installazione kit IP 67 in dotazione):
Protezione contro la penetrazione di corpi solidi e polveri
Protezione contro l'immersione momentanea in acqua.
** Il grado di protezione IP è garantito e riferito al kit illuminazione fornito ed installato all'interno di un prodotto TWENTYFIRST. La garanzia non è valida sul singolo componente elettrico isolato.*

**IP PROTECTION INDEX*
OF THE LIGHTING KIT**

INDOOR
IP 20 :
Protection against penetration of solid matters larger than 12 mm
No protection against penetration of liquids

OUTDOOR
IP 44 (with pre-installed schucko plug):
Protection against the penetration of solid matters larger than 1 mm (dust);
Protection against the penetration of fluids such as vapour, drops, rain and water sprays.
IP 67 (with installation of the supplied IP 67 kit):
Total protection against the penetration of solid matters and dust;
Protection against temporary soak in water.
** The IP protection index is only guaranteed and referred to the lighting kit when installed inside a TWENTYFIRST product. Warranty is not applicable on the sole electric components.*



MODEL

TECHNICAL DATA

KIT INDOOR 230/240V 50Hz Class II IP20

KIT OUTDOOR 230/240V 50Hz Class II IP44 / IP67

UL KIT (INDOOR/ OUTDOOR) 110V / socket E26 **available on request**

GROOVE ACCESSORIES: OUTDOOR CUSHIONS

SOFA, ARMCHAIR

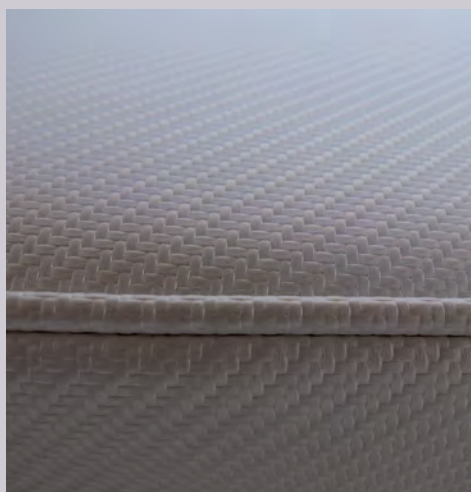

fig. 1



fig. 2



fig. 3

CUSCINO SINGOLO PER POLTRONA CUSCINO DOPPIO PER SOFA

COMPOSIZIONE:

Cuscino in poliuretano morbido, spessore 6 cm circa (fig. 1); Rivestimento in tessuto tecnico antigraffio per esterni, superficie a trama intrecciata colore bianco perlato, bordo cordonato (fig. 1); Chiusura a lampo in tinta; Rete traspirante inferiore (fig. 2); Fissaggio del cuscino con fettuccia in tessuto e bottone automatico inox (fig. 3). Di notevole resistenza a graffi, raggi u.v. e basse temperature, il rivestimento in vinile è impermeabile, lavabile, ritardante al fuoco.

PULIZIA:

Resistente a graffi, abrasioni e logorio, il rivestimento è di facile manutenzione. Basta un panno asciutto per eliminare le macchie superficiali; per lo sporco più ostinato si consiglia l'impiego di qualche goccia di alcool isopropilico.

MANUTENZIONE E CURA:

Il rivestimento del cuscino deve essere pulito regolarmente per mantenere integro il suo aspetto e prevenire la formazione di depositi di sporco e di agenti contaminanti. Eliminare prontamente qualsiasi macchia o sporco per evitare che diventino permanenti. Pulire con un semplice panno bianco inumidito con acqua e saponi o detersivi neutri specifici per tessuti in vinile. Detersivi aggressivi e solventi chimici possono danneggiare il tessuto, deteriorandolo. Alcuni coloranti di vestiti o accessori (p.e. jeans) possono migrare verso colori più chiari. Questo fenomeno si accentua con l'umidità ed il calore, ed è irreversibile. Si consiglia pertanto la massima attenzione. Queste informazioni non rappresentano una garanzia e non esonerano l'utente dalla responsabilità dell'uso corretto e sicuro del prodotto e tutti gli agenti di pulizia.

SINGLE CUSHION FOR ARMCHAIR DOUBLE CUSHION FOR SOFA

COMPOSITION:

Soft polyurethane cushion 6 cm thick (fig. 1); Technical fabric for outdoor use, scratch resistant, braid textured surface, white pearl color, slotted edge (fig. 1); Bottom breathable mesh fabric (fig. 2); Zips in hue; Cushion fastener made of fabric webbing with stainless steel snap (fig. 3). With considerable resistance to scratches, u.v. rays and low temperatures, the vinyl fabric is waterproof, washable, flame retardant.

CLEANING:

Resistant to scratches, abrasion and wear and tear, the coating is easy to maintain. Use just a dry cloth to remove surface stains; For stubborn dirt we recommend the use of a few drops of isopropyl alcohol.

CARE AND MAINTENANCE:

The cushion coating has to be cleaned regularly to keep intact its appearance and prevent the formation of deposits of dirt and contaminants. Remove promptly any stain or dirt to prevent them from becoming permanent. Clean with a simple white cloth dampened with water and neutral soap or detergent specifically for vinyl fabrics. Aggressive cleaning agents and solvents can damage the fabric, compromising it. Some colors of clothes or accessories (e.g. jeans) can migrate towards lighter colors. This phenomenon is accentuated with moisture and heat, and it is irreversible. We therefore recommend the utmost attention. This information is not a guarantee and does not relieve the user from the responsibility of the proper and safe use of the product and all cleaning agents.



OPTIONALS AMEBA

Cod. M012005 00002

Staffa bianca per composizione modulare (L. 648 mm)
White painted bracket for modular system (L. 648 mm)

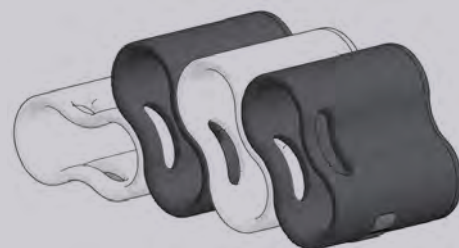
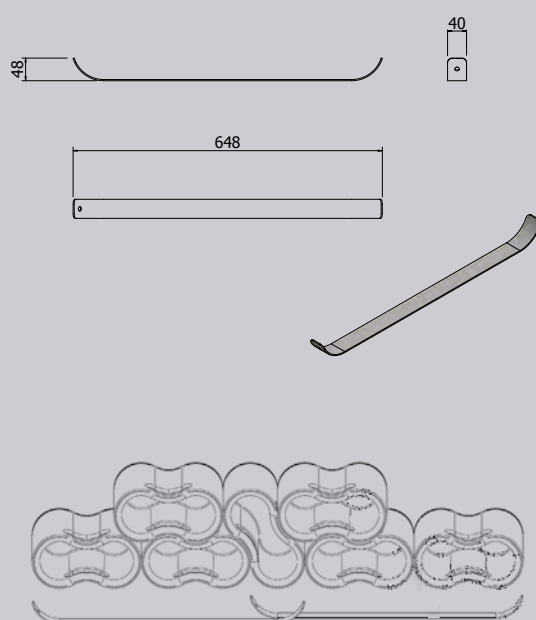

Cod. MOC0251

GIFT PACKAGING: confezione regalo per una singola AMEBA
GIFT PACKAGING: creative carton package for one single AMEBA



KIT PIASTRA DI ANCORAGGIO ANCHOR PLATE KIT

Cod. M052750 V0022

PIASTRA DI ANCORAGGIO IN ACCIAIO INOX
STAINLESS STEEL ANCHOR PLATE

Disponibile per i seguenti modelli
Available for the following models
DODÒ, NANÀ, TOM, DAISY

Cod. M052521 V0022

PIASTRA DI ANCORAGGIO IN ACCIAIO INOX
STAINLESS STEEL ANCHOR PLATE

Disponibile per modello
Available for model
SWAP

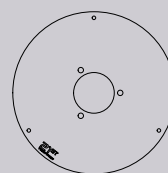

Cod. M052840 V0042

PIASTRA LACCATA PER CENTRO STANZA
FREE STANDING LACQUERED PLATE

WINTERTREE

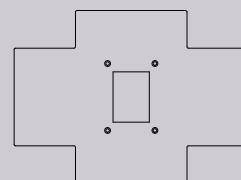

CHAIRS & TABLES

DESIGN: MOREDESIGN
polietilene riciclabile | recyclable polyethylene

GROOVE COFFEE TABLE

COD. BOBE050



INGOMBRO (mm) / OVERALL DIMENSION (mm): 1000 X 660 X 385

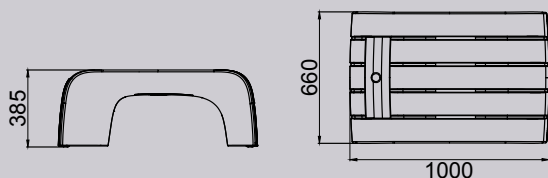

AVAILABLE COLOURS / NUDE (PAG.161)

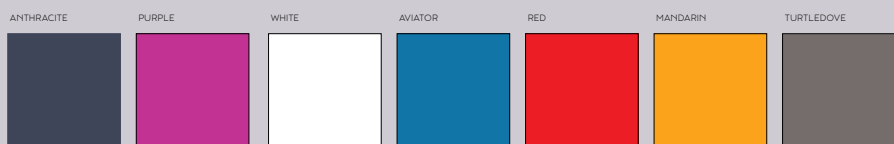

DESIGN: MOREDESIGN
polietilene riciclabile | recyclable polyethylene

GROOVE ARMCHAIR

COD. BOBE047



INGOMBRO (mm) / OVERALL DIMENSION (mm): 980 X 705 X 735

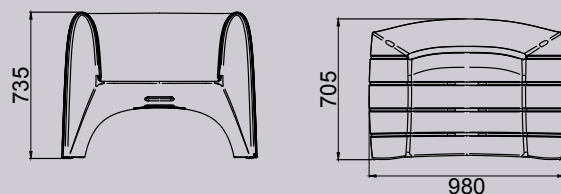

OPTIONAL
CUSCINO BIANCO PERLATO PER OUTDOOR
OUTDOOR PEARL WHITE CUSHION

AVAILABLE COLOURS / NUDE (PAG.161)

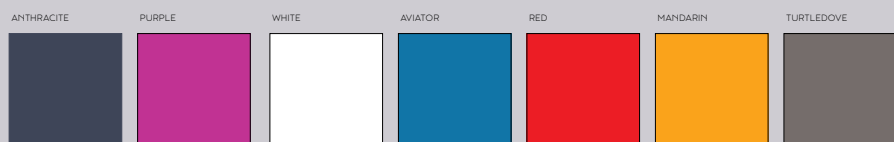

CHAIRS & TABLES

DESIGN: MOREDESIGN

polietilene riciclabile | recyclable polyethylene

GROOVE SOFA

COD. BOBE095



Indoor



Outdoor



Residential



Contract



Pieces per Packaging



Recyclable

INGOMBRO (mm) / OVERALL DIMENSION (mm): **1570 X 715 X 735**

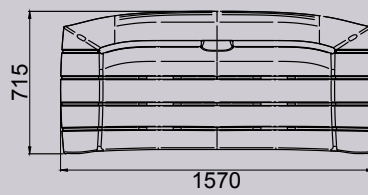
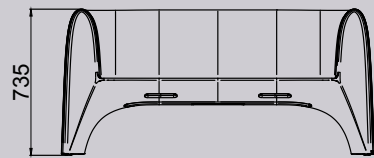

OPTIONAL
CUSCINO BIANCO PERLATO PER OUTDOOR
OUTDOOR PEARL WHITE CUSHION

AVAILABLE COLOURS / NUDE (PAG.161)

ANTHRACITE



PURPLE



WHITE

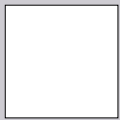

AVIATOR



RED

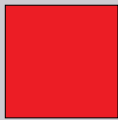

MANDARIN



TURTLEDOVE



CHAIRS & TABLES

DESIGN: STUDIO THESIA PROGETTI
polietilene riciclabile | recyclable polyethylene

TOM COFFEE TABLE

COD. BOBH023



INGOMBRO (mm) / OVERALL DIMENSION (mm): 640 X 435 X 455

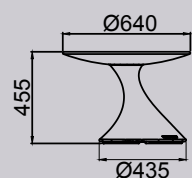

FORO SUL FONDO PER RIEMPIMENTO CON
SABBIA O ALTRO MATERIALE ZAVORRA
HOLE AT BOTTOM FOR FILLING WITH SAND
OR OTHER BALLAST MATERIAL

AVAILABLE COLOURS / NUDE (PAG.161)



DESIGN: STUDIO THESIA PROGETTI
polietilene riciclabile | recyclable polyethylene

DAISY ARMCHAIR

COD. BOBH037



INGOMBRO (mm) / OVERALL DIMENSION (mm): 715 X 540 X 720

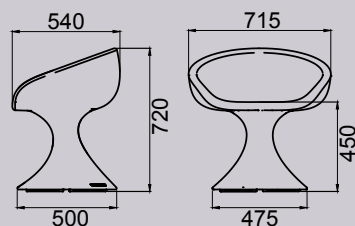

FORO SUL FONDO PER RIEMPIMENTO CON
SABBIA O ALTRO MATERIALE ZAVORRA
HOLE AT BOTTOM FOR FILLING WITH SAND
OR OTHER BALLAST MATERIAL

AVAILABLE COLOURS / NUDE (PAG.161)



CHAIRS & TABLES

DESIGN: STUDIO THESIA PROGETTI
 polietilene riciclabile | recyclable polyethylene

DODÒ STOOLBAR
 COD. BOB8040



INGOMBRO (mm) / OVERALL DIMENSION (mm): **470 X 415 X 725**

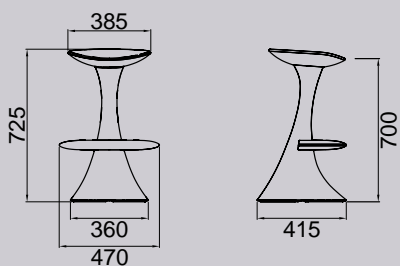

FORO SUL FONDO PER RIEMPIMENTO CON
 SABBIA O ALTRO MATERIALE ZAVORRA
 HOLE AT BOTTOM FOR FILLING WITH SAND
 OR OTHER BALLAST MATERIAL

AVAILABLE COLOURS / NUDE (PAG.161)



DESIGN: STUDIO THESIA PROGETTI
 polietilene riciclabile | recyclable polyethylene

NANÀ HIGH TABLE
 COD. BOB9055



INGOMBRO (mm) / OVERALL DIMENSION (mm): **645 X 645 X 1045**

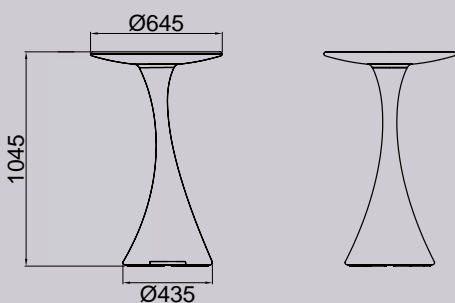

FORO SUL FONDO PER RIEMPIMENTO CON
 SABBIA O ALTRO MATERIALE ZAVORRA
 HOLE AT BOTTOM FOR FILLING WITH SAND
 OR OTHER BALLAST MATERIAL

AVAILABLE COLOURS / NUDE (PAG.161)



CHAIRS & TABLES

DESIGN: MOREDESIGN
polietilene riciclabile | recyclable polyethylene

ANGELICA CHAIR

COD. BOBF025



INGOMBRO (mm) / OVERALL DIMENSION (mm): **H 880 X 615 X 610**

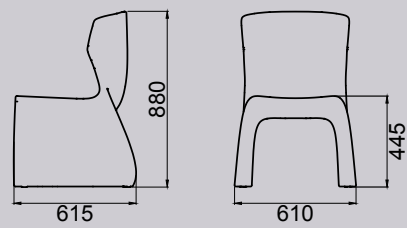

AVAILABLE COLOURS / NUDE (PAG.161)



DESIGN: MOREDESIGN
polietilene riciclabile | recyclable polyethylene

ORLANDO COFFEE TABLE

COD. BOBF047



INGOMBRO (mm) / OVERALL DIMENSION (mm): **H 485 X 820 X 935**

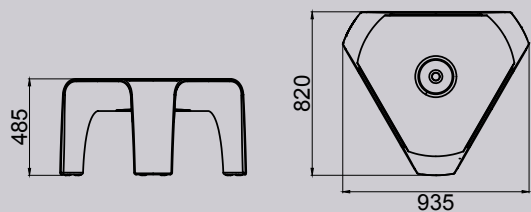

AVAILABLE COLOURS / NUDE (PAG.161)

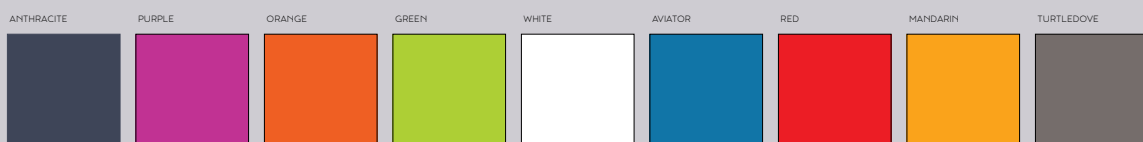

CHAIRS & TABLES

DESIGN: MARIO MAZZER
polietilene riciclabile | recyclable polyethylene

JOHN CHAIR

COD. BOBC040



INGOMBRO (mm) / OVERALL DIMENSION (mm): **450 X 635 X 780**

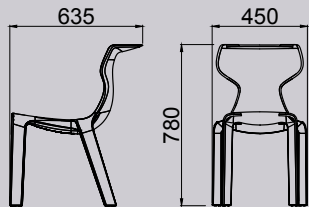

AVAILABLE COLOURS / NUDE (PAG.161)



DESIGN: MARCO COCCO
polietilene riciclabile | recyclable polyethylene

HHC LOUNGE SYSTEM

COD. BOBBO20



INGOMBRO (mm) / OVERALL DIMENSION (mm): **1350 x 1350 x 410**

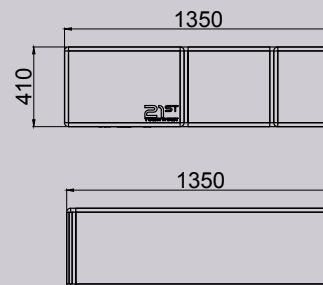
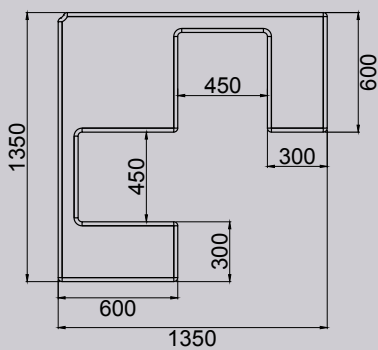

OPTIONAL
LIGHTING KIT INDOOR (IP20) ●
LIGHTING KIT OUTDOOR (IP44 / IP67) ●

AVAILABLE COLOURS / NUDE (PAG.161)



COMPOSITION EXAMPLE

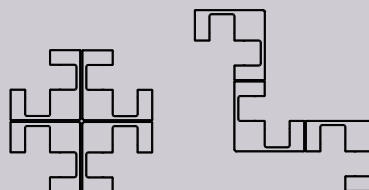

DESIGN: MOREDESIGN
polietilene riciclabile | recyclable polyethylene

PACIFICO TABLE

COD.BOBA528



INGOMBRO (mm) / OVERALL DIMENSION (mm): **1015 x 755 x 530**

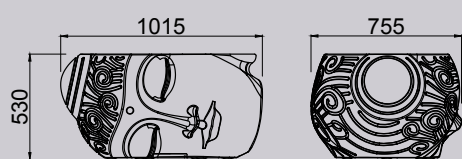

OPTIONAL
LIGHTING KIT INDOOR (IP20) ●
LIGHTING KIT OUTDOOR (IP44 / IP67) ●

AVAILABLE COLOURS / NUDE (PAG.161)



DESIGN: MOREDESIGN
polietilene riciclabile | recyclable polyethylene

BEATO POUF

COD.BOBA023



INGOMBRO (mm) / OVERALL DIMENSION (mm): **515 x 490 x 455**

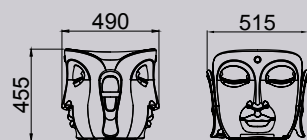

FORO PER CATENA | CHAIN HOLE

OPTIONAL
LIGHTING KIT INDOOR (IP20) ●
LIGHTING KIT OUTDOOR (IP44 / IP67) ●

AVAILABLE COLOURS / NUDE (PAG.161)



CHAIRS & TABLES

DESIGN: MOREDESIGN
polietilene riciclabile | recyclable polyethylene

SERENO ARMCHAIR | TOTEM

COD. BOBB585



INGOMBRO (mm) / OVERALL DIMENSION (mm): **1000x990x1485**

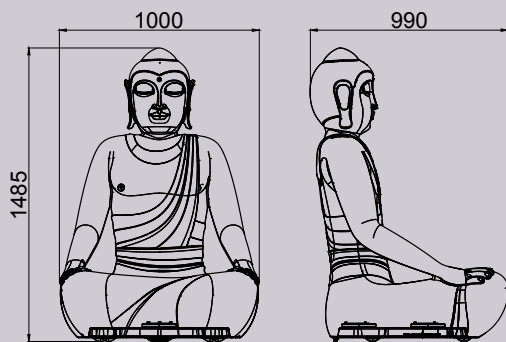

OPTIONAL
LIGHTING KIT INDOOR (IP20) ●
LIGHTING KIT OUTDOOR (IP44 / IP67) ●

SERENO PUO' OSPITARE UNO o DUE KIT ILLUMINAZIONE
SERENO CAN HOUSE ONE or TWO LIGHTING KITS

AVAILABLE COLOURS / NUDE (PAG.161)



DESIGN: CROUSCALOGERO
polietilene riciclabile | recyclable polyethylene

SWAP UPSIDE DOWN LAMP

COD. BOC2025



INGOMBRO (mm) / OVERALL DIMENSION (mm): **Ø 520x2010**

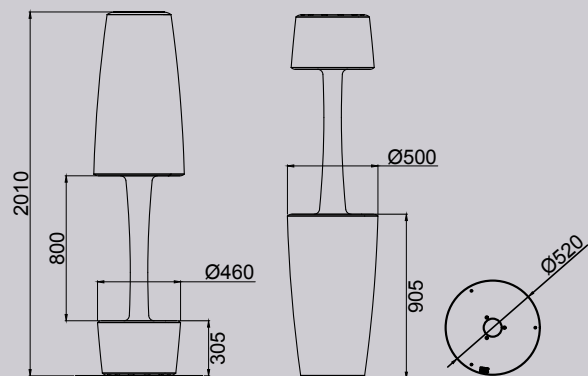

PIASTRA IN ACCIAIO
STAINLESS STEEL PLATE

SWAP È FORNITA DI SERIE CON PIASTRA IN ACCIAIO INOX E KIT ILLUMINAZIONE A LED
SWAP IS STANDARD SUPPLIED WITH STAINLESS STEEL PLATE AND LED LIGHTING KIT

AVAILABLE COLOURS / LIGHTING (PAG.162)

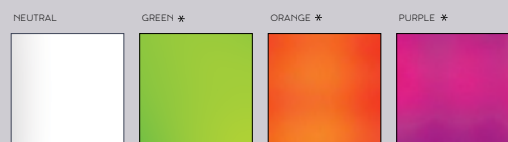

* MIN. 5 PCS PER COLOUR

CHAIRS & TABLES

DESIGN: GRAZIANO MORO E RENATO PIGATTI
polietilene riciclabile | recyclable polyethylene

JOE STOOLBAR

COD. BOBG037



INGOMBRO (mm) / OVERALL DIMENSION (mm): **450 X 450 X 760**

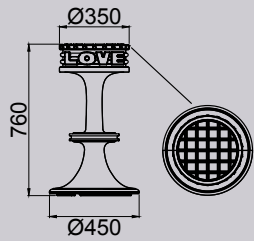

FORO SUL FONDO PER RIEMPIMENTO CON
SABBIA O ALTRO MATERIALE ZAVORRA
HOLE AT BOTTOM FOR FILLING WITH SAND
OR OTHER BALLAST MATERIAL

AVAILABLE COLOURS / NUDE (PAG.161)



DESIGN: GRAZIANO MORO E RENATO PIGATTI
polietilene riciclabile | recyclable polyethylene

BOB HIGH TABLE

COD. BOBG055



INGOMBRO (mm) / OVERALL DIMENSION (mm): **640 X 640 X 1090**

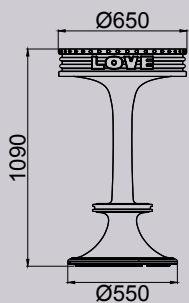

FORO SUL FONDO PER RIEMPIMENTO CON
SABBIA O ALTRO MATERIALE ZAVORRA
HOLE AT BOTTOM FOR FILLING WITH SAND
OR OTHER BALLAST MATERIAL

AVAILABLE COLOURS / NUDE (PAG.161))



FURNISHINGS

DESIGN: TWENTYFIRST DESIGN LAB

resina sintetica, laccatura con vernici atossiche | synthetic resin, lacquering with non-toxic paints

WINTERTREE BOOKSHELF

COD. BOB30D5



INGOMBRO (mm) / OVERALL DIMENSION (mm): 1660 x 320 x 2100

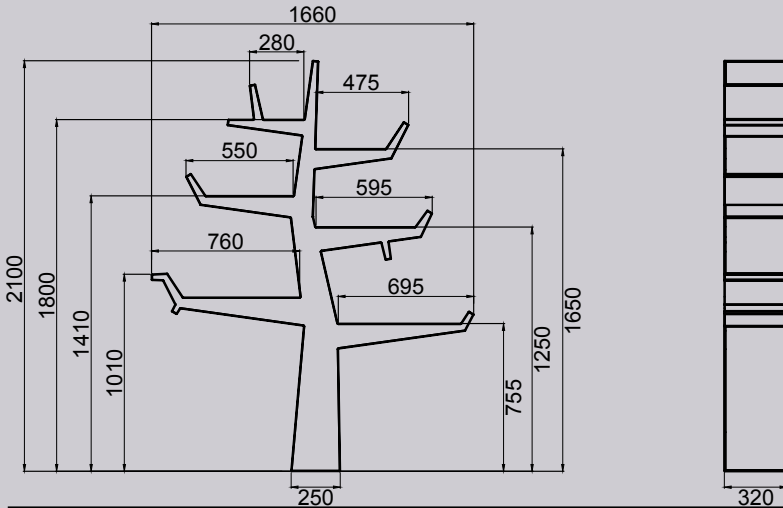

COMPOSITION EXAMPLE

KIT FISSAGGIO A MURO FORNITO DI SERIE
WALL FIXING KIT INCLUDED AS STANDARD

PORTATA MAX
 RIPIANI INFERIORI: 25 KG DISTRIBUITI
 RIPIANI INTERMEDI: 17 KG DISTRIBUITI
 RIPIANI SUPERIORI: 12 KG DISTRIBUITI
MAX LOAD
 LOWER SHELVES: 25 KG DISTRIBUTED
 MIDDLE SHELVES: 17 KG DISTRIBUTED
 UPPER SHELVES: 12 KG DISTRIBUTED

OPTIONAL
 PIASTRA VERNICIATA PER CENTRO STANZA_ M052840
 FREE STANDING LACQUERED PLATE_ M052840

AVAILABLE COLOURS / DRESSED (PAG. 163)



* AVAILABLE COLOURS
 DRESSED (PAG.119 / 121)

DESIGN: MARIO MAZZER

polietilene riciclabile | recyclable polyethylene

META BOOKSHELF

COD. BOBB570



INGOMBRO (mm) / OVERALL DIMENSION (mm): 700 X 360 X 1445

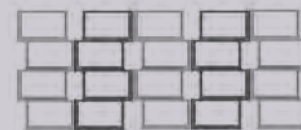
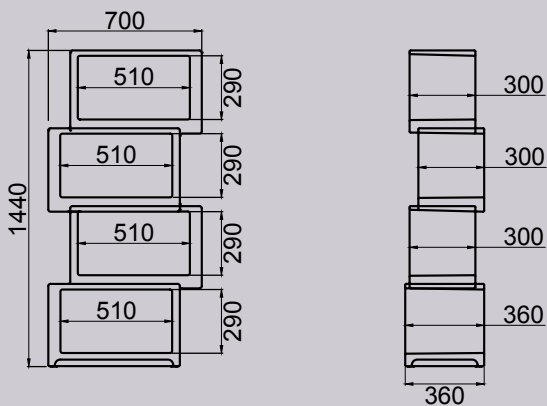

COMPOSITION EXAMPLE

PORTATA MAX
 RIPIANO INFERIORE: 15 KG DISTRIBUITI
 ALTRI RIPIANI: 8 KG DISTRIBUITI
MAX LOAD
 LOWER SHELF: 15 KG DISTRIBUTED
 OTHER SHELVES: 8 KG DISTRIBUTED

AVAILABLE COLOURS / NUDE (PAG.161)

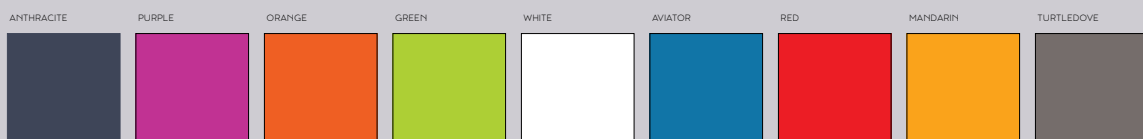

FURNISHINGS

DESIGN: ITALO PERTICHINI
 polietilene riciclabile | recyclable polyethylene

DANGO COAT-STAND

COD. BOB60A5



INGOMBRO (mm) / OVERALL DIMENSION (mm): 600 X 600 X 1685

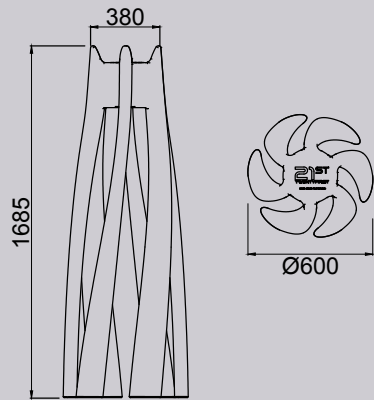

• DANGO LIGHTING INDOOR:
 IL KIT ILLUMINAZIONE (IP20)
 E' FORNITO PREMONTATO
 THE LIGHTING KIT (IP20)
 IS PRE-ASSEMBLED

AVAILABLE COLOURS / NUDE (PAG.161)



AVAILABLE COLOURS / LIGHTING (PAG.162)

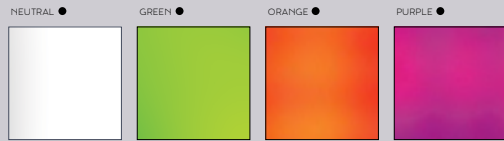

DESIGN: CROUSCALOGERO
 polietilene riciclabile | recyclable polyethylene

AMEBA BOTTLE RACK

COD. BOC0250

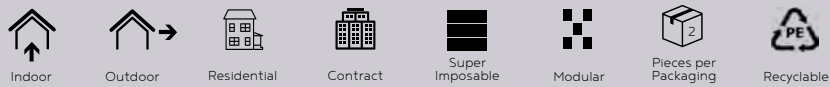

INGOMBRO (mm) / OVERALL DIMENSION (mm): 260 X 130 X 250

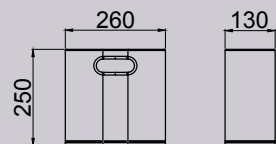

COMPOSITION EXAMPLE

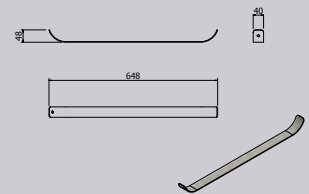
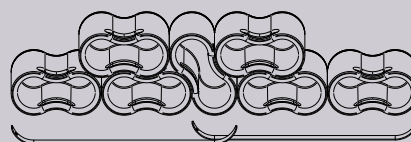

OPTIONAL
 STAFFA VERNICIATA BIANCA
 WHITE PAINTED BRACKET

SINGLE GIFT PACKAGING



AVAILABLE COLOURS / NUDE (PAG.161)

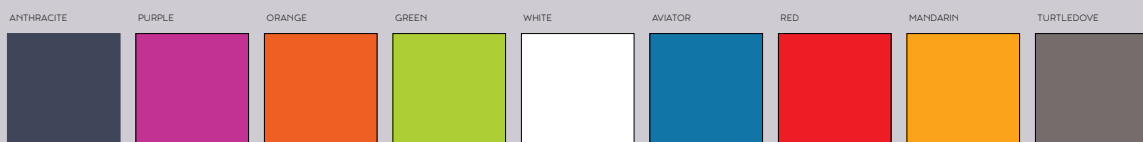

FURNISHINGS

DESIGN: MARCO COCCO
polietilene riciclabile | recyclable polyethylene

JACK LAMP/PUMPKIN

COD. BOBGO20



INGOMBRO (mm) / OVERALL DIMENSION (mm): **Ø 375 X H 410**



OPTIONAL
LIGHTING KIT INDOOR (IP20) ●
LIGHTING KIT OUTDOOR (IP44 / IP67) ●

AVAILABLE COLOURS / LIGHTING (PAG.162)

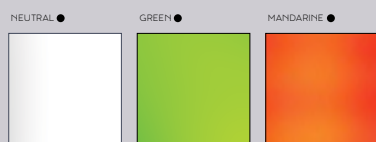

my projects