



Quadrifoglio Group



# Residential & Hospitality Collection



# Quadrifoglio Group. Living and breathing design, everywhere

## **We are Ethics and Vision in the form of Order and Ergonomics.**

**Design Office, Living and Lighting. Three ways of exploring design, united by the quality of the materials, the quest for elaborate finishes and the continuous focus on comfort and wellbeing, as part of an all-Italian identity.**

---

Quadrifoglio Group,  
vivere il design, ovunque

**Siamo Etica e Visione declinate  
in Ordine ed Ergonomia.**

Design Office, Living e Lighting. Tre modi di coniugare il design, accomunati dalla qualità dei materiali, dalla ricerca di finiture elaborate e dalla tensione continua al comfort e al benessere, nel segno di un'identità tutta italiana.



# Our Identity

## Strong values, dynamic thinking

Over the years we have seen the world change. Technological, social and cultural innovations, together with climate change, are transforming our lives and the way we inhabit our spaces. The office, the home, public and private spaces are now hybrid environments that demand new design approaches.

In response to these ongoing changes the Quadrifoglio Group has made a pledge: to make design sustainable in order to improve our quality of life. A sense of ethics that pervades all of its actions. From the careful selection of top-quality raw materials through to the expert choice of the most evocative finishes, from the manual actions of its designers, who sketch out their initial ideas on a piece of paper, through to those of the machinery which sculpts it from the material with pinpoint precision.

**Quadrifoglio Group, since 1991.**

---

## La nostra Identità

### Valori fermi, pensiero dinamico

Nel corso degli anni, abbiamo visto cambiare il mondo. Le innovazioni tecnologiche, sociali e culturali e i cambiamenti climatici stanno trasformando la nostra vita e il modo in cui abitiamo gli spazi. L'ufficio, la casa, i luoghi pubblici e privati sono ormai ibridi e impongono nuove vie di pensiero alla progettazione.

In Quadrifoglio Group interpretiamo questi incessanti mutamenti attraverso un unico impegno: rendere sostenibile il design, per aumentare la qualità della vita. Un rigore etico che pervade ogni gesto. Dalla selezione accurata delle materie prime di assoluta qualità, fino alla scelta sapiente delle finiture più evocative, dal movimento delle mani dei designer, che tracciano su un foglio la prima manifestazione di un'idea, fino a quello del macchinario che con accuratezza millimetrica la scolpisce nella materia.

**Quadrifoglio Group, dal 1991.**







# People and relations

## Thoughts, ideas, intuition

There would be no places without the people that live there. There would be no design without ideas. There would be no Quadrifoglio Group without our workers, customers and partners.

At the Quadrifoglio Group every project stems from and for interpersonal relations; from the sharing of an idea by designers to the production of ergonomic furniture and through to the design of comfortable spaces perfect for personal interaction. We choose our partners on the basis of shared values. We share with all employees a style of work based on order, both exterior and interior. During the year we dedicate time to training in order to share knowledge and enrich our perspective. Social commitment, company welfare and the protection of personal safety: this is how we put our people at the centre.

Quadrifoglio Group, people first and foremost.

---

## Persone e relazioni

### Pensieri, idee, intuizioni

Non esisterebbero i luoghi senza le persone che li vivono. Non esisterebbe il design senza un'intuizione tra le mani. Non esisteremmo noi, senza i nostri collaboratori, clienti e partner.

In Quadrifoglio Group ogni progetto nasce dall'incontro e per l'incontro tra le persone. Da quando un'idea viene condivisa dai designer, alla produzione di arredi ergonomici, fino alla progettazione di ambienti confortevoli, dove abitare le relazioni. Selezioniamo i nostri partner sulla base di valori comuni. Condividiamo uno stile di lavoro improntato all'ordine, esteriore e interiore, con tutti i dipendenti. Dedichiamo del tempo durante tutto l'anno alla formazione, per contaminare i saperi e arricchire la nostra prospettiva. Impegno sociale, welfare aziendale e tutela della sicurezza: ecco come mettiamo le persone al centro.

Quadrifoglio Group, siamo prima di tutto persone.



# Our commitment

## Sustainability is an everyday action

Sustainability is awareness, vision, transformation. It is the ability to construct the future by taking action in the present, also by changing little things.

At the Quadrifoglio Group we work every day to ensure that Sustainability becomes pervasive: a way of thinking, working and living, to feel good today and even better tomorrow. An ethical value, to share collectively but also to practice individually. Our focus on improving company processes, with respect for the environment, is constant. From the streamlining of production to the attainment of international green certificates, from company welfare policies through to the creation of an open roundtable with our team dedicated to sustainability, in order to share goals and strategies. This is our commitment.

Quadrifoglio Group, informed ethics.

---

## Il nostro impegno

### La Sostenibilità è un atto quotidiano

La Sostenibilità è consapevolezza, visione, trasformazione. È la capacità di costruire il futuro agendo nel presente, anche attraverso piccoli gesti.

In Quadrifoglio Group ci impegniamo ogni giorno affinché la Sostenibilità diventi pervasiva: un modo di pensare, di lavorare e di vivere, per stare bene oggi e meglio domani. Un valore etico, da condividere collettivamente e da praticare anche individualmente. La nostra tensione verso il miglioramento dei processi aziendali, nel rispetto dell'ambiente, è costante. Dalla razionalizzazione della produzione, all'ottenimento delle certificazioni green internazionali, dalle politiche di welfare aziendale, fino alla creazione di un tavolo aperto con il nostro team dedicato alla sostenibilità, per condividere obiettivi e strategie. Questo è il nostro impegno.

Quadrifoglio Group, etica consapevole.



The mark of responsible forestry

Look for our FSC™-certified products







# Klavertje vier, Trèfle à quatre feuilles, Four-leaf clover, четырёхлистный клевер

## An international empathy

In all languages and cultures, Made in Italy is synonymous with quality raw materials, attention to detail and elegance. We export our exclusive and universally-recognised approach and method to Europe and the rest of the world.

At the Quadrifoglio Group Made in Italy means being in touch with the needs of the present: familiarity with different cultures, understanding people's needs and designing solutions tailored to future habits. We speak the language of the foreign markets through an international style and, thanks to our sales and marketing departments, we communicate with our customers in their own languages because making people feel part of a family is the absolute epitome of care and professionalism in our opinion.

Quadrifoglio Group, Italy. World.

---

# Klavertje vier, Trèfle à quatre feuilles, Four-leaf clover, четырёхлистный клевер

## Un'empatia internazionale

In tutte le lingue e le culture, Made in Italy è sinonimo di qualità delle materie prime, attenzione ai dettagli ed eleganza. Esportiamo in Europa e in tutto il mondo un modo di essere e di fare esclusivo, riconosciuto universalmente.

VIII

In Quadrifoglio Group Made in Italy significa essere in ascolto delle necessità del presente: conoscere diverse culture, comprendere le esigenze delle persone e disegnare soluzioni a misura delle abitudini che verranno. Parliamo il linguaggio dei mercati esteri attraverso uno stile internazionale e, grazie ai nostri dipartimenti, commerciale e marketing, comunichiamo con i clienti nelle loro lingue madri, perché far sentire le persone come in famiglia per noi è la massima espressione di cura e professionalità.

Quadrifoglio Group, Italia. Mondo.



# Index

02-261

## DESIGN CHAIRS & SOFT SEATING

MOON / CITY / CITY DÉCO / COMPASSO / CODE / COVE / CLUE / CELSIUS / CLARK / C-STOOL / CELL / CLOSE /  
CLEOPAS / CITY LOUNGE / CITY DÉCO LOUNGE / AVANA / ARCO / ARTE / ACCORD /  
ABBAY / ADO / ASTRO / ARMONY / AGIO / ALIAS

---

262-345

## ACCESSORIES & SIDE TABLES

MONTREAL / MIAMI / MELBOURNE / COZY / T01 / T02 / T03 / T05 / T06 /  
FLIPPER / PETAL & CLOAK / ALTER EGO

---

346-401

## LIVING TABLES

NINE / EIGHT / SEVEN / SIX / FIVE / THREE / TWO / CREO & GREKO

---

402-445

## STORAGE & PARTITIONING

BLOOM / ZEFIRO / LIBRERIA / BOISERIE / P1 BOISERIE / M3

---



## Design Chairs Index

---



MOON

04 | 19



CITY

20 | 31



CITY DÉCO

32 | 37



COMPASSO

38 | 47



CODE

48 | 59



COVE

60 | 71



CLUE

72 | 81



CELSIUS

82 | 89



CLARK

90 | 97



C-STOOL

98 | 103



CELL

104 | 113



CLOSE

114 | 123

## Soft Seating Index

---



CLEOPAS

124 | 137



CITY  
LOUNGE

138 | 151



CITY DÉCO  
LOUNGE

152 | 157

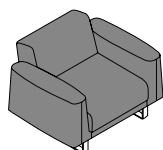

AVANA

158 | 171

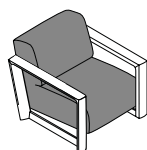

ARCO

172 | 181

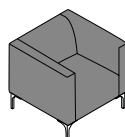

ARTE

182 | 191

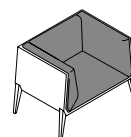

ACCORD

192 | 203

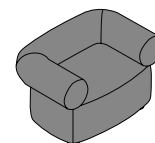

ABBEY

204 | 213

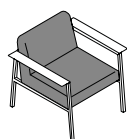

ADO

214 | 225



ASTRO

226 | 237

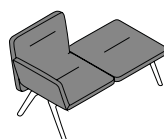

ARMONY

238 | 247



AGIO

248 | 255

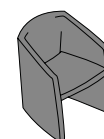

ALIAS

256 | 261



designed by Serena Papait

**Copernican revolution.  
Moon redesigns the  
concept of ergonomics:  
a unique and continuous  
structure that moulds  
the body into a more  
natural posture.**

**Rivoluzione copernicana.  
Moon riscrive il concetto di ergonomia: una  
struttura unica e continua che plasma il corpo in  
una postura più naturale.**



MOON design chair | White polypropylene shell and E01/421 fabric upholstered soft pads  
FLIPPER home office table | White frame and top

Residential & Hospitality Collection





**From pencil to space: Moon is the result of research on paper which culminates in a unique piece, designed to adapt to people of all ages.**

Dalla matita allo spazio: Moon è frutto di una ricerca condotta su carta, che trova compimento nel design di un pezzo unico, progettato per adattarsi a persone di tutte le età.



MOON design chair | Umbra Grey polypropylene shell and E01/431 fabric upholstered soft pads

Residential & Hospitality Collection





**In Moon, the colours of the shell and soft pads are customisable to suite tastes and settings. The seat becomes a furnishing piece for the home office and other professional settings.**

I colori della scocca e dei cuscinetti di Moon sono personalizzabili a seconda dei gusti e del contesto di destinazione. La seduta diventa un oggetto d'arredo per l'home office e altri ambienti professionali.



MOON design chair | Umbra Grey polypropylene shell and E01/431 fabric upholstered soft pads  
P1 BOISERIE | Whitened Elm panels and shelves, Umbra Grey tracks  
FIVE table | Umbra Grey legs and Whitened Elm top





**The neoprene soft pads are non-deformable and boost comfort, acting as decompression points. They are covered in fabric and available in different colours, including vibrant tonalities that match the shell, or elegant hues according to taste preferences.**

I cuscini in neoprene sono indeformabili e aumentano il comfort, diventando dei punti di decompressione. Sono rivestiti in tessuto, disponibile in diverse tonalità, per creare abbinamenti con la scocca vivaci o eleganti in base ai propri gusti.



**MOON** design chair | Olive Green polypropylene shell and E01/417 fabric upholstered soft pads  
**HALF MOON** table lamp | Black fabric shade and Black base





**The seat is designed to distribute the weight on the knees in particular, without weighing down the spine.**

**This is also possible thanks to a perpetual oscillation movement of the body, induced by sitting.**

La seduta è concepita per distribuire il peso in particolare sulle ginocchia, senza andare ad appesantire la colonna vertebrale. Questo è possibile anche grazie a un movimento perpetuo di oscillazione del corpo, indotto dalla seduta.







**Elegance, presence and dynamism: Moon is not only a seat designed in the name of ergonomics and postural well-being, but it's also a piece of furniture with a refined design.**

Eleganza, presenza e dinamicità: Moon non è solo una seduta progettata all'insegna dell'ergonomia e del benessere posturale, ma è anche un oggetto d'arredo dal design ricercato.





MOON design chair | White polypropylene shell and E01/429 fabric upholstered soft pads  
LIBRERIA bookshelves | Ocean Blue lacquer  
X1 desk | White legs and top



designed by Edi & Paolo Ciani

**Balanced design.  
When aesthetics and  
comfort meet, it brings  
City to life: harmonious  
shapes and finishings,  
for a versatile and  
ergonomic seat.**

**Equilibri di design.  
Quando estetica e comfort si incontrano,  
nasce City: forme e finiture in armonia, per  
una seduta versatile ed ergonomica.**









CITY design chair | P01/095 leather and Umbra Grey frame  
NINE table | Ebony top and Umbra Grey legs  
BLONDE pendant lamp | Gold

Residential & Hospitality Collection



**Every single detail of City is meticulously pondered: double stitching, different upholstery densities, back inclinations, streamlined thicknesses and soft bossing. All this so that the seat can be enjoyed in superlative comfort.**

Ogni particolare di City è curato: cuciture con doppia battitura, densità diverse dell'imbottitura, inclinazione dello schienale, spessori sottili e bombature morbide. Tutto per godersi la seduta con la massima comodità.





CITY design chair | D02/272 fabric and Chrome frame  
CITY design chair | B03/180 simil leather and Chrome frame  
T45 desk | Elm top and frame









CITY design chair | E03/467 fabric and Oak varnished solid ash wood legs  
THREE table | Umbra Grey lacquer top, Oak and Umbra Grey legs



**City is suitable for all settings and styles, thanks to the vast assortment of finishes and frames. The version with four wooden legs is a timeless classic, evoking natural elements and a nordic ambience.**

City è adatta ad ogni ambiente e stile grazie alla vasta disponibilità di rivestimenti e basamenti. La versione con quattro gambe in legno è un classico intramontabile, che evoca elementi naturali e atmosfere nordiche.





# CITY DÉCO

designed by Edi & Paolo Ciani

**Bohémian spirit.  
City Déco is a variant of the  
collection City. Welcoming  
and elegant, thanks to  
a particular artisanal  
technique, a rich and draped  
effect is created on the seat.**

**Spirito bohémien.**

**City Déco è una variante della collezione City.  
Accogliente ed elegante, grazie ad una  
particolare lavorazione del tessuto viene creato  
un effetto ricco e drappeggiato sulla seduta.**





**The special finish and artisan stitching of the fabric create a drapery effect, enriching the seat with an original and alluring appearance, matched with wood or metal legs.**

La lavorazione particolare e la cucitura artigianale del tessuto creano un effetto drappeggiato, che conferisce alla seduta un aspetto ricercato e seducente, con la complicità delle gambe in legno o in metallo.





CITY DÉCO design chair | I01/516 fabric and Bronze frame  
SIX table | Noir Desir porcelain stoneware top and Bronze frame





# COMPASSO

designed by Dorigo Design

**Artistic geometries.  
Compasso is an ash wood  
sculpture that exudes  
originality and refinement  
in both its design and build,  
matched with a pureness  
laden with meaning.**

**Geometrie d'arte.  
Compasso è una scultura in legno di frassino, ricercata  
e sofisticata dalla progettazione alla realizzazione,  
con una purezza ricca di significato.**









COMPASSO design chair | Umbra Grey varnished solid ash wood frame and B03/185 simil leather seat  
T06 round table | Eucalyptus top and Umbra Grey frame  
FIVE table | Eucalyptus top and Umbra Grey frame



**The name is inspired by the angle formed by the cantilevered joint on the rear of the back. The legs are triangular on the lower part and square on the upper part, which adds an original touch to all interiors.**

**Il nome deriva dall'angolo formato dal raccordo a sbalzo sul retro dello schienale. Le gambe sono triangolari nella parte inferiore e quadrate in quella superiore, per conferire un tocco ricercato ad ogni ambiente.**



COMPASSO design chair | Oak varnished solid ash wood frame and Umbra Grey varnished solid ash wood seat and back  
COZY coffee table | Oak top and Umbra Grey frame





**The variable section plywood back and seat are available in different finishings: oak ash, walnut, umbra grey and white. The seat can also be upholstered and covered with many kinds of fabric options for different interiors.**

Lo schienale è in legno multistrato a sezione variabile e il sedile è stato pensato in svariate finiture: frassino tinta rovere, noce, grigio ombra e bianco. Il sedile si può imbottire e rivestire con numerosi tipi di tessuti per arredare diversi tipi di spazi.





COMPASSO design chair | Walnut varnished solid ash wood frame and D03/363 fabric seat  
FIVE table | Canaletto Walnut top and Umbra Grey frame  
BLOOM credenza | Nero Greco porcelain stoneware and Umbra Grey legs  
ADD pendant lamp | Matt clay shade



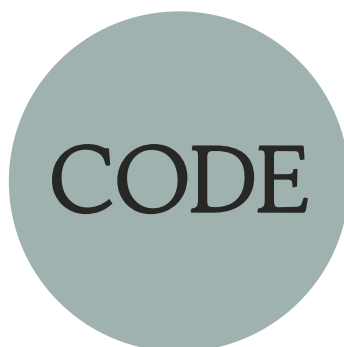

designed by Dorigo Design

**Cutting-edge comfort.  
Technique and  
ergonomics go hand  
in hand in the shape of  
Code, bringing to life a  
mindful and gracefully  
inviting seat.**

**Comfort d'avanguardia.  
Tecnica ed ergonomia si intrecciano nelle  
forme di Code, per dare vita a una seduta  
sapiente che accoglie con garbo.**



**CODE** design chair | Walnut varnished solid ash wood legs and shell, C05/280 fabric seat  
**SIX** table | Umbra Grey frame and Invisible White porcelain stoneware top  
**AFRA** pendant lamp | Matt White acid-etched glass shade  
**BLOOM** credenza | American Walnut doors and sides, Invisible White porcelain stoneware top and Umbra Grey legs





**The stool version, with  
lacquered beech plywood or  
natural painted veneered ash or  
walnut, is slender, practical and  
functional, perfect for shared  
and reception interiors.**

La versione sgabello, con scocca laccata in multistrato di faggio o impiallacciata frassino verniciato naturale o noce, è slanciata, pratica e funzionale, perfetta per gli spazi della collettività e dell'ospitalità.







**The alluring lines of Code unveil a classic and timeless side, reinterpreted with back and seat cuts and folds inspired by the shapes of the female body.**

Le ammalianti linee di Code celano un lato classico senza tempo, rivisitato con tagli e piegature dello schienale e della seduta che si ispirano alle forme del corpo femminile.



**Thanks to numerous available finishings, Code is the ideal seat for furnishing multifunctional interiors, with a sinuous style and eccentric touch. Comfort is guaranteed, to be appreciated day after day.**

Grazie alle numerose finiture a disposizione, Code è la sedia ideale per arredare ambienti polifunzionali con uno stile sinuoso e un tocco eccentrico. Una garanzia di comodità da apprezzare giorno dopo giorno.



CODE design chair | Umbra Grey lacquered and Oak varnished solid ash wood shell, Chrome legs  
T02 coffee table | Oak top and Umbra Grey frame

DESIGN LIVING







CODE design chair | Walnut varnished solid ash wood shell and legs  
CODE high stool | Walnut varnished solid ash wood shell and Chrome legs  
SEVEN table | Canaletto Walnut top and Bronze frame  
STARLIGHT GIANT wall lamp | Bronze



designed by Dorigo Design

**Transversal identity.  
The heart and soul of the  
collection, Cove is sinuous  
and enveloping, but also  
pure and linear at the same  
time: a single concept, in  
manifold expressions.**

**Identità trasversale.  
L'anima della collezione Cove è sinuosa e  
avvolgente, ma allo stesso tempo pura e lineare:  
un unico concetto, tante declinazioni.**











COVE outdoor chair | White frame and D06/507 simil leather upholstered seat  
COZY coffee table | White frame and top  
ACCORD sofa | E03/467 fabric and D06/507 simil leather, Umbra Grey frame



**The stool version of Cove is specially designed for hospitality and conviviality. The seat features an upholstered or polypropylene shell; it is comfortable, sturdy and functional, also thanks to the swivel base that is adjustable in height.**

La versione sgabello di Cove è dedicata all'ospitalità e alla convivialità. La seduta, con scocca imbottita o in polipropilene, è confortevole, solida e funzionale, grazie anche al basamento girevole regolabile in altezza.



COVE high stool | P01/172 leather and Chrome frame  
BOISERIE | White back, Matt White glass shelves and Umbra Grey uprights  
TUBE pendant lamp | Black

DESIGN-LEWING



COVE design chair | D02/268 and D02/277 fabric, Umbra Grey varnished solid ash wood legs  
COZY coffee table | Beige lacquered top and Umbra Grey varnished solid ash wood legs  
PETAL acoustic panels | B01/009 fabric  
CD LED pendant and table lamp | Black

Residential & Hospitality Collection





COVE design chair | D02/278 fabric and Umbra Grey frame  
P1 wall cladding | Oak panels and Umbra Grey tracks

Residential & Hospitality Collection





**The essential design of the sled model bestows a sober and elegant character upon this Cove seat. Ideal for refined and formal settings, it provides comfort for all users.**

Il design essenziale del modello slitta conferisce a questa seduta Cove un carattere sobrio ed elegante. Ideale per contesti dall'aria raffinata e formale, è pensata per accogliere al meglio ogni persona.





designed by Dorigo Design

**Precious simplicity.  
Clue is defined by clear-cut  
and graceful lines, which  
take centre stage in all  
kinds of interiors, in virtue  
of their silent beauty.**

**Preziosa semplicità.  
Clue è definita da linee nette e cortesi, che  
diventano protagoniste in ogni tipologia di  
ambiente per la loro silente bellezza.**



CLUE design chair | White polypropylene shell and D02/270 fabric upholstered seat, Walnut varnished solid ash wood legs  
TWO table | Canaletto Walnut top and White frame  
SUN pendant lamp | White fabric shade





**Space becomes a stage just waiting to be filled with colourful fabrics and slender legs: the seat is available with ergonomic upholstery or in polypropylene. Manual flair, clear-cut lines and superlative comfort: this is Clue.**

Lo spazio diventa un palcoscenico da riempire con tessuti colorati e gambe slanciate: la seduta è disponibile con imbottitura ergonomica o in polipropilene. Estro manuale, linee nette e comfort totale: questa è Clue.

CLUE design chair | D04/398 fabric and Bronze frame  
EIGHT table | Eucalyptus top and Bronze frame  
BABEL pendant lamp | Black shade

Residential & Hospitality Collection







**CLUE** design chair | P01/095 leather and Oak varnished solid ash wood legs  
**NINE** table | American Walnut top and Umbra Grey frame  
**OLA** pendant lamp | White fibreglass shade  
**MIAMI** metal pot | Bronze











designed by Quadrifoglio Group

**Levels of interpretation.  
Celsius has an eternal  
soul with a spontaneous  
shape, expressed in a  
multitude of versions,  
colours and finishings.**

**Gradi di interpretazione.  
Celsius ha un animo eterno dalla forma  
spontanea, che si esprime in una pluralità di  
versioni, colori e finiture.**











**Celsius is available in the chair and high stool version, ideal for a kitchen, canteen or catering area. The beech plywood shell is solid and rigorous.**

Celsius è disponibile in versione sedia e sgabello alto, ideale per una cucina, per una mensa o per uno spazio di ristorazione. La scocca è in legno di faggio multistrato, solida e rigorosa.





**Celsius is available in different versions to meet a variety of needs: upholstered and covered, or with the shell in full view and the back embellished by a geometric cut.**

È possibile scegliere tra differenti declinazioni di Celsius, a seconda delle proprie esigenze: con imbottitura e rivestimento, oppure con la scocca a vista e lo schienale impreziosito con un taglio geometrico.



CELSIUS chair | Umbra Grey lacquered shell and Chrome legs  
X8 meeting table | Canaletto Walnut top and Umbra Grey frame  
BLONDE pendant lamp | Black



designed by Edi & Paolo Ciani

**Contemporary conviviality.  
Clark is the ideal stool for  
residential, hospitality and  
catering interiors: modern,  
playful and eclectic.**

**Convivialità contemporanea.  
Clark è lo sgabello ideale sia per ambienti  
residenziali che per spazi di ospitalità e  
ristorazione: moderno, giocoso ed eclettico.**







CLARK high stool | Umbra Grey varnished solid ash wood seat and Umbra Grey frame  
T02 high table | Eucalyptus top and Umbra Grey frame



**The seat is made up of numerous wooden slats, placed side by side and interspersed with thin slits: a solution that gives stability to the stool and makes the aesthetics dynamic.**

Il sedile è composto da numerose doghe in legno, poste una accanto all'altra e intervallate da sottili fessure: una soluzione che dona stabilità allo sgabello e rende dinamica l'estetica.







**CLARK** high stool | Oak varnished solid ash wood seat and Matt White frame  
**ADD** pendant lamp | Bronze and White shade



**The steel rebar structure and wooden seat create a contrast suitable for rustic, industrial and modern interiors with an understated style: a versatile furnishing piece for residential and contract projects.**

La struttura in tondino di acciaio e la seduta in legno creano un contrasto adatto ad ambienti rustici, industriali e moderni dallo stile sobrio: un oggetto d'arredo versatile per la casa e per progetti contract.



# C-STOOL

designed by Atelier Studio Borella

**Personal inclination.  
C-Stool is the perfect  
seat for home and  
professional settings:  
thanks to its light  
inclination, it provides  
dynamic comfort and an  
active posture.**

**Inclinazione personale.  
C-Stool è la seduta perfetta per la casa e per ambienti  
professionali: grazie alla sua leggera pendenza, regala un  
comfort dinamico e una postura attiva.**











**Geometric yet soft, C-Stool  
is available in customisable  
colours and finishings, to  
match the style of interiors and  
engage in dialogue with other  
furnishing accessories.**

Geometrico e morbido allo stesso tempo, C-Stool  
è personalizzabile nei colori e nelle finiture, per  
assecondare lo stile dello spazio e dialogare con  
gli altri complementi d'arredo.



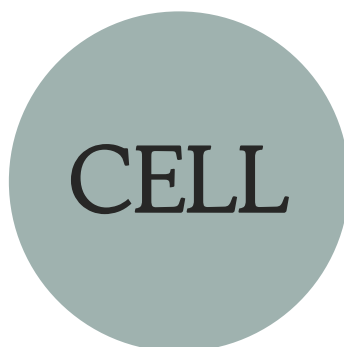

designed by Martin Ballendat

**Practicality in 3D.  
Cell combines tradition  
and technology: a  
metal structure with a  
comfortable back and  
seat, elaborated thanks  
to the 3D technique.**

**Praticità in 3D.  
Cell coniuga tradizione e tecnologia:  
una struttura in metallo con schienale  
e seduta confortevoli, elaborati grazie  
alla tecnica 3D.**





CELL chair | Black polypropylene seat and back, Chrome frame  
FIVE table | Eucalyptus top and Umbra Grey frame  
BLONDE pendant lamp | Black



**Cell is ecosustainable as it is made of recycled materials, from the metal structure to the back and seat, all modelled by 3D design. It is customisable in different colours to enhance interior design projects.**

Cell è ecosostenibile: i materiali di cui è composta sono riciclati, dalla struttura in metallo, fino allo schienale e al sedile, modellati dal design 3D. È personalizzabile in diversi colori, per valorizzare progetti di interior design.











CELL chair | Blue, Ocher and White  
THREE table | Oak top and White frame  
CLOAK acoustic panels | B01/012, B01/014 and B01/026 fabric



CELL chair | Blue, Ocher and White  
THREE table | Oak top and White frame



**Cell is a stackable seat, with armrests designed to also lean against the table top. It is ideal for restaurants, canteens, lounge and relaxation areas: distinctive personality and superlative originality.**

Cell è una seduta impilabile, con braccioli studiati per essere appoggiati anche al piano di un tavolo. È ideale per ristoranti, mense, aree lounge e zone relax: forte personalità, grande originalità.



designed by Scagnellato & Ferrarese

**Sitting, together.  
Close is a seat featuring  
simple lines, available in  
numerous finishings and  
ideal for conference halls,  
classrooms, waiting areas  
and cafeterias.**

**Sedersi, insieme.**

**Close è una seduta dalle linee semplici,  
disponibile in numerose finiture e ideale per sale  
conferenze, aule, aree d'attesa e caffetterie.**











**Close is stackable, easy to handle thanks to its lightweight yet robust structure, and available in customisable compositions: stool, bench or single seat with or without a removable writing tablet. Perfect for creating convivial settings of different sizes.**

Close è impilabile, facilmente maneggiabile grazie alla sua struttura leggera ma solida, e personalizzabile nella composizione: sgabello, panca, o seduta singola con o senza scrittoio d'appoggio removibile. Perfetta per creare ambienti conviviali di diversa metratura.

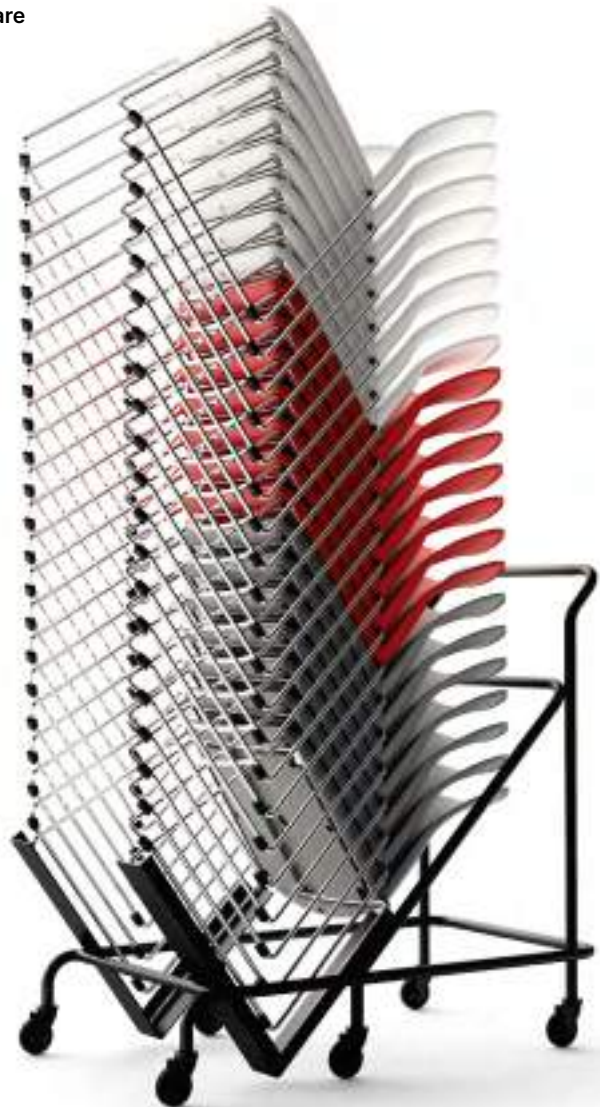



**CLOSE** chair | White polypropylene shell with M02/584 and M02/569 fabric seat, White frame  
**X3** bench desk | Oak top, White and Oak legs  
**LIBRERIA** bookshelves | Olive Green lacquer





**The inner surface of the backrest features a striped pattern, adding a dynamic effect to the seat. This original detail makes Close suitable for different interior design styles.**

La superficie interna dello schienale è lavorata con un motivo rigato per donare dinamismo alla seduta. Questa sua particolarità inedita rende Close adatta a diversi stili di interior design.

CLOSE high stool | White polypropylene shell with M02/584 and M02/569 fabric seat, Chrome frame  
CREO high table | Oak top and White legs  
LIBRERIA bookshelves | Olive Green lacquer





# CLEOPAS

designed by Trevor Hollard & Brado

**Regal comfort.  
A majestic and  
ergonomic seat, with an  
enveloping backrest and  
soft upholstery: Cleopas  
is the queen of comfort.**

**Comodità regale.  
Una struttura maestosa ed ergonomica,  
uno schienale avvolgente e un'imbottitura  
soffice: Cleopas è la regina del comfort.**













CLEOPAS armchair | Umbra Grey shell and M03/600 fabric, Umbra Grey base  
CARTESIO ceiling track with Queen lights | Black  
ABBEY pouf | M03/600 fabric







**The shell can be customised to create contrasts between vibrant tones or single-colour compositions. Cleopas is also available with a painted backrest featuring a decorative grill pattern. The seat can be completed with a side table.**

La scocca è personalizzabile per creare contrasti tra colori vivaci o composizioni monocrome. Cleopas è disponibile anche con lo schienale verniciato e lavorato con motivo decorativo a griglia. La seduta si può completare con tavolino d'appoggio.



CLEOPAS armchair | Umbra Grey shell and M03/600 fabric, Umbra Grey base  
ABBEY pouf | M03/600 fabric  
CD LED floor lamp | Black

DESIGN LIVING



CLEOPAS armchair and ottoman | E03/463 fabric and Umbra Grey base  
MIAMI side table | Fokos Terra porcelain stoneware top and Umbra Grey base  
OLA floor lamp | White fibreglass shade and Black base







**The upholstery is designed to be elastic and non-deformable: Cleopas provides superlative comfort in the home, hotel, or other relaxing interiors. It can be matched with an ottoman, for an elegant and comfortable pairing.**

L'imbottitura è studiata per essere elastica e indeformabile: Cleopas regala così un comfort superiore in casa, in hotel e in altri ambienti di relax. Si può accompagnare a un poggiatesta in una combinazione elegante e confortevole.



CLEOPAS armchair | White shell, D03/367 and D03/368 fabric, White base  
MONTREAL side table | Olive Green lacquered top and Umbra Grey frame

DESIGN LIVING





designed by Edi & Paolo Ciani

**Urban charm.  
City Lounge is a range of  
soft seats that naturally  
take centre stage in any  
relaxing interior and  
waiting room.**

**Charme urbano.  
City Lounge è una famiglia di sedute soft,  
protagoniste naturali di ogni ambiente di relax  
e delle sale d'attesa.**



CITY LOUNGE armchair | P01/095 leather and Black frame  
MIAMI side tables | Noir Desir porcelain stoneware top and Umbra Grey frame  
GRACE floor lamp | Natural linen shade and Black base  
CITY DÉCO LOUNGE armchair | E04/490 fabric and Bronze frame





CITY LOUNGE armchair | D05/413 fabric and Oak varnished solid ash wood legs  
MELBOURNE side table | Fokos Terra porcelain stoneware top and Oak varnished solid ash wood legs





CITY LOUNGE armchair | P01/096 leather and C05/280 fabric, Black base  
MONTREAL side tables | Fokos Terra and Fokos Piombo porcelain stoneware top, Umbra Grey base  
HALF MOON floor lamp | Black fabric shade and Black base

Residential & Hospitality Collection



**The design of City Lounge is curated down to the finest of details, from precious finishings to upholstery, for overall harmony. Elegant and sinuous, the seat is suitable both for contract and living interiors.**

Il design di City Lounge è curato nel dettaglio, dalle finiture preziose, all'imbottitura, fino all'armonia d'insieme. Elegante e sinuosa, la seduta è adatta sia per spazi contract che per ambienti living.



CITY LOUNGE armchair | P01/096 leather and C05/280 fabric, Black base  
MONTREAL side table | Fokos Terra and Fokos Piombo porcelain stoneware top, Umbra Grey base  
HALF MOON floor lamp | Black fabric shade and Black base





**The City Lounge line is available in a tall version, with or without a headrest, and a low version, with swivel base, four regular or tubular legs, in wood or metal. The seat can also be fitted with a matching ottoman.**

La linea City Lounge è disponibile in versione alta, con o senza poggiatesta, e bassa, con basamento girevole, con le quattro gambe o con quelle tubolari, in legno o metallo. La seduta può essere anche dotata di poggia piedi coordinato.







150

CITY LOUNGE armchair | B03/185 simil leather and Black base  
MELBOURNE side table | Umbra Grey lacquered top and Oak varnished solid ash wood legs







**CITY DÉCO**  
LOUNGE

designed by Edi & Paolo Ciani

**Decorative refinement.  
City Lounge Déco is  
a version of the City  
Lounge collection with a  
bohèmien style, ideal for  
vintage style residential  
and contract interiors.**

**Raffinatezza decorativa.**

**City Lounge Déco è una variante della collezione City  
Lounge dallo stile bohèmien, ideale per ambienti dallo  
stile retrò, sia residenziali che contract.**







CITY DÉCO LOUNGE armchair | E04/476 fabric and Bronze frame  
MELBOURNE side table | Fokos Terra top and Oak varnished solid ash wood legs  
MELBOURNE pouf | E03/464 fabric and Oak varnished solid ash wood legs  
GRACE floor lamp | Natural Linen shade and Black base







designed by Dorigo Design

**An archipelago of design.  
Ideal for business, home  
and hotel interiors, Avana  
is a collection of modular  
and customisable seats,  
for unique furnishing,  
every single time.**

**Arcipelago di design.  
Ideale per ambienti business, case e hotel,  
Avana è una collezione di sedute componibili  
e personalizzabili, per progettare ogni volta  
un arredo unico.**





AVANA composable sofa | E03/464 fabric, Canaletto Walnut table top and Umbra Grey legs  
MIAMI side table | Umbra Grey lacquered top and Umbra Grey frame  
MIAMI metal pot | Umbra Grey frame

Residential & Hospitality Collection







**AVANA** sofa and pouf | E04/490 fabric and Umbra Grey legs  
**GRACE** floor lamp | Natural Linen shade and Black base  
**MIAMI** side table | Emperador Lucido porcelain stoneware top and Umbra Grey frame





AVANA composable sofa | M01/556 fabric, Eucalyptus table top and Umbra Grey legs  
MIAMI side table | Fokos Terra porcelain stoneware top and Umbra Grey frame  
GRACE floor lamp | Natural Linen shade and Black base  
STARLIGHT GIANT wall lamp | Gold



DESIGN LIVING

AVANA composable sofa | D04/387 fabric and Umbra Grey legs  
MIAMI side table and pouf | Emperador Lucido porcelain stoneware top, E04/486 fabric and Bronze frame  
HALF MOON floor lamp | Black fabric shade and Black base

Residential & Hospitality Collection







**Avana is a universe of comfort and practicality: the collection is enriched by accessories including coffee tables, swivel tables and USB sockets. An extensive selection of colours and finishings adds character to any interior.**

Avana è un universo di comfort e praticità: la collezione è accessoriata con tavolini rotanti, piani d'appoggio e prese USB. Per conferire carattere a ogni ambiente, è possibile scegliere tra numerosi colori e finiture.

AVANA composable sofa | I02/535 fabric and Umbra Grey legs  
MONTREAL side table | Fokos Piombo porcelain stoneware top and Umbra Grey frame  
CLARK high stool | Oak varnished solid ash wood seat and Umbra Grey frame  
CARTESIO ceiling track with Queen lights | Black





AVANA composable sofa | E02/438 fabric, Oak top and Umbra Grey legs  
MELBOURNE side table | Umbra Grey lacquered and Fokos Piombo porcelain stoneware tops, Oak legs  
CLEOPAS armchair | E03/463 fabric and Umbra Grey base

Residential & Hospitality Collection







designed by Dorigo Design

**Classic archetype.  
The armchair and sofa  
from the Arco range  
reinterpret the canons of  
nordic design and are ideal  
for convivial settings.**

**Archetipo classico.  
La poltrona e il divano della linea Arco sono  
una rivisitazione dei canoni del design  
nordico, ideali per luoghi conviviali.**



ARCO sofa and armchair | Walnut varnished solid ash wood frame, M01/554 and M01/556 fabric  
T05 coffee table | Umbra Grey lacquer  
GRACE floor lamp | Natural Linen shade and Black frame  
MIAMI side table | Noir Desir porcelain stoneware top and Umbra Grey frame









**The extensive range of materials and finishes enhances the authoritative and rigorous aesthetics of the Arco collection, suitable for contract and home interiors alike, as well as professional firms, waiting areas, lounges and other business settings.**

L'ampia gamma di materiali e finiture valorizza l'estetica imponente e rigorosa della collezione Arco, adatta sia per ambienti residenziali che per spazi contract ma anche per studi professionali, aree d'attesa e lounge e altri luoghi aziendali.





**ARCO** armchair | Walnut varnished solid ash wood frame and I01/519 fabric  
**MIAMI** side table | Invisible White porcelain stoneware top and Umbra Grey frame  
**GRACE** floor lamp | Natural Linen shade and Black frame







ARCO armchair | Oak varnished solid ash wood frame and E02/446 fabric  
MELBOURNE side table | Umbra Grey lacquered top and Oak varnished solid ash wood legs  
STARLIGHT GIANT wall lamp | Bronze



**The perfect geometry of the square is softened by the delicate upholstery adapted to the continued shape of the legs, which also act as an armrest and confer a square yet inviting volume upon the line.**

La geometria perfetta del quadrato viene addolcita dalla morbida imbottitura e addomesticata nella forma continua delle gambe, che fungono anche da bracciolo e conferiscono alla linea un volume squadrato e al contempo accogliente.





designed by Quadrifoglio Group

**Untamed masterpiece.  
The art of design is all  
about combining beauty  
and well-being, which is  
masterfully spearheaded  
by accessories from the  
Arte line.**

**Capolavoro indomito.  
L'arte del design è quella di unire bellezza e  
benessere: un traguardo raggiunto egregiamente  
dai complementi della linea Arte.**





ARTE sofa | I01/519 fabric and Chrome legs  
CITY DÉCO LOUNGE armchair | E04/487 fabric and Gold frame  
MELBOURNE side table | Invisible White and Nero Greco porcelain stoneware tops, Oak varnished solid ash wood legs  
AFRA floor lamp | Matt White acid-etched glass shade



ARTE sofa | E04/480 fabric and Chrome legs  
MONTREAL side table | Invisible White and Fokos Piombo porcelain stoneware tops, Umbra Grey frame  
Z1 reception desk | Grey White and Beige lacquers  
CARTESIO ceiling track with Bond, Spotlight, Queen and Globe lights | Black







**The enveloping backrest and high armrests encourage the correct and composed posture of guests and clients in waiting rooms, halls, ateliers and other interiors designed to provide a pleasant reception experience.**

Lo schienale avvolgente e i braccioli alti favoriscono una postura corretta e composta di ospiti e clienti in sale d'attesa, hall, atelier e altri ambienti dedicati a una garbata accoglienza.



ARTE sofa | D04/384 fabric and Chrome legs  
AGIO armchair | E04/475 fabric and Chrome frame  
OLA floor lamp | White fibreglass shade and Black base  
MONTREAL side table | Noir Desir porcelain stoneware and Silk Grey lacquered tops, Bronze frame

Residential & Hospitality Collection









# ACCORD

designed by Dorigo Design

---

**Rational design.  
Accord is the range of  
armchairs and sofas  
designed for hospitality  
interiors, thanks to its  
inviting aesthetic appeal.**

**Design relazionale.**

**La linea di poltroncine e divanetti Accord trova  
la sua naturale collocazione in ambienti dedicati  
all'hospitality, grazie alla sua estetica cordiale.**



**ACCORD** sofa and armchair | E03/467 fabric and D06/507 simil leather, Umbra Grey legs  
**MIAMI** side table | Fokos Piombo porcelain stoneware top and Umbra Grey frame  
**T05** coffee table | Umbra Grey lacquer











**The seats are also available in a high backed and sided version, fitted with library tables, USB sockets and magazine rack, for a more pleasant experience while waiting, working or interacting. A perfect ecosystem of privacy and comfort.**

Le sedute sono disponibili anche con schienale e fianchi alti, dotate di scrittoi, prese USB e portariviste per rendere più piacevole l'attesa, il lavoro o il dialogo. Un ecosistema perfetto di privacy e comfort.







ACCORD high-back sofa | P01/095 leather and C05/280 fabric, Umbra Grey legs  
GRACE floor lamp | Natural Linen shade and Black base  
ALALUNGA wall lamp | Bronze  
T05 coffee table | Eucalyptus



200





**The Accord line is available in numerous tonalities and finishings. Dual-colour solutions are also available, with the customisation of the outer part of the upholstery with fabric or leather, different in colour to the inner one, adding a dynamic and fresh touch.**

La linea Accord è disponibile in numerose tonalità e finiture. È possibile scegliere soluzioni bicolor, personalizzando la parte esterna dell'imbottitura con tessuto o pelle di diverso colore rispetto a quella interna per donare dinamismo e freschezza.





designed by Atelier Studio Borella

**Round playfulness.  
Abbey, the line of armchairs,  
sofas and poufs, is an ode  
to softness and harmony,  
in a flourish of shapes and  
colours.**

**Giocosità rotonda.  
La linea di poltrone, divani e pouf Abbey  
è un inno alla morbidezza e all'armonia,  
tra forme e colori.**











**Sinuous and full-bodied shapes inspire playfulness, spontaneous and unconventional use. The seats are available in the armchair and sofa versions, complete with a set of poufs for contract and residential interiors.**

Le forme sono sinuose e piene, invitano al gioco e all'utilizzo in modo spontaneo e non convenzionale. Le sedute sono disponibili nella versione poltrona e divanetto, complete di set di pouf per spazi contract e residenziali.









**Every single piece of the Abbey line is enriched by artisan stitching, which is deliberately imperfect to highlight the human and warm side of design expressed in this collection.**

Ogni pezzo della linea Abbey è arricchito da cuciture a vista artigianali, volutamente imperfette per evidenziare il lato umano e caloroso del design, di cui questa collezione si fa portavoce con la sua esistenza.



ABBEY sofa, armchair and pouf | D03/371, M02/580 and M02/584 fabrics, Umbra Grey varnished beech wood feet  
COZY coffee table | Pigeon Blue lacquered top and Matt White frame  
BABEL floor lamp | White fabric shade and Matt White base



designed by Dorigo Design

**Original gaze.  
Ado is the line that  
surprises the gaze with  
its square and rigorous  
design and sartorial  
finishes that embellish  
living and contract  
interiors.**

**Sguardo inedito.**

**La linea Ado sorprende l'occhio con il  
suo design squadrato e rigoroso e le sue  
lavorazioni sartoriali che impreziosiscono  
spazi living e contract.**









DES

217

ADO sofa and armchair | B03/181 and B03/185 simil leather, Umbra Grey frame and Walnut varnished solid ash wood arms  
WARM floor lamp | White polyethylene shade and Black frame  
T05 coffee table | Umbra Grey lacquer

ADO sofa and armchair | B03/181 and B03/185 simil leather, Umbra Grey frame and Walnut varnished solid ash wood arms  
WARM floor lamp | White polyethylene shade and Black frame  
MIAMI side table | Fokos Piombo porcelain stoneware top and Umbra Grey frame  
T05 coffee table | Umbra Grey lacquer





**Ado armchairs and sofas thrive on contrasts: the softness of upholstery and rigour of the structure, wooden armrests and metal legs. Design shows itself in the details.**

Le poltrone e i divani Ado vivono di contrasti: la morbidezza dell'imbottitura e il rigore della struttura, il legno dei braccioli e il metallo delle gambe. Il design si rivela nei dettagli.

**The shapes of Ado evoke certain stylistic features of Scandinavian: design, essentiality and peacefulness. The seat renews this aesthetic tradition with the Italian style of materials and finishings.**

Le forme di Ado richiamano alcuni stili del design scandinavo: geometria, essenzialità, pacatezza. La seduta rinnova questa tradizione estetica con lo stile italiano dei materiali e delle finiture.





ADO armchair | B03/177 simil leather, Umbra Grey frame and Walnut varnished solid ash wood arms  
WARM floor lamp | White polyethylene shade and Black frame  
COZY coffee table | Umbra Grey lacquered top and Umbra Grey frame

Residential & Hospitality Collection





**The wooden arms of the Ado line feature a special finish: an outward-tapered winged volume creates a dynamic effect and provides comfortable support.**

I braccioli in legno della linea Ado presentano una lavorazione particolare: un volume ad ala che si assottiglia verso l'esterno, creando un effetto dinamico e garantendo un appoggio confortevole.





**ADO** sofa and armchair | M01/590 fabric, Umbra Grey frame and Oak varnished solid ash wood arms  
**ADO** coffee table | White top and Umbra Grey frame  
**MIAMI** metal pot | Umbra Grey





designed by Quadrifoglio Group

**Modular constellation.  
The Astro and Astro Twist  
lines consist of modular  
and customisable  
armchairs, for the tailored  
furnishing of hospitality  
interiors.**

Costellazione modulabile.  
Le linee Astro e Astro Twist sono composte da  
poltroncine componibili e personalizzabili, per  
arredare ad hoc ambienti dedicati all'ospitalità.



ASTRO TWIST composable sofa | M02/575 and M02/582 fabrics, Umbra Grey frame  
OLA MOVE floor lamp | White fibreglass shade  
GOUT pendant lamp | Glossy White glass shade

Residential & Hospitality Collection





**Astro Twist is a version of Astro, featuring rounder lines and ideal for creating curved and soft compositions, with dual-colour matching poufs and coffee tables for personal belongings.**

Astro Twist è una variante della versione Astro, dalle linee più tondeggianti: ideale per creare composizioni curve e morbide, con accostamenti bicolor di pouf e tavolini coordinati per appoggiare i propri effetti personali.







**ASTRO TWIST** composable sofa | E03/460 fabric, Eucalyptus top and Umbra Grey frame  
**MIAMI** side table | Fokos Piombo porcelain stoneware top and Umbra Grey frame  
**Z2** reception desk | Eucalyptus and Brown leather  
**MIRAGE** pendant lamp | Polished Gold shade





ASTRO TWIST composable sofa | C05/280 and C05/281 fabrics, Umbra Grey frame  
MONTREAL side table | Emperador Lucido and Fokos Piombo porcelain stoneware tops, Umbra Grey frame  
CITY LOUNGE armchair | P01/096 leather and C05/280 fabric, Black base  
HALF MOON floor lamp | Black fabric shade and Black base





ASTRO composable sofa | M03/598 and M03/601 fabrics, Umbra Grey frame  
COZY coffee table | White top and frame  
CLOAK pendant acoustic panels | B01/026, B01/012 and B01/014 fabrics





# ARMONY

designed by Dorigo Design

**Infinite possibilities.  
Armony is a modular  
system of beam sofas  
and side tables, designed  
so that the user can  
pleasantly occupy time  
while waiting in business  
and hospitality settings.**

**Infinite possibilità.**

**Armony è un sistema componibile e  
modulare di divanetti a trave e tavolini,  
disegnato per ingannare piacevolmente  
l'attesa in spazi business e hospitality.**







240

**Armony is the result of in-depth research into providing comfort and versatility. The polyurethane upholstery is soft and elastic, while the aluminium legs are solid and essential, seamlessly combining material and intent.**

Armony è frutto di una ricerca approfondita, per offrire comodità e versatilità. L'imbottitura in poliuretano è morbida ed elastica, mentre le gambe in alluminio sono solide ed essenziali: un connubio di materia e intento.



ARMONY | E03/467 fabric and Umbra Grey frame  
T05 coffee table | Ocean Blue and Sik Grey lacquers  
Z1 reception desk | Ocean Blue and Sik Grey lacquers











**Armony enhances each project and adapts to shapes and compositions that are always different. Available with different material, finishing and accessory options, sockets can also be added to the structure.**

Armony asseconda ogni progetto e si lascia plasmare in forme e composizioni sempre diverse. È possibile scegliere tra materiali, finiture e accessori, integrando nella struttura anche prese elettriche.









designed by Quadrifoglio Group

**A pleasant wait.  
Agio is an armchair with  
soft and inviting lines,  
perfect for waiting rooms,  
relaxation areas and  
informal meeting spaces.**

**Piacevole attesa.**

**Agio è una poltroncina dalle linee morbide e  
accoglienti, perfetta per sale d'attesa, aree  
relax e spazi dedicati a meeting informali.**





250

AGIO armchair | E03/460 fabric and Chrome frame  
MONTREAL side table | Nero Greco porcelain stoneware top and Umbra Grey frame  
GRACE floor lamp | Natural Linen shade and Black base



**Agio can be customised with fabrics and leathers, which exalt its soft profile and precious details, including sartorial stitching and the delicate drapery on the inner back.**

Agio si presta a essere personalizzata con tessuti e pelli, che ne esaltino il profilo morbido e mettano in evidenza i dettagli preziosi, quali le cuciture sartoriali e il lieve drappeggio all'interno dello schienale.



AGIO armchair | P01/096 leather and Chrome frame  
MONTREAL side table | Invisible White porcelain stoneware top and Umbra Grey frame  
TUBE MICRO pendant lamp | Gold



DESIGN LIVING





AGIO armchair | E04/475 fabric and Chrome frame  
MONTREAL side table | Noir Desir porcelain stoneware top and Bronze frame  
OLA MOVE floor lamp | White fibreglass shade

DESIGN LIVING





designed by Quadrifoglio Group

**Geometric coherence.  
Alias is a compact and  
rational armchair, suitable  
for meeting areas,  
waiting rooms, halls and  
conference rooms.**

**Coerenza geometrica.  
Alias è una poltrona compatta e razionale,  
adatta ad arredare spazi per riunioni, sale  
d'attesa, hall e aule per conferenze.**









**Alias is available in a tub chair version or with a wheel base, to accommodate all needs. Its upholstery guarantees composed and measured comfort, without ever deforming.**

A seconda delle esigenze, Alias è disponibile sia nella versione pozzetto, sia in quella con la base dotata di rotelle. L'imbottitura assicura un comfort composto e misurato senza deformarsi.







# Accessories & Side Tables Index

---

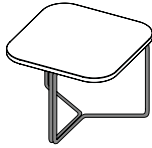

MONTREAL

---

264 | 271



MIAMI

---

272 | 281

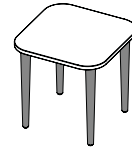

MELBOURNE

---

282 | 287



COZY

---

288 | 295

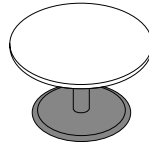

T01

---

296 | 299

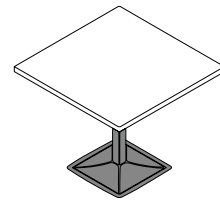

T02

---

300 | 307

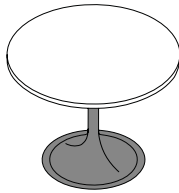

T03

---

308 | 313

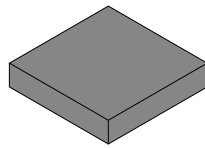

T05

---

314 | 319

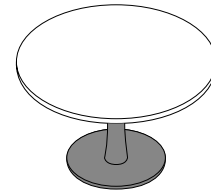

T06

---

320 | 325



FLIPPER

---

326 | 331

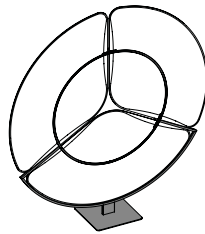

PETAL&CLOAK

---

332 | 339

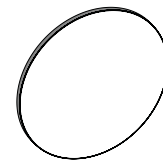

ALTER EGO

---

340 | 345



# MONTREAL

designed by Quadrifoglio Group

**Dynamic lines.  
The Montreal collection is  
designed for residential  
interiors, hotels and  
convivial areas, where  
the side table becomes a  
focal point of areas.**

Linee dinamiche.

La collezione Montreal è disegnata per ambienti  
residenziali, hotel e luoghi di convivialità, dove il tavolino  
diventa interlocutore privilegiato dello spazio.



MONTREAL side table | Invisible White and Fokos Piombo porcelain stoneware tops, Umbra Grey frame  
ARTE sofa | E04/480 fabric and Chrome legs

Residential & Hospitality Collection







**The steel rebar base supports the top with grace and lightness, in a harmonious coexistence.**

**The side tables are available in different heights and finishings, creating unique complicities each time.**

La base in tondino di acciaio sorregge il piano con grazia e leggerezza, creando un'armonica convivenza. I tavolini sono disponibili in diverse altezze e finiture, per creare ogni volta complicità uniche.

MONTREAL side table | Invisible White and Nero Greco porcelain stoneware tops, Umbra Grey frame  
AGIO armchair | E03/460 fabric and Chrome frame  
GRACE floor lamp | Natural Linen shade and Black base

DESIGN LIVING





**Montreal table tops are available in different shapes and sizes; they can be customised, with porcelain stoneware, lacquered or melamine options to suit the desired mood.**

Il piano dei tavolini Montreal è disponibile in diverse forme e dimensioni e si può personalizzare in gres porcellanato, in laccato o in melaminico, a seconda del mood che si vuole dare all'ambiente.









designed by Quadrifoglio Group

**Dual personality.  
Understated design and  
original finishings coexist in  
the Miami collection of side  
tables, poufs and containers,  
designed for home and  
hospitality settings.**

**Personalità duale.  
Design minimal e finiture ricercate convivono  
nella collezione di tavolini, pouf e contenitori  
Miami, pensata per il residenziale e l'hospitality.**



MIAMI side table | Emperador Lucido porcelain stoneware top and Umbra Grey frame  
AVANA sofa | E04/490 fabric and Umbra Grey legs

Residential & Hospitality Collection





**MIAMI** side table | Fokos Piombo porcelain stoneware tops and Umbra Grey frame  
**ASTRO TWIST** composable sofa | E03/460 fabric, Eucalyptus top and Umbra Grey frame  
**Z2** reception desk | Eucalyptus and Brown leather  
**MIRAGE** pendant lamp | Polished Gold shade





**The Miami collection furnishes interiors with grace and coherence and includes containers for belongings fitted with bases of different heights, also designed to act as planters.**

Per arredare ogni spazio con garbo e coerenza, nella collezione Miami sono presenti i contenitori per oggetti con basi di diverse altezze, progettati anche per fungere da portavasi per le piante.



**Side tables are the leitmotif of this collection: they engage in dialogue with poufs and pots and are available in a multitude of versions, with different heights and top shapes.**

I tavolini sono l'elemento di raccordo della collezione: dialogano sia con i pouf che con i contenitori e sono disponibili in molteplici versioni, con altezza e forma del piano differenti.



MIAMI side table | Emperador Lucido porcelain stoneware top and Bronze frame  
MIAMI pouf | E04/486 fabric and Bronze frame  
AVANA composable sofa | D04/387 fabric and Umbra Grey legs

DESIGN LIVING





**The top can be finished with porcelain stoneware, melamine or lacquered options. Its metal edges exalt the style of all settings: from chalets to city apartments, hotels or airports.**

Il piano è rifinibile in gres porcellanato, melaminico o laccato. I suoi bordi in metallo esaltano lo stile di ogni contesto: che sia uno chalet, un appartamento di città, un hotel o un aeroporto.







# MELBOURNE

designed by Quadrifoglio Group

**Fertile pairings.  
Side tables, poufs and  
pots from the Melbourne  
collection can be  
assembled together,  
bringing to life to classic  
public and private interiors.**

**Fertili combinazioni.  
I tavolini, pouf e contenitori della linea Melbourne  
sono combinabili tra loro per dare vita a spazi  
classici, pubblici e privati.**



MELBOURNE side table | Nero Greco and Invisible White porcelain stoneware top and Oak varnished solid ash wood legs  
MELBOURNE pouf | E04/490 fabric and Oak varnished solid ash wood legs  
MELBOURNE metal pot | Umbra Grey pot and Oak varnished solid ash wood legs  
ARTE sofa | I01/519 fabric and Chrome legs







**The frames of accessories are wooden and feature conical legs, inspired by nordic taste, giving the design a rounder and warmer feel.**

Le strutture dei complementi d'arredo sono realizzati in legno e hanno gambe coniche ispirate al gusto nordico, per dare un gusto più rotondo e caloroso al design.







designed by Dorigo Design

**Multiform presence.  
Cozy coffee tables are  
dynamic, playful and  
available in various  
shapes and sizes,  
ideal for convivial or  
private spaces.**

**Multiforme presenza.  
I tavolini Cozy sono dinamici e giocosi,  
disponibili in varie forme e dimensioni, ideali  
per ambienti conviviali o spazi raccolti.**



COZY coffee table | Beige lacquered top and Umbra Grey varnished solid ash wood legs  
COVE design chair | D02/268 fabric, Umbra Grey varnished solid ash wood legs  
CD LED pendant and table lamp | Black





**Cozy coffee tables with a round or square top are recommended to enhance stylishly even the smallest areas of spaces, and are perfect in home and hospitality settings.**

I tavolini Cozy, con piano rotondo o quadrato, sono indicati per valorizzare con stile anche aree dalle metrature ridotte e sono perfetti sia per contesti residenziali che per strutture ricettive.





COZY coffee table | Umbra Grey lacquered top and Umbra Grey varnished solid ash wood legs

**COZY** coffee table | White and Pigeon Blue lacquered tops, Matt White frame  
**ABBEY** armchair | D03/371, M02/580 and M02/584 fabrics, Umbra Grey varnished beech wood feet  
**BABEL** floor lamp | White fabric shade and Matt White base







**Coffee table versions, with a metal structure and tops that are customisable with different tonalities, add colour and personality to shared spaces.**

Le versioni dei tavolini con struttura in metallo e piani customizzabili in diverse tonalità donano colore e personalità ai contesti di condivisione.



designed by Quadrifoglio Group

**Regal stability.  
The top and base of the T01  
coffee tables are round,  
appearing reflected in an  
impeccable and extensively  
customisable symmetry.**

**Imperiosa stabilità.  
Il piano e il basamento dei tavolini T01 sono  
circolari e sembrano riflettersi in una esemplare  
specularità, tutta da personalizzare.**



**T01 is available in a tall or low version, with round top. This line is suitable for indoor and covered outdoor settings, for both home and hospitality.**

T01 è disponibile in versione alta o bassa, con piano circolare. Questa linea si adatta a contesti indoor e outdoor al coperto in ambienti residenziali o di hospitality.



T01 high tables | Oak top and White frame  
COVE high stool | White polypropylene shell and D06/507 simil leather upholstered seat, Chrome frame

DESIGN LIVING





designed by Quadrifoglio Group

**Rational cross-section.  
T02 is a series of coffee  
tables with a pyramid  
base and square top,  
designed for essential  
interiors with an  
understated taste.**

Sezione razionale.

T02 è una serie di tavolini con basamento  
piramidale e piano quadrato, pensati per  
ambienti essenziali dal gusto minimal.



T02 coffee table | Eucalyptus top and Umbra Grey frame  
CITY DÉCO LOUNGE armchair | E04/490 fabric and Bronze frame

Residential & Hospitality Collection







**The painted metal base and melamine wood top engage in a matching or contrasting dialogue, creating demure or dynamic pairings, suitable for modern settings.**

La base in metallo verniciato e il piano in essenza melaminica dialogano in armonia o per contrasto, creando abbinamenti posati o dinamici, adatti a contesti moderni.



304

T02 coffee table | Oak top and Umbra Grey frame

CODE design chair | Umbra Grey lacquered and Oak varnished solid ash wood shell, Chrome legs



**The simplicity of T02 is developed in different shapes and styles: the coffee table is available in three heights, each in turn with different sizes, tops and finishings, furnishing any interior with allure and discretion.**

La semplicità di T02 si declina in varie forme e stili:  
il tavolino è disponibile in tre altezze, diverse per  
dimensione del piano e finiture, per arredare ogni spazio  
con decisione e discrezione.



T02 high table | Oak top and Umbra Grey frame  
COVE high stool | Oak varnished solid ash wood shell and Chrome legs

DESIGN LIVING





designed by Quadrifoglio Group

**Perpetual essentiality.  
T03 is a collection of  
coffee tables with a  
biconic base and round  
top, designed for public  
and private settings.**

**Essenzialità perpetua.  
T03 è una collezione di tavolini con basamento  
biconico e piano circolare, progettati per diversi  
contesti, pubblici e privati.**











**The melamine top and painted metal base develop in a continuous shape, which is customisable in size, height and finishings, for convivial interiors.**

Il piano in melaminico e il basamento in metallo verniciato si articolano in una forma continua, personalizzabile nelle dimensioni, nell'altezza e nelle finiture, per integrarsi in ambienti conviviali.



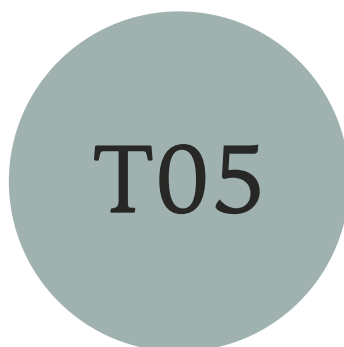

designed by Quadrifoglio Group

**Natural accessory.  
T05 is a line of square  
or rectangular coffee  
tables with powerful and  
authoritative volumes, for  
the enhanced definition  
of spaces.**

**Naturale completamento.  
T05 è una linea di tavolini, quadrati o rettangolari,  
con volumi possenti e autorevoli, realizzati per  
definire al meglio gli spazi.**



T05 coffee table | Eucalyptus  
MIAMI side table | Fokos Terra porcelain stoneware top and Umbra Grey frame  
ACCORD sofa | C05/280 fabric and P01/095 leather, Umbra Grey legs





**45° angles join lacquered and melamine tops, adding character to T05 and enabling harmonious interaction with surrounding furnishing accessories.**

Gli angoli di unione a 45° racchiudono le finiture in laccato e melaminico, donano carattere a T05 e instaurano una relazione armonica con i complementi d'arredo intorno.



318

T05 coffee table | Ocean Blue and Sik Grey lacquers  
MIAMI side table | Umbra Grey lacquered top and Umbra Grey frame  
ARMONY | E03/467 fabric and Umbra Grey frame





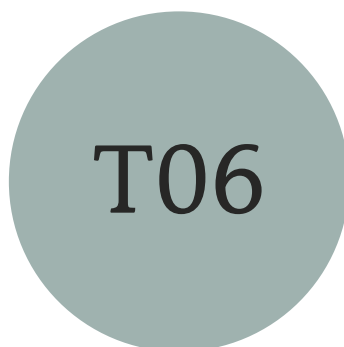

designed by Quadrifoglio Group

**A celebration of  
conviviality.  
T06 is a table designed  
to be at the centre of  
convivial moments and is  
perfect for restaurants,  
cocktail bars and  
cafeterias.**

**Celebrazione della convivialità.  
T06 è un tavolo nato per essere al centro di  
momenti conviviali ed è perfetto per ristoranti,  
cocktail bar e caffetterie.**



**The classic round table is reinterpreted by the flared leg that joins the painted metal base to the top, customisable in melamine, for enhanced compactness, or glass, for a superlative lightness.**

Il classico tavolo tondo è rivisitato dal gambone svasato che unisce il basamento in metallo verniciato e il piano, personalizzabile in melaminico per una maggiore compattezza o in vetro per una totale leggerezza.





323

T06 coffee table | Elm top and Umbra Grey frame  
CD LED pendant and table lamp | Black  
COVE design chair | D02/268 and D02/277 fabric, Umbra Grey varnished solid ash wood legs







# FLIPPER

designed by Edi & Paolo Ciani

**Domestic alliances.  
Slender, simple and  
functional: Flipper is  
a side table that also  
acts as a desk for smart  
working.**

**Alleanze domestiche.  
Snello, semplice e funzionale: Flipper è un tavolino che  
funge anche da scrivania per lo smart working.**







FLIPPER home office table | White top and Umbra Grey frame  
AVANA composable sofa | E02/438 fabric and Umbra Grey legs  
COMPASSO design chair | Walnut varnished solid ash wood frame and D03/363 fabric seat  
FIVE table | Canaletto Walnut top and Umbra Grey frame



FLIPPER home office table | White top and Umbra Grey frame  
MOON design chair | Umbra Grey polypropylene frame and E01/431 fabric upholstered soft pads  
ZEFIRO bookshelves | Umbra Grey lacquer

Residential & Hospitality Collection



**Available with a butterfly or four-legged base, featuring a sliding top with a space for sockets and a hide-away book rest. It closes to become a perfect side table for living interiors.**

Disponibile con basamento a farfalla o a quattro gambe, ha il piano scorrevole con uno spazio per le prese e un leggio a scomparsa. Una volta chiuso diventa un perfetto tavolino living.





# PETAL & CLOAK

designed by Moreno De Giorgio

**Soft silence.  
Petal & Cloak is a series  
of sound-absorbing  
panels designed to  
enhance acoustic well-  
being in large interiors  
and open spaces.**

**Silenzio morbido.  
Petal & Cloak è una serie di pannelli  
fonoassorbenti pensata per aumentare il  
benessere uditivo in spazi ampi e open space.**











336

PETAL floor stand with acoustic panels | B01/020, B01/009 and B01/024 fabrics, Matt White frame  
CODE high stool | Oak varnished solid ash wood shell with C05/280 upholstered seat, Chrome frame  
ADO sofa and armchair | M01/590 fabric, Umbra Grey frame and Oak varnished solid ash wood arms





338

PETAL floor stand with acoustic panels | B01/026, B01/012 and B01/014 fabrics, Matt White frame

**Petal & Cloak is available in the cascade, ceiling hung or free-standing version with base. The multicoloured panels vibrantly furnish shared interiors and can be customised.**

Petal & Cloak è disponibile nella variante a cascata, a sospensione da soffitto o in quella a piantana, con base a terra. I pannelli multicolor arredano con vivacità gli spazi condivisi e possono essere personalizzati.





# ALTER EGO

designed by Quadrifoglio Group

**Reflections of identity.  
Alter Ego is a collection  
of back-lit mirrors that  
are perfect for furnishing  
lounge areas, restaurants  
and bars.**

**Riflessi di identità.  
Alter Ego è una collezione di specchi  
retroilluminati, perfetti per arredare aree  
living, ristoranti e bar.**







**Each mirror contains and reflects space, enhancing perception of the interior while spreading a suffused and atmospheric light, ideal for home and hospitality settings.**

Ogni specchio contiene e riflette lo spazio, ampliando la percezione dell'ambiente e diffondendo una luce soffusa e atmosferica, ideale sia per ambienti domestici che per locali di hospitality.





344

ALTER EGO mirrors  
ADD pendant lamp | Glossy Bronze shade  
COVE design chair | E04/475 and E04/476 fabrics and Umbra Grey varnished solid ash wood legs





# Living Tables Index

---

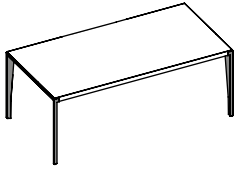

NINE

---

348 | 353

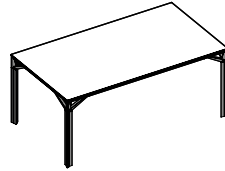

EIGHT

---

354 | 359

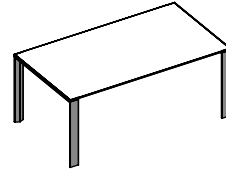

SEVEN

---

360 | 365

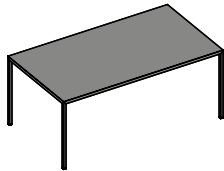

SIX

---

366 | 373

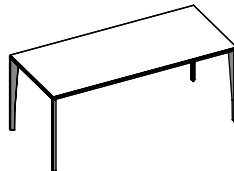

FIVE

---

374 | 382

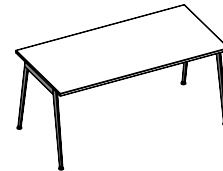

THREE

---

383 | 388



TWO

---

389 | 393

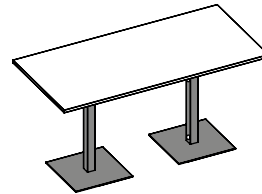

CREO & GREKO

---

394 | 401



designed by GabrielPolloni Associati

**Aesthetic synthesis.  
Nine is the archetype  
of the table for sharing,  
perfect for dining  
rooms, tasting areas or  
hospitality interiors.**

**Sintesi estetica.**

**Nine è l'archetipo del tavolo per la condivisione,  
perfetto per una sala da pranzo, un'area degustazione  
o un ambiente dedicato all'ospitalità.**



NINE table | Ebony top and Umbra Grey legs  
CITY design chair | P01/095 leather and Umbra Grey frame  
BLONDE pendant lamp | Gold

Residential & Hospitality Collection







**The veneered wood top is built into the metal structure featuring unique carvings. The presence of wood, matched with the matt tonalities of the legs, enhance the refinement of the table, making it an authentic interpretation of interior style.**

Il piano in legno impiallacciato è incassato nella struttura in metallo dall'intaglio peculiare. La presenza del legno, accostato alle tonalità opache delle gambe, rende il tavolo pregiato e ne fa un autentico interprete dello stile dell'ambiente.



NINE table | American Walnut top and Umbra Grey frame  
CLUE design chair | P01/095 leather and Oak varnished solid ash wood legs  
OLA pendant lamp | White fibreglass shade  
OLA MOVE floor lamp | White fibreglass shade

DESIGN LIVING





designed by GabrielPolloni Associati

**An orchestra of elements.  
A unique table, manifold  
ways of experiencing it:  
Eight comes with  
customisable finishings  
so that it matches living  
and hospitality interiors.**

Orchestra di elementi.  
Un unico tavolo, numerosi modi di viverlo:  
Eight è personalizzabile nelle finiture per  
intornarlo ad ambienti living o di hospitality.





356

**EIGHT** table | Umbra Grey lacquered top and Matt White frame  
**CITY** design chair | C05/280 fabric and Walnut varnished solid ash wood  
**GRACE** pendant lamp | Natural Linen shade





358

**EIGHT** table | Eucalyptus top and Bronze frame  
**CLUE** design chair | D04/398 fabric and Bronze frame  
**BABEL** pendant lamp | Black shade





**The shape of the metal legs evokes the profile of a branch, flowing into the clear-cut geometry of the top, customisable with lacquered, glass or melamine in different colour options.**

La forma delle gambe in metallo evoca il profilo di un ramo, che confluisce nella geometria netta del piano, customizzabile in laccato, vetro o melaminico di diversi colori.





designed by GabrielPolloni Associati

**Here and now.  
Ideal for home or  
restaurant kitchens and  
dining rooms, Seven  
embraces moments of  
conviviality.**

Qui e ora.  
Ideale per una cucina, per la sala da pranzo di  
un'abitazione o di un ristorante, Seven accoglie  
intorno a sé i momenti di convivialità.





362

SEVEN table | Canaletto Walnut top and Bronze frame  
CODE design chair | Walnut varnished solid ash wood shell and legs  
ZEFIRO bookshelves | Umbra Grey lacquer  
STARLIGHT GIANT wall lamp | Bronze



**SEVEN** table | Canaletto Walnut top and Chrome frame  
**DIVA SOFT** executive chair | C05/280 fabric  
**GRACE** table lamp | Natural Linen shade and Black base  
**BOISERIE** | Canaletto Walnut back and Umbra Grey lacquered doors



**Slender profiles, accompanied by legs, in an open or closed version: Seven can also become a studio desk, based on selected finishings and tonalities, including white, bronze and gold.**

Profili sottili, accompagnati da gambe in versione aperta o chiusa: Seven può diventare anche la scrivania di uno studio, a seconda delle finiture e delle tonalità selezionate, tra cui bianco, bronzo e oro.

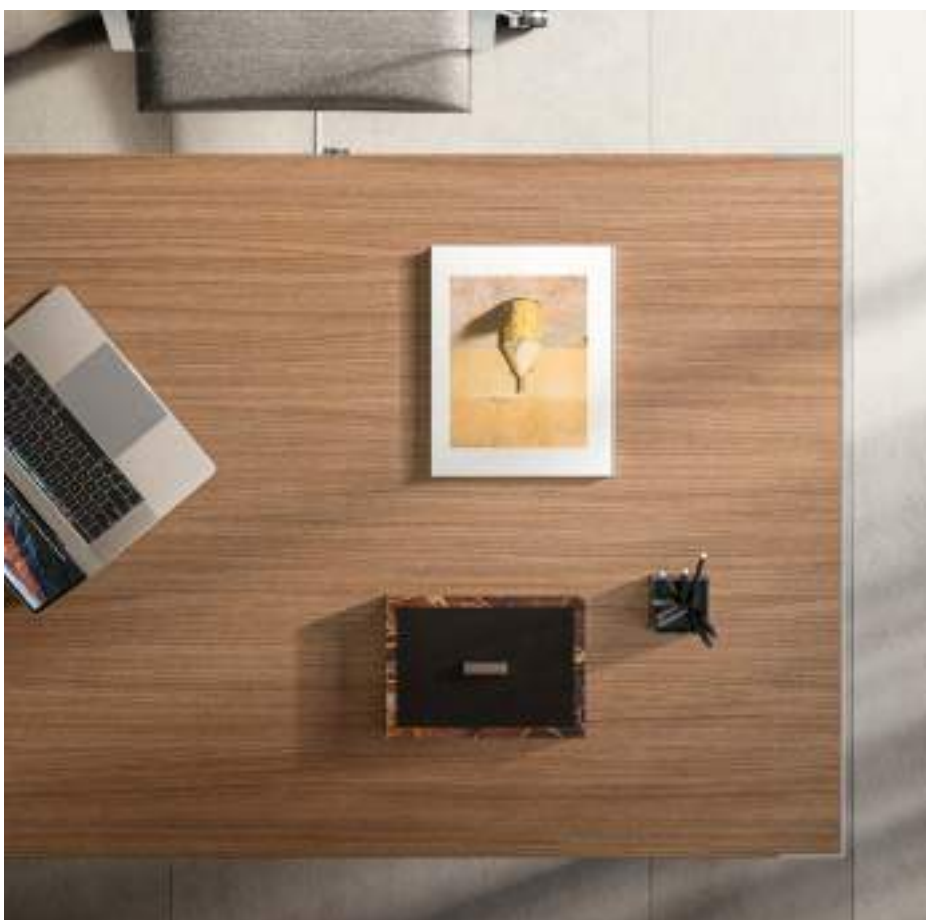



designed by Quadrifoglio Group

**Subtle elegance.  
Suitable for residential  
and contract interiors,  
with its patented design  
Six is customisable with  
refined finishings that  
exalt its slender profiles.**

**Sottile eleganza.  
Adatto per ambienti residenziali e contract, Six con  
il suo design brevettato, è personalizzabile con  
finiture di pregio per esaltarne i profili sottili.**











**Legs and structure seamlessly blend together in just 30×30 mm, enhancing the table with a slender grace. The product matches different styles, thanks to the extensive selection of available colours and finishings, including porcelain stoneware for the top.**

**Gambe e struttura si fondono in soli 30×30 mm e conferiscono al tavolo una grazia esile. Il prodotto asseconda stili differenti, grazie all'ampia scelta di colori e finiture a disposizione, tra cui il gres porcellanato per il piano.**





371

SIX table | Umbra Grey frame and Invisible White porcelain stoneware top  
CODE design chair | Walnut varnished solid ash wood legs and shell, C05/280 fabric seat  
BLOOM credenza | American Walnut doors and sides, Invisible White porcelain stoneware top  
AFRA pendant lamp | Matt White acid-etched glass shade



372

SIX table | Matt white frame and Invisible White porcelain stoneware top  
CELL chair | Blue and Ocher  
WARM floor lamp | White polyethylene shade and Black frame





designed by GabrielPolloni Associati

**Ubiquitous potential.  
Home office, kitchen,  
restaurant, cocktail bar:  
Five enhances any interior  
with its structure featuring  
a distinctive folding.**

Potenziale ubiquo.  
Home office, cucina, ristorante, cocktail bar: non c'è  
ambiente che Five non sappia valorizzare con la sua  
struttura dalla piegatura distintiva.







376

**FIVE** table | Eucalyptus top and Umbra Grey frame  
**COMPASSO** design chair | Umbra Grey varnished solid ash wood frame and B03/185 simil leather seat  
**CARTESIO** ceiling track with Globe lights | Black





378

FIVE table | Canaletto Walnut top and Umbra Grey frame  
COMPASSO design chair | Walnut varnished solid ash wood frame and D03/363 fabric seat  
ADD pendant lamp | Matt clay shade





**Five is designed for contract and home use; it is available in different sizes and the top can either be 80mm or 90mm in depth. The surface top is available in eight melamine versions, which can be paired with legs of different colours.**

Five è disegnato per destinazioni d'uso contract e private: è disponibile in diverse dimensioni e il piano può avere profondità 80mm o 90mm. La superficie d'appoggio è realizzabile in otto varianti di melaminico, da accostare ai diversi colori delle gambe.



FIVE table | Umbra Grey frame and Whitened Elm top  
CODE design chair | Walnut varnished solid ash wood legs and shell, C05/303 fabric seat  
P1 BOISERIE | Whitened Elm panels and shelves, Umbra Grey tracks

DESIGN LIVING





designed by Quadrifoglio Group

**Multiple identity.  
Customisable and versatile:  
Three is perfect for canteens,  
restaurants or home interiors as  
a library table for the bedroom.  
Its design is linear yet distinctive,  
featuring an understated leg  
with a conical section, the  
fulcrum of its personality.**

**Identità molteplice.**

**Personalizzabile e versatile: Three è perfetto per mense, ristoranti o contesti residenziali come scrittoio. Il suo design è lineare eppure peculiare con la gamba minimal a sezione conica, il fulcro della sua personalità.**





THREE table | Umbra Grey and Oak legs, Umbra Grey lacquered top  
CITY design chair | E03/467 fabric and Oak varnished solid ash wood legs  
MINISTICK table lamp | Black  
ABBEY pouf | E03/467 and E03/465 fabrics







386

**THREE** table | Oak top and Umbra Grey legs  
**CODE** design chair | Oak varnished solid ash wood shell and legs





designed by Quadrifoglio Group

**Visions of style.  
Two is the natural  
addition to home interiors  
as a living room table,  
ideal for lunch, studying  
or working.**

**Visioni di stile.  
Two trova la sua naturale collocazione in  
ambienti residenziali come tavolo da salotto,  
ideale per pranzare, studiare o lavorare.**



**TWO** table | Canaletto Walnut top and White frame  
**CLUE** design chair | White polypropylene shell and D02/270 fabric upholstered seat, Walnut varnished solid ash wood legs  
**BOISERIE** | Canaletto Walnut back and Silk Grey lacquered top  
**SUN** pendant lamp | White fabric shade





**Two is available with an oval or square melamine top, in a selection of nine different versions. The tubular legs can be customised in white, grey or aluminium and ramify on the floors, bringing to life a table with an original appearance.**

Two è disponibile con piano in melaminico ovale o quadrato, a scelta tra 9 tipi di varianti. Le gambe tubolari, personalizzabili in bianco, grigio o alluminio, si ramificano a terra dando al tavolo un aspetto ricercato.



TWO table | Eucalyptus top and Umbra Grey frame  
COVE design chair | D02/275 fabric and Umbra Grey frame  
MIRAGE pendant lamp | Gold

DESIGN LIVING





# CREO & GREKO

designed by Quadrifoglio Group

**Close destinies.  
Creo and Greko are two  
tables featuring a geometric  
and rigorous design,  
which welcome people  
in meticulously designed  
convivial interiors.**

**Destini fratelli.**

**Creo e Greko sono due tavoli dal design  
geometrico e rigoroso, capaci di accogliere le  
persone in spazi conviviali progettati con cura.**



GREKO high table | Elm top and Umbra Grey frame  
COVE high stool | C05/280 fabric and Chrome legs  
HALF MOON floor lamp | Black fabric shade and Black frame

Residential & Hospitality Collection





**Creo and Greko provide  
infinite customisation  
possibilities, thanks  
to tops available in  
different sizes.**

Creo e Greko offrono infinite possibilità  
di personalizzazione, grazie ai piani  
realizzabili in diverse dimensioni.





CREO high table | Oak top and White frame  
CELSIUS high stool | White and Ocher lacquered shell and Chrome legs  
DRINK pendant lamp | White



DESIGN LIVING





401

**CREO** high table | Oak top and Umbra Grey frame  
**CODE** high stool | Oak shell and D04/386 fabric seat, Chrome frame  
**CODE** design chair | Umbra Grey lacquered shell and legs, B03/185 simil leather seat  
**COZY** coffee table | Umbra Grey lacquered top and Umbra Grey varnished solid ash wood frame



# Storage & Partitioning Index

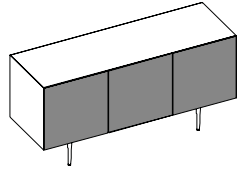

BLOOM

404 | 413

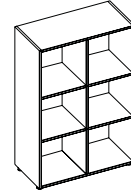

ZEFIRO

414 | 419

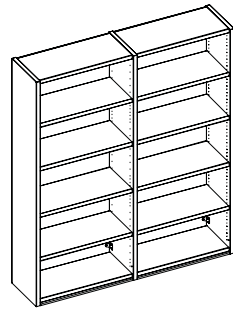

LIBRERIA

420 | 425

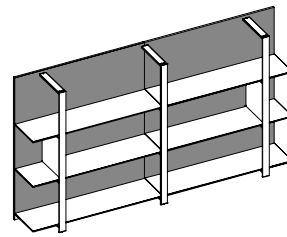

BOISERIE

426 | 431

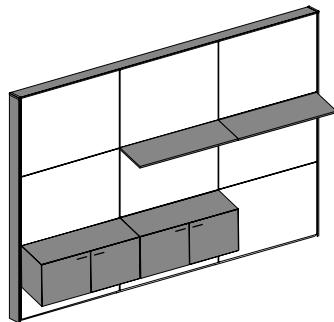

P1  
BOISERIE

432 | 437

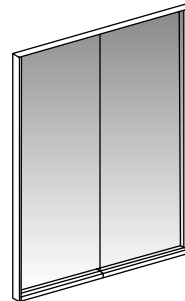

M3

438 | 445



designed by Quadrifoglio Group

**A flourish of design.  
Bloom is the credenza  
designed by Quadrifoglio  
Group to furnish  
entrances, lounges and  
bedrooms in home and  
hospitality settings.**

Design sbocciato.

Bloom è la credenza firmata Quadrifoglio Group,  
disegnata per arredare ingressi, soggiorni e camere  
da letto in contesti living e hospitality.











**The aesthetic appeal of Bloom is also due to the absence of handles on doors, which are fitted with a push&pull mechanism, and the 45° joints, generating a continuous form for the eye to behold. Bloom is customisable with materials selected to embellish interiors.**

L'estetica essenziale di Bloom è merito delle ante senza maniglie, dotate di un meccanismo push&pull e delle giunzioni angolari a 45°, che suggeriscono all'occhio una forma continua. Bloom è personalizzabile con materiali selezionati per impreziosire gli spazi.



BLOOM credenza | American Walnut doors, sides and top, Bronze Bridgy legs



DESIGN LIVING



410



**Bloom responds to different functional requirements: it is fitted with internal glass shelves that can be removed if not used; numerous customisation options are also available, from finishings to feet.**

Bloom risponde a esigenze di funzione diverse: è accessoriata con ripiani interni in vetro che si possono rimuovere se non utilizzati e offre varie possibilità di personalizzazione, dalle finiture ai piedini.





**The feet are also customisable with Bloom, available in different shapes, like the more classic wooden Eden or the more outgoing metal Flair, setting the tone for interiors.**

Bloom è customizzabile anche nei piedini, disponibili di diverse forme, come il modello più classico Eden in legno o il più estroso Flair in metallo, per dettare il carattere degli ambienti.



BLOOM credenza | Noir Desir porcelain stoneware doors, Umbra Grey lacquered top and sides, Bronze Flair legs



designed by Quadrifoglio Group

**A puff of lightness.  
An open bookcase  
with an understated  
design, modular and  
customisation for home  
and Ho.Re.Ca settings.**

**Soffio di leggerezza.  
Una libreria a giorno dal design minimal e leggero,  
componibile e personalizzabile per ambienti  
residenziali e Ho.Re.Ca.**







**Univocal furnishing with manifold styles, generated by the selection of finishings and tonalities. Lacquered or melamine, with abs or metal feet available in different shape. Zefiro fulfils all project requirements.**

Un arredo univoco con molteplici stili a seconda delle finiture e delle tonalità che si scelgono. Laccato o melaminico, con piedini in abs o metallo di diverse forme: Zefiro asseconda ogni esigenza di progetto.



ZEFIRO bookshelves | Pigeon Blue lacquer with Classic White legs  
TURN ME! wall lamp | Matt White  
ABBEY pouf | E04/491 fabric  
ALTER EGO mirror

DESIGN LIVING





**Zefiro is available in a basic, maxi and super version, adapting to interiors of different sizes, and is customisable with tailored melamine, leather or veneered wood doors, matching with the palette.**

Zefiro è modulabile in versione base, maxi e super per adattarsi a contesti di diversa metratura ed è personalizzabile con ante su misura in melaminico, cuoietto o impiallacciato, coordinate alla palette d'insieme.





# LIBRERIA

designed by Quadrifoglio Group

**An architecture of  
knowledge.  
A modular structure,  
perfect for studios,  
offices, waiting rooms  
and lounge areas,  
customisable with  
numerous finishings.**

**Architettura del sapere.  
Una struttura modulare perfetta per studi, uffici,  
sale d'attesa e zone lounge, customizzabile in  
numeroso finiture.**



LIBRERIA bookshelves | Elm  
ASTRO TWIST composable sofa | C05/281 fabric and Umbra Grey frame

Residential & Hospitality Collection













# BOISERIE

designed by Quadrifoglio Group

**Tradition, reinvented.  
A modular composition  
of shelves and units, with  
customisable finishings:  
ideal for home offices,  
shared spaces or hotel  
reception areas.**

**Tradizione reinventata.  
Una composizione modulabile di ripiani e mobiletti,  
personalizzabile nelle finiture: ideale per un home office, uno  
spazio condiviso o un'area di accoglienza in hotel.**



**BOISERIE** | Canaletto Walnut back and Umbra Grey lacquered doors, Chrome uprights  
**SEVEN** table | Canaletto Walnut top and Chrome frame  
**DIVA SOFT** executive chair | C05/280 fabric

Residential & Hospitality Collection







430

**BOISERIE** | Canaletto Walnut back and Silk Grey lacquered doors, White uprights  
**MOON** design chair | White polypropylene shell and E01/421 fabric upholstered soft pads







designed by Quadrifoglio Group

**Optimised space.  
P1 is a boiserie with  
built-in shelves and  
units, furnishing walls  
with personality,  
adding elegance and  
functionality to home or  
professional interiors.**

**Spazio ottimizzato.  
P1 è una boiserie con mensole e mobili  
integrati nei pannelli, per arredare una parete  
con personalità e rendere eleganti e funzionali  
contesti residenziali o professionali.**





434

P1 Boiserie | American Walnut panels and shelves  
CITY design chair | E04/488 fabric and Gold frame  
MELBOURNE metal pot | Umbra Grey pot and Oak varnished solid ash wood legs



P1 Boiserie | Ebony panels and Umbra Grey lacquered floating elements  
BABEL floor lamp | Black fabric shade and Matt White base  
MONTREAL side table | Fokos Piombo porcelain stoneware top and Umbra Grey frame

Residential & Hospitality Collection







designed by Quadrifoglio Group

**Redrawing the boundaries.  
M3 is a system of dividing  
and sound-absorbing  
glass walls that are  
perfect for delicately  
configuring living and  
hospitality interiors.**

**Ridisegnare i confini.**

**M3 è un sistema di pareti divisorie e fonoisolanti  
in vetro, perfette per configurare spazi living e  
hospitality con delicatezza.**





M3 glazed partition | Bronze tracks  
ABBEY pouf | E04/492 fabric

Residential & Hospitality Collection

440



**M3 consists of single-slab glasses and is characterised by slender and discrete profiles, customisable in wood, bronze, corten, gold and other colours, articulating spaces of walk-in wardrobes, dining rooms or relaxation areas, enveloping people in padded acoustic comfort.**

M3 è composto da vetri monolastra ed è caratterizzato da profili snelli e discreti, customizzabili in legno, bronzo, corten, oro e altri colori, per articolare gli spazi di cabine armadio, sale da pranzo o zone relax, avvolgendo le persone in un comfort acustico ovattato.





442

M3 glazed partition | Umbra Grey tracks  
ABBEY pouf | 102/535 fabric  
ALTER EGO mirrors  
BLOOM credenza | Invisible White porcelain stoneware top, Umbra Grey lacquered doors and sides, Umbra Grey legs



**The M3 system provides hinged or sliding door options as well as a choice of handles. Glasses are also available in a matt version to guarantee more privacy.**

Il sistema M3 offre la possibilità di scegliere tra porte a battente o scorrevoli e tra diverse tipologie di maniglie. I vetri sono disponibili anche in versione opacizzata per garantire maggior privacy.



M3 glazed partition | Elm covered tracks  
OLA pendant lamp | White fibreglass shade  
COVE design chair | E04/488 fabric and White frame  
SIX table | Invisible White porcelain stoneware top and Matt White frame





1.

2.



3.



5.



4.

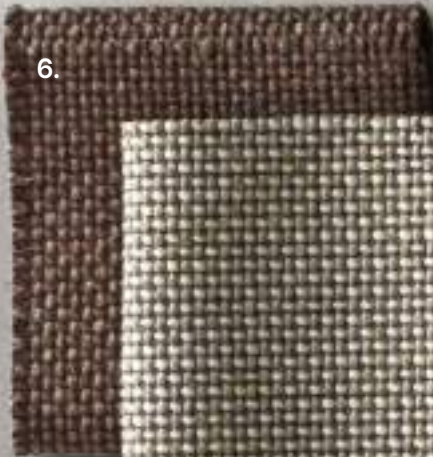

6.

7.



8.



## WARM COLOURS MOODBOARD

---

**Walnut, dark brown, beige and grey nuances mingle to generate an earthy and homely ambience, ideal for warm, friendly and prestigious settings.**

Nuance di noce, testa di moro, beige e grigio si accostano restituendo un'atmosfera di terra e appartenenza, ideale per ambienti calorosi, affabili e prestigiosi.



## COOL COLOURS MOODBOARD

---

**Smooth porcelain stoneware surfaces and fabric patterns conquer space, expressed by veinings and shininess, between tenuous and abstract tonalities.**

Superfici lisce di gres porcellanato e trame di tessuti conquistano lo spazio, articolandosi in venature e lucentezze, tra tonalità polverose e astratte.

So·Ah

1.

2.

3.

4.

5.

6.

7.

8.

9.



# NATURAL COLOURS MOODBOARD

---

**Fertile contrasts between  
tenuous and vibrant colours,  
like burnt orange and corten,  
invite the eye to a light dance,  
in places that evoke nature,  
welcoming and decisive.**

Contrasti fertili tra colori tenui e accesi come  
l'arancio bruciato e il corten invitano l'occhio a una  
danza leggera e lo fanno accomodare in luoghi che  
richiamano la natura, accoglienti e decisi.

1. Fokos Terra porcelain stoneware (LFT) / Gres porcellanato Fokos Terra (LFT) 2. Corten metal (CO) / Metallo Corten (CO)  
3. Light Beige lacquer (NK) / Laccato Beige Chiaro (NK) 4. Burnt Orange lacquer (NJ) / Laccato Arancio Bruciato (NJ)  
5. Umbra Grey lacquer (LO) / Laccato Grigio Ombra (LO) 6. Whitened Elm (OB) / Olmo Sbiancato (OB)  
7. D03/375 fabric / Tessuto D03/375 8. D03 /377 fabric / Tessuto D03 /377 9. D03/363 fabric / Tessuto D03/363



# ELEGANCE COLOURS MOODBOARD

---

**Velvet, fabric and porcelain stoneware modulate sober yet precious interiors, defining the personality of sophisticated and exclusive places.**

Velluto, tessuto e gres porcellanato modulano contesti sobri ma preziosi e definiscono la personalità di luoghi sofisticati ed esclusivi.

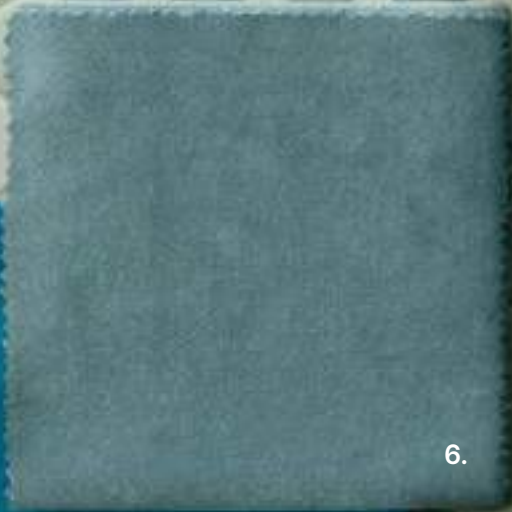



# ECLECTIC COLOURS MOODBOARD

---

**Unexpected and surprising pairings between marine, candid and earthy tonalities furnish shared and meeting interiors with original grace.**

Accostamenti inaspettati e sorprendenti tra tonalità marine, candide e di terra arredano contesti di condivisione e incontro con inedita grazia.

1. Invisible White porcelain stoneware (LIW) / Gres porcellanato Invisible White (LIW)
2. Ocean Blue lacquer (LD) / Laccato Blu Oceano (LD)
3. Matt White metal (O) / Metallo Bianco Opaco (O)
4. Eucalyptus (EC) / Eucalipto (EC)
5. D04/399 fabric / Tessuto D04/399
6. E04/491 fabric / Tessuto E04/491
7. E04/484 fabric / Tessuto E04/484
8. E04/487 fabric / Tessuto E04/487

---

**Shapes and sizes**

Abaco degli elementi

---

# Residential & Hospitality Collection

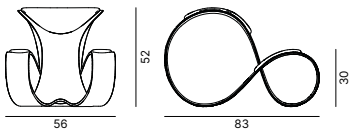

SHELL FINISH OPTIONS  
FINITURE DISPONIBILI SCOCCA

POLYMERS  
PLASTICA



PAD FINISH OPTIONS  
FINITURE DISPONIBILI PAD

FABRICS AND LEATHERS  
TESSUTI E PELLI



E01: 417/428/429/431/421/420

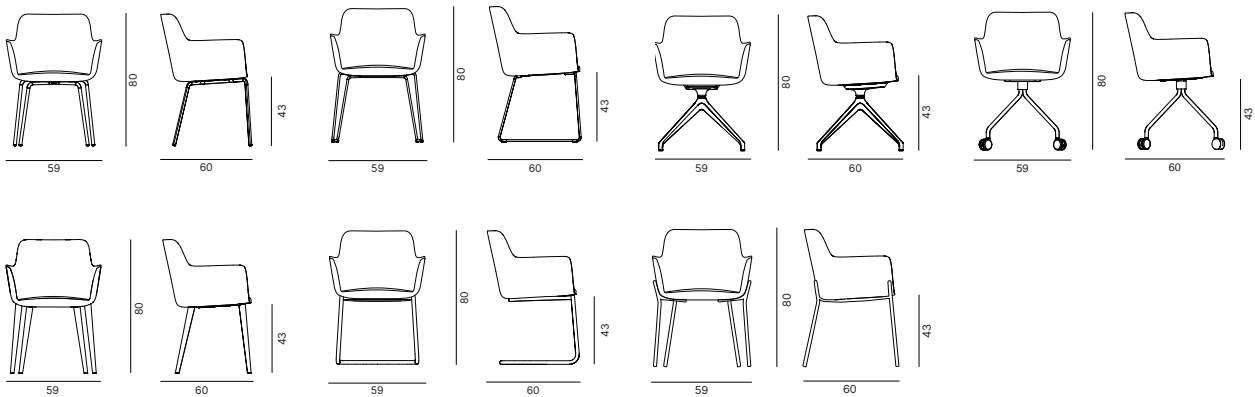

BASE FINISH OPTIONS  
FINITURE DISPONIBILI BASE

METAL  
METALLO



SOLID ASH WOOD  
FRASSINO MASSELLO



UPHOLSTERY  
RIVESTIMENTI

FABRICS AND LEATHERS  
TESSUTI E PELLI



B01-B03-C01-C05-D02-D03-D04-D05-D06-P01-E01-E02-E03-E04-I01-I02-M01-M02-M03

## Design Chairs & Soft Seating

# CITY DÉCO

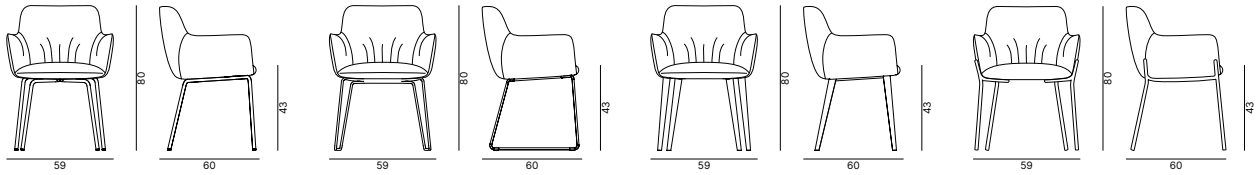

### BASE FINISH OPTIONS FINITURE DISPONIBILI BASE

#### METAL METALLO



#### SOLID ASH WOOD FRASSINO MASSELLO



### UPHOLSTERY RIVESTIMENTI

#### FABRICS AND LEATHERS TESSUTI E PELLI



D02-D03-D04-D05-E01-  
E02-E03-E04-I01

## Design Chairs & Soft Seating

# COMPASSO

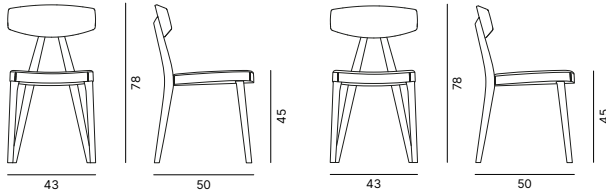

### FRAME FINISH OPTIONS FINITURE DISPONIBILI STRUTTURA

#### SOLID ASH WOOD FRASSINO MASSELLO



### BACK & SEAT FINISH OPTIONS FINITURE DISPONIBILI SEDILE E SCHIENALE

#### SOLID ASH WOOD FRASSINO MASSELLO



### SEAT FINISH OPTIONS FINITURE DISPONIBILI SEDILE

#### FABRICS AND LEATHERS TESSUTI E PELLI



B03-C05-D02-D04-D05-P01-  
E01-E02-E03-E04-I01-I02

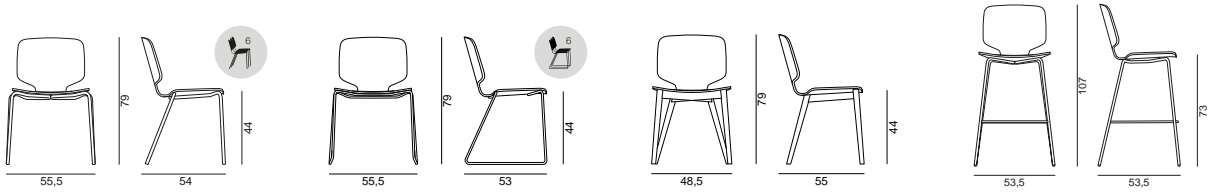

**BASE FINISH OPTIONS**  
FINITURE DISPONIBILI BASE

METAL  
METALLO



SOLID ASH WOOD  
FRASSINO MASSELLO



LACQUERED  
LACCATO



**SHELL FINISH OPTIONS**  
FINITURE DISPONIBILI SCOCCA

SOLID ASH WOOD  
FRASSINO MASSELLO



LACQUERED  
LACCATO



**SEAT FINISH OPTIONS**  
FINITURE DISPONIBILI SEDILE

FABRICS AND LEATHERS  
TESSUTI E PELLI



B01-B03-C01-C05-D02-D03-D04-D05-D06-P01-E01-E02-E03-E04-I01-I02



BASE FINISH OPTIONS  
FINITURE DISPONIBILI BASE

METAL  
METALLO



SOLID ASH WOOD  
FRASSINO MASSELLO

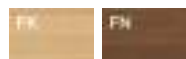

SHELL FINISH OPTIONS  
FINITURE DISPONIBILI SCOCCA

POLYMERS  
PLASTICA



FABRICS AND LEATHERS  
TESSUTI E PELLI

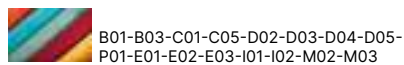

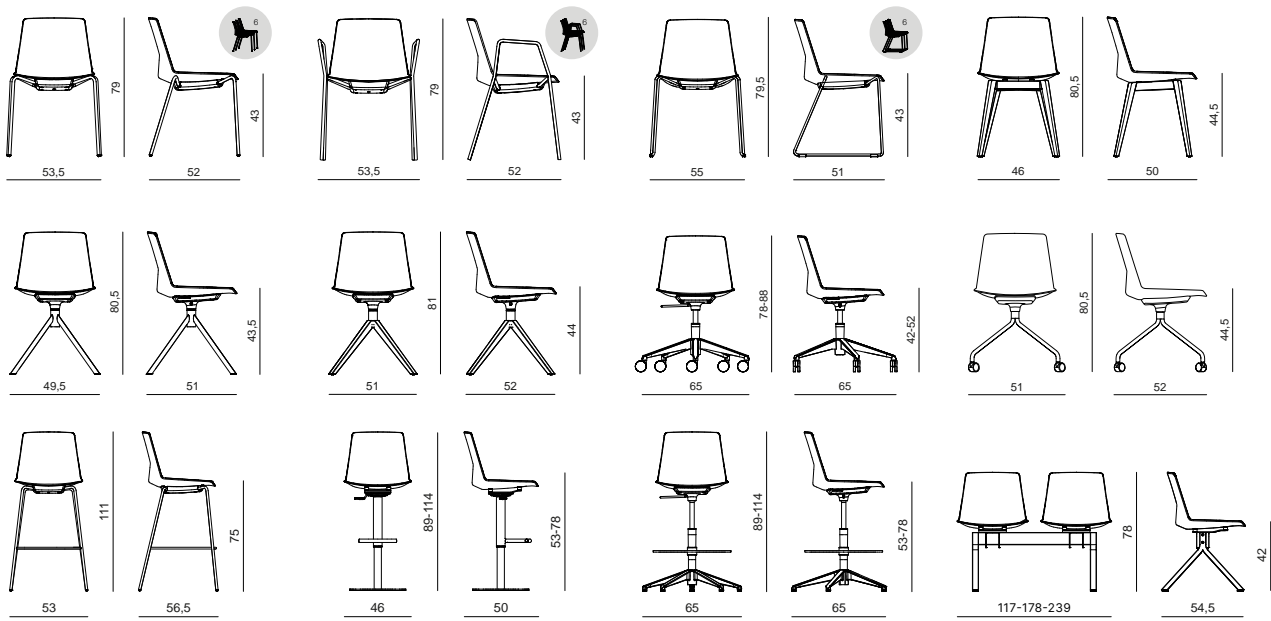

BASE FINISH OPTIONS  
FINITURE DISPONIBILI BASE

METAL  
METALLO



SOLID ASH WOOD  
FRASSINO MASSELLO



SHELL FINISH OPTIONS  
FINITURE DISPONIBILI SCOCCA

POLYMERS  
PLASTICA



FABRICS AND LEATHERS  
TESSUTI E PELLI

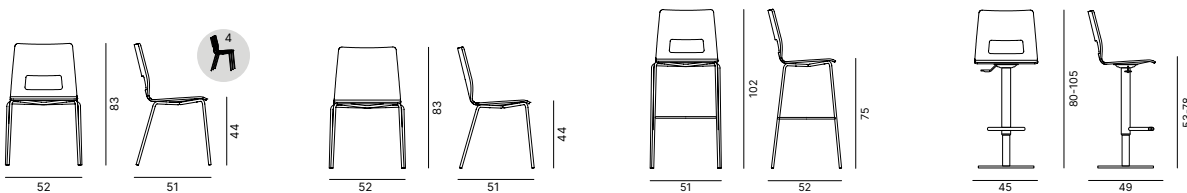
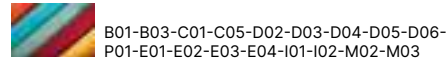

BASE FINISH OPTIONS  
FINITURE DISPONIBILI BASE

METAL  
METALLO



SHELL FINISH OPTIONS  
FINITURE DISPONIBILI SCOCCA

LACQUERED  
LACCATO



FABRICS AND LEATHERS  
TESSUTI E PELLI

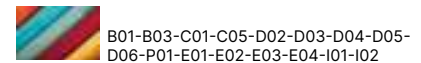

## Design Chairs & Soft Seating

# CLARK

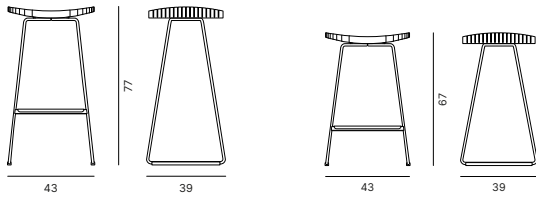

**BASE FINISH OPTIONS**  
FINITURE DISPONIBILI BASE

METAL  
METALLO

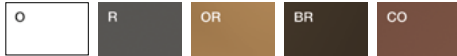

**SEAT FINISH OPTIONS**  
FINITURE DISPONIBILI SEDILE

SOLID ASH WOOD  
FRASSINO MASSELLO



## Design Chairs & Soft Seating

# C-STOOL

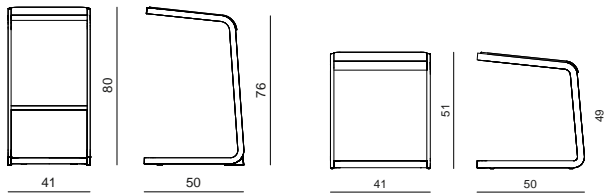

**BASE FINISH OPTIONS**  
FINITURE DISPONIBILI BASE

METAL  
METALLO

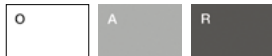

**SEAT FINISH OPTIONS**  
FINITURE DISPONIBILI SEDILE

FABRICS AND LEATHERS  
TESSUTI E PELLI

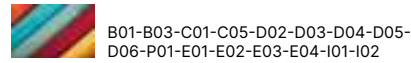

## Design Chairs & Soft Seating

# CELL

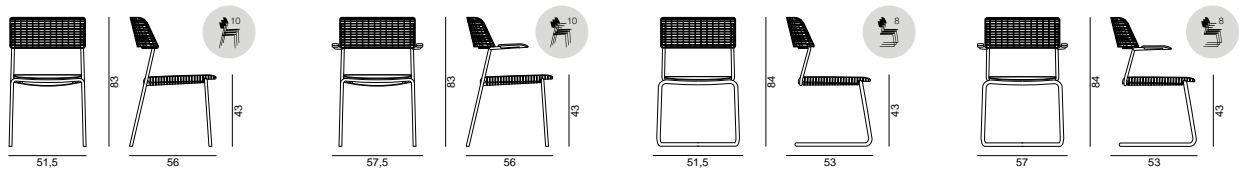

**BASE FINISH OPTIONS**  
FINITURE DISPONIBILI BASE

METAL  
METALLO



**SEAT AND BACK FINISH OPTIONS**  
FINITURE DISPONIBILI SEDILE E SCHIENALE

POLYMERS  
PLASTICHE





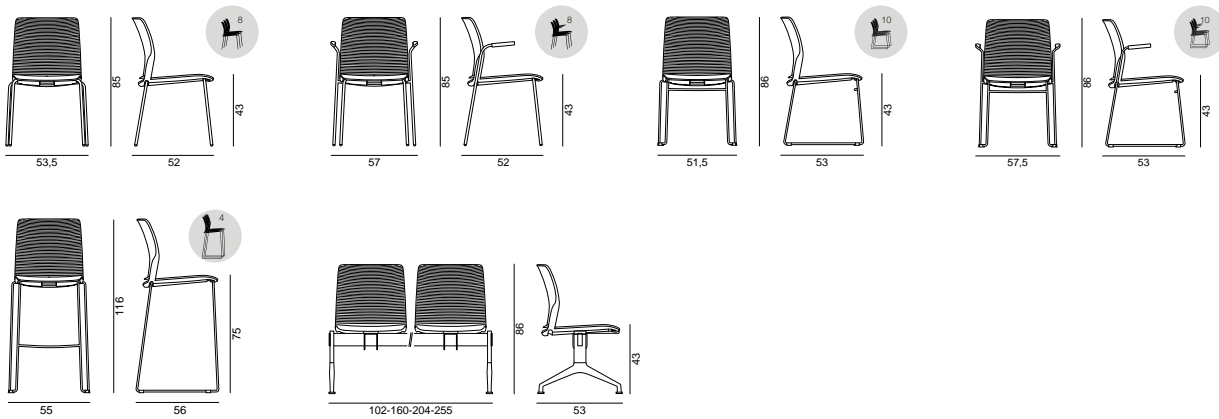

BASE FINISH OPTIONS  
FINITURE DISPONIBILI BASE

METAL  
METALLO

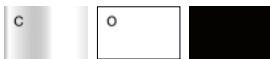

SHELL FINISH OPTIONS  
FINITURE DISPONIBILI SCOCCA

POLYMERS  
PLASTICHE



SEAT FINISH OPTIONS  
FINITURE DISPONIBILI SEDILE

FABRICS AND LEATHERS  
TESSUTI E PELLI

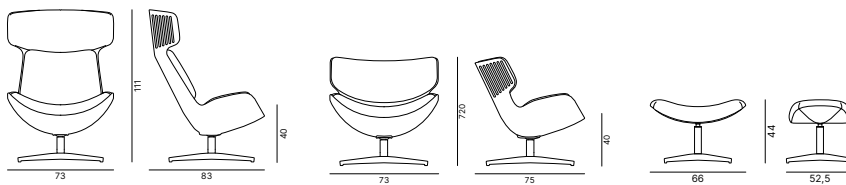

BASE FINISH OPTIONS  
FINITURE DISPONIBILI BASE

METAL  
METALLO

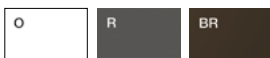

SHELL FINISH OPTIONS  
FINITURE DISPONIBILI SCOCCA

POLYMERS  
PLASTICHE

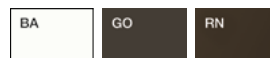

FABRICS AND LEATHERS  
TESSUTI E PELLI

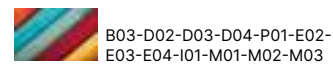

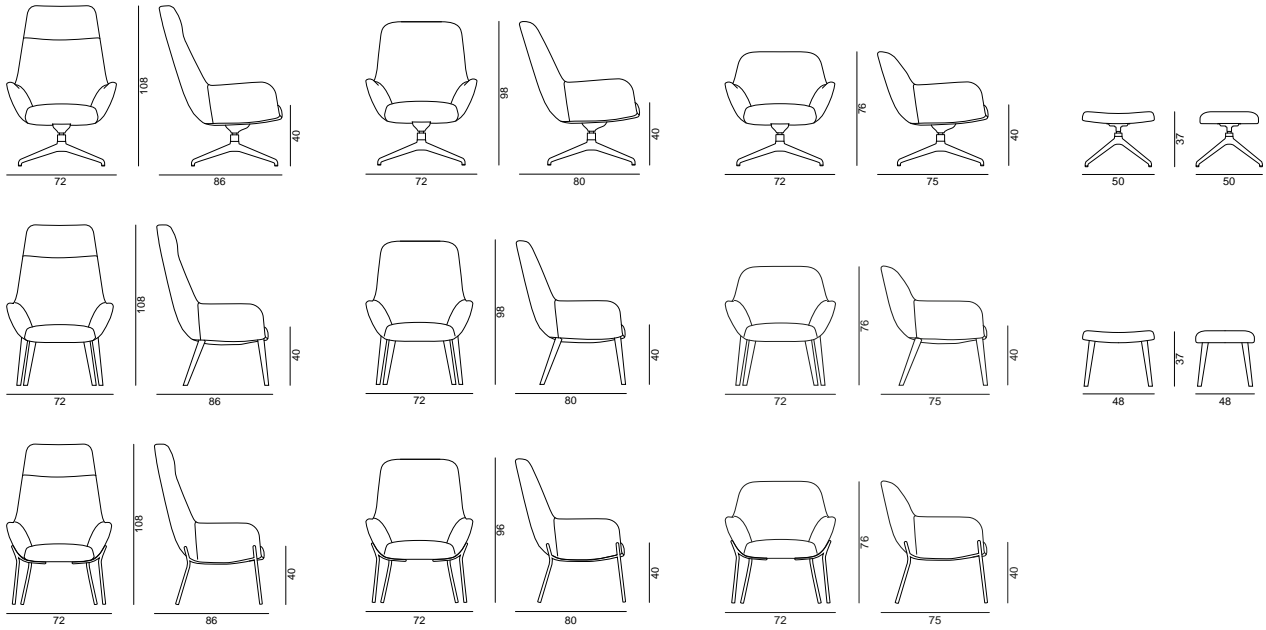

BASE FINISH OPTIONS  
FINITURE DISPONIBILI BASE

METAL  
METALLO



SOLID ASH WOOD  
FRASSINO MASSELLO



UPHOLSTERY  
RIVESTIMENTI

FABRICS AND LEATHERS  
TESSUTI E PELLI

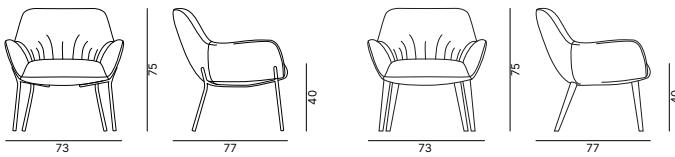
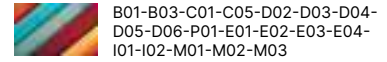

BASE FINISH OPTIONS  
FINITURE DISPONIBILI BASE

METAL  
METALLO



SOLID ASH WOOD  
FRASSINO MASSELLO



UPHOLSTERY  
RIVESTIMENTI

FABRICS AND LEATHERS  
TESSUTI E PELLI

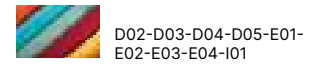

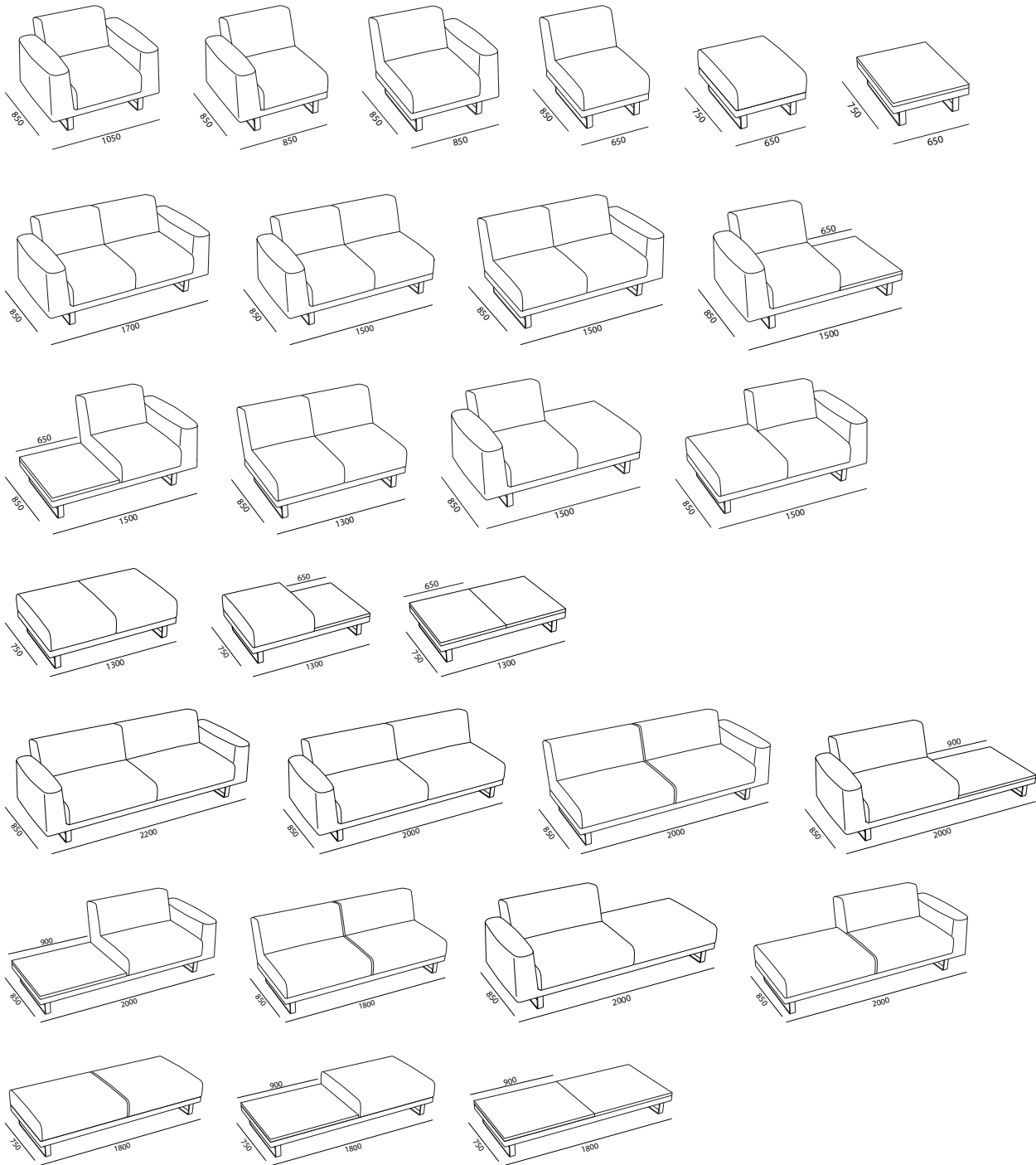

**BASE FINISH OPTIONS**  
FINITURE DISPONIBILI BASE

METAL  
METALLO



**UPHOLSTERY**  
RIVESTIMENTI

FABRICS AND LEATHERS  
TESSUTI E PELLI



B01-B03-C01-C05-D02-D03-D04-D05-D06-P01-  
E01-E02-E03-E04-I01-I02-M01-M02-M03

## Design Chairs & Soft Seating

ARCO

Residential & Hospitality Collection

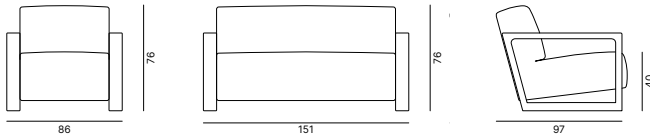

### BASE FINISH OPTIONS FINITURE DISPONIBILI BASE

SOLID ASH WOOD  
FRASSINO MASSELLO



### UPHOLSTERY RIVESTIMENTI

FABRICS AND LEATHERS  
TESSUTI E PELLI



B01-B03-C01-C05-D02-D03-D04-D05-D06-P01-  
E01-E02-E03-E04-I01-I02-M01-M02-M03

## Design Chairs & Soft Seating

ARTE

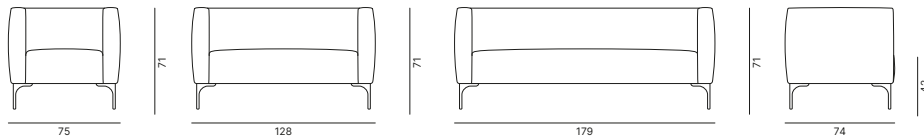

466

### LEGS FINISH OPTIONS FINITURE DISPONIBILI PIEDINI

METAL  
METALLO



### UPHOLSTERY RIVESTIMENTI

FABRICS AND LEATHERS  
TESSUTI E PELLI



B01-B03-C01-C05-D02-D03-D04-D05-D06-P01-  
E01-E02-E03-E04-I01-I02-M01-M02-M03

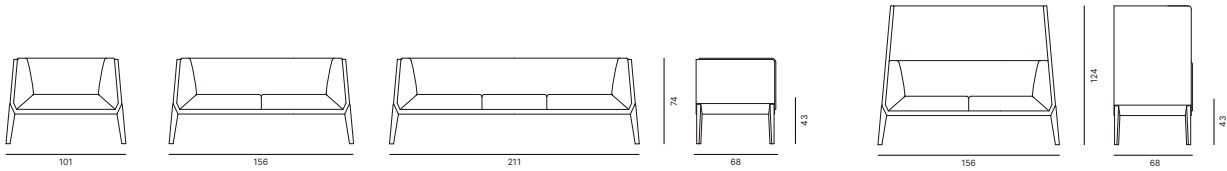

BASE FINISH OPTIONS  
FINITURE DISPONIBILI BASE

METAL  
METALLO

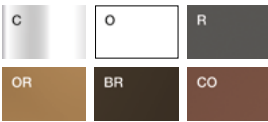

SOLID ASH WOOD  
FRASSINO MASSELLO



UPHOLSTERY  
RIVESTIMENTI

FABRICS AND LEATHERS  
TESSUTI E PELLI



B01-B03-C01-C05-D02-D03-D04-D05-D06-P01-  
E01-E02-E03-E04-I01-I02-M01-M02-M03

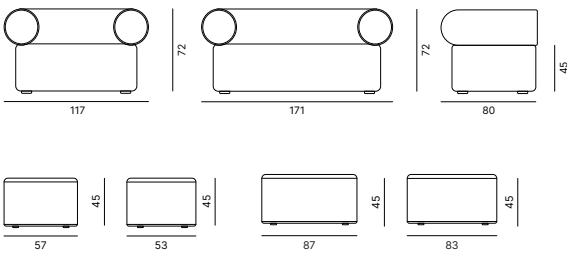

LEGS FINISH OPTIONS  
FINITURE DISPONIBILI PIEDINI

SOLID BEECH WOOD  
FAGGIO MASSELLO



UPHOLSTERY  
RIVESTIMENTI

FABRICS AND LEATHERS  
TESSUTI E PELLI



B01-B03-C01-C05-D02-D03-D04-D05-D06-P01-  
E01-E02-E03-E04-I01-I02-M01-M02-M03

## Design Chairs & Soft Seating

ADO

Residential & Hospitality Collection

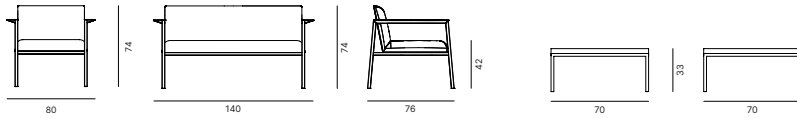

### BASE FINISH OPTIONS FINITURE DISPONIBILI BASE

#### METAL METALLO

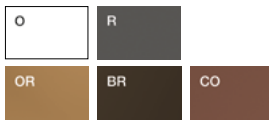

### ARMS FINISH OPTIONS FINITURE DISPONIBILI BRACCIOLI

#### SOLID ASH WOOD FRASSINO MASSELLO



### UPHOLSTERY RIVESTIMENTI

#### FABRICS AND LEATHERS TESSUTI E PELLI



B01-B03-C01-C05-D02-D03-D04-D05-D06-P01-E01-E02-E03-E04-I01-I02-M01-M02-M03

## Design Chairs & Soft Seating

ASTRO

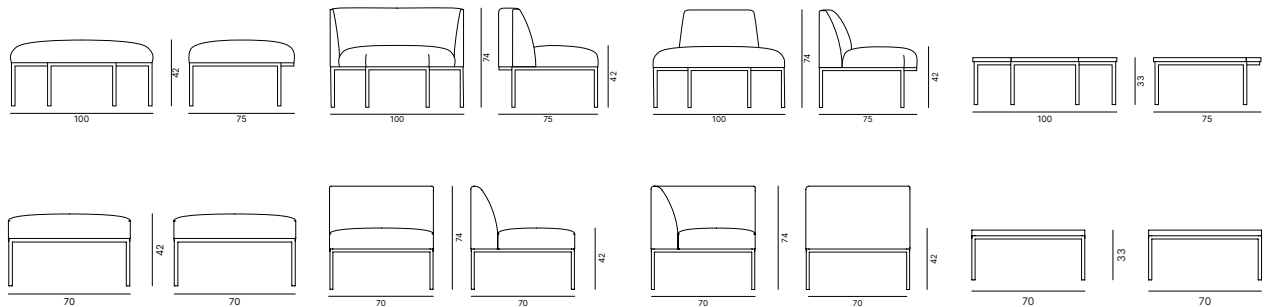

### BASE FINISH OPTIONS FINITURE DISPONIBILI BASE

#### METAL METALLO



### UPHOLSTERY RIVESTIMENTI

#### FABRICS AND LEATHERS TESSUTI E PELLI



B01-B03-C01-C05-D02-D03-D04-D05-D06-P01-E01-E02-E03-E04-I01-I02-M01-M02-M03

## Design Chairs & Soft Seating

# ARMONY

DESIGN LIVING

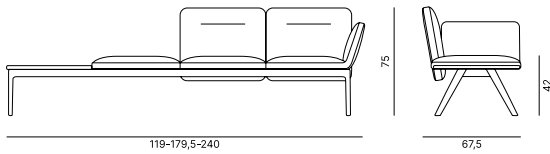

### BASE FINISH OPTIONS FINITURE DISPONIBILI BASE

METAL  
METALLO



### UPHOLSTERY RIVESTIMENTI

FABRICS AND LEATHERS  
TESSUTI E PELLI



B01-B03-C05-D02-D03-D04-D05-D06-P01-  
E01-E02-E03-E04-I01-I02-M01-M02-M03

## Design Chairs & Soft Seating

# AGIO

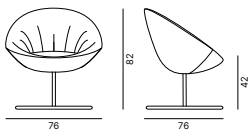

### BASE FINISH OPTIONS FINITURE DISPONIBILI BASE

METAL  
METALLO



### UPHOLSTERY RIVESTIMENTI

FABRICS AND LEATHERS  
TESSUTI E PELLI



B01-B03-C01-C05-D02-D03-D04-D05-P01-  
E01-E02-E03-E04-I01-I02-M01-M02-M03

## Design Chairs & Soft Seating

# ALIAS

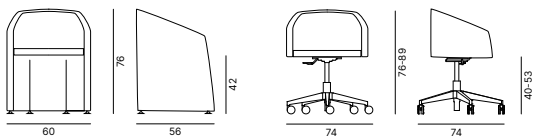

### BASE FINISH OPTIONS FINITURE DISPONIBILI BASE

METAL  
METALLO



NYLON  
NYLON



### UPHOLSTERY RIVESTIMENTI

FABRICS AND LEATHERS  
TESSUTI E PELLI



B01-B03-C01-C05-D02-D03-D04-D05-D06-  
P01-E01-E02-E03

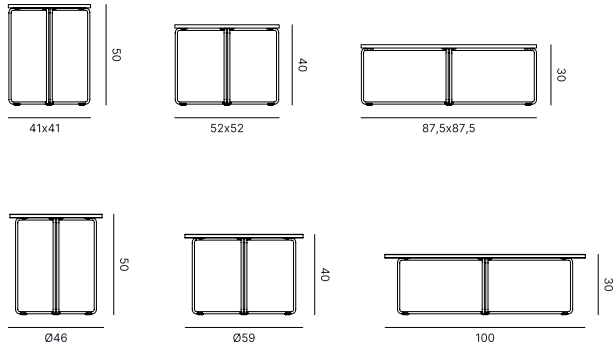

TOP FINISH OPTIONS  
FINITURE DISPONIBILI PIANI

PORCELAIN STONWARE  
GRES PORCELLANATO



MELAMINE  
MELAMINICO



MATT LACQUER  
LACCATO OPACO



FRAME FINISH OPTIONS  
FINITURE DISPONIBILI STRUTTURA

METAL  
METALLO

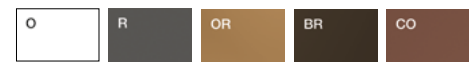

DECORATIVE EDGES FINISH OPTIONS  
FINITURE DISPONIBILI BORDI DECORATIVI

METAL  
METALLO

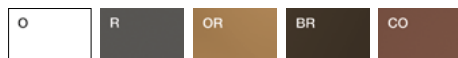



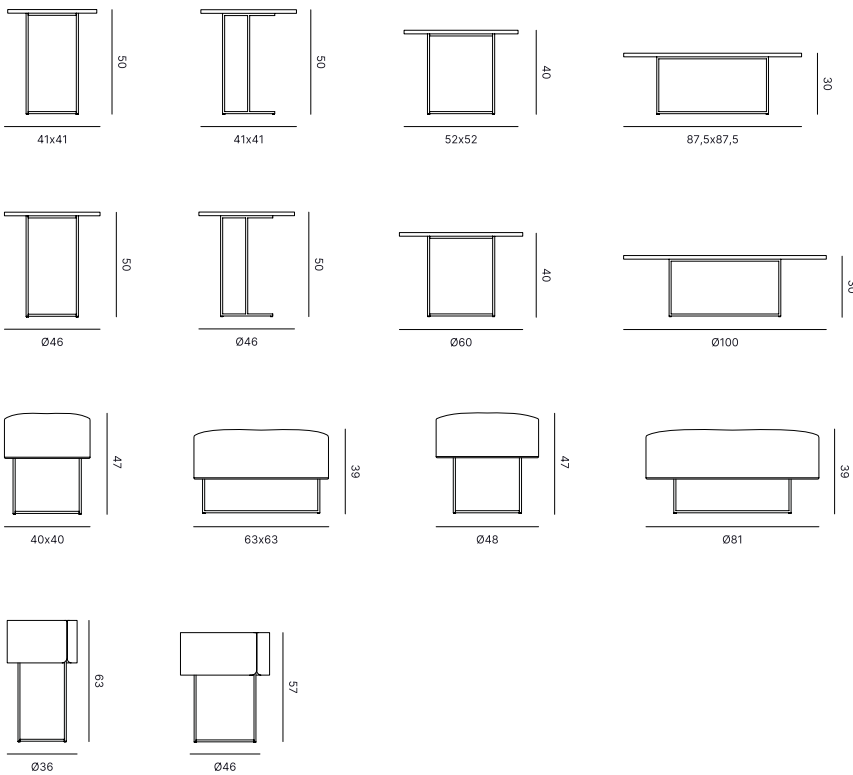

TOP FINISH OPTIONS  
FINITURE DISPONIBILI PIANI

PORCELAIN STONEWARE  
GRES PORCELLANATO



MELAMINE  
MELAMINICO



MATT LACQUER  
LACCATO OPACO



FRAME FINISH OPTIONS  
FINITURE DISPONIBILI STRUTTURA

METAL  
METALLO

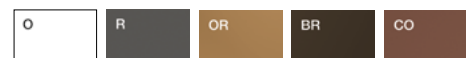

DECORATIVE EDGES FINISH OPTIONS  
FINITURE DISPONIBILI BORDI DECORATIVI

METAL  
METALLO



POUF UPHOLSTERY  
RIVESTIMENTI POUF

FABRICS AND LEATHERS  
TESSUTI E PELLI

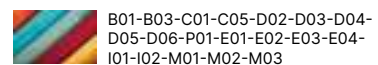

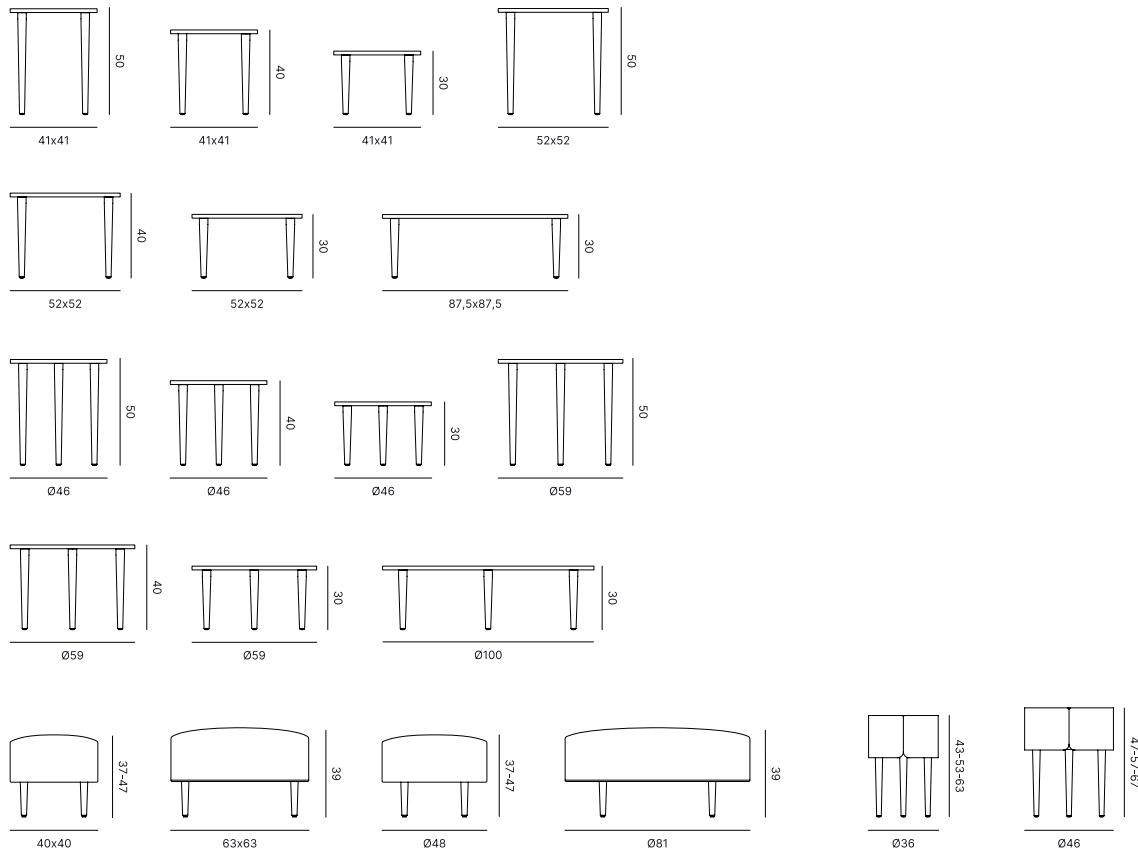

TOP FINISH OPTIONS  
FINITURE DISPONIBILI PIANI

PORCELAIN STONEWARE  
GRES PORCELLANATO



MELAMINE  
MELAMINICO



MATT LACQUER  
LACCATO OPACO



FRAME FINISH OPTIONS  
FINITURE DISPONIBILI STRUTTURA

SOLID ASH WOOD  
FRASSINO MASSELLO

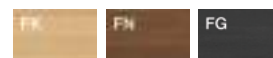

472

DECORATIVE EDGES FINISH OPTIONS  
FINITURE DISPONIBILI BORDI DECORATIVI

METAL  
METALLO

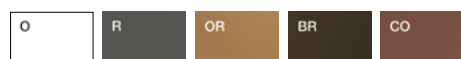

POUF UPHOLSTERY  
RIVESTIMENTI POUF

FABRICS AND LEATHERS  
TESSUTI E PELLI

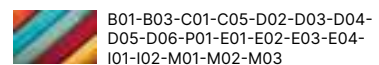

B01-B03-C01-C05-D02-D03-D04-D05-D06-P01-E01-E02-E03-E04-I01-I02-M01-M02-M03

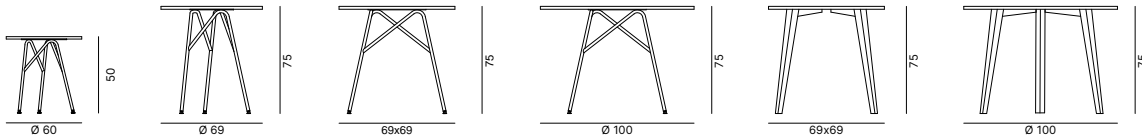

BASE FINISH OPTIONS  
FINITURE DISPONIBILI BASE

METAL  
METALLO



SOLID ASH WOOD  
FRASSINO MASSELLO



TOP FINISH OPTIONS  
FINITURE DISPONIBILI PIANI

MELAMINE  
MELAMINICO



HPL  
HPL



MATT LACQUER  
LACCATO OPACO

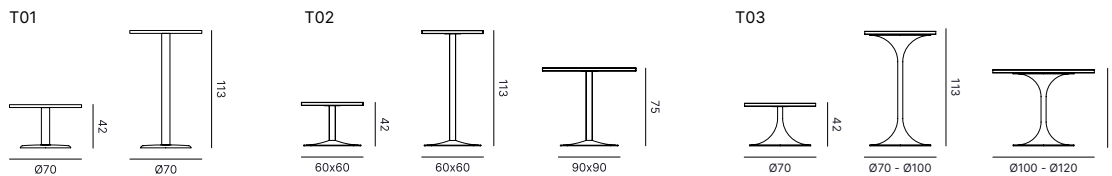

FRAME FINISH OPTIONS  
FINITURE DISPONIBILI STRUTTURA

METAL  
METALLO



TOP FINISH OPTIONS  
FINITURE DISPONIBILI PIANI

MELAMINE  
MELAMINICO



MATT LACQUER  
LACCATO OPACO



Accessories & Side Tables

T05

Residential & Hospitality Collection

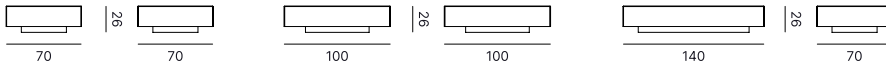

FRAME FINISH OPTIONS  
FINITURE DISPONIBILI STRUTTURA

MELAMINE  
MELAMINICO



TOP FINISH OPTIONS  
FINITURE DISPONIBILI PIANI

MELAMINE  
MELAMINICO

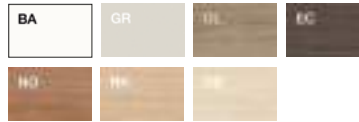

MATT LACQUER  
LACCATO OPACO



Accessories & Side Tables

T06

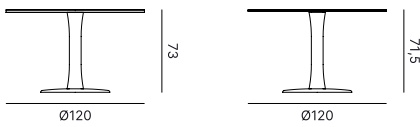

FRAME FINISH OPTIONS  
FINITURE DISPONIBILI STRUTTURA

METAL  
METALLO



TOP FINISH OPTIONS  
FINITURE DISPONIBILI PIANI

MELAMINE  
MELAMINICO



MATT LACQUER  
LACCATO OPACO



GLASS  
VETRO



474

Accessories & Side Tables

FLIPPER

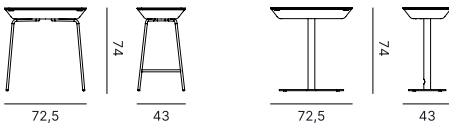

FRAME FINISH OPTIONS  
FINITURE DISPONIBILI STRUTTURA

TOP FINISH OPTIONS  
FINITURE DISPONIBILI PIANI

METAL  
METALLO

MELAMINE  
MELAMINICO



Accessories & Side Tables

PETAL & CLOAK

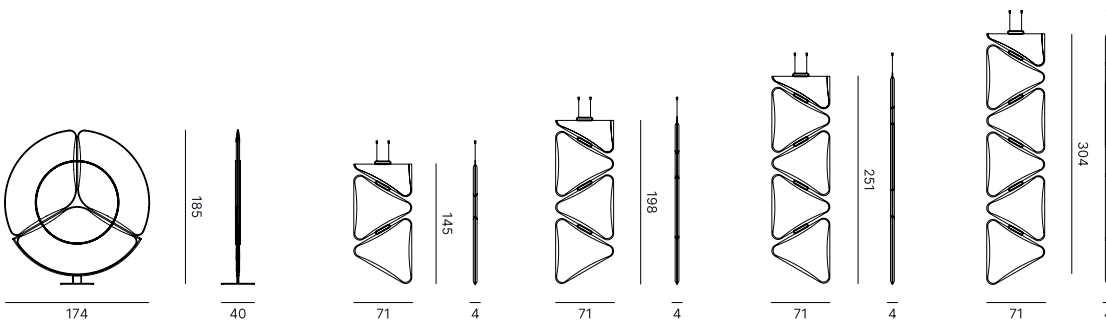

FRAME FINISH OPTIONS  
FINITURE DISPONIBILI STRUTTURA

PANELS FINISH OPTIONS  
FINITURE DISPONIBILI PANNELLI

METAL  
METALLO

FABRICS  
TESSUTO



Accessories & Side Tables

ALTER EGO

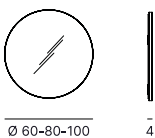

FRAME FINISH OPTIONS  
FINITURE DISPONIBILI TELAIO PERIMETRALE

METAL  
METALLO



# Living Tables

# NINE

Residential & Hospitality Collection

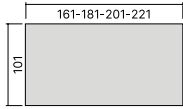

### FRAME FINISH OPTIONS FINITURE DISPONIBILI STRUTTURA

METAL  
METALLO



### TOPS FINISH OPTIONS FINITURE DISPONIBILI PIANI

WOOD VENEER  
LEGNO IMPIALLACCIATO



# Living Tables

# EIGHT

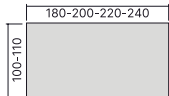

### FRAME FINISH OPTIONS FINITURE DISPONIBILI STRUTTURA

METAL  
METALLO



### TOPS FINISH OPTIONS FINITURE DISPONIBILI PIANI

MELAMINE  
MELAMINICO



MATT LACQUER  
LACCATO OPACO



GLASS  
VETRO



PORCELAIN STONEWARE  
GRES PORCELLANATO

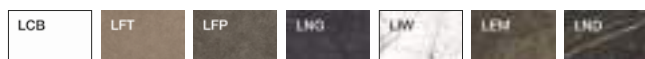

476

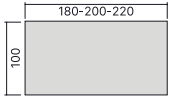

FRAME FINISH OPTIONS  
FINITURE DISPONIBILI STRUTTURA

METAL  
METALLO

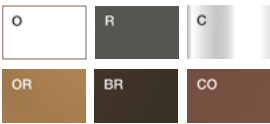

TOPS FINISH OPTIONS  
FINITURE DISPONIBILI PIANI

MELAMINE  
MELAMINICO



MATT LACQUER  
LACCATO OPACO



GLASS  
VETRO



PORCELAIN STONEWARE  
GRES PORCELLANATO

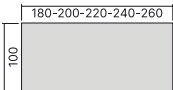

FRAME FINISH OPTIONS  
FINITURE DISPONIBILI STRUTTURA

METAL  
METALLO



TOPS FINISH OPTIONS  
FINITURE DISPONIBILI PIANI

PORCELAIN STONEWARE  
GRES PORCELLANATO



METAL  
METALLO

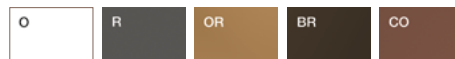

# Living Tables

# FIVE

Residential & Hospitality Collection

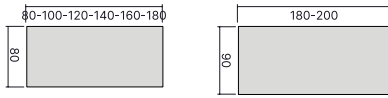

FRAME FINISH OPTIONS  
FINITURE DISPONIBILI STRUTTURA

TOPS FINISH OPTIONS  
FINITURE DISPONIBILI PIANI

METAL  
METALLO

MELAMINE  
MELAMINICO

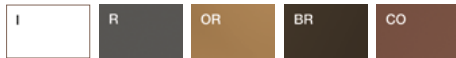

# Living Tables

# THREE

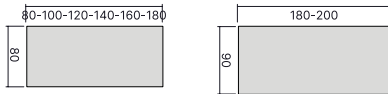

FRAME FINISH OPTIONS  
FINITURE DISPONIBILI STRUTTURA

TOPS FINISH OPTIONS  
FINITURE DISPONIBILI PIANI

METAL  
METALLO

MELAMINE  
MELAMINICO

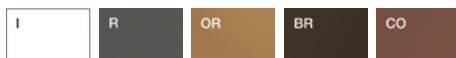

WOOD  
LEGNO



478



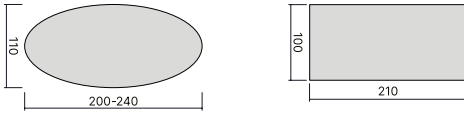

FRAME FINISH OPTIONS  
FINITURE DISPONIBILI STRUTTURA

METAL  
METALLO

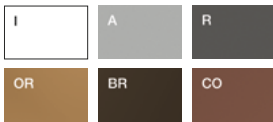

TOPS FINISH OPTIONS  
FINITURE DISPONIBILI PIANI

PORCELAIN STONEWARE  
GRES PORCELLANATO



CREO

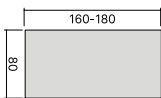

GREKO

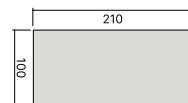

FRAME FINISH OPTIONS  
FINITURE DISPONIBILI STRUTTURA

METAL  
METALLO

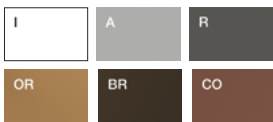

TOPS FINISH OPTIONS  
FINITURE DISPONIBILI PIANI

MELAMINE  
MELAMINICO



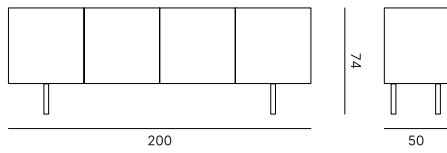
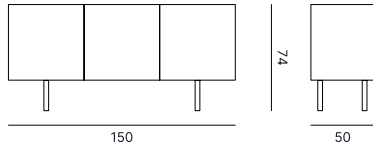

LEGS FINISH OPTIONS  
FINITURE DISPONIBILI PIEDINI

METAL  
METALLO

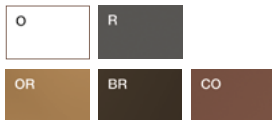

SOLID ASH WOOD  
FRASSINO MASSELLO



TOP, SIDES AND DOORS FINISH OPTIONS  
FINITURE DISPONIBILI TOP, FIANCHI E ANTE

PORCELAIN STONEWARE  
GRES PORCELLANATO



WOOD VENEER  
LEGNO IMPIALLACCIATO



MATT LACQUER  
LACCATO OPACO



480

BACK FINISH OPTIONS  
FINITURE DISPONIBILI SCHIENA

MELAMINE  
MELAMINICO



MATT LACQUER  
LACCATO OPACO



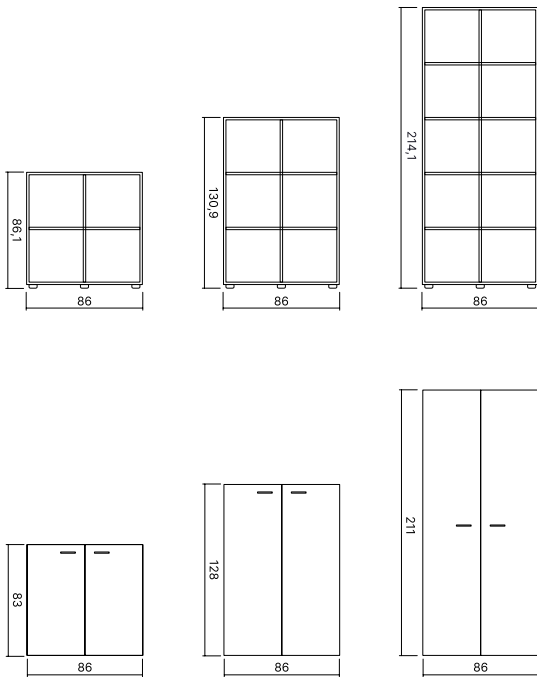

CARCASS FINISH OPTIONS  
FINITURE DISPONIBILI SCOCCA

MELAMINE  
MELAMINICO



LACQUERED  
LACCATO



DOORS, SIDES AND TOP FINISH OPTIONS  
FINITURE DISPONIBILI ANTE, FIANCHI E TOP

MELAMINE  
MELAMINICO



WOOD VENEER  
LEGNO IMPIALLACCIATO



LEATHER  
CUOINETTO



MATT LACQUER  
LACCATO OPACO



Residential & Hospitality Collection

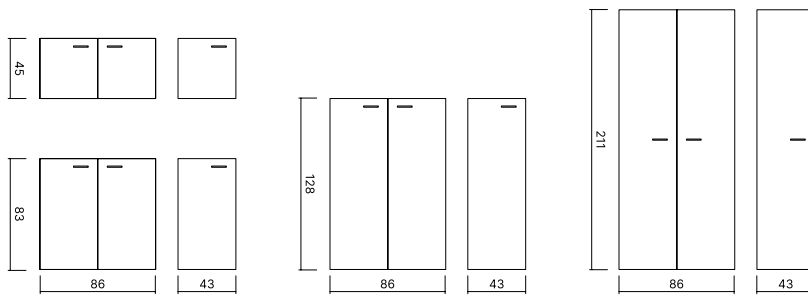
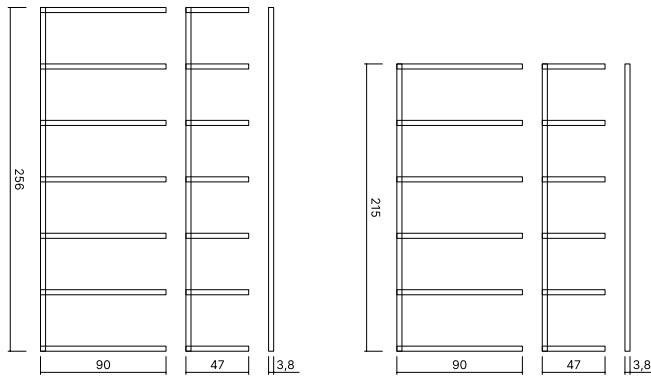

STRUCTURE FINISH OPTIONS  
FINITURE STRUTTURA

MELAMINE  
MELAMINICO



MATT LACQUER  
LACCATO OPACO



DOORS FINISH OPTIONS  
FINITURE DISPONIBILI ANTE

MELAMINE  
MELAMINICO



MATT LACQUER  
LACCATO OPACO



LEATHER  
CUOINETTO



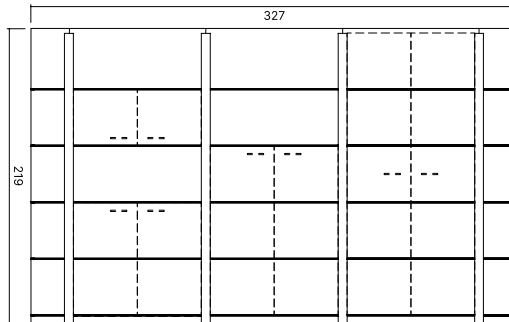
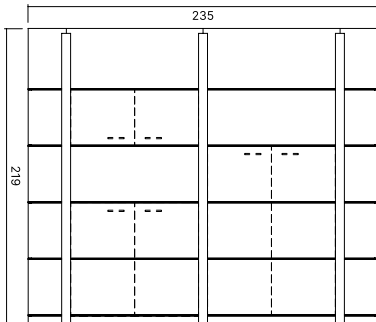
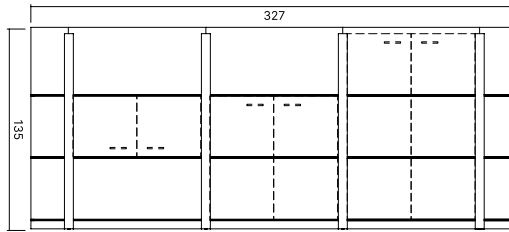
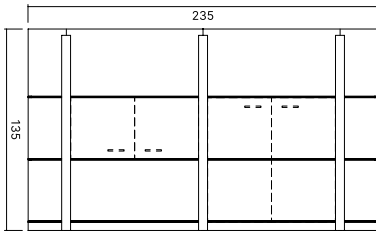

BACK AND SIDE PANEL FINISH OPTIONS  
FINITURE SCHIENA E FIANCHI

MELAMINE  
MELAMINICO



LACQUERED  
LACCATO



DOORS FINISH OPTIONS  
FINITURE DISPONIBILI ANTE

MELAMINE  
MELAMINICO



LACQUERED  
LACCATO



LEATHER  
CUOINETTO



UPRIGHTS FINISH OPTIONS  
FINITURE DISPONIBILI MONTANTI

METAL  
METALLO



SHELVES FINISH OPTIONS  
FINITURE DISPONIBILI MENSOLE

GLASS  
VETRO



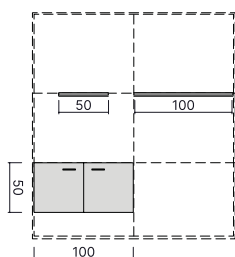
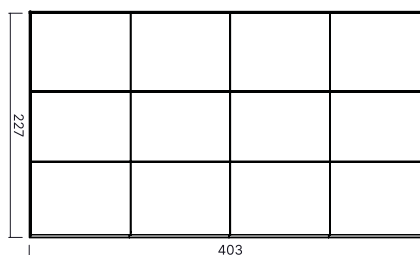
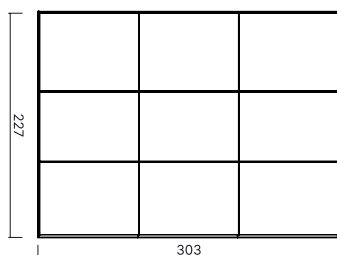
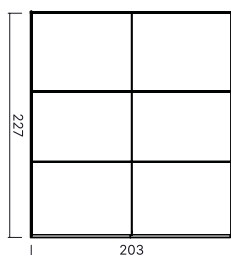

SOLID PANELS FINISH OPTIONS  
FINITURE PANNELLI

MELAMINE  
MELAMINICO



WOOD VENEER  
LEGNO IMPIALLACCIATO



LACQUERED  
LACCATO



TRACKS FINISH OPTIONS  
FINITURE PROFILI

METAL  
METALLO



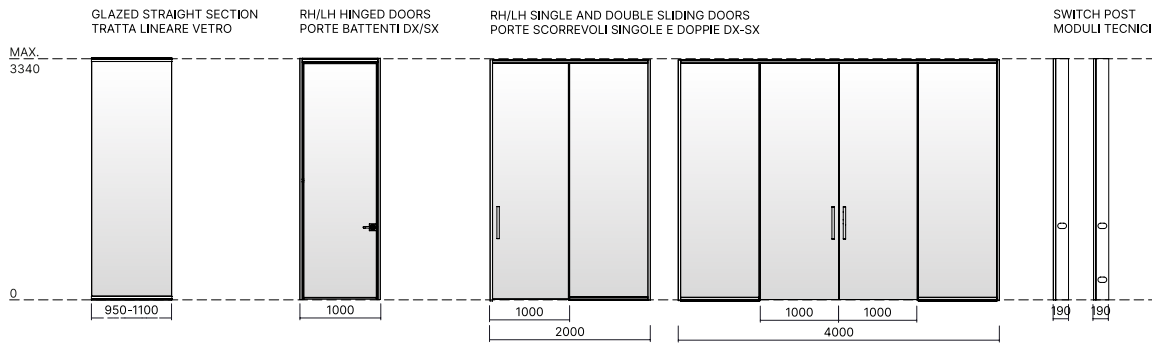

DESIGN LIVING

TRACKS FINISH OPTIONS  
FINITURE PROFILI

METAL  
METALLO



WOOD VENEER (\*)  
LEGNO IMPIALLACCIATO (\*)



(\*) Not available for sliding doors/  
Non disponibile per le porte scorrevoli

GLAZED PANELS AND DOORS FINISH OPTIONS  
FINITURE MODULI E PORTE VETRO

GLASS  
VETRO



GLASS FINISH FILM  
PELLICOLE DECORATIVE



---

**Finishes and materials**

Materiali e finiture

---

# Residential & Hospitality Collection



B01

On stock

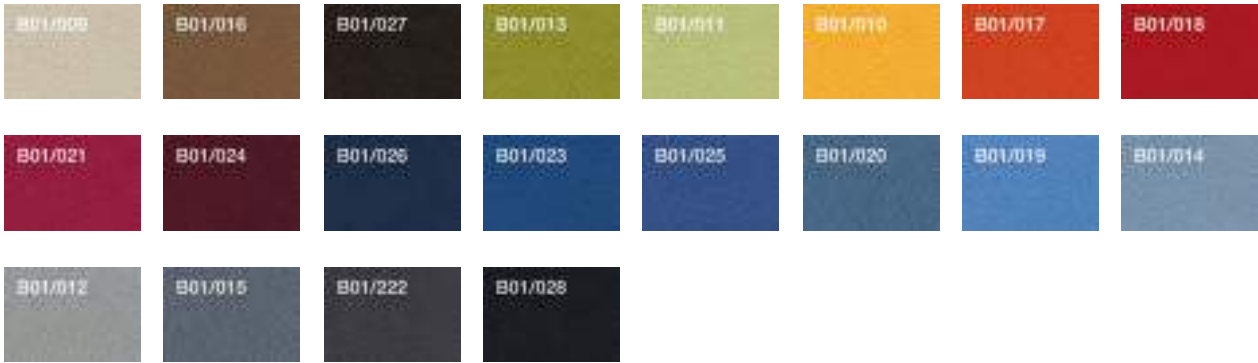

DESIGN LIVING

B03

On stock

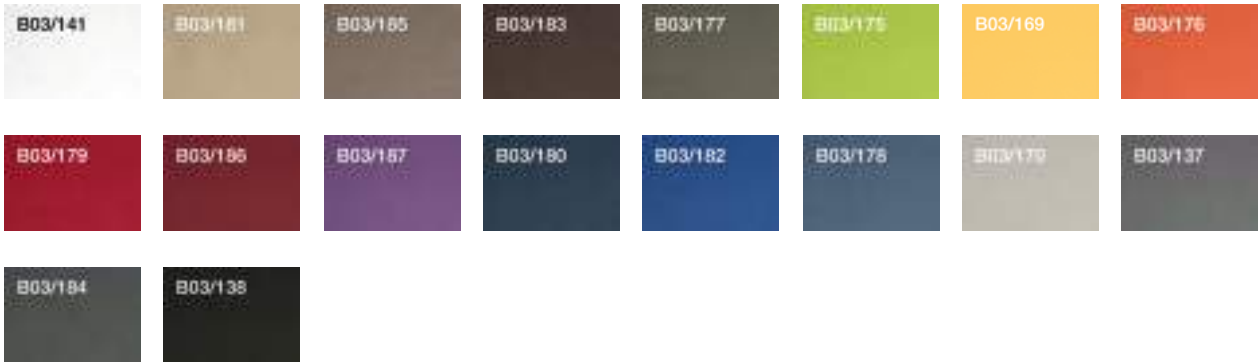

C01

On stock

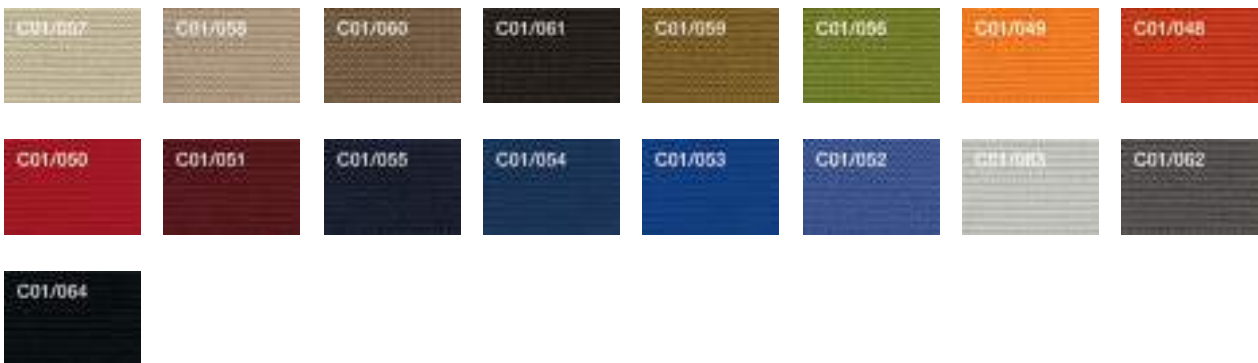

C05

On stock



D02

On stock



D03

On stock

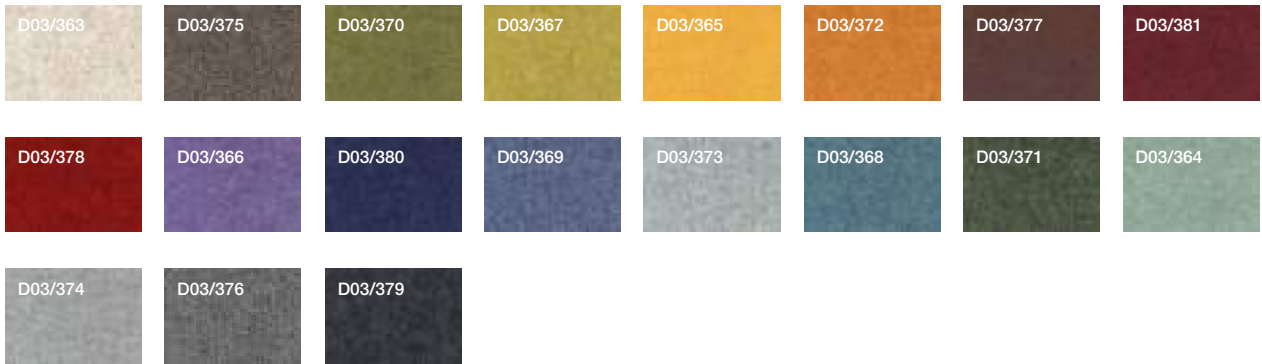

# D04

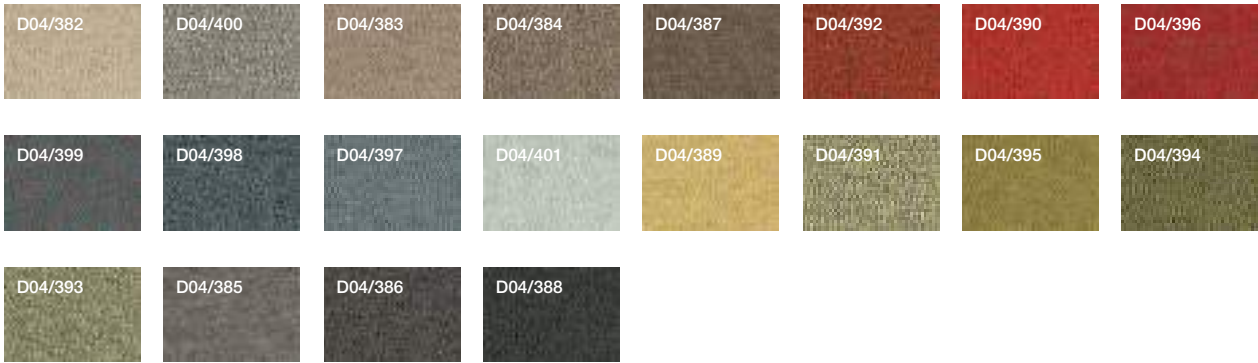

DESIGN LIVING

# D05

On stock



# D06

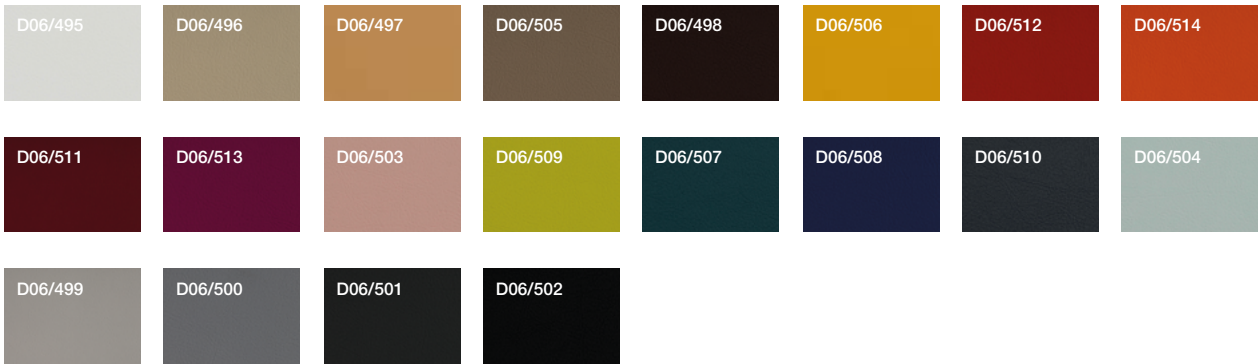

P01

On stock



E01

On stock

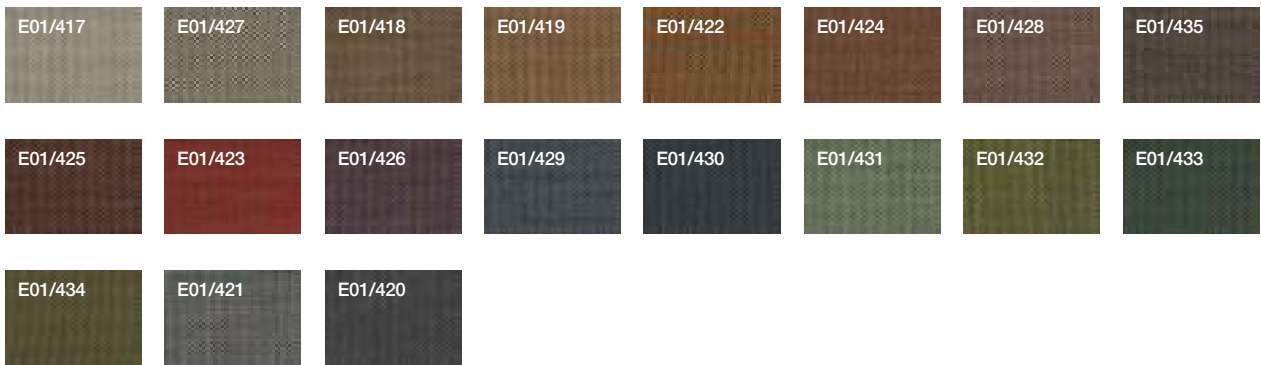

E02



## E03



DESIGN LIVING

## E04

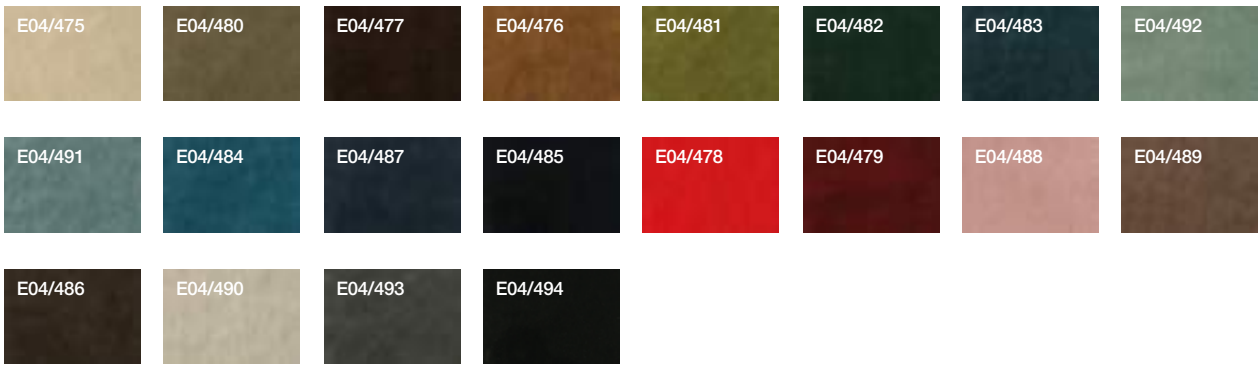

## I01

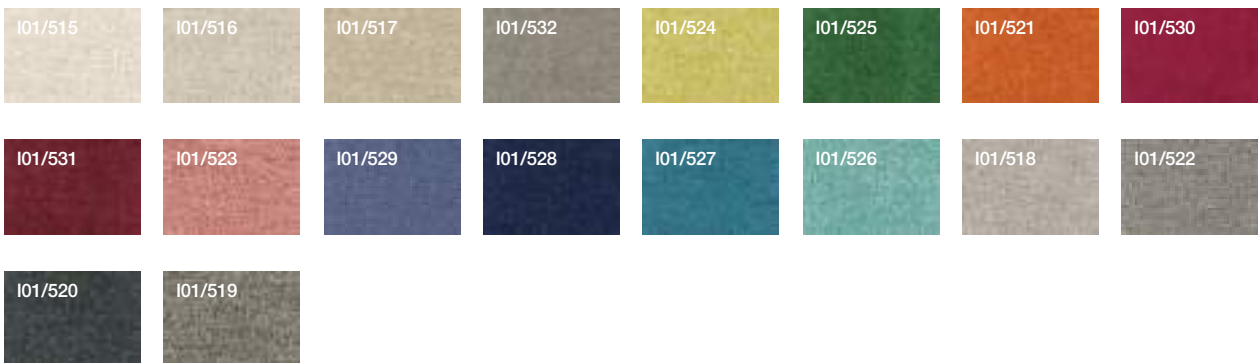

# I02



# M01

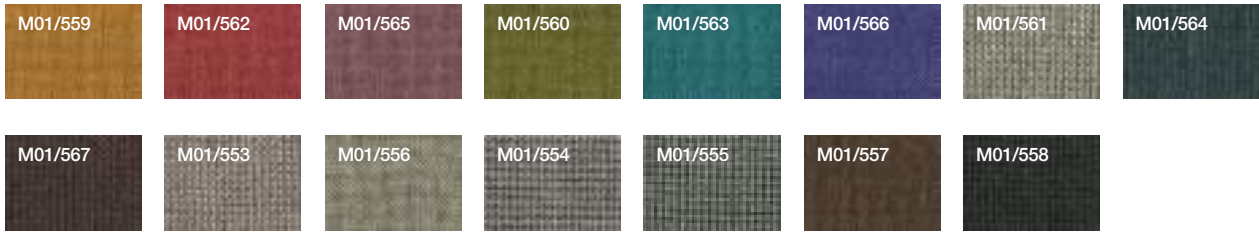

# M02

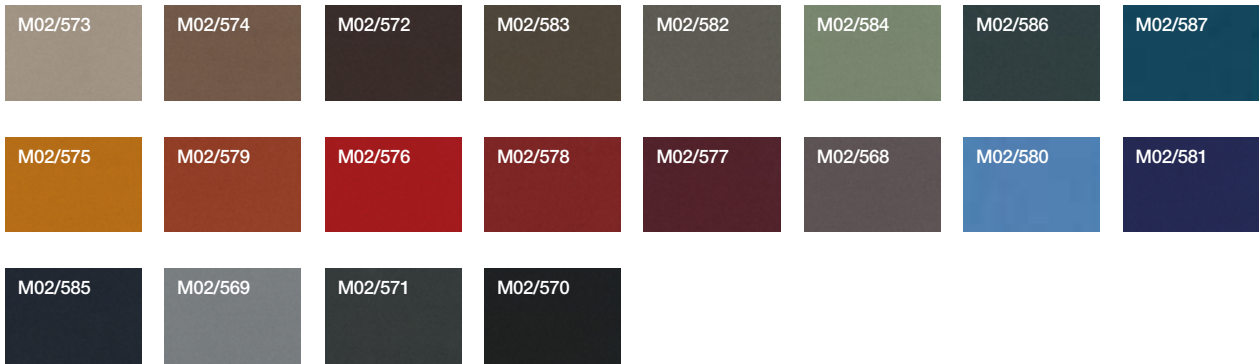

# M03

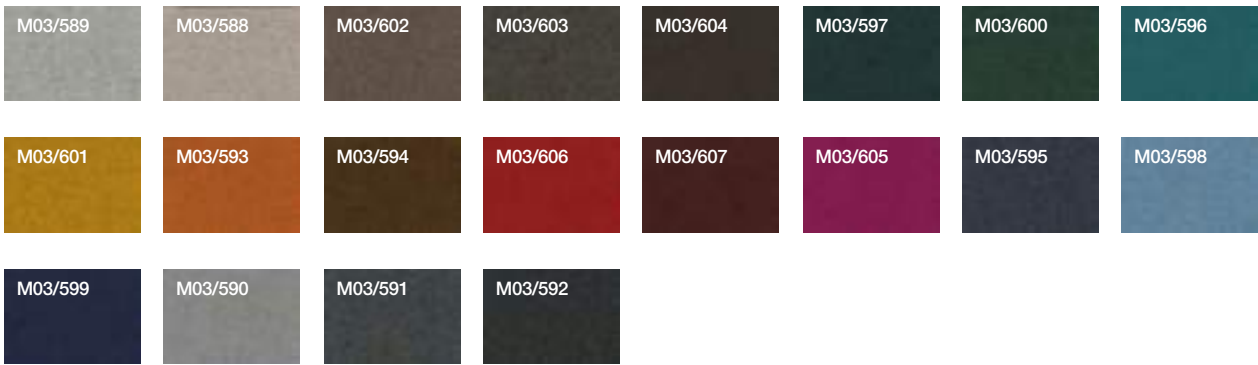

DESIGN LIVING

# Polymers

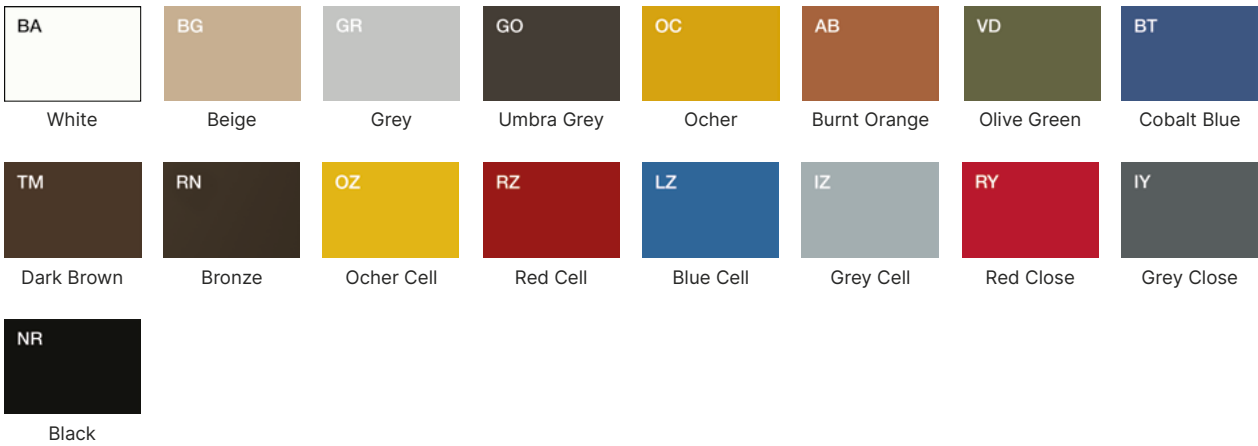

# Metal

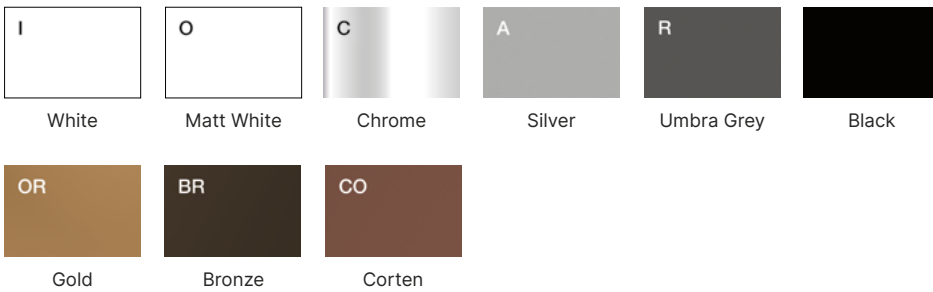

## Solid ash wood



## Porcelain stoneware



Production lead time: 5 weeks exclusive of delivery time.

## Wood veneer

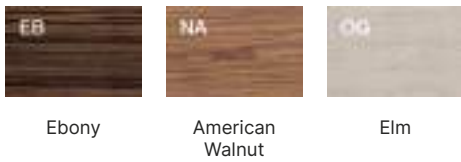

## Leather



## Matt lacquer



Production lead time: 5 weeks exclusive of delivery time.



# Melamine

---

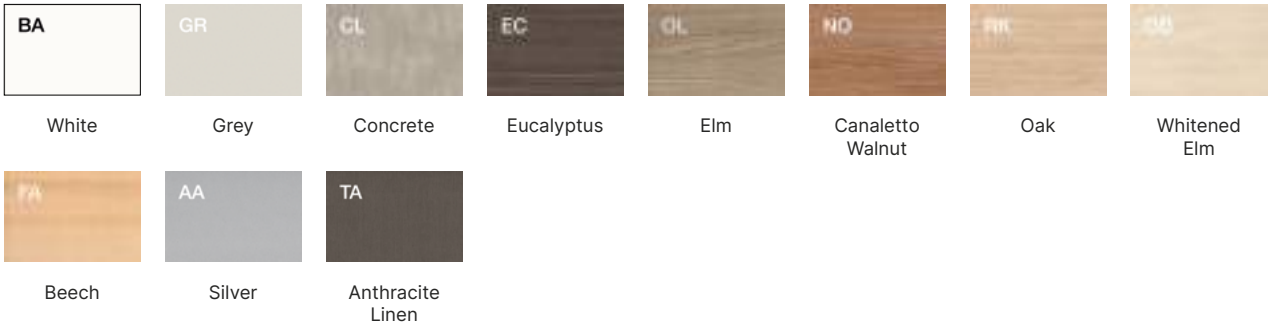

# Glass

---



# Glass finish film

---



**Product Design**  
Quadrifoglio Group R&D Dept.

**Project Direction & Coordination**  
Quadrifoglio Group Marketing & Communication Dept.

**Creative Direction**  
Willy Dalto

**Graphic Design**  
Federica Mattietto

**Images**  
Nudesign, Udine

**Color Separation & Print**  
Sincromia, Pordenone  
August 2022

**Cod. LIOCRH22**

Discover our Designers and Partners





